



ZCC Cutting Tools
Europe GmbH



Main Catalogue

Version 2023

2023

– EN –



Welcome to ZCC Cutting Tools Europe,

and welcome to the latest version of our main catalogue. The entire ZCC Cutting Tools team and I are pleased to present to you our evolving portfolio of products and solutions for optimising the quality and profitability of your production.

In combination with our Product Innovations Catalogues, which are published twice a year, this main catalogue aims at providing you with an optimal overview of our range of services and ZCC-CT's latest innovations.

'Your partner – your value' has been our claim and promise to our customers from the outset, and it's one we will continue to live up to. On this note, our offer goes far beyond the contents of this catalogue. In addition to the development and testing of your customer-specific special solutions in the Test and Demonstration Centre at our European headquarters in Düsseldorf, we also offer comprehensive services such as tool management and tool data provision, tool reconditioning and customer training according to your requirements. Feel free to contact us at any time – we are there for you.

This main catalogue addresses three key application areas. In part A right next, you will find turning tools; part B introduces you to our milling tools; and in part C is all about our drilling tools. ZCC-CT provides a separate catalogue each for tooling systems and boring tools. Please feel free to get in touch with your personal contacts or our internal sales department if you require additional catalogues and supplementary information.

We thank you for your trust and look forward to an excellent partnership.
Your team at ZCC Cutting Tools Europe is always there to support you in a spirit of collaboration.

Quanliang Zhao

Managing Director
ZCC Cutting Tools Europe GmbH



ZCC Cutting Tools Headquarters, Zhuzhou, China



ZCC Cutting Tools Europe GmbH Headquarters, Düsseldorf, Germany



European Headquarters

ZCC Cutting Tools Europe GmbH

www.zccct-europe.com

Wanheimer Str. 57, 40472 Düsseldorf, Germany

Tel.: +49 (0)211-989240-0

Fax: +49 (0)211-989240-111

E-mail: info@zccct-europe.com

Branch Office France

ZCC Cutting Tools Europe GmbH

Succursale Française

www.zccct-europe.com

14, Allée Charles Pathé, 18000 Bourges, France

Tel.: +33 (0)2 45 41 01 40

Fax: +33 (0)800 74 27 27

E-mail: ventes@zccct-europe.com

Branch Office UK

ZCC Cutting Tools Europe GmbH

UK Division

www.zccct-europe.com

4200 Waterside Centre, Solihull Parkway,

Birmingham Business Park.

Birmingham, West Midlands, B37 7YN, UK

Tel.: +44 (0)121-809 5469

Fax: +49 (0)211-989240-111

E-mail: infouk@zccct-europe.com



Catalogue copyright

©2022 ZCC Cutting Tools Europe GmbH

All rights reserved. All descriptions and illustrations are protected by copyright. The use, modification and reproduction, in whole or in part, without written permission are prohibited. We reserve the right to make technical modifications and changes to the product range. No liability for misprints and errors.



Member of Minmetals Group

Special tools – fine-tuned to your specific application

Special applications call for special solutions optimised to the task. Special tools are able to deliver real benefits from a commercial, technical or process perspective over standard tool solutions in all industry sectors. We work with you to assess the potential in each individual case, taking into account the general conditions available at your company ZCC Cutting Tools Europe's R&D department then develops a custom solution for you at our EU headquarters in Düsseldorf to keep your machining costs as low as possible.

Why opt for special tools from ZCC Cutting Tools?

We develop customised tool solutions for you for a wide range of machining operations. We work closely with you from day one to design tools optimised to meet your needs and priorities. From design and production to logistics, we draw on many years of experience to offer a full range of expert services. Take advantage of our expertise to ensure the long-term success of your company.

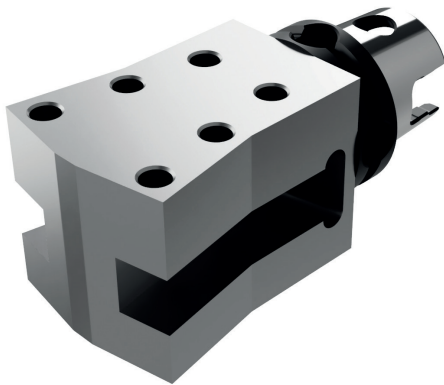

Example: Special tool holder



Example: Special solid carbide step drill

The easy way to order your custom-made special tool

Are there specific applications at your company where having custom tools tailored to your unique needs would deliver real benefits both in terms of logistics and at a technical and commercial level? ZCC Cutting Tools is there to advise and assist you during the planning, development and ordering process. Use our new online tool to request a special tool and get your personal quotation in just a few short steps (www.zccct-europe.com).

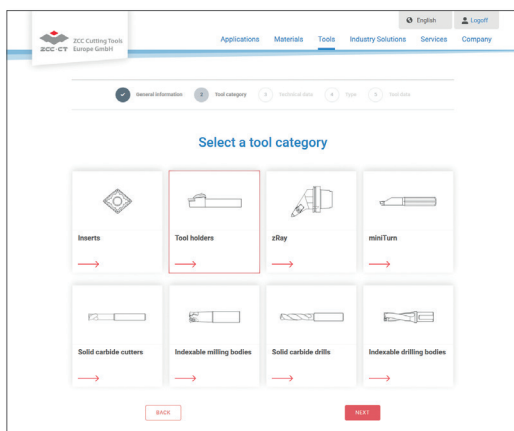

'Online tool for special tools' launch page where you can select the tool category

Selecting the tool category

Scan the QR code on this page to go directly to the launch page of our online tool where you can request the special tool you need. You can begin by selecting the tool category you need. It's that easy.

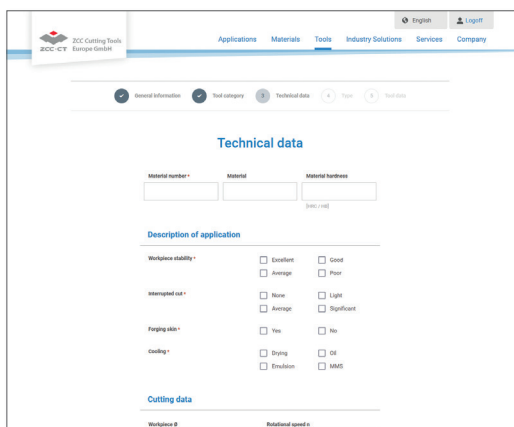

Define the relevant tool parameters

Defining the tool parameters

You are now guided step by step through the process. You can also securely upload your drawings, diagrams and 3D models (where available).

The fast and direct way to order your special tool from ZCC Cutting Tools Europe.



Now go directly to the new **special tool form** on our website and get started.



ZCC Cutting Tools Headquarters, Zhuzhou, China



Production of tool holders

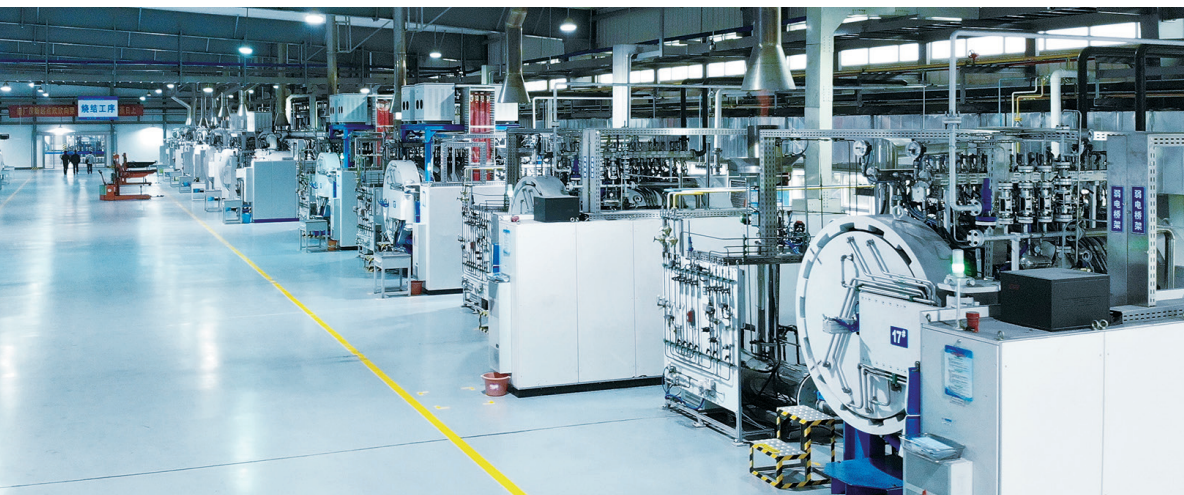

Sintering of inserts

Turning**A**

General turning

A1-A379

Parting & grooving

A380-A457

Threading

A458-A500

Milling**B**

Indexable milling

B1-B263

Solid carbide milling

B264-B526

Drilling**C**

Indexable drills

C1-C37

Solid carbide drills

C38-C151

Solid carbide reamers

C152-C171

Solid carbide threading tools

C172-C200

Technical information**D**

D1-D12

Index**E**

E1-E10

GENERAL TURNING

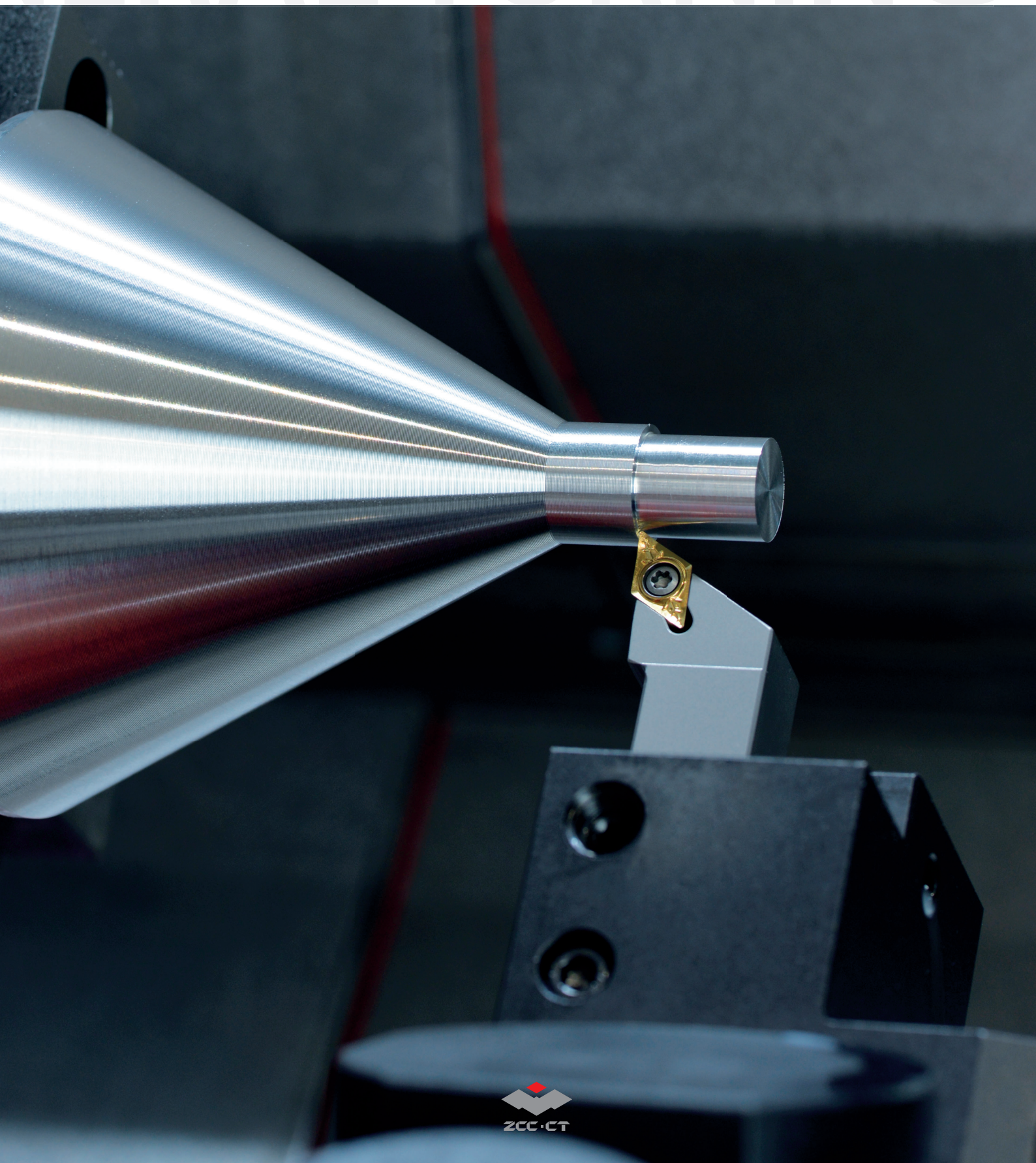



General turning

Product overview	A2-A15
Chip breaker overview	A16-A26
Application fields of chip breakers	A27-A35
Grade overview	A36-A41
Application fields of grades	A42-A47
ISO code – general turning inserts	A48-A49
Conversion table metric/imperial	A50
Negative inserts	A51-A115
Positive inserts	A116-A157
ISO code – PCBN & PCD inserts	A158-A159
PCBN & PCD inserts	A160-A197
ISO code – ceramic inserts	A198-A199
Ceramic inserts	A200-A221
External tool holder overview	A222-A227
ISO code – external tool holders	A228-A229
External tool holders	A230-A303
ISO code – external tool holders – Swiss turning	A304-A305
External tool holders – Swiss turning	A306-A313
System code – external tool holders – rail applications	A314-A315
External tool holders – rail applications	A316-A319
Boring bar overview	A320-A321
ISO code – boring bars	A322-A323
Boring bars	A324-A365
Recommended cutting data	A366-A379
Trouble shooting	A502-A503
Technical information	A505-A509
Special tools	A513

Carbide and cermet inserts

Double sided, negative – Finishing



CNEG-NF	CNMG-ADF	CNMG-DF	CNMG-EF	CNMG-SF	CNMG-XF	Edge length
12	12	09 12	09 12	09 12	12	Page
A52	A51	A51	A51	A51	A52	

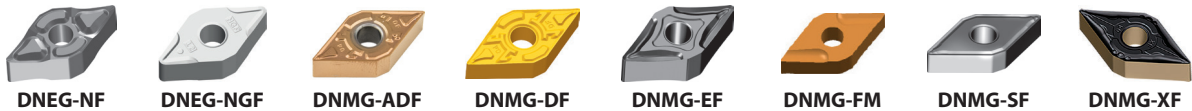

DNEG-NF	DNEG-NGF	DNMG-ADF	DNMG-DF	DNMG-EF	DNMG-FM	DNMG-SF	DNMG-XF	Edge length
15	15	15	11 15	11 15	15	11 15	11 15	Page
A66	A66	A62	A62	A66	A66	A62	A63	



SNMG-ADF	SNMG-DF	SNMG-EF	SNMG-SF	SNMG-XF	Edge length
12	12	09 12 15	09 12	12	Page
A71	A71	A72	A71	A73	



TNMG-ADF	TNMG-DF	TNMG-EF	TNMG-FM	TNMG-SF	Edge length
16	16 22	11 16 22	16	16	Page
A87	A87	A89	A90	A88	



VNEG-NF	VNEG-NGF	VNMG-ADF	VNMG-DF	VNMG-EF	VNMG-SF	VNMG-XF	Edge length
16	16	16	16	16	16	16	Page
A100	A101	A100	A100	A100	A101	A102	



WNEG-NF	WNMG-ADF	WNMG-DF	WNMG-EF	WNMG-NF	WNMG-SF	WNMG-XF	Edge length
08	08	06 08	06 08	06	06 08	06 08	Page
A106	A105	A105	A106	A106	A105	A107	

Double sided, negative, Wiper – Finishing



CNMG-WG	DNMX-WG	TNMX-WG	WNMG-WG	Edge length
12	11 15	16	08	Page
A51	A62	A87	A106	

A

Turning

B

Milling

C

Drilling

D

Technical Information

E

Index

Carbide and cermet inserts

Double sided, negative – Medium machining

									
CNMG	CNMG-DM	CNMG-EG	CNMG-EM	CNMG-NM					
12 16 19	09 12 16 19	12	12 16	12					Edge length
A61	A54	A54	A54	A56					Page
									
CNMG-PM	CNMG-TC	CNMG-TK	CNMG-XM	CNMG-ZM					
09 12 16 19	12 16	12	12 16 19	12					Edge length
A53	A56	A56	A53	A55					Page
									
DNMG-DM	DNMG-EG	DNMG-EM	DNMG-NM						
11 15	15	11 15	15						Edge length
A64	A67	A67	A67						Page
									
DNMG-PM	DNMG-TC	DNMG-TK	DNMG-XM	DNMG-ZM					
11 15	15	15	11 15	15					Edge length
A64	A67	A68	A63	A65					Page
									
SNMG	SNMG-DM	SNMG-EG	SNMG-EM	SNMG-NM					
12 25	09 12 15 19	12	12 15	12					Edge length
A83	A75	A75	A76	A77					Page
									
SNMG-PM	SNMG-TC	SNMG-TK	SNMG-XM						
09 12 15 19	12 15	12	12 15 19						Edge length
A74	A76	A76	A73						Page
									
TNMG	TNMG-DM	TNMG-EG	TNMG-EM	TNMG-PM	TNMG-TC	TNMG-XM	TNMG-ZM		
16 22 27 33	11 16 22	16	16 22	11 16 22	16 22	16 22	16		Edge length
A98	A91	A93	A93	A91	A93	A90	A92		Page

A

Turning

B

Milling

C

Drilling

D

Technical
Information

E

Index

Carbide and cermet inserts

Double sided, negative – Medium machining



VNMG	VNMG-DM	VNMG-EM	VNMG-NM	
16	16	16	16	Edge length
A103	A103	A103	A103	Page



VNMG-PM	VNMG-SNR	VNMG-TC	VNMG-XM	VNMG-ZM	
16	16	16	16	16	Edge length
A104	A104	A104	A102	A104	Page



WNMG-DM	WNMG-EG	WNMG-EM	WNMG-NM	
06 08	08	06 08	08	Edge length
A108	A108	A108	A110	Page

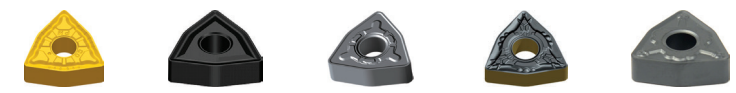

WNMG-PM	WNMG-TC	WNMG-TK	WNMG-XM	WNMG-ZM	
06 08	08	08	06 08	08	Edge length
A109	A110	A110	A107	A109	Page



RNMG	
12	Edge length
A112	Page

Double sided, negative – Medium machining to roughing



CNMA	DNMA	SNMA	SNUN	TNMA	WNMA	
12 16 19	15	12 15 19	12 19	16 22	06 08	Edge length
A61	A69	A84	A86	A99	A111	Page







Double sided, negative – Roughing



CNMG-DR	CNMG-ER	CNMG-SNR	DNMG-DR	DNMG-ER	DNMG-SNR	
12 16 19 25	12 16 19	12 16 19	15	15	15	Edge length
A57	A58	A57	A68	A69	A68	Page







Carbide and cermet inserts

Double sided, negative – Roughing







					
SNMG-DR	SNMG-ER	SNMG-SNR	TNMG-DR	TNMG-ER	TNMG-SNR
12 15 19 25	12 15 19	12	16 22 27	16 22	16
A77	A78	A78	A94	A95	A92
					Edge length
					Page





		
WNMG-DR	WNMG-SNR	
06 08	08	
A111	A109	
		Edge length
		Page

Single sided, negative – Roughing







					
CNMM	CNMM-DR	CNMM-ER	CNMM-HDR	CNMM-HPR	CNMM-LR
12 19	12 16 19 25	25	12 16 19 25	19 25	12 16 19 25
A60	A58	A58	A60	A60	A59
					Edge length
					Page

			
DNMM-DR	DNMM-ER	DNMM-HDR	DNMM-LR
15	15	15	15
A70	A70	A70	A70
			Edge length
			Page

					
SNMM	SNMM-DR	SNMM-ER	SNMM-HDR	SNMM-HPR	SNMM-LR
19 25	15 19 25	25	12 15 19 25	19 25	12 15 19 25
A85	A79	A79	A81	A82	A80
					Edge length
					Page

			
TNMM	TNMM-DR	TNMM-HDR	TNMM-LR
16 22 27	16 22 27	22 27	16
A99	A95	A97	A95
			Edge length
			Page

Special form – Finishing

					
CNMG-RF	CNMM-RF	CNMM-RH	KNUX	LNUX-RF	LNUX-RH
19	19	19	16	19 30	19 30
A114	A114	A114	A113	A115	A115
					Edge length
					Page

A

Turning

B

Milling

C

Drilling

D

Technical Information

E

Index

Carbide and cermet inserts

Positive – Fine-finishing



CCGT-SF	CCGT-USF	CPGT-SF	DCGT-SF	DPGT-SF
06 09	06 09	06 09	07 11	07 11
A116	A116	A124	A125	A131

Edge length
Page



TBGH	TCGT-SF	TPGH	TPGT-SF
06	06 09 11	09 11	09 11
A139	A140	A146	A147

Edge length
Page



VBGT-SF	VCGT-SF
11	11 16
A150	A153

Edge length
Page

Positive – Finishing



CCMT-AHF	CCMT-EF	CCMT-HF	CCMT-XF	CPMT-HF
06 09 12	06 09 12	06 09 12	06 09	06
A117	A118	A117	A118	A124

Edge length
Page



DCMT-AHF	DCMT-EF	DCMT-HF	DCMT-XF	SCMT-AHF	SCMT-EF	SCMT-HF	SCMT-XF
07 11	07 11	07 11	07 11	09	09	09	09
A125	A126	A126	A126	A134	A134	A135	A134

Edge length
Page



TCMT-AHF	TCMT-EF	TCMT-HF	TCMT-XF
11 16	09 11 16	09 11 16	09 11 16
A141	A142	A141	A141

Edge length
Page







VBET-NF	VBET-NGF	VBMT-AHF	VBMT-EF	VBMT-HF	VBMT-XF
16	16	16	11 16	11	11 16
A149	A151	A148	A148	A149	A148

Edge length
Page

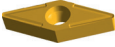

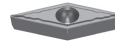

Carbide and cermet inserts

Positive – Finishing



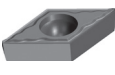

					
VCGT	VCGT-HF	VCGT-NF	VCMT-EF	VCMT-XF	
13	11	16	16	11 16	Edge length
A153	A153	A153	A156	A156	Page





Positive – Medium machining

						
CCMT-EM	CCMT-HM	CCMT-XM	CCMW	CPGW	CPMT-HM	
06 09 12	06 09 12	09 12	09 12	06	09	Edge length
A119	A120	A119	A121	A124	A124	Page









					
DCMT-EM	DCMT-HM	DCMT-XM	DCMW		
07 11	07 11	11	11		Edge length
A127	A128	A127	A129		Page

					
SCMT-EM	SCMT-HM	SPMW	SCMT-XM		
09 12	09 12	09 12	09 12		Edge length
A134	A135	A138	A135		Page

					
TCMT	TCMT-EM	TCMT-HM	TCMW	TCMT-XM	
22	09 11 16	09 11 16	16	16	Edge length
A144	A142	A143	A143	A142	Page

					
VBMT-EM	VBMT-HM	VBMT-XM	VCMT-EM	VCMT-XM	
11 16	16	16	16	16	Edge length
A151	A151	A151	A156	A156	Page

Positive – Roughing

								
CCMT-HR	CCMT-TC	DCMT-HR	RCMT · RCGT	RCMX	RCMX-PV	SCMT-HR	TCMT-HR	
06 09 12	06 09 12	11	08 10 12 16 20 25	08 10 12 16 20 25 32	32	09 12	09 11 16 22	Edge length
A121	A121	A129	A132	A133	A133	A136	A143	Page

A

Turning

B

Milling

C

Drilling

D

Technical Information

E

Index

Carbide and cermet inserts

Positive – Roughing



VBMT-HR



VBMT-SNR

16

16

A152

A152

Edge length

Page

Positive – Aluminium machining



CCGX-LC

06 09 12

A122



CCGX-LH

06 09 12

A122

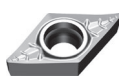

DCGX-LC

07 11

A129

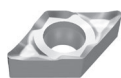

DCGX-LH

07 11

A130



RCGX-LH

08 12

A132

Edge length

Page



SCGX-LC

09 12

A136



SCGX-LH

09 12

A137



TCGX-LC

09 11 16

A145



TCGX-LH

09 11 16

A145



VCGX-LC

11 16 22

A154



VCGX-LH

11 16 22

A155

Edge length

Page

PCBN & PCD

Negative



CNGA-2

12

A160



CNGA-2W

12

A160



DNAGA-2

15

A161



SNGA-4

12

A162



TNGA-3

16

A163

Edge length

Page



VNGA-2

16

A164



WNGA-3

08

A165



ZNEX

04

A166

Edge length

Page



CNGN

09 12

A173



CNGN-M

12

A173



RNGN

09 12

A174



SNGN

12

A175



SNGN-M

12

A175



WNGN

08

A176



WNGN-M

08

A176



Edge length

Page



A
Turning
B
Milling
C
Drilling
D
Technical Information
E
Index

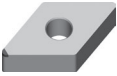

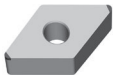

PCBN & PCD

Negative

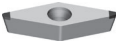
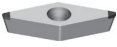



			
CNGA	DNGA	VNGA	
12	15	16	Edge length
A177	A178	A179	Page



Positive

					
CCGW-2	DCGW-2	TCGW-3	VBGW-2	VCGW-2	
06 09 12	07 11	11 16	16	11 16	Edge length
A167	A169	A170	A171	A172	Page

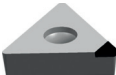
					
CCGT	CCGT-1MED	CCGT-L	CCGW	CCGW-L	
06 09 12	06 09	09 12	06 09 12	06 09 12	Edge length
A180	A180	A181	A182	A183	Page



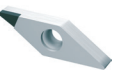
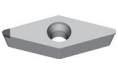

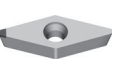

			
DCGT	DCGT-1MED	DCGW	
07 11	07 11	07 11	Edge length
A184	A185	A186	Page

					
TCGT	TCGT-1MED	TCGT-L	TCGW	TCGW-L	
11 16	11 16	11 16	11 16	11 16	Edge length
A187	A187	A188	A189	A190	Page

						
VBGT	VBGT-1MED	VBGW	VCGT	VCGT-1MED	VCGW	
11 16	16	11 16	11 16	11 16	11 16 22	Edge length
A191	A191	A192	A193	A194	A195	Page

Ceramic inserts

Negative

						
CNGA	CNGN	CNGX	DNGA	DNGN	DNGX	
12 16	12 16	12	15	15	15	Edge length
A200	A201	A203	A204	A205	A206	Page

A

Turning

Ceramic inserts

Negative



RNGA

12

A207



RNGN

06 09 12 15 19 25

A208



SNGA

12

A210



SNGN

12 15 19

A211



SNGX

12

A213



TNGA

16 22

A214



TNGN

16 22

A215

Edge length

Page

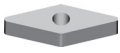

VNGA

16

A216



WNGA

08

A217

Edge length

Page

B

Milling

Positive



RCGX

06 09 12 19

A218



RPGN

12

A219



RPGX

09

A220



TPGN

11 16

A221

Edge length

Page

C

Drilling

D





Technical Information

E



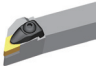



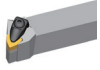

Index





External tool holders

Holder with double clamping









							
DCLNR/L	DDJNR/L	DSBNR/L	DTGNR/L	DVJNR/L	DVVNN	DWLNR/L	
95°	93°	75°	90°	93°	72.5°	95°	Angle
A230	A231	A232	A233	A235	A234	A236	Page









Holder with knee lever clamping

								
PCBNR/L	PCLNR/L	PDJNR/L	PDNNR/L	PSBNR/L	PSDNN	PSKNR/L	PSSNR/L	
75°	95°	93°	63°	75°	45°	75°	45°	Angle
A237	A238	A240	A241	A242	A244	A245	A246	Page

				
PTFNR/L	PTGNR/L	PTTNR/L	PWLNR/L	
91°	90°	60°	95°	Angle
A247	A249	A248	A251	Page

Holder with multi clamping

								
MCBNR/L	MCLNR/L	MDJNR/L	MDPNN	MRDNN	MRGNR/L	MSBNR/L	MSDNN	
75°	95°	93°	62.5°	45°	90°	75°	45°	Angle
A252	A253	A254	A255	A267	A268	A256	A259	Page

								
MSKNR/L	MSRNR/L	MTFNR/L	MTGNR/L	MTJNR/L	MTJNR/L-Z	MVJNR/L	MVVNN	
75°	75°	90°	90°	93°	93°	93°	72.5°	Angle
A258	A257	A263	A260	A261	A262	A265	A264	Page

	
MWLNR/L	
95°	Angle
A266	Page

A

Turning

B

Milling

C

Drilling

D

Technical Information

E

Index

External tool holders

Holder with screw clamping



SCACR/L	SCLCR/L	SDACR/L	SDJCR/L	SDNCN	SRDCN	SRGCR/L	SSBKR/L	
90°	95°	90°	93°	63°	45°	90°	75°	Angle
A269	A270	A271	A272	A273	A288	A289	A279	Page



SSDCN	SSKCR/L	SSSCR/L	STACR/L	STFCR/L	STGCR/L	STTCR/L	SVABR/L	
45°	75°	45°	90°	90°	90°	60°	90°	Angle
A280	A281	A282	A283	A284	A285	A286	A275	Page



SVJBR/L	SVJCR/L	SVVBN	SVVCN	SWACR/L	
93°	93°	72.5°	72.5°	90°	Angle
A274	A278	A276	A277	A287	Page

Holder with top clamping



CKJNR/L	CKNNR/L	
93°	63°	Angle
A290	A291	Page

Tool holder for ceramic inserts and solid CBN inserts









CCLNR/L	CDJNR/L	CRDNN	CSDNN	CSKNR/L	CSRNR/L	CTJNR/L	CTUNR/L	
95°	93°	45°	45°	75°	75°	93°	93°	Angle
A292	A294	A298	A299	A296	A297	A293	A295	Page

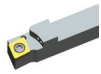

JCLNR/L	JDJNR/L	JSDNN	
95°	93°	45°	Angle
A300	A301	A302	Page

External tool holders

Swiss turning

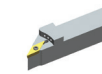



								
SCACR/L-SC	SCLCR/L-SC	SDACR/L-SC	SDHCR/L-SC	SDJCR/L-SC	SDNCN-SC	SVACR/L-SC	SVJCR/L-SC	
90°	95°	90°	107.5°	93°	63°	90°	93°	Angle
A306	A307	A308	A309	A310	A311	A312	A313	Page







Rail applications

			
RW-PCLNR/L	RW-PLANR/L	RW-PLFNR/L	
90°	90°	90°	Angle
A318	A316	A317	Page

Boring bars









Steel boring bars with knee lever clamping –

					
A***-PCLNR/L	A***-PDSNR/L	A***-PDUNR/L	A***-PSKNR/L	A***-PTFNR/L	
95°	45°	93°	75°	90°	Angle
A324	A326	A327	A329	A330	Page

						
S***-PCLNR/L	S***-PDSNR/L	S***-PDUNR/L	S***-PSKNR/L	S***-PTFNR/L	S***-PWLNR/L	
95°	45°	93°	75°	90°	95°	Angle
A324	A326	A327	A329	A330	A332	Page

Steel boring bars with screw clamping –

				
A***-SCLCR/L	A***-SDQCR/L	A***-SDUCR/L	A***-SDZCR/L	
95°	107.5°	93°	95°	Angle
A334	A336	A337	A338	Page

								
S***-SCFCR/L	S***-SCLCR/L	S***-SCLPR/L	S***-SDQCR/L	S***-SDQPR/L	S***-SDUCR/L	S***-SDUPR/L	S***-SDZCR/L	
90°	95°	95°	107.5°	107.5°	93°	93°	95°	Angle
A352	A334	A348	A336	A349	A337	A350	A338	Page

A

Turning

B

Milling

C

Drilling

D

Technical Information

E





Index

A

Turning







Boring bars

Steel boring bars with screw clamping –

				
A***-SSKCR/L	A***-STFCR/L	A***-SVQBR/L	A***-SVUBR/L	
75°	90°	107.5°	93°	Angle
A339	A341	A345	A346	Page

B

Milling







							
S***-SSKCR/L	S***-STFCR/L	S***-STUPR/L	S***-SVQBR/L	S***-SVQCR/L	S***-SVUBR/L	S***-SVUCR/L	
75°	90°	93°	107.5°	107.5°	93°	93°	Angle
A339	A341	A351	A345	A343	A346	A344	Page

C

Drilling

Solid carbide boring bars with screw clamping –

							
C***-SCLPR/L	C***-SDQPR/L	C***-SDUPR/L	C***-STUPR/L	C***-SVQCR/L	C***-SVUCR/L	C***-SZLNR/L	
A354	A356	A358	A360	A363	A364	A365	Page

							
E***-SCLCR/L	E***-SCLPR/L	E***-SDQCR/L	E***-SDUCR/L	E***-STFCR/L	E***-STFPR/L	E***-SVUCR/L	
95°	95°	107.5°	93°	90°	90°	93°	Angle
A355	A354	A357	A359	A361	A362	A364	Page

D

Technical Information

E

Index

Notes

A series of horizontal dotted lines for taking notes, spanning the width of the page.

A

Turning

B

Milling

C

Drilling

D

Technical
Information

E

Index

A

Turning

Negative inserts

Finishing

XF

P



Double-sided chip breaker for finishing operations in the P application field. Superb chip control with low cutting forces.

B

Milling

RF

P



Double-sided chip breaker for applications from finishing to medium machining.

C

Drilling

SF

P

M

K



Double sided chip breaker in combination with cermet grades. Geometry with high sharpness for improved chip control and great surface quality. Ideal for machining with small cutting depths and feed rates.

D

Technical Information

DF

P

K



Double sided chip breaker with good chip control. Suitable for finishing and medium machining of steel and cast iron.

ADF

P

M



Ground, double sided chip breaker with good chip control. Wide range of application due to excellent balance of sharpness and cutting edge stability.

E

Index

Negative inserts

Finishing

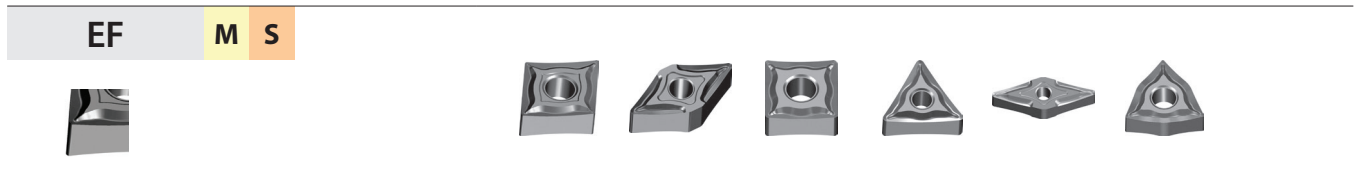

Double sided chip breaker with sharp cutting edge and large rake angle for finishing of stainless steel.

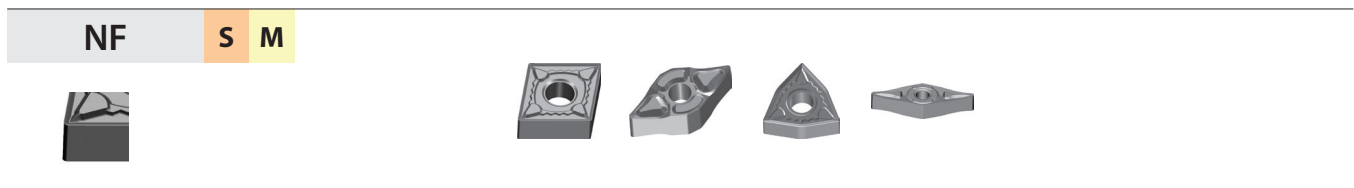

Double sided chip breaker with ground cutting edge and large rake angle for finishing. E-tolerance for high repeatability.

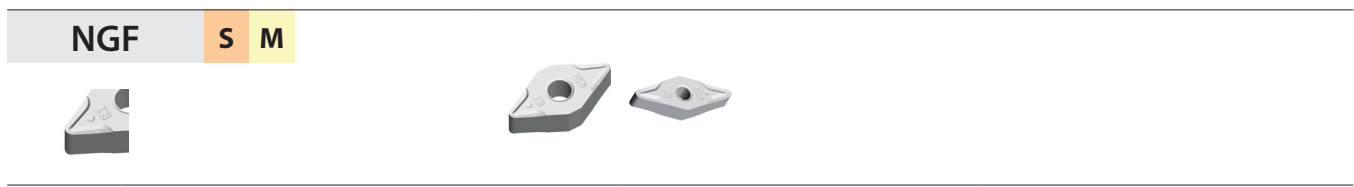

Double sided chip breaker with ground cutting edge and large rake angle for finishing. E-tolerance for high repeatability.

Wiper



Double sided chip breaker with wiper geometry. Allows to double the feed rate and improves the surface quality.

Medium machining



Double-sided chip breaker for medium machining operations in the P application field. Superb chip control at high and low feed rates.

A

Turning

B

Milling

C

Drilling

D

Technical Information

E

Index

A

Turning

Negative inserts

Medium machining

DM P K



Double sided chip breaker for medium machining. Wide range of application due to excellent balance of sharpness and cutting edge stability.

B

Milling

ZM P



Double sided chip breaker for medium machining. Wide range of application due to stable cutting edge and large rake angle. Very suitable for machining of steel.

C

Drilling

PM P K



Double sided chip breaker for medium machining. Wide range of application in steel and cast iron.

D

Technical Information

TC K P



Double sided chip breaker with surrounding cutting edge. Process reliable machining due to highest cutting edge stability.

TK K

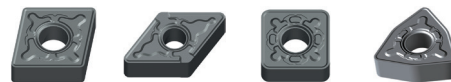

Double-sided chip breaker for medium machining operations in the K application field. Optimum combination of impact resistance and cutting edge sharpness.

E

Index

Negative inserts

Medium machining

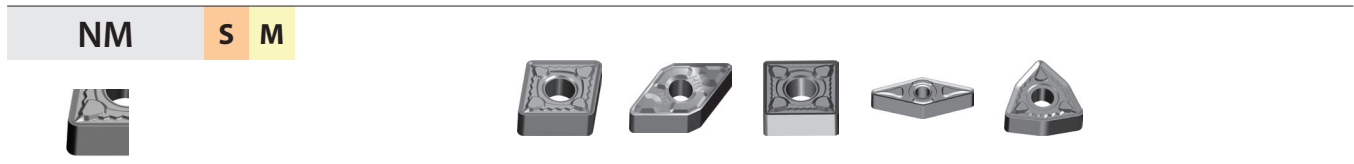

Double sided chip breaker with ground cutting edge and large rake angle for medium machining of heat-resistant materials.

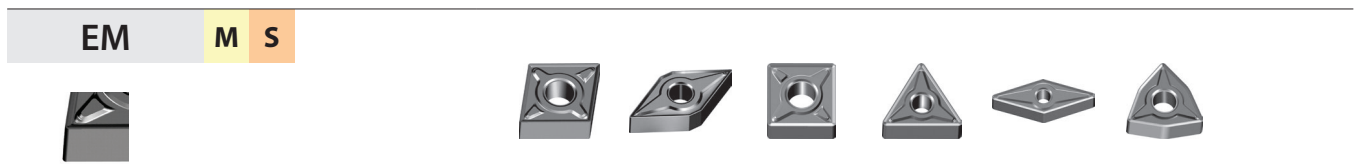

Double sided chip breaker with sharp cutting edge and large rake angle. Process reliable medium machining of stainless steel.

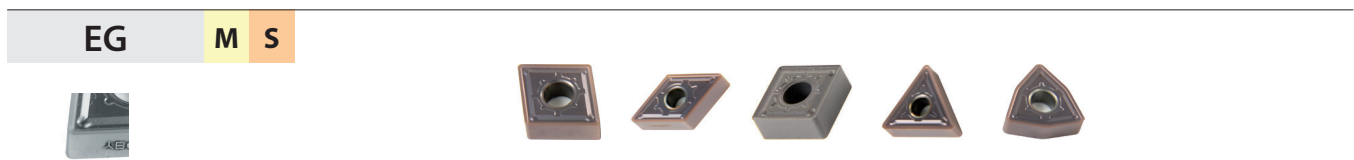

Double sided chip breaker with grinded cutting edge and large rake angle. Wide range of application for medium machining of stainless steel.



Double sided chip breaker with surrounding cutting edge for universal machining of steel and cast iron.

Roughing

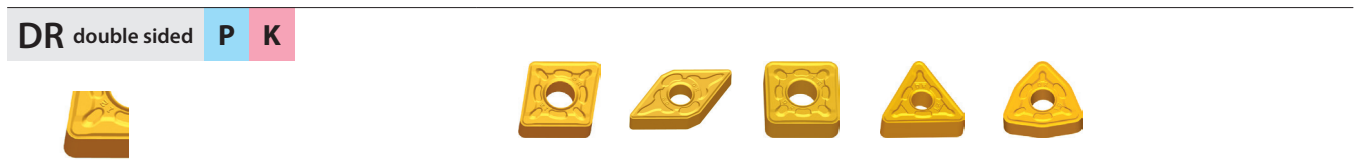

Double sided chip breaker with positive rake angle and stable cutting edge for light to medium roughing of steel and cast iron.

A

Turning

B

Milling

C

Drilling

D

Technical Information

E

Index

A

Negative inserts

Roughing

DR single sided **P** **K**



Single sided chipbreaker with positive rake angle and stable cutting edge for light to medium roughing of steel and cast iron.

Turning

B

RH **P**



Double-sided chip breaker for applications from medium machining to roughing.

Milling

C

LR **P** **M**



Single sided chip breaker with curved cutting edge and unique bumpy geometry. Low cutting pressure for process reliable machining. Light roughing of steel and stainless steel.

Drilling

D

ER double sided **M** **S**



Double sided chip breaker with large rake angle for low cutting forces. Suitable for roughing of stainless steel.

Technical Information

E

ER single sided **M** **S**



Single sided chip breaker with large rake angle for low cutting forces. Suitable for roughing of stainless steel.

Index

Negative inserts

Roughing



Single sided chip breaker with high cutting edge stability and deformation resistance. Excellent for roughing with high cutting depths in steel and stainless steel.

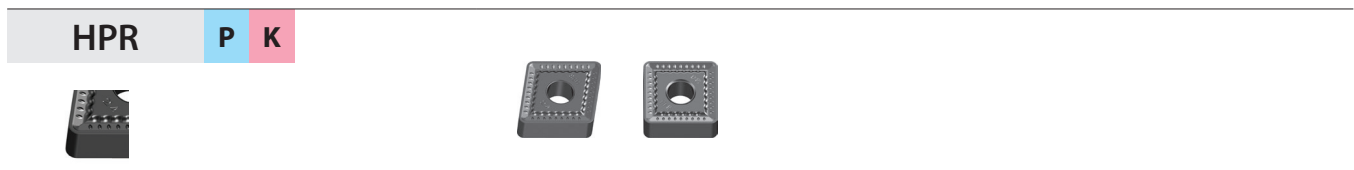

Single sided chip breaker with high cutting edge stability and large chip space. Excellent for heavy roughing in steel and cast iron.



Double sided insert without chip breaker. Stable cutting edge design, due to missing microgeometry. Excellent for roughing in cast iron.

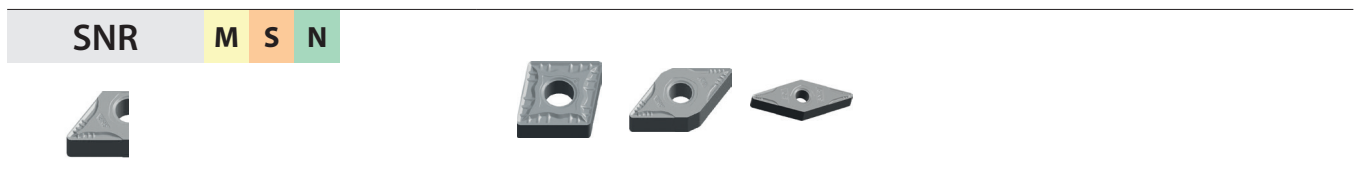

Double sided chip breaker for roughing. Wide range of application due to excellent balance of sharpness and cutting edge stability.

PCBN & PCD inserts

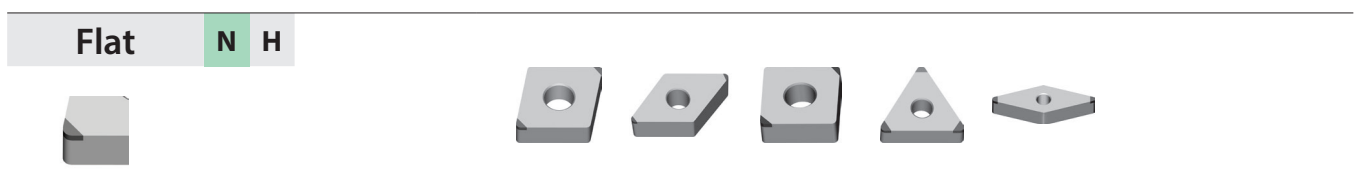

With brazed CBN or PCD cutting edge. For machining of hardened steel (CBN) or non-ferrous metals (PCD).

A

Turning

B

Milling

C

Drilling

D

Technical Information

E

Index

A

Turning

Negative inserts

PCBN & PCD inserts

Flat H K



Solid CBN insert for machining of steel and cast iron.

B

Milling

Ceramic inserts

Flat K H



Ceramic inserts for machining of low hardened steel and cast iron.

C

Drilling

Positive inserts

Fine-finishing

USF P M



Single sided chip breaker for fine finishing. Sharp cutting edge with large hollow flute, excellently suitable for machining small work pieces. G-tolerance for high repeatability.

D

Technical Information

R/L P M



Single sided chip breaker for fine finishing. Excellent for high surface quality. G-tolerance for high repeatability.

E

Index

SF P M

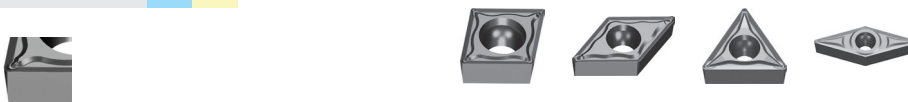

Single sided chip breaker in combination with cermet grades. Geometry with high sharpness for improved chip control and great surface quality. Ideal for machining with small cutting depths and feed rates.

Positive inserts

Finishing



Single-sided chip breaker for finishing operations in the P application field. Superb chip control with low cutting forces.



Single sided chip breaker with good chip control. Suitable for finishing to medium machining of steel and cast iron.



Ground, single sided chip breaker with good chip control. Wide range of application due to excellent balance of sharpness and cutting edge stability.

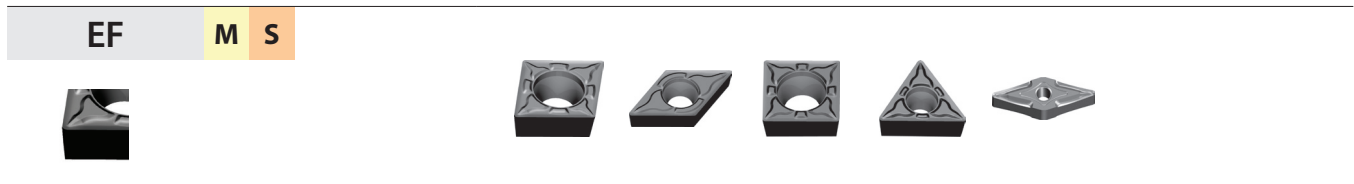

Single sided chip breaker with sharp cutting edge and large rake angle for finishing of stainless steel.

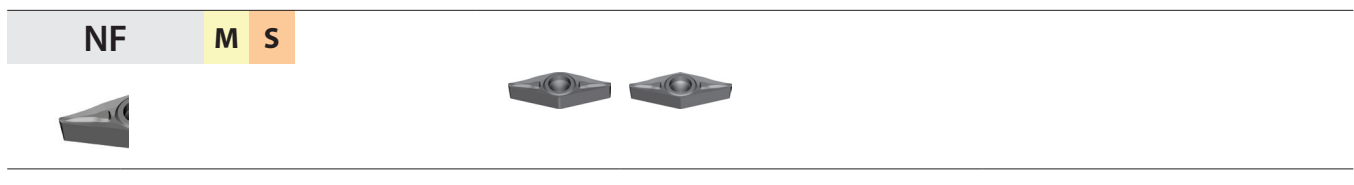

Single sided chip breaker with ground cutting edge and large rake angle for finishing. E-tolerance for high repeatability.

A

Turning

B

Milling

C

Drilling

D

Technical Information

E

Index

A

Turning

Positive inserts

Finishing

NGF M S



Single sided chip breaker with ground cutting edge and large rake angle for finishing. E-tolerance for high repeatability.

B

Milling

Medium machining

XM P



Single-sided chip breaker for medium machining operations in the P application field. Superb chip control at high and low feed rates.

C

Drilling

TC K P



Single sided chip breaker with encircling cutting edge. Process reliable machining due to highest cutting edge stability.

D

Technical Information

HM P K

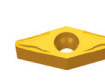

Single sided chip breaker for medium machining. Wide range of application due to excellent balance of sharpness and cutting edge stability.

E

Index

EM M S

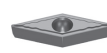
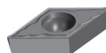
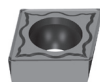

Single sided chip breaker with sharp cutting edge and large rake angle. Process reliable medium machining of stainless steel.

Positive inserts

Medium machining

Basic P K



Single sided chip breaker with encircling cutting edge for universal machining of steel and cast iron.

Roughing

Flat K



Single sided insert without chip breaker. Stable cutting edge design due to missing microgeometry. Excellent for roughing in cast iron.

HR P K



Single sided chip breaker with positive rake angle and stable cutting edge for light to medium roughing of steel and cast iron.

SNR S M



Single sided chip breaker for roughing. Wide range of application due to excellent balance of sharpness and cutting edge stability.

Basic P K



Single sided chip breaker with encircling cutting edge for universal machining of steel and cast iron.

A

Turning

B

Milling

C

Drilling

D

Technical Information

E

Index

A

Turning

Positive inserts

Aluminium machining

LC N



Single sided chip breaker with excellent cutting edge design. Sharp cutting edge with positive rake angle. G-tolerance for high repeatability.

B

Milling

LH N



Single sided chipbreaker for machining of cast aluminium alloys. Sharp cutting edge with positive rake angle. G-tolerance for high repeatability.

PCBN & PCD inserts

C

Drilling

Flat N H



With brazed CBN or PCD cutting edge. For machining of hardened steel (CBN) or non-ferrous metals (PCD).

D

Technical Information

MED N



Laser-cut chip breaker for finishing and medium machining operations.

E

Index

General turning

Application fields of chip breakers

Example

Insert: CNMG120408-DF
 Holder: PCLNL2525M12
 Material: C45 steel
 V_C : 200 m/min

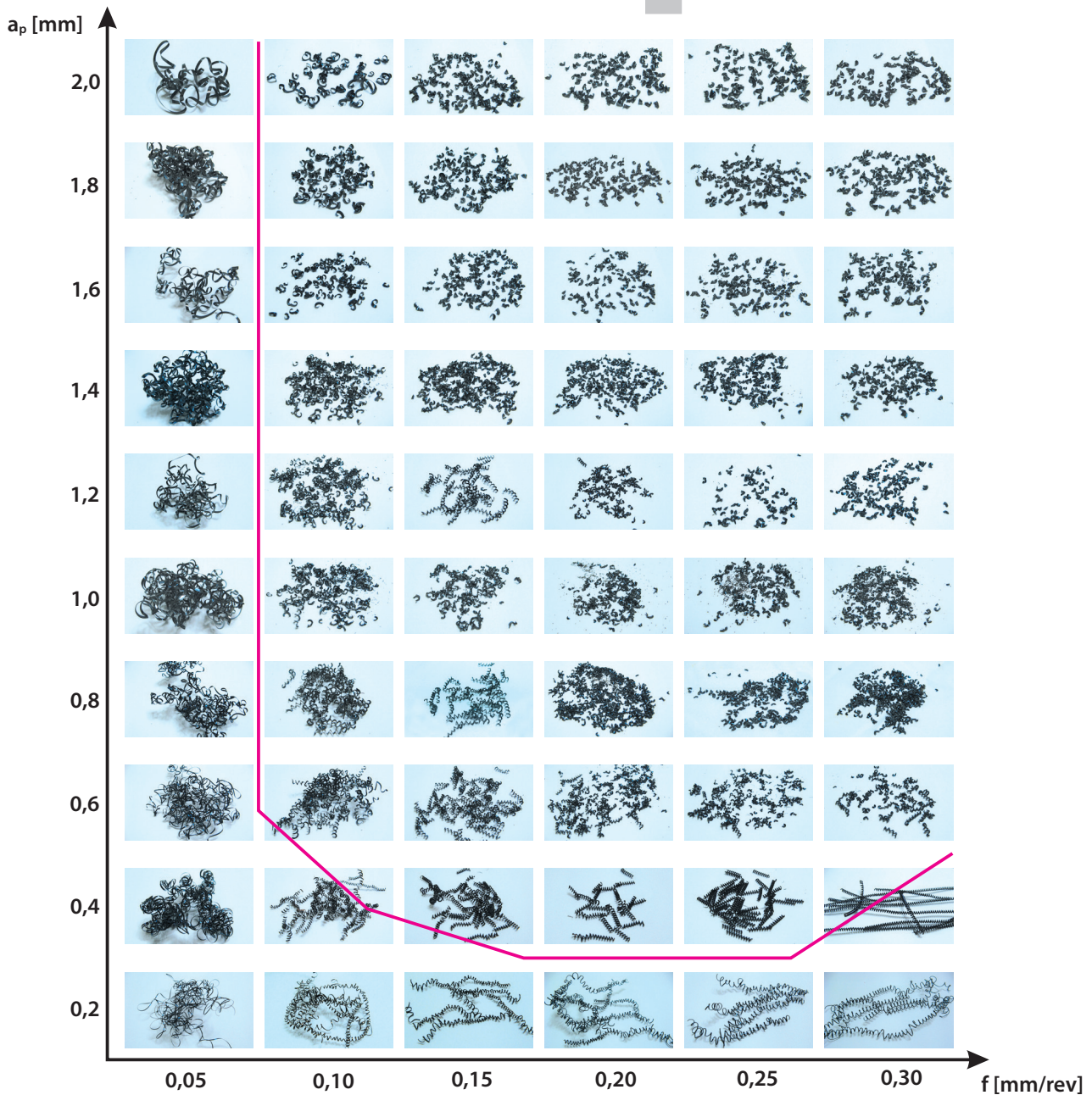
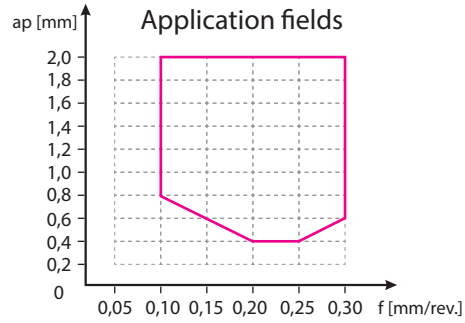

A

Turning

B

Milling

C

Drilling











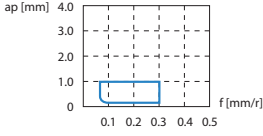
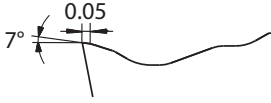

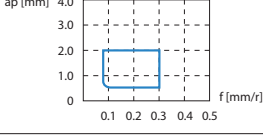
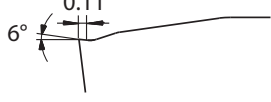

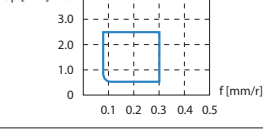
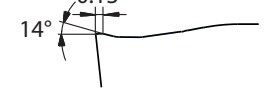
D

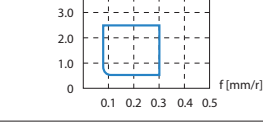
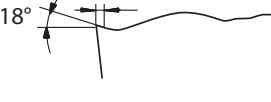
Technical Information

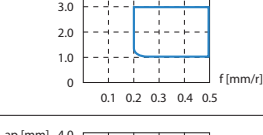
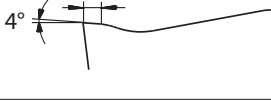
E

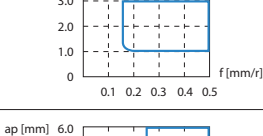
Index

P Positive inserts

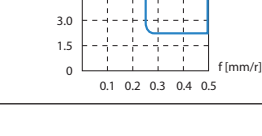
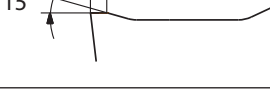
Chip breaker	Application		Application fields	Cutting edge design
SF	Fine-finishing			
HF	Finishing	 		
AHF	Finishing	 		
XF	Finishing	 		
HM	Medium machining	 		
XM	Medium machining	 		
HR	Roughing	  		

A

Turning

B

Milling

C

Drilling

D

Technical Information

E

Index

P Negative inserts

Chip breaker	Application	Application fields	Cutting edge design
SF	Fine-finishing		
DF	Finishing		
XF	Finishing		
ADF	Finishing		
DM	Medium machining		
PM	Medium machining		
ZM	Medium machining		
XM	Medium machining		
WG	Medium machining		
Basic	Medium machining		
DR	Roughing		

A

Turning

B

Milling

C

Drilling

D

Technical Information

E

Index





P Negative inserts

Chip breaker	Application		Application fields	Cutting edge design
DR (single sided)	Roughing			
LR (single sided)	Roughing			
HDR (single sided)	Roughing			
HPR (single sided)	Roughing			



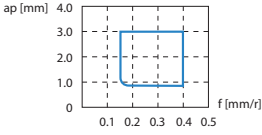
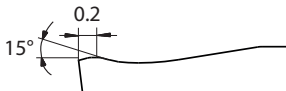

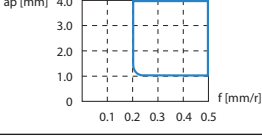

P Negative inserts (rail technology)

Chip breaker	Application		Application fields	Cutting edge design
RF	Finishing			
RH	Roughing			

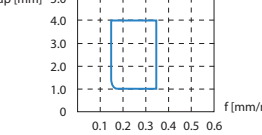
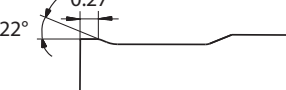
K Positive inserts

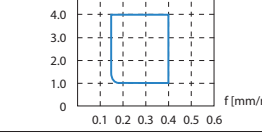
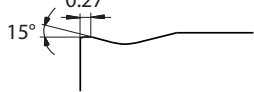
Chip breaker	Application		Application fields	Cutting edge design
TC	Medium machining			
Flat	Roughing			

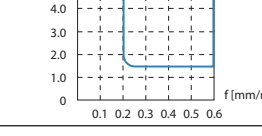
K Negative inserts

Chip breaker	Application		Application fields	Cutting edge design
TK	Medium machining			
TC	Medium machining			
Flat	Roughing			

A

Turning

B

Milling

C

Drilling







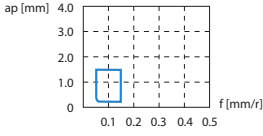

D

Technical Information



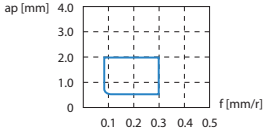
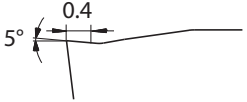



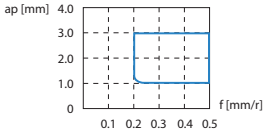
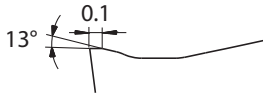



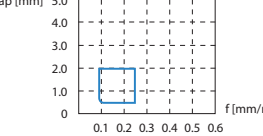
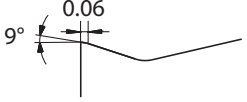

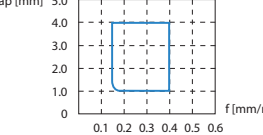
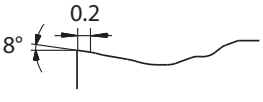
E

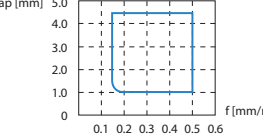
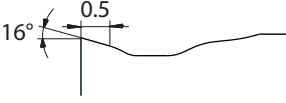
Index

M Positive inserts

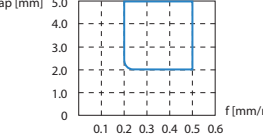
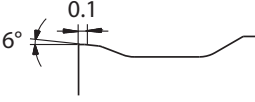
Chip breaker	Application		Application fields	Cutting edge design
USF	Fine-finishing			
EF	Finishing	 		
EM	Medium machining	  		

M Negative inserts

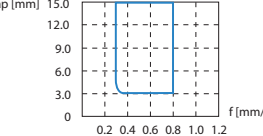
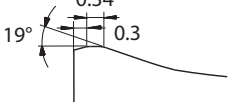
Chip breaker	Application		Application fields	Cutting edge design
EF	Finishing			
EM	Medium machining	 		
EG	Medium machining	 		
ER	Roughing	  		
ER (single sided)	Roughing	  		

A

Turning

B

Milling

C

Drilling







D

Technical Information

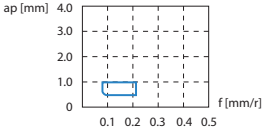

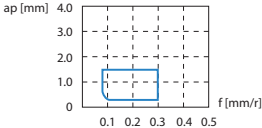

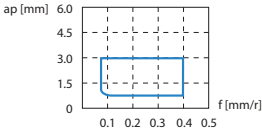

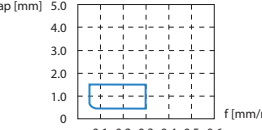
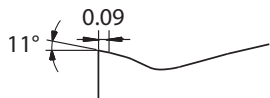

E

Index

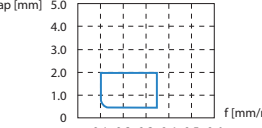
S Positive inserts

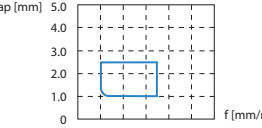
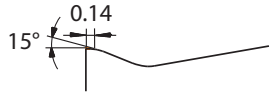
Chip breaker	Application		Application fields	Cutting edge design
NF	Finishing			
NGF	Finishing			
SNR	Roughing			

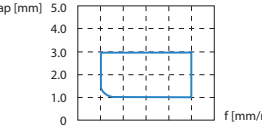
S Negative inserts

Chip breaker	Application		Application fields	Cutting edge design
NF	Finishing			
NGF	Medium machining			
NM	Medium machining			
SNR	Roughing			

A

Turning

B

Milling

C

Drilling



D

Technical Information

E

Index

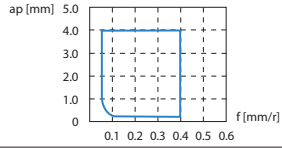
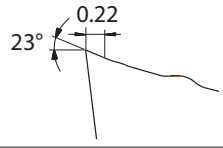
N Positive inserts

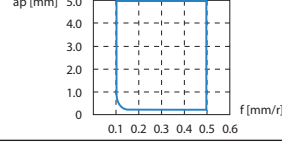
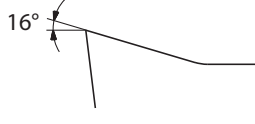
Chip breaker	Application		Application fields	Cutting edge design
LC	Finishing			
LH	Finishing			

A

Turning

B

Milling

C

Drilling

D

Technical Information

E

Index

Coated cemented carbide CVD

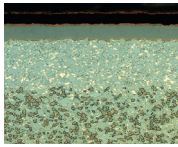
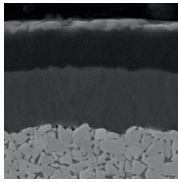
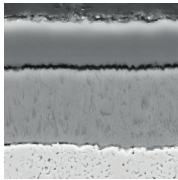
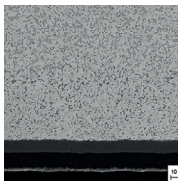
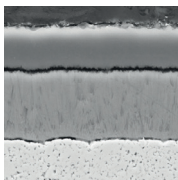
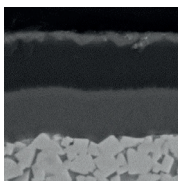
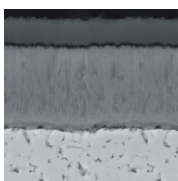
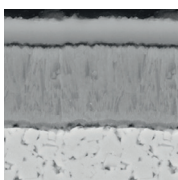
Grade	ISO	Micro structure	Grade description
A		Turning	
YBC103	P05 – P15		P10 grade with excellent wear resistance at higher cutting speeds. Latest sinter processes and CVD coating technologies enable a wide range of applications in the P material range.
B		Milling	
YB6315	P05 – P20		CVD coated P10–P20 carbide grade for finishing to medium operation of steel, casting steel and high chrome material. Outstanding performance under high cutting speed and temperature with excellent wear resistance.
YBC152	P10 – P20		CVD coated P10–P20 carbide grade for finishing to medium operation of steel and casting steel. Outstanding performance under higher cutting speed and temperature with excellent wear resistance.
C		Drilling	
YBC203	P15 – P25		P20 grade with exceptional wear resistance and toughness for reliable machining operations. Ultra-modern sintering technique and CVD coating technologies allow for a wide range of applications in the P material range.
YBC252	P20 - P35		CVD coated P20–P35 carbide grade for medium operation to roughing of steel and casting steel. Optimal performance of wear resistance and toughness for a wide application field.
D		Technical Information	
YBC352	P20 - P40		CVD coated P20–P40 carbide grade for roughing operation of steel and casting steel. Optimal performance of wear resistance and toughness for a wide application field.
YBM153	M10 - M25		CVD coated M10–M25 carbide grade for finishing to medium application in stainless steel. High wear resistance and capability against plastic deformation at higher cutting speed.
E		Index	
YBM253	M15 - M35		CVD coated M15–M35 carbide grade for medium to roughing operation in stainless steel with wide application field. High wear resistance and capability against plastic deformation at higher cutting speed.

Coated cemented carbide CVD

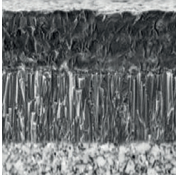
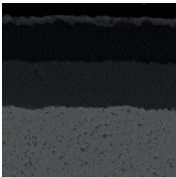
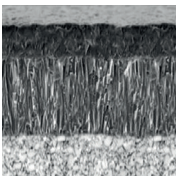
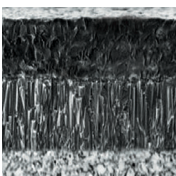
Grade	ISO	Micro structure	Grade description
YBD102	K05 - K20		CVD coated K05-K20 carbide substrate. Optimized for medium operation of cast iron, special nodular cast iron and hard steel at high cutting speed.
YB7315	K10 - K25		CVD coated K10-K25 carbide substrate. Optimized for medium to roughing operation of cast iron. Improved wear resistance and toughness at high cutting speed.
YBD152	K10 - K25		CVD coated K10-K25 carbide substrate. Optimized for medium to roughing operation of cast iron. Good wear resistance and toughness at higher cutting speed.
YBD152C	K10 - K25		Thick Al ₂ O ₃ CVD coated K05-K25 carbide substrate. Optimized for medium to roughing operation of cast iron. Higher wear resistance and toughness at higher cutting speed in combination with TC chip breaker.

Coated cemented carbide PVD

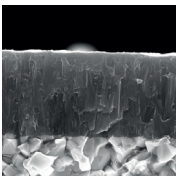
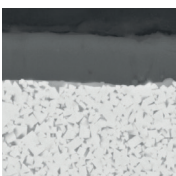
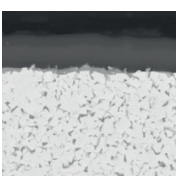
Grade	ISO	Micro structure	Grade description
YBG101	N05 - N20		PVD coated N05-N20 carbide substrate for finishing to semi-finishing in aluminium materials. Coating only on the top face, in combination with the aluminium chip breakers, prevents built-up edges and gives a smooth cut.
YBG102	S05 - S15		PVD coated S05-S15 carbide substrate for finishing to medium application of super alloy material, stainless steel and aluminum. Good wear resistance in a wide application field.
YBG105	S05 - S20		PVD multilayer coated S05-S20 carbide substrate for finishing to medium application of super alloy material but also stainless steel. Good wear resistance and thermal stability in a wide application field.

A

Turning

B

Milling

C

Drilling

DTechnical
Information**E**

Index

Coated cemented carbide PVD

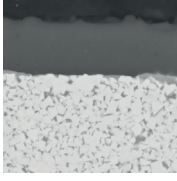
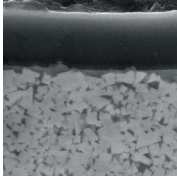
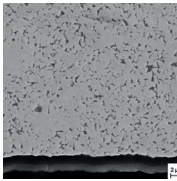
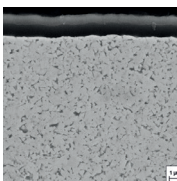
Grade	ISO	Micro structure	Grade description
YBG205	P10 - P30 M20 - M40 S15-S25		PVD multilayer coated P10–P30/M20–M40/S15–S25 carbide substrate for finishing to medium machining of stainless steel, super alloys and steel (milling). Excellent wear resistance and thermal stability in a wide range of applications.
YB9320	P10 - P30 M10 - M25		PVD multilayer coated P10–P30/M10–M25 carbide substrate for finishing to medium machining of stainless steel, super alloys and steel (grooving/milling). Optimised coating stability for higher wear resistance and thermal stability in a wide range of applications.
YPD201	S20 - S30		Carbide grade for semi-roughing to chip breaking of high-strength and high-alloy materials. High-performance grade with high wear resistance. Balanced hardness and internal stress ratio provide a wide range of applications.
YBS103	S10 - S20		Turning grade for processing nickel-base materials. A special carbide substrate and the latest PVD coating technology enable a very good wear behaviour and high thermal stability.

Ceramic

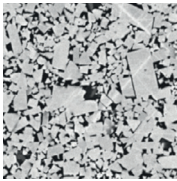
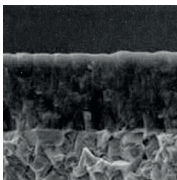
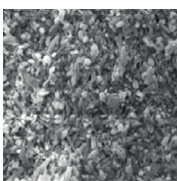
Grade	ISO	Micro structure	Grade description
CA1000	K10 - K25 H10 - H25		Uncoated H10–H25/K10–K25 mixed ceramic grade for finishing to medium operation in hardened steel and nodular cast iron. Good wear resistance and toughness.
CM1000	K10 - K25 H10 - H25		Coated H1–H25/K10–K25 mixed ceramic grade for finishing to medium operations in hardened steel, tool steel, HSS material and nodular cast iron. Good wear resistance and toughness.
CN1000	K05 - K15		Uncoated K05–K15 Si3N4 ceramic grade for finishing to medium operation in grey cast iron. Good wear resistance and thermal stability.

A
Turning

B
Milling

C
Drilling

D
Technical Information

E
Index

Ceramic

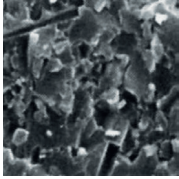
Grade	ISO	Micro structure	Grade description
CS1000	S05 – S20		Uncoated SiAlON ceramic grade for medium machining to roughing of nickel- and cobalt-based alloys at medium to low cutting speeds.
CW1400	S10 – S20 H10-H20		Uncoated whisker ceramic grade for medium and low speed cutting in HSS steel, high chrome steel and cobalt-base alloy also with interrupted cut. Good wear resistance, notch wear resistance and thermal stability.
CW1800	S10 – S25		Uncoated whisker ceramic grade for finishing to rough operations in Ni-base alloy material like Inconel, Nimonic or Hastelloy. Good wear resistance, notch wear resistance and thermal stability.

Uncoated cemented carbide

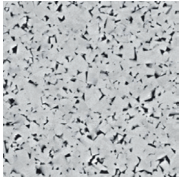
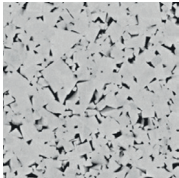
Grade	ISO	Micro structure	Grade description
YD101	N05 - N20 K05 - K20		Uncoated N05–N20/K05–K20 carbide substrate for fine to medium application in aluminum and other material.
YD201	N10 - N30 K10 - K30		Uncoated N10–N30/K10–K30 carbide substrate for medium application in aluminum and other material.

CBN

Grade	ISO	Micro structure	Grade description
YCB112	S10 – S20		Uncoated, brazed S10–S20 CBN grade for fine finishing operations on hardened steel and super alloys. Excellent wear resistance and thermal stability.

A

Turning

B

Milling

C

Drilling

DTechnical
Information**E**

Index

A	Turning	C	D	E
B	Milling	C	D	E
C	Drilling	C	D	E
D	Technical Information	C	D	E
E	Index	C	D	E

CBN

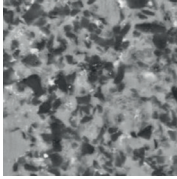
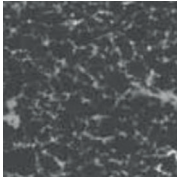
Grade	ISO	Micro structure	Grade description
YCB113	H01 - H10		Uncoated, brazed H01–H10 CBN grade for fine finishing operation in hardened steel with continuous cut. High wear resistance and productivity at higher cutting speed.
YCB121	H10 - H25		Uncoated, brazed H10–H25 CBN grade for fine to medium application in hardened steel from continuous to light interrupted cut. Good wear resistance and toughness for universal use.
YCB131	H20 - H35		Uncoated, brazed H20–H35 CBN grade for fine to medium application in hardened steel with interrupted cut. Good wear resistance and optimized toughness for safe process.
YCB113C	H01 - H10		Coated, brazed H01–H10 CBN grade for fine finishing operations on hardened steel with a continuous cut. High wear resistance and productivity at higher cutting speeds
YCB121C	H10 - H25		Coated, brazed H10–H25 CBN grade for fine to medium machining operations on hardened steel with a continuous to partially interrupted cut. Good wear resistance and toughness for universal application.
YCB131C	H20 - H25		Coated, brazed H20–H35 CBN grade for fine to medium machining operations on hardened steel with an interrupted cut. Good wear resistance and optimum toughness for reliable operations.
YCB215	K10 - K20		Uncoated, brazed K10–K20 CBN grade for fine to medium machining operations on cast iron. Excellent wear resistance and thermal conductivity.
YZB630	H20 - H30		Uncoated H20–H30 solid CBN grade for medium machining operations on hardened steel with a slight to medium interrupted cut. Excellent combination of wear resistance and thermal stability.

CBN

Grade	ISO	Micro structure	Grade description
YZB630C	H20 - H30		Coated H20–H30 solid CBN grade for medium machining operations on hardened steel with a slight to medium interrupted cut. Excellent combination of wear resistance and thermal stability.

YZB223	K10 - K25		Uncoated H10–H25/K10–K25 mixed ceramic grade for finishing to medium operation in hardened steel and nodular cast iron. Good wear resistance and toughness.
---------------	-----------	--	---

PCD

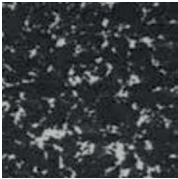
Grade	ISO	Micro structure	Grade description
YCD421	N01 - N10		Uncoated, brazed N01–N10 PCD grade for fine finishing operation of aluminum alloys less than 12 % Si, composites, copper/magnesium and other alloys. Medium grain size grade with good wear resistance for a wide application field.

Cermet

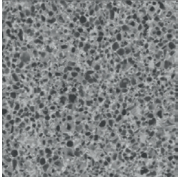
Grade	ISO	Micro structure	Grade description
YNG151	P05 - P15		Uncoated P05–P15 cermet grade for fine finishing operation of steel and stainless steel. Good resistance against plastic deformation for good surface finishing.

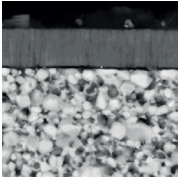
YNG151C	P05 - P15		PVD coated P05–P15 cermet grade for fine finishing operation of steel and stainless steel. Good wear resistance and capability against plastic deformation for good surface roughness.
----------------	-----------	---	--

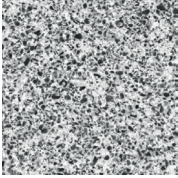
YNT251	P10 - P25		Uncoated P10–P25 cermet grade for fine finishing to medium operation of steel and stainless steel. Good wear resistance and toughness. Suitable also in light interrupted cut.
---------------	-----------	---	--

A

Turning

B

Milling

C

Drilling

DTechnical
Information**E**

Index

CVD coated carbide grades for steel

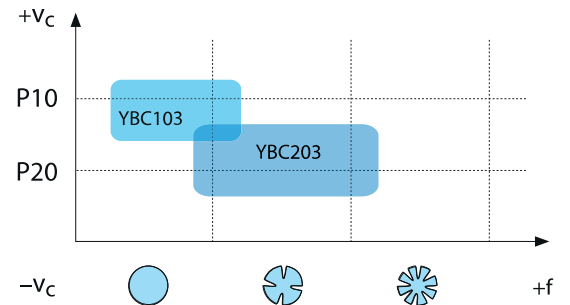
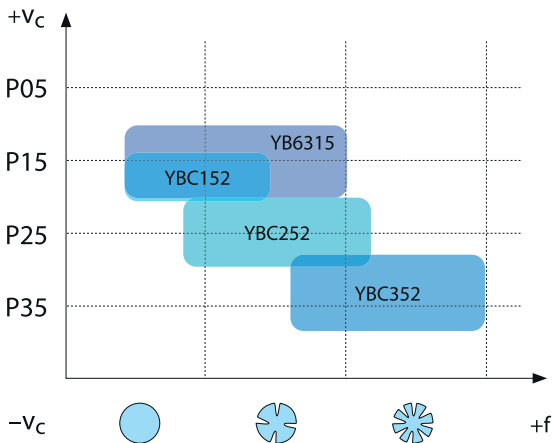

Cermet grades for steel

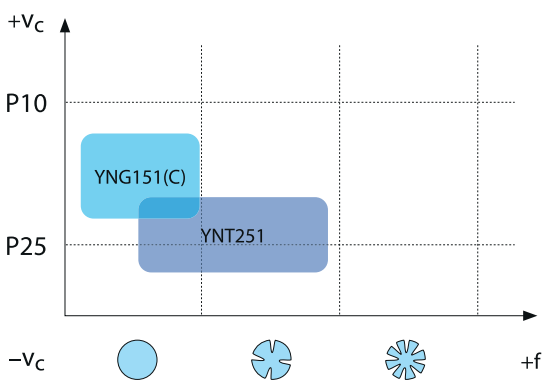

CVD coated carbide grades for stainless steel

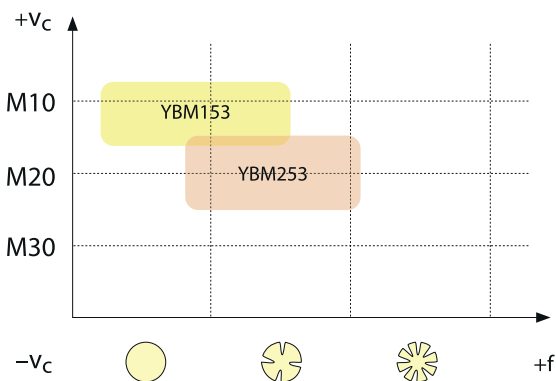

A

Turning

B

Milling

C

Drilling

D

Technical Information

E

Index

PVD coated carbide grades for stainless steel

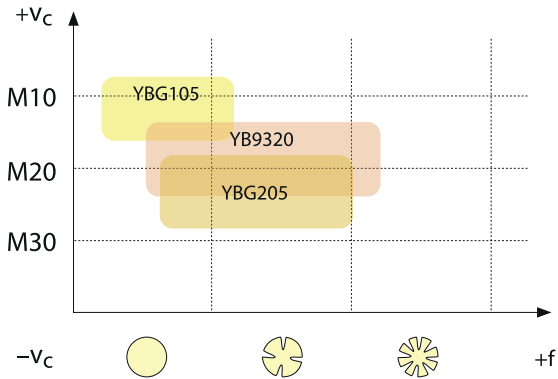

CVD coated carbide grades for cast iron

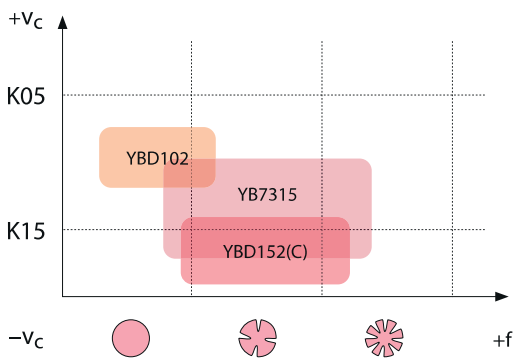

CBN grades for cast iron

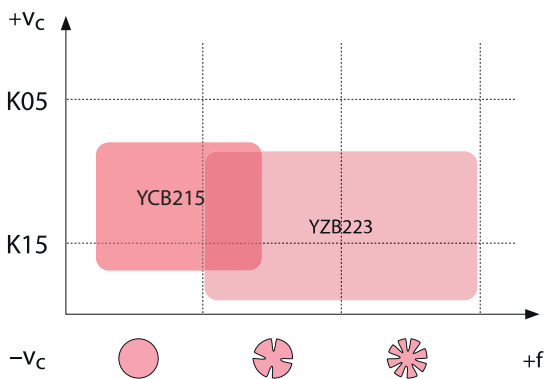

A

Turning

B

Milling

C

Drilling

D

Technical Information

E

Index

A

Turning

Ceramic grades for cast iron

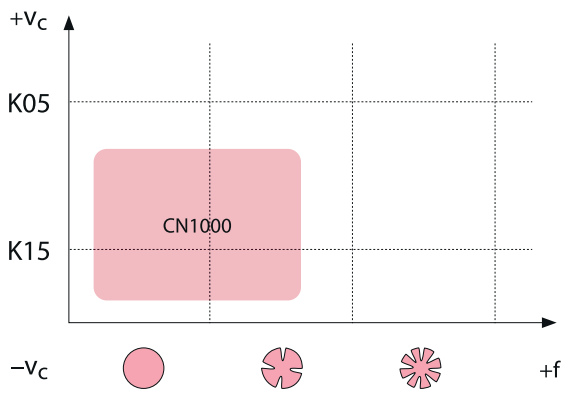

B

Milling

PVD coated carbide grades for superalloys

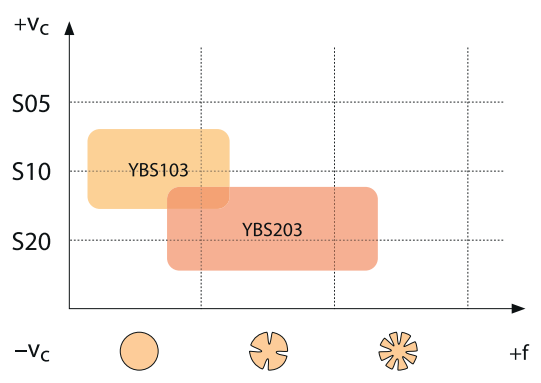
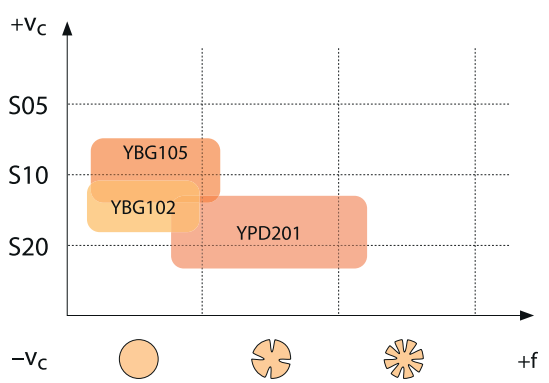

C

Drilling

D

Technical Information

Ceramic grades for cobalt base alloys/HSS

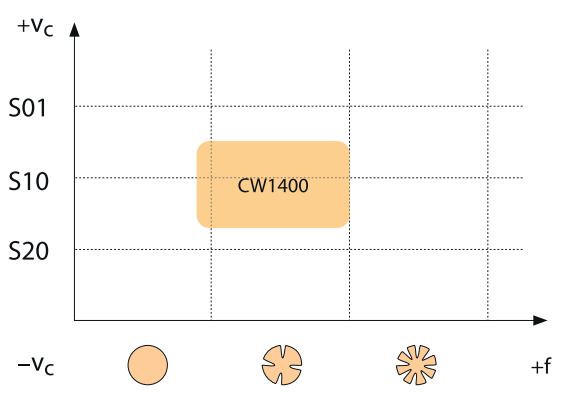

E

Index

Ceramic grades for nickel base alloys

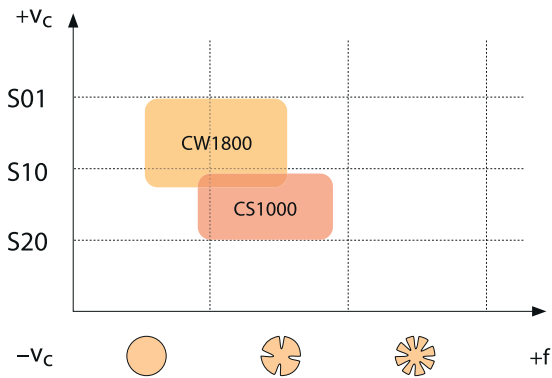

CBN grades for superalloys

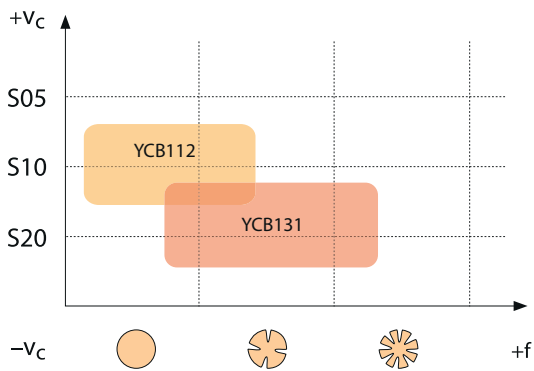

Carbide grades for non-ferrous metals

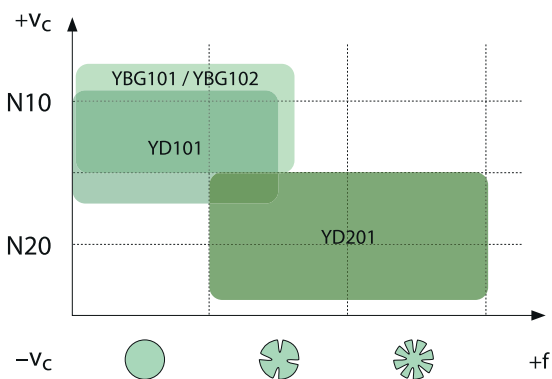

A

Turning

B

Milling

C

Drilling

D

Technical
Information

E

Index

A

Turning

PCD grades for non-ferrous metals

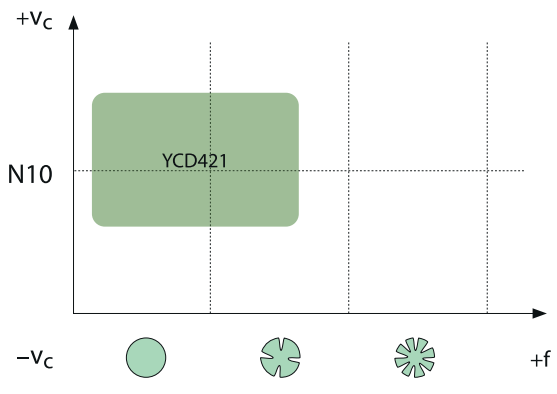

B

Milling

CBN grades for hardened steel

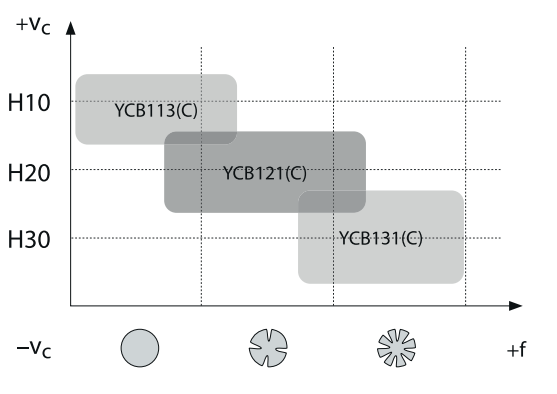

C

Drilling

D

Technical Information

Ceramic grades for hardened steel

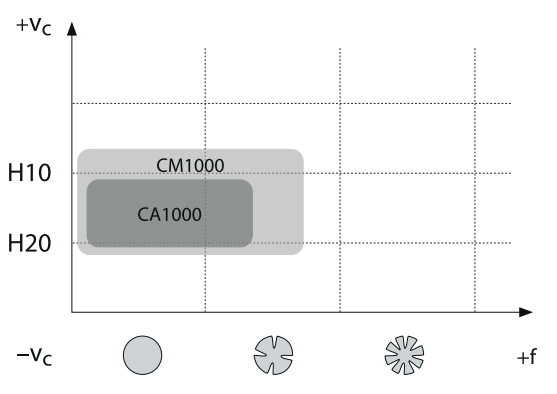

E

Index

Application fields of grades – general turning

	ISO	HC ¹ (CVD)	HC ¹ (PVD)	HT	HC ²	Ceramic	HW	CBN	PCD
P	P01	YBC103		YNG151	YNG151C				
	P10	YB6315		YNT251					
	P20	YBC152							
	P30	YBC203							
	P40	YBC252							
		YBC352							
M	M01		YBG105	YNG151	YNG151C				
	M10	YBM153	YB9320						
	M20	YBM253	YBG205						
	M30								
	M40								
K	K01					CN1000		YCB215	YZB223
	K10	YBD102	YBD152				YD201		
	K20	YB7315	YBD152C						
	K30								
N	N01								
	N10		YBG101	YBG102			YD101		YCD421
	N20						YD201		
	N30								
S	S01		YBS103			C51000		YCB112	
	S10		YBG102			CW1400		YCB131	
	S20		YBG105	YB9320	YPD201	CW1800			
	S30								
H	H01							YCB113(C)	
	H10							YCB121(C)	
	H20								YCB131(C)
	H30								

P	Steel
M	Stainless steel
K	Cast iron

N	Non-ferrous metals
S	Heat-resistant alloys
H	Hardened materials

HC¹ Coated carbide
 HT Uncoated cermet
 HC² Coated cermet
 HW Uncoated carbide

A

Turning

B

Milling

C

Drilling

D

Technical Information

E

Index

ISO standard

T N M G 22 04 08 (N) – DM

1 2 3 4 5 6 7 8 9

Insert shape		
A	B	C
D	E	H
K	L	M
O	P	R
S	T	V
W	Z Special	

Clearance angle	
A	B
C	D
E	F
G	N
P	O Special

Tolerance class			
Code	I.C [mm]	m [mm]	S [mm]
A	±0,025	±0,005	±0,025
C	±0,025	±0,013	±0,025
E	±0,025	±0,025	±0,025
F	±0,013	±0,005	±0,025
G	±0,025	±0,025	±0,130
H	±0,013	±0,013	±0,025
J	±0,05–0,15	±0,005	±0,025
K	±0,05–0,15	±0,013	±0,025
L	±0,05–0,15	±0,025	±0,025
M	±0,05–0,15	±0,08–0,20	±0,130
N	±0,05–0,15	±0,08–0,20	±0,025
U	±0,08–0,25	±0,13–0,38	±0,130

1

2

3

Fastening features (metric)	
Insert shape	
A	B
C	F
G	H
J	M
N	Q
R	T
U	W
X Special	

Cutting edge length l [mm]								
I.C [mm]	Insert shape							
	C	D	R	S	T	V	W	K
3,97	06							
5,0	05							
5,56	09							
6,0	06							
6,35	06	07			11	11		
8,0	08							
9,525	09	11	09	09	16	16	06	16
10,0	10							
12,0	12							
12,7	12	15	12	12	22	22	08	
15,875	16		15	15	27			
16,0	19							
19,05	19		19	19	33			
20,0	20							
25,0	25	25	25					
25,4	25 25							
31,75	31							
32	32							

4

5

Insert thickness S [mm]			
Code	S	Code	S
00	0,79	T5	5,95
T0	0,99	06	6,35
01	1,59	T6	6,75
T1	1,98	07	7,94
02	2,38	09	9,52
T2	2,58	T9	9,72
03	3,18	11	11,11
T3	3,97	12	12,70
04	4,76		
T4	4,96		
05	5,56		

6

Nose radius r [mm]	
Code	r
00	–
02	0,2
04	0,4
08	0,8
12	1,2
16	1,6
20	2,0
24	2,4
32	3,2
X	Special
MO	Round inserts

7

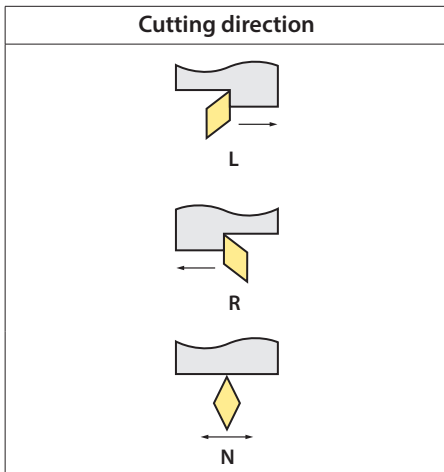

8

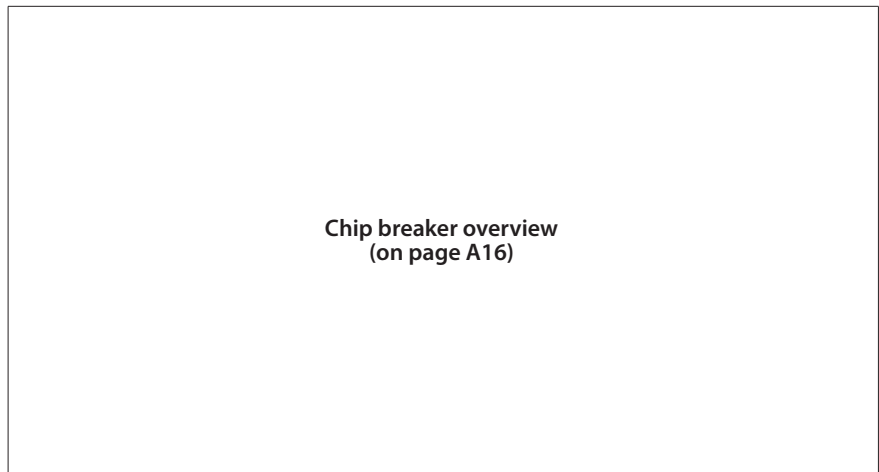

9

ANSI standard

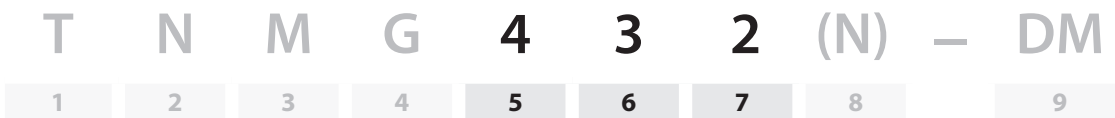

Inner circle		
Code	[mm]	Pouce
2	6.35	0.250
3	9.525	0.375
4	12.7	0.500
5	15.875	0.625
6	19.05	0.750
8	25.4	1.000

5

Insert thickness		
Code	[mm]	Pouce
2	3.18	0.125
3	4.76	0.187
4	6.35	0.250
5	7.94	0.313
6	9.52	0.375



6

Nose radius		
Code	[mm]	Pouce
0	0.2	0.008
1	0.4	0.016
2	0.8	0.031
3	1.2	0.047
4	1.6	0.063
5	2.0	0.079
6	2.4	0.094



7

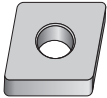
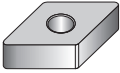
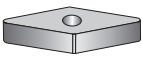

Conversion table for general turning inserts (metric/imperial system)



Negative angle/insert

	ISO	Inch
Insert shape C 	090304	321
	090308	322
	120404	431
	120408	432
	120412	433
	120416	434
	160608	542
	160612	543
	160616	544
	190608	642
	190612	643
	190616	644
	190624	646
	250724	856
	250732	858
	250924	866
250932	868	
Insert shape D 	110404	331
	110408	332
	110412	333
	150404	431
	150408	432
	150412	433
	150604	441
	150608	442
	150612	443
	190608	542
190612	543	
Insert shape V 	160404	331
	160408	332
	160412	333
Insert shape R 	0903MO	32
	1204MO	43

Positive angle/insert

	ISO	Inch
Insert shape W 	06T304	3(2.5)1
	06T308	3(2.5)2
	06T312	3(2.5)3
	060404	331
	060408	332
	060412	333
	080404	431
	080408	432
	080412	433
	Insert shape T 	113304
110308		222
160404		331
160408		332
160412		333
220404		431
220408		432
220412		433
220416		434
270608		542
270612	543	
270616	544	
Insert shape S 	090304	321
	090308	322
	090312	323
	120404	431
	120408	432
	120412	433
	120416	434
	150608	542
	150612	543
	150616	544
	190412	633
	190424	636
	190612	643
	190616	644
	250724	856
	250732	858
250924	866	
250932	868	

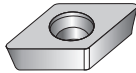
	ISO	Inch
Insert shape C 	060202	2(1.5)0
	060204	2(1.5)1
	060208	2(1.5)2
	09T302	3(2.5)0
	09T304	3(2.5)1
	09T308	3(2.5)2
	120404	431
	120408	432
	120412	433
	Inserts shape T 	06T102
06T104		1.2(1.2)1
06T108		1.2(1.2)2
090202		1.8(1.5)0
090204		1.8(1.5)1
090208		1.8(1.5)2
110202		2(1.5)0
110204		2(1.5)1
110208		2(1.5)2
110302		220
110304		221
110308		222
16T302		30
16T304		31
16T308		32
16T312		33
160400	330	
220408	432	
220412	433	
220416	434	
270408	532	
270412	533	
330612	643	
330616	644	

	ISO	Inch
Insert shape D 	070202	2(1.5)0
	070204	2(1.5)1
	070208	2(1.5)2
	11T302	3(2.5)0
	11T304	3(2.5)1
	11T308	3(2.5)2
	11T312	3(2.5)3
Insert shape S 	060204	2(1.5)1
	09T302	3(2.5)0
	09T304	3(2.5)1
	09T308	3(2.5)2
	120404	431
	120408	432
	120412	433
	150404	531
150408	532	
150412	533	
190408	632	
190412	633	
190416	634	
Inserts shape V 	110202	2(1.5)0
	110204	2(1.5)1
	110208	2(1.5)2
	110302	220
	110304	221
	110308	222
	160402	330
	160404	331
160408	332	
160412	333	

A

Turning

B

Milling

C

Drilling

D

Technical Information

E

Index

- Ideal machining conditions
- Normal machining conditions
- Unfavourable machining conditions

CNMG	L	I.C	S	d
09 03	9.7	9.525	3.18	3.81
12 04	12.9	12.7	4.76	5.16

Turning inserts

CN** negative insert				HC ¹ (CVD)								HC ¹ (PVD)			HT	HC ²	HW											
ISO	r	a _p	f	YBC103	YB6315	YBC152	YBC203	YBC252	YBC352	YBM153	YBM253	YBD102	YB7315	YBD152	YBD152C	YBG101	YBG102	YBG105	YBG205	YB9320	YPD201	YBS103	YNG151	YNT251	YNG151C	YD101	YD201	
				WG	CNMG120404-WG	0.4	0.25-3.00	0.05-0.25	○																			
Wiper	CNMG120408-WG	0.8	0.5-5.0	0.15-0.70	●	●						○																
	CNMG120412-WG	1.2	0.8-6.0	0.20-0.75	●																							
ADF	CNMG120404-ADF	0.4	0.5-3.0	0.05-0.30	●													●	●									
Finishing	CNMG120408-ADF	0.8	0.5-3.0	0.1-0.4	●													○	●					●				
	CNMG120412-ADF	1.2	0.8-3.0	0.15-0.50	○															●				●				
DF	CNMG090304-DF	0.4	0.25-1.50	0.07-0.30	●	●																						
Finishing	CNMG090308-DF	0.8	0.3-1.5	0.1-0.3	●	○																						
	CNMG120404-DF	0.4	0.25-1.50	0.07-0.30	●	●																						
	CNMG120408-DF	0.8	0.3-1.5	0.1-0.4	●	●																						
	CNMG120412-DF	1.2	0.35-1.50	0.10-0.35	●	●																						
EF	CNMG090304-EF	0.4	0.5-2.0	0.05-0.20						○								●										
Finishing	CNMG090308-EF	0.8	0.5-2.0	0.05-0.25						○								●										
	CNMG120404-EF	0.4	0.5-2.5	0.05-0.20						●								●										
	CNMG120408-EF	0.8	0.5-2.5	0.05-0.25						●								●										
	CNMG120412-EF	1.2	0.5-2.5	0.10-0.35						○								○										
SF	CNMG090304-SF	0.4	0.05-0.50	0.05-0.30																				●				
Finishing	CNMG120404-SF	0.4	0.1-1.5	0.05-0.30																				●				
	CNMG120408-SF	0.8	0.1-1.5	0.10-0.35																				●				

● Ex stock ○ On demand
 YBC152F, YBC252F, YBM153F, YBM253F available

HC¹ Coated carbide
 HT Uncoated cermet
 HC² Coated cermet
 HW Uncoated carbide

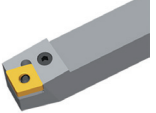
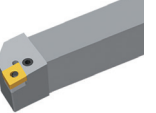
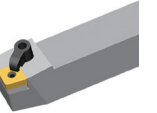
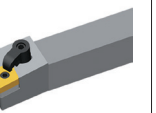
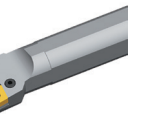
Tool holder					
DCLNR/L	PCBNR/L	PCLNR/L	MCBNR/L	MCLNR/L	A***-PCLNR/L
Kr: 95°	Kr: 75°	Kr: 95°	Kr: 75°	Kr: 95°	Kr: 95°
					
A230	A237	A238	A252	A253	A324

System code > A48 Grade selection > A42 Technical info > A501 Cutting data > A366



A

Turning

B

Milling

C

Drilling

D

Technical Information

E

Index

A

Turning

- Ideal machining conditions
- ⊗ Normal machining conditions
- ⊗ Unfavourable machining conditions

CN**	L	I.C	S	d
12 04	12.9	12.7	4.76	5.16

Turning inserts

CN** negative insert					HC ¹ (CVD)								HC ¹ (PVD)		HT	HC ²	HW															
					P	●●●●	⊗⊗	⊗							●	⊗	●															
					M			●	⊗					●	⊗	●	⊗	●														
					K																											
					N											●	●				●	⊗										
					S											●	⊗	●			●	⊗										
					H																											
	ISO	r	a _p	f	YBC103	YB6315	YBC152	YBC203	YBC252	YBC352	YBM153	YBM253	YBD102	YB7315	YBD152	YBD152C	YBG101	YBG102	YBG105	YBG205	YB9320	YPD201	YBS103	YNG151	YNT251	YNG151C	YD101	YD201				
NF 	CNEG120404-NF	0.4	0.2-2.5	0.05-0.30													○	●														
	CNEG120408-NF	0.8	0.2-2.5	0.10-0.35														○	●													
	CNEG120412-NF	1.2	0.2-2.5	0.13-0.40														○	●													
XF 	CNMG120404-XF	0.4	0.5-2.5	0.1-0.25	●			●																								
	CNMG120408-XF	0.8	0.5-2.5	0.1-0.30	●			●																								
	CNMG120412-XF	1.2	0.5-2.5	0.1-0.35	●			●																								

● Ex stock ○ On demand

HC¹ Coated carbide
 HT Uncoated cermet
 HC² Coated cermet
 HW Uncoated carbide

B

Milling

C

Drilling

D

Technical Information

E

Index



Tool holder					
DCLNR/L	PCBNR/L	PCLNR/L	MCBNR/L	MCLNR/L	S***-PCLNR/L
Kr: 95°	Kr: 75°	Kr: 95°	Kr: 75°	Kr: 95°	Kr: 95°
A230	A237	A238	A252	A253	A324



CNMG	L	I.C	S	d
09 03	9.7	9.525	3.18	3.81
12 04	12.9	12.7	4.76	5.16
16 06	16.1	15.875	6.35	6.35
19 06	19.3	19.05	6.35	7.94

- Ideal machining conditions
- Normal machining conditions
- Unfavourable machining conditions

Turning inserts

CN** negative insert				HC ¹ (CVD)								HC ¹ (PVD)			HT	HC ²	HW			
ISO	r	a _p	f	P	M	K	N	S	H											
PM  Medium Cut	CNMG090304-PM	0.4	0.4-4.0	0.1-0.3	●	●	●	●	●	●	●	●	●	●	●	●				
	CNMG090308-PM	0.8	0.5-4.0	0.15-0.50							●	●	●	●	●	●				
	CNMG120404-PM	0.4	0.4-5.5	0.1-0.3		●	●													
	CNMG120408-PM	0.8	0.5-5.5	0.15-0.50		●	●	●												
	CNMG120412-PM	1.2	0.8-5.5	0.18-0.60		●	●													
	CNMG120416-PM	1.6	1.0-5.5	0.23-0.65		●	●													
	CNMG160608-PM	0.8	0.5-7.2	0.15-0.50		○	●					○	○							
	CNMG160612-PM	1.2	0.8-7.2	0.18-0.60		●	●					●	●							
	CNMG160616-PM	1.6	1.0-7.2	0.23-0.65			●					●	○							
	CNMG190608-PM	0.8	0.5-8.6	0.15-0.50			●													
	CNMG190612-PM	1.2	0.8-8.6	0.18-0.60			●					○	●							
	CNMG190616-PM	1.6	1.0-8.6	0.23-0.65			○						○							
XM  Medium Cut	CNMG120404-XM	0.4	1-4.2	0.2-0.3	●		○													
	CNMG120408-XM	0.8	1-4.2	0.2-0.4	●		●													
	CNMG120412-XM	1.2	1-4.2	0.2-0.6	●		●													
	CNMG120416-XM	1.6	1-4.2	0.2-0.65	●		●													
	CNMG160608-XM	0.8	1-5.6	0.2-0.4	●		●													
	CNMG160612-XM	1.2	1-5.6	0.2-0.6	●		●													
	CNMG160616-XM	1.6	1-5.6	0.2-0.65	○		●													
	CNMG190608-XM	0.8	1-6.65	0.2-0.4	●		●													
CNMG190612-XM	1.2	1-6.65	0.2-0.6	○		●														
CNMG190616-XM	1.6	1-6.65	0.2-0.65	○		●														

● Ex stock ○ On demand
 YBC152F, YBC252F, YBM153F, YBM253F available

HC¹ Coated carbide
 HT Uncoated cermet
 HC² Coated cermet
 HW Uncoated carbide

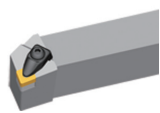
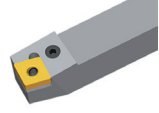
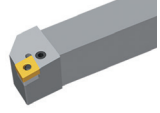
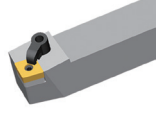
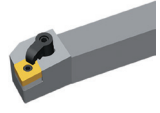
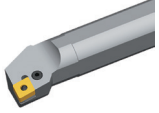
Tool holder					
DCLNR/L	PCBNR/L	PCLNR/L	MCBNR/L	MCLNR/L	A***-PCLNR/L
Kr: 95°	Kr: 75°	Kr: 95°	Kr: 75°	Kr: 95°	Kr: 95°
					
A230	A237	A238	A252	A253	A324

System code > A48 Grade selection > A42 Technical info > A501 Cutting data > A366



A Turning
 B Milling
 C Drilling
 D Technical Information
 E Index

A

Turning

B

Milling

C

Drilling

D

Technical Information

E

Index

CNMG	L	I.C	S	d
09 03	9.7	9.525	3.18	3.81
12 04	12.9	12.7	4.76	5.16
16 06	16.1	15.875	6.35	6.35
19 06	19.3	19.05	6.35	7.94

- Ideal machining conditions
- ● Normal machining conditions
- ● ● Unfavourable machining conditions

Turning inserts

CN** negative insert				HC ¹ (CVD)										HC ¹ (PVD)		HT	HC ²	HW											
	P	M	K	N	S	H																							
	ISO	r	a _p	f	YBC103	YB6315	YBC152	YBC203	YBC252	YBC352	YBM153	YBM253	YBD102	YB7315	YBD152	YBD152C	YBG101	YBG102	YBG105	YBG205	YB9320	YPD201	YBS103	YNG151	YNT251	YNG151C	YD101	YD201	
	DM Medium Cut	CNMG090304-DM	0.4	0.4-4.0	0.1-0.3	●	●																						
		CNMG090308-DM	0.8	0.5-4.0	0.15-0.50	●	●																						
		CNMG090312-DM	1.2	0.5-3.0	0.1-0.4				○																				
		CNMG120404-DM	0.4	0.4-5.5	0.1-0.3	●	●																						
CNMG120408-DM		0.8	0.5-5.5	0.15-0.50	○	●	●	○	●																				
CNMG120412-DM		1.2	0.8-5.5	0.18-0.60	○	●	●		○																				
CNMG120416-DM		1.6	1.0-5.5	0.23-0.65	○	●																							
CNMG160608-DM		0.8	0.5-7.2	0.15-0.50	○	●																							
CNMG160612-DM		1.2	0.8-7.2	0.18-0.60	●	●																							
CNMG160616-DM		1.6	1.0-7.2	0.23-0.65	●	●																							
CNMG190608-DM		0.8	0.5-8.6	0.15-0.50	●	●																							
CNMG190612-DM		1.2	0.8-8.6	0.18-0.60	●	●																							
CNMG190616-DM		1.6	1.0-8.6	0.23-0.65		●																							
EG Medium Cut		CNMG120404-EG	0.4	0.5-4.0	0.05-0.30						●	●								○	●								
	CNMG120408-EG	0.8	0.5-4.0	0.1-0.4						●	●									●	●								
	CNMG120412-EG	1.2	0.5-4.0	0.2-0.5							●									●	●								
EM Medium Cut	CNMG120404-EM	0.4	0.5-4.0	0.05-0.30						●	●								●										
	CNMG120408-EM	0.8	0.5-5.7	0.15-0.45						●	●									●									
	CNMG120412-EM	1.2	0.5-5.7	0.25-0.60						●	●									●									
	CNMG160608-EM	0.8	0.5-7.2	0.15-0.45						●	●									●									
	CNMG160612-EM	1.2	0.5-7.2	0.25-0.60						●	●									●									

● Ex stock ○ On demand
 YBC152F, YBC252F, YBM153F, YBM253F available

HC¹ Coated carbide
 HT Uncoated cermet
 HC² Coated cermet
 HW Uncoated carbide

Tool holder					
DCLNR/L	PCBNR/L	PCLNR/L	MCBNR/L	MCLNR/L	A***-PCLNR/L
Kr: 95°	Kr: 75°	Kr: 95°	Kr: 75°	Kr: 95°	Kr: 95°
A230	A237	A238	A252	A253	A324

System code > A48 Grade selection > A42 Technical info > A501 Cutting data > A366



- Ideal machining conditions
- ⊗ Normal machining conditions
- ⊗ Unfavourable machining conditions

CNMG	L	I.C	S	d
12 04	12.9	12.7	4.76	5.16

Turning inserts

CN** negative insert				HC ¹ (CVD)								HC ¹ (PVD)			HT	HC ²	HW										
				P	●	●	●	●	⊗	⊗					●	⊗	●										
				M					●	⊗			●	●	⊗	⊗	●	⊗	●								
				K								⊗	⊗	⊗	⊗												
				N									●	●					●	⊗							
				S										●	●	⊗	⊗	●		●	⊗						
				H																							
ISO	r	a _p	f	YBC103	YB6315	YBC152	YBC203	YBC252	YBC352	YBM153	YBM253	YBD102	YB7315	YBD152	YBD152C	YBG101	YBG102	YBG105	YBG205	YB9320	YPD201	YBS103	YNG151	YNT251	YNG151C	YD101	YD201
ZM	CNMG120404-ZM	0.4	0.5-3.0	0.05-0.30	●																						
	CNMG120408-ZM	0.8	0.5-4.0	0.1-0.5	○																						
Medium Cut																											

● Ex stock ○ On demand

HC¹ Coated carbide
 HT Uncoated cermet
 HC² Coated cermet
 HW Uncoated carbide

Tool holder					
DCLNR/L	PCBNR/L	PCLNR/L	MCBNR/L	MCLNR/L	S***-PCLNR/L
Kr: 95°	Kr: 75°	Kr: 95°	Kr: 75°	Kr: 95°	Kr: 95°
A230	A237	A238	A252	A253	A324

System code > A48

Grade selection > A42

Technical info > A501

Cutting data > A366



A

Turning

B

Milling

C

Drilling

D

Technical Information

E

Index

General turning Negative inserts

A

Turning

- Ideal machining conditions
- ⊗ Normal machining conditions
- ⊘ Unfavourable machining conditions

CNMG	L	I.C	S	d
12 04	12.9	12.7	4.76	5.16
16 06	16.1	15.875	6.35	6.35

Turning inserts

CN** negative insert	HC ¹ (CVD)							HC ¹ (PVD)		HT	HC ²	HW
	P	M	K	N	S	H						
	●	●	●	●	●	●				●		
		●	●	●	●	●	●	●	●	●	●	
		●						●	●			
			●	●	●	●						
							●	●				●
								●	●			●

B

Milling

	ISO	r	a _p	f	Machining Conditions																						
					YBC103	YB6315	YBC152	YBC203	YBC252	YBC352	YBM153	YBM253	YBD102	YB7315	YBD152	YBD152C	YBG101	YBG102	YBG105	YBG205	YB9320	YPD201	YBS103	YNG151	YNT251	YNG151C	YD101
 Medium Cut	CNMG120404-NM	0.4	0.2-3.0	0.05-0.30																							
	CNMG120408-NM	0.8	0.2-4.0	0.1-0.5																							
	CNMG120412-NM	1.2	0.2-4.0	0.2-0.6																							
 Medium Cut	CNMG120404-TC	0.4	0.5-5.0	0.08-0.40									●	●													
	CNMG120408-TC	0.8	0.5-5.0	0.15-0.50									●	●													
	CNMG120412-TC	1.2	0.5-5.0	0.2-0.6									●	●													
	CNMG120416-TC	1.6	0.5-5.0	0.20-0.65									●	○													
	CNMG160608-TC	0.8	1-7	0.15-0.50									●	●													
	CNMG160612-TC	1.2	1-7	0.2-0.6									●	●													
 Medium Cut	CNMG120408-TK	0.8	0.2-0.4	0.2-0.4									○														
	CNMG120412-TK	1.2	0.2-0.4	0.2-0.45									○														
	CNMG120416-TK	1.6	0.2-0.4	0.2-0.5									●														

● Ex stock ○ On demand

HC¹ Coated carbide
HT Uncoated cermet
HC² Coated cermet
HW Uncoated carbide

D

Technical Information

Tool holder					
DCLNR/L	PCBNR/L	PCLNR/L	MCBNR/L	MCLNR/L	S***-PCLNR/L
Kr: 95°	Kr: 75°	Kr: 95°	Kr: 75°	Kr: 95°	Kr: 95°
A230	A237	A238	A252	A253	A324

E

Index

System code > A48

Grade selection > A42



Technical info > A501

Cutting data > A366

CNMG	L	I.C	S	d
12 04	12.9	12.7	4.76	5.16
16 06	16.1	15.875	6.35	6.35
19 06	19.3	19.05	6.35	7.94
25 09	25.79	25.4	9.525	9.12

- Ideal machining conditions
- Normal machining conditions
- Unfavourable machining conditions

Turning inserts

CN** negative insert				HC ¹ (CVD)								HC ¹ (PVD)		HT	HC ²	HW										
ISO	r	a _p	f																							
				YBC103	YBC152	YBC203	YBC252	YBC352	YBM153	YBM253	YBD102	YBD152	YBD152C	YBG101	YBG102	YBG105	YBG205	YB9320	YPD201	YBS103	YNG151	YNT251	YNG151C	YD101	YD201	
DR  Roughing	CNMG120408-DR	0.8	0.7-7.0	0.2-0.5	○ ●	● ●	● ●	● ●	● ●	● ●	● ●	● ●	● ●	● ●	● ●	● ●	● ●	● ●	● ●	● ●	● ●	● ●	● ●	● ●	● ●	● ●
	CNMG120412-DR	1.2	1-7	0.25-0.70	○ ●	● ●	● ●	● ●	● ●	● ●	● ●	● ●	● ●	● ●	● ●	● ●	● ●	● ●	● ●	● ●	● ●	● ●	● ●	● ●	● ●	● ●
	CNMG120416-DR	1.6	1.5-7.0	0.32-0.75	○ ●	● ●	● ●	● ●	● ●	● ●	● ●	● ●	● ●	● ●	● ●	● ●	● ●	● ●	● ●	● ●	● ●	● ●	● ●	● ●	● ●	● ●
	CNMG160608-DR	0.8	0.7-8.0	0.2-0.5	○ ●	● ●	● ●	● ●	● ●	● ●	● ●	● ●	● ●	● ●	● ●	● ●	● ●	● ●	● ●	● ●	● ●	● ●	● ●	● ●	● ●	● ●
	CNMG160612-DR	1.2	1-8	0.25-0.70	○ ●	● ●	● ●	● ●	● ●	● ●	● ●	● ●	● ●	● ●	● ●	● ●	● ●	● ●	● ●	● ●	● ●	● ●	● ●	● ●	● ●	● ●
	CNMG160616-DR	1.6	1.5-8.0	0.3-0.8	○ ●	● ●	● ●	● ●	● ●	● ●	● ●	● ●	● ●	● ●	● ●	● ●	● ●	● ●	● ●	● ●	● ●	● ●	● ●	● ●	● ●	● ●
	CNMG190608-DR	0.8	0.7-10.0	0.2-0.5	○ ●	● ●	● ●	● ●	● ●	● ●	● ●	● ●	● ●	● ●	● ●	● ●	● ●	● ●	● ●	● ●	● ●	● ●	● ●	● ●	● ●	● ●
	CNMG190612-DR	1.2	1-10	0.25-0.70	○ ●	● ●	● ●	● ●	● ●	● ●	● ●	● ●	● ●	● ●	● ●	● ●	● ●	● ●	● ●	● ●	● ●	● ●	● ●	● ●	● ●	● ●
	CNMG190616-DR	1.6	1.5-10.0	0.3-0.8	○ ●	● ●	● ●	● ●	● ●	● ●	● ●	● ●	● ●	● ●	● ●	● ●	● ●	● ●	● ●	● ●	● ●	● ●	● ●	● ●	● ●	● ●
	CNMG190624-DR	2.4	2-10	0.32-0.90	○ ●	● ●	● ●	● ●	● ●	● ●	● ●	● ●	● ●	● ●	● ●	● ●	● ●	● ●	● ●	● ●	● ●	● ●	● ●	● ●	● ●	● ●
CNMG250924-DR	2.4	2-15	0.4-1.0	○ ●	● ●	● ●	● ●	● ●	● ●	● ●	● ●	● ●	● ●	● ●	● ●	● ●	● ●	● ●	● ●	● ●	● ●	● ●	● ●	● ●	● ●	
SNR  Roughing	CNMG120408-SNR	0.8	1-3	0.1-0.4	○ ●	● ●	● ●	● ●	● ●	● ●	● ●	● ●	● ●	● ●	● ●	● ●	● ●	● ●	● ●	● ●	● ●	● ●	● ●	● ●	● ●	
	CNMG120412-SNR	1.2	1-3	0.2-0.6	○ ●	● ●	● ●	● ●	● ●	● ●	● ●	● ●	● ●	● ●	● ●	● ●	● ●	● ●	● ●	● ●	● ●	● ●	● ●	● ●	● ●	
	CNMG160608-SNR	0.8	2-6	0.1-0.4	○ ●	● ●	● ●	● ●	● ●	● ●	● ●	● ●	● ●	● ●	● ●	● ●	● ●	● ●	● ●	● ●	● ●	● ●	● ●	● ●	● ●	
	CNMG190616-SNR	1.6	2-7	0.2-0.6	○ ●	● ●	● ●	● ●	● ●	● ●	● ●	● ●	● ●	● ●	● ●	● ●	● ●	● ●	● ●	● ●	● ●	● ●	● ●	● ●	● ●	

● Ex stock ○ On demand
 YBC152F, YBC252F, YBM153F, YBM253F available

HC¹ Coated carbide
 HT Uncoated cermet
 HC² Coated cermet
 HW Uncoated carbide

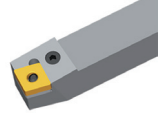
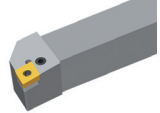
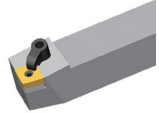
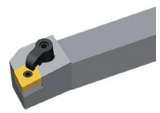
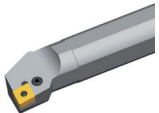
Tool holder					
DCLNR/L	PCBNR/L	PCLNR/L	MCBNR/L	MCLNR/L	S***-PCLNR/L
Kr: 95°	Kr: 75°	Kr: 95°	Kr: 75°	Kr: 95°	Kr: 95°
					
A230	A237	A238	A252	A253	A324

A

Turning

B

Milling

C

Drilling

D

Technical Information

E

Index

CN**	L	I.C	S	d
12 04	12.9	12.7	4.76	5.16
16 06	16.1	15.875	6.35	6.35
19 06	19.3	19.05	6.35	7.94
25 07	25.79	25.4	7.94	9.12
25 09	25.79	25.4	9.525	9.12

- Ideal machining conditions
- ⊗ Normal machining conditions
- ⊗ Unfavourable machining conditions

Turning inserts

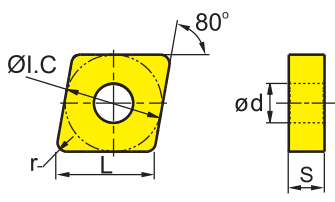

CN** negative insert				HC ¹ (CVD)										HC ¹ (PVD)		HT	HC ²	HW											
				P	M	K	N	S	H																				
				YBC103	YB6315	YBC152	YBC203	YBC252	YBC352	YBM153	YBM253	YBD102	YB7315	YBD152	YBD152C	YBG101	YBG102	YBG105	YBG205	YB9320	YPD201	YBS103	YNG151	YNT251	YNG151C	YD101	YD201		
ISO	r	a _p	f																										
DR Roughing	CNMM120412-DR	1.2	1.0-7.5	0.25-0.70	○	●	●	●	○	○																			
	CNMM160612-DR	1.2	1.0-9.5	0.25-0.70		●	●																						
	CNMM160616-DR	1.6	1.5-9.5	0.32-0.90		●	●	○																					
	CNMM190612-DR	1.2	1-12	0.25-0.70	○	●	●	●	●																				
	CNMM190616-DR	1.6	1.5-12.0	0.32-0.90		●	●	●																					
	CNMM190624-DR	2.4	2-12	0.35-1.20	○	●	●																						
CNMM250924-DR	2.4	2.0-12.5	0.2-1.2		●	●	○																						
ER Roughing	CNMG120408-ER	0.8	2.0-7.6	0.15-0.55							○																		
	CNMG120412-ER	1.2	2.0-7.6	0.25-0.80							○																		
	CNMG160612-ER	1.2	2-10	0.35-0.80							○																		
	CNMG160616-ER	1.6	2-10	0.45-1.00							○																		
	CNMG190612-ER	1.2	2.0-11.4	0.35-1.00			○				○								○										
CNMG190616-ER	1.6	2.0-11.4	0.45-1.10							○																			
ER Roughing	CNMM250724-ER	2.4	2.0-12.5	0.3-1.4				●																					
	CNMM250732-ER	3.2	2.0-12.5	0.45-1.80				○																					
	CNMM250924-ER	2.4	2.0-12.5	0.3-1.4				●			○																		
	CNMM250932-ER	3.2	2.0-12.5	0.45-1.80				●																					

● Ex stock ○ On demand
YBC152F, YBC252F, YBM153F, YBM253F available

HC¹ Coated carbide
HT Uncoated cermet
HC² Coated cermet
HW Uncoated carbide

Tool holder					
DCLNR/L	PCBNR/L	PCLNR/L	MCBNR/L	MCLNR/L	S***-PCLNR/L
Kr: 95°	Kr: 75°	Kr: 95°	Kr: 75°	Kr: 95°	Kr: 95°
A230	A237	A238	A252	A253	A324



CNMM	L	I.C	S	d
12 04	12.9	12.7	4.76	5.16
16 06	16.1	15.875	6.35	6.35
19 06	19.3	19.05	6.35	7.94
25 09	25.79	25.4	9.525	9.12

- Ideal machining conditions
- Normal machining conditions
- Unfavourable machining conditions

Turning inserts

CN** negative insert				HC ¹ (CVD)								HC ¹ (PVD)		HT	HC ²	HW												
ISO	r	a _p	f	YBC103	YB6315	YBC152	YBC203	YBC252	YBC352	YBM153	YBM253	YBD102	YB7315	YBD152	YBD152C	YBG101	YBG102	YBG105	YBG205	YB9320	YPD201	YBS103	YNG151	YNT251	YNG151C	YD101	YD201	
				LR	CNMM120408-LR	0.8	1-5	0.1-0.5	●	●																		
	CNMM120412-LR	1.2	2-6	0.2-0.7	●	●				○																		
	CNMM120416-LR	1.6	2.0-6.5	0.25-0.80		●																						
	CNMM160608-LR	0.8	1-7	0.2-0.6	●	●				○																		
	CNMM160612-LR	1.2	1.0-7.5	0.2-0.7	●	●				●																		
	CNMM160616-LR	1.6	1.0-8.5	0.25-0.80	○	●	○	●																				
	CNMM190612-LR	1.2	2.0-10.5	0.2-0.7	●	●																						
	CNMM190616-LR	1.6	2.0-10.5	0.3-1.0	●	●				●																		
	CNMM190624-LR	2.4	2.0-10.5	0.3-1.1	●	○																						
	CNMM250924-LR	2.4	2.0-12.5	0.3-1.2	○	●																						

● Ex stock ○ On demand
 YBC152F, YBC252F, YBM153F, YBM253F available

HC¹ Coated carbide
 HT Uncoated cermet
 HC² Coated cermet
 HW Uncoated carbide

Tool holder					
DCLNR/L	PCBNR/L	PCLNR/L	MCBNR/L	MCLNR/L	S***-PCLNR/L
Kr: 95°	Kr: 75°	Kr: 95°	Kr: 75°	Kr: 95°	Kr: 95°
A230	A237	A238	A252	A253	A324

A
Turning
B
Milling
C
Drilling
D
Technical Information
E
Index

A

Turning

B

Milling

C

Drilling

D

Technical Information

E

Index

CNMM	L	I.C	S	d
12 04	12.9	12.7	4.76	5.16
16 06	16.1	15.875	6.35	6.35
19 06	19.3	19.05	6.35	7.94
25 09	25.79	25.4	9.525	9.12

- Ideal machining conditions
- ⊗ Normal machining conditions
- ⊙ Unfavourable machining conditions

Turning inserts

CN** negative insert					HC ¹ (CVD)								HC ¹ (PVD)		HT	HC ²	HW											
					P	M	K	N	S	H																		
	ISO	r	a _p	f	YBC103	YB6315	YBC152	YBC203	YBC252	YBC352	YBM153	YBM253	YBD102	YB7315	YBD152	YBD152C	YBG101	YBG102	YBG105	YBG205	YB9320	YPD201	YBS103	YNG151	YNT251	YNG151C	YD101	YD201
Basic	CNMM120404	0.4	0.5-7.0	0.1-0.5																								
	CNMM190612	1.2	0.5-10.5	0.1-0.8																								
	CNMM190616	1.6	0.5-10.5	0.1-1.0																								
Medium Cut																												
HDR	CNMM120408-HDR	0.8	1-7	0.2-0.6				●	●																			
	CNMM120412-HDR	1.2	1-7	0.3-0.8				○	●																			
	CNMM120416-HDR	1.6	1-7	0.4-1.0				●	●																			
	CNMM160612-HDR	1.2	1.5-7.5	0.3-0.8				●	●																			
	CNMM160616-HDR	1.6	1.5-8.5	0.4-1.0				○	●																			
	CNMM160624-HDR	2.4	1.5-10.5	0.8-1.2				○	○																			
	CNMM190608-HDR	0.8	2.0-12.5	0.3-0.7				○																				
	CNMM190612-HDR	1.2	2.0-12.5	0.35-0.80				○	●																			
	CNMM190616-HDR	1.6	2.0-12.5	0.5-1.1				○	●	●						○												
	CNMM190624-HDR	2.4	2.0-12.5	0.8-1.2				●	●																			
CNMM250924-HDR	2.4	2.0-12.5	0.8-1.4				○	●																				
HPR	CNMM190616-HPR	1.6	2.0-10.5	0.5-1.0					○																			
	CNMM190624-HPR	2.4	2.0-10.5	0.7-1.4				●	○																			
	CNMM250924-HPR	2.4	2.0-12.5	0.7-1.4					●	●																		

● Ex stock ○ On demand
 YBC152F, YBC252F, YBM153F, YBM253F available

HC¹ Coated carbide
 HT Uncoated cermet
 HC² Coated cermet
 HW Uncoated carbide

Tool holder					
DCLNR/L	PCBNR/L	PCLNR/L	MCBNR/L	MCLNR/L	S***-PCLNR/L
Kr: 95°	Kr: 75°	Kr: 95°	Kr: 75°	Kr: 95°	Kr: 95°
A230	A237	A238	A252	A253	A324

System code > A48 Grade selection > A42 Technical info > A501 Cutting data > A366



CN**	L	I.C	S	d
12 04	12.9	12.7	4.76	5.16
16 06	16.1	15.875	6.35	6.35
19 06	19.3	19.05	6.35	7.94

- Ideal machining conditions
- Normal machining conditions
- Unfavourable machining conditions

Turning inserts

CN** negative insert				HC ¹ (CVD)								HC ¹ (PVD)			HT	HC ²	HW											
				P	M	K	N	S	H																			
ISO	r	a _p	f	YBC103	YB6315	YBC152	YBC203	YBC252	YBC352	YBM153	YBM253	YBD102	YB7315	YBD152	YBD152C	YBG101	YBG102	YBG105	YBG205	YB9320	YPD201	YBS103	YNG151	YNT251	YNG151C	YD101	YD201	
Flat 	CNMA120404	0.4	0.2-5.0	0.05-0.40								○																
	CNMA120408	0.8	0.2-5.0	0.05-0.50								●	●	●	●													
	CNMA120412	1.2	0.2-5.0	0.1-0.6								●	●	●	●												○	
	CNMA120416	1.6	0.2-5.0	0.10-0.65								●	●	○														
	CNMA160608	0.8	0.2-7.0	0.1-0.5								○																
	CNMA160612	1.2	0.2-7.0	0.1-0.6								●	●															
	CNMA160616	1.6	0.2-7.0	0.15-0.65								○	●															
	CNMA190612	1.2	0.2-8.0	0.15-0.70								○	●															
CNMA190616	1.6	0.2-8.0	0.15-0.70								●	●																
Basic 	CNMG120404	0.4	0.1-5.0	0.05-0.50				○																				
	CNMG120408	0.8	0.1-5.0	0.1-0.6				○						○														
	CNMG120412	1.2	0.1-5.0	0.1-0.7		○	○																					
	CNMG160612	1.2	0.1-7.0	0.1-0.7																								
	CNMG190608	0.8	0.1-8.0	0.1-0.7																								
	CNMG190612	1.2	0.1-8.0	0.1-0.8																								
CNMG190616	1.6	0.1-8.0	0.1-1.0																									

● Ex stock ○ On demand
 YBC152F, YBC252F, YBM153F, YBM253F available

HC¹ Coated carbide
 HT Uncoated cermet
 HC² Coated cermet
 HW Uncoated carbide

Tool holder					
DCLNR/L	PCBNR/L	PCLNR/L	MCBNR/L	MCLNR/L	S***-PCLNR/L
Kr: 95°	Kr: 75°	Kr: 95°	Kr: 75°	Kr: 95°	Kr: 95°
A230	A237	A238	A252	A253	A324

General turning Negative inserts

A

Turning

B

Milling

C

Drilling

D

Technical Information

E

Index

- Ideal machining conditions
- ⊗ Normal machining conditions
- ⊗ Unfavourable machining conditions

DN**	L	I.C	S	d
11 04	11.6	9.525	4.76	3.81
15 04	15.5	12.7	4.76	5.16
15 06	15.5	12.7	6.35	5.16

Turning inserts

DN** negative insert	HC ¹ (CVD)					HC ¹ (PVD)			HT	HC ²	HW
	P	M	K	N	S	H					
	●●●●●	●●●●●	●●●●●	●●●●●	●●●●●	●●●●●	●●●●●	●●●●●	●●●●●	●●●●●	

	ISO	r	a _p	f	YBC103	YB6315	YBC152	YBC203	YBC252	YBC352	YBM153	YBM253	YBD102	YB7315	YBD152	YBD152C	YBG101	YBG102	YBG105	YBG205	YB9320	YPD201	YBS103	YNG151	YNT251	YNG151C	YD101	YD201
					WG	DNMX110404-WG	0.4	0.2-1.5	0.08-0.30		○																	
	DNMX110408-WG	0.8	0.5-3.5	0.15-0.50		●	●																					
	DNMX150408-WG	0.8	0.5-5.0	0.15-0.70		○																						
	DNMX150608-WG	0.8	0.5-5.0	0.15-0.70		○	○																					
Wiper	DNMX150612-WG	1.2	0.8-6.0	0.20-0.75		○																						
ADF	DNMG150604-ADF	0.4	0.5-6.0	0.15-0.50	○															●				○				
	DNMG150608-ADF	0.8	0.1-4.0	0.08-0.50	○															●	●			○				
	DNMG150612-ADF	1.2	0.5-4.0	0.15-0.50	○																							
Finishing	DNMG110404-DF	0.4	0.15-2.00	0.08-0.25		●	●																					
	DNMG110408-DF	0.8	0.15-2.00	0.1-0.3		●	●																					
DF	DNMG110412-DF	1.2	0.35-1.50	0.15-0.50		○																						
	DNMG150404-DF	0.4	0.15-2.00	0.08-0.25		●	●																					
	DNMG150408-DF	0.8	0.15-2.00	0.1-0.3		●	●																					
	DNMG150412-DF	1.2	0.35-1.50	0.15-0.50			○																					
Finishing	DNMG150604-DF	0.4	0.8-6.0	0.18-0.60		●	●																					
	DNMG150608-DF	0.8	0.15-2.00	0.1-0.3		●	●																					
	DNMG150612-DF	1.2	0.2-2.5	0.10-0.35		●																						
SF	DNMG110404-SF	0.4	0.05-0.50	0.05-0.25																						●		
	DNMG150404-SF	0.4	0.05-0.50	0.05-0.25																						●		
	DNMG150408-SF	0.8	0.05-0.50	0.10-0.35																						●		
	DNMG150604-SF	0.4	0.05-0.50	0.05-0.25																						●		
Finishing	DNMG150608-SF	0.8	0.05-0.50	0.10-0.35																						●		

● Ex stock ○ On demand
 YBC152F, YBC252F, YBM153F, YBM253F available

HC¹ Coated carbide
 HT Uncoated cermet
 HC² Coated cermet
 HW Uncoated carbide

Tool holder						
DDJNR/L	PDJNR/L	PDNNR/L	MDJNR/L	MDPNN	S***-PDSNR/L	A***-PDUNR/L
Kr: 93°	Kr: 93°	Kr: 63°	Kr: 93°	Kr: 62°30'	Kr: 62°30'	Kr: 93°
A231	A240	A241	A254	A255	A326	A327

System code > A48 Grade selection > A42 Technical info > A501 Cutting data > A366



- Ideal machining conditions
- Normal machining conditions
- Unfavourable machining conditions

DNMG	L	I.C	S	d
11 04	11.6	9.525	4.76	3.81
15 06	15.5	12.7	6.35	5.16

Turning inserts

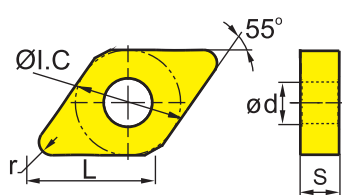

DN** negative insert				HC ¹ (CVD)								HC ¹ (PVD)				HT	HC ²	HW			
				P	M	K	N	S	H												
ISO				r	a _p	f															
XF 	DNMG110404-XF	0.4	0.5-2.0	0.1-0.25	●																
	DNMG110408-XF	0.8	0.5-2.0	0.1-0.30	○																
	DNMG150604-XF	0.4	0.5-2.5	0.1-0.25	●	●															
	DNMG150608-XF	0.8	0.5-2.5	0.1-0.30	●	●															
	DNMG150612-XF	1.2	0.5-2.5	0.1-0.35	●	●															
XM 	DNMG110404-XM	0.4	1-3.85	0.2-0.4	●	○															
	DNMG110408-XM	0.8	1-3.85	0.2-0.4	●	○															
	DNMG110412-XM	1.2	1-3.85	0.2-0.6	●	○															
	DNMG150604-XM	0.4	1-5.25	0.2-0.4	●	●															
	DNMG150608-XM	0.8	1-5.25	0.2-0.4	●	●															
	DNMG150612-XM	1.2	1-5.25	0.2-0.6	●	●															
	DNMG150616-XM	1.6	1-5.25	0.2-0.65	●	●															

● Ex stock ○ On demand

HC¹ Coated carbide
HT Uncoated cermet
HC² Coated cermet
HW Uncoated carbide

Tool holder

DDJNR/L	PDJNR/L	PDNNR/L	MDJNR/L	MDPNN	S***-PDSNR/L	A***-PDUNR/L
Kr: 93°	Kr: 93°	Kr: 63°	Kr: 93°	Kr: 62°30'	Kr: 62°30'	Kr: 93°
A231	A240	A241	A254	A255	A326	A327

System code > A48

Grade selection > A42

Technical info > A501

Cutting data > A366



A

Turning

B

Milling

C

Drilling

D

Technical Information

E

Index

- Ideal machining conditions
- ⊗ Normal machining conditions
- ⊗ Unfavourable machining conditions

DNMG	L	I.C	S	d
11 04	11.6	9.525	4.76	3.81
15 04	15.5	12.7	4.76	5.16
15 06	15.5	12.7	6.35	5.16

Turning inserts

DN** negative insert	HC ¹ (CVD)					HC ¹ (PVD)		HT	HC ²	HW
	P	M	K	N	S	H				
	●●●●●	●●●●●	●●●●●	●●●●●	●●●●●	●●●●●	●●●●●	●●●●●	●●●●●	●●●●●
	●●●●●	●●●●●	●●●●●	●●●●●	●●●●●	●●●●●	●●●●●	●●●●●	●●●●●	●●●●●

ISO	r	a _p	f	YBC103	YB6315	YBC152	YBC203	YBC252	YBC352	YBM153	YBM253	YBD102	YB7315	YBD152	YBD152C	YBG101	YBG102	YBG105	YBG205	YB9320	YPD201	YBS103	YNG151	YNT251	YNG151C	YD101	YD201
				DM	0.4	0.4-5.0	0.1-0.3	●	●																		
DM	0.8	0.5-5.0	0.15-0.50	●	●																						
DM	1.2	0.8-5.0	0.18-0.50	●	●																						
DM	0.4	0.4-6.0	0.1-0.3	●	●																						
DM	0.8	0.5-6.0	0.15-0.50	●	●																						
DM	1.2	0.8-6.0	0.18-0.60	○	●																						
DM	1.6	1-6	0.23-0.65	○	●																						
PM	0.4	0.4-5.0	0.1-0.3						●			○															
PM	0.8	0.5-5.0	0.15-0.50			○	●					●															
PM	1.2	0.8-5.0	0.18-0.50					○				●															
PM	0.4	0.4-6.0	0.1-0.3			○																					
PM	0.8	0.5-6.0	0.15-0.50			●	●					●	●														
PM	1.2	0.8-6.0	0.18-0.60					○																			
PM	1.6	1-6	0.23-0.65					○																			
PM	0.4	0.4-6.0	0.1-0.3			●	●					●	○														
PM	0.8	0.5-6.0	0.15-0.50			●	●	●				●	●														
PM	1.2	0.8-6.0	0.18-0.60			●	●					●	●														
PM	1.6	1-6	0.23-0.65					●																			

● Ex stock ○ On demand
 YBC152F, YBC252F, YBM153F, YBM253F available

HC¹ Coated carbide
 HT Uncoated cermet
 HC² Coated cermet
 HW Uncoated carbide

Tool holder						
DDJNR/L	PDJNR/L	PDNRR/L	MDJNR/L	MDPNN	S***-PDSNR/L	A***-PDUNR/L
Kr: 93°	Kr: 93°	Kr: 63°	Kr: 93°	Kr: 62°30'	Kr: 62°30'	Kr: 93°
A231	A240	A241	A254	A255	A326	A327



- Ideal machining conditions
- Normal machining conditions
- Unfavourable machining conditions

DNMG	L	I.C	S	d
15 06	15.5	12.7	6.35	5.16

Turning inserts

DN** negative insert				HC ¹ (CVD)								HC ¹ (PVD)			HT	HC ²	HW											
				P	●●●●●●●●●●									●●	●●	●●												
				M					●●						●●	●●	●●											
				K								●●●●																
				N										●●				●●	●●									
				S												●●	●●	●●	●●	●●								
				H																								
ISO	r	a _p	f	YBC103	YB6315	YBC152	YBC203	YBC252	YBC352	YBM153	YBM253	YBD102	YB7315	YBD152	YBD152C	YBG101	YBG102	YBG105	YBG205	YB9320	YPD201	YBS103	YNG151	YNT251	YNG151C	YD101	YD201	
ZM	DNMG150612-ZM	1.2	1.0-5.5	0.15-0.60	○	●																						
Medium Cut																												

● Ex stock ○ On demand
 YBC152F, YBC252F, YBM153F, YBM253F available

HC¹ Coated carbide
 HT Uncoated cermet
 HC² Coated cermet
 HW Uncoated carbide

Tool holder						
DDJNR/L	PDJNR/L	PDNNR/L	MDJNR/L	MDPNN	S***-PDSNR/L	S***-PDUNR/L
Kr: 93°	Kr: 93°	Kr: 63°	Kr: 93°	Kr: 62°30'	Kr: 62°30'	Kr: 93°
A231	A240	A241	A254	A255	A326	A327

A

Turning

B

Milling

C

Drilling

D

Technical Information

E

Index

- Ideal machining conditions
- ⊗ Normal machining conditions
- ⊛ Unfavourable machining conditions

DN**	L	I.C	S	d
11 04	11.6	9.525	4.76	3.81
15 04	15.5	12.7	4.76	5.16
15 06	15.5	12.7	6.35	5.16

Turning inserts

DN** negative insert				HC ¹ (CVD)								HC ¹ (PVD)		HT	HC ²	HW																
	P	M	K	N	S	H																										
	ISO				r	a _p	f	YBC103	YB6315	YBC152	YBC203	YBC252	YBC352	YBM153	YBM253	YBD102	YB7315	YBD152	YBD152C	YBG101	YBG102	YBG105	YBG205	YB9320	YPD201	YBS103	YNG151	YNT251	YNG151C	YD101	YD201	
	EF	DNMG110404-EF				0.4	0.1-1.5	0.05-0.20							○								●									
		DNMG110408-EF				0.8	0.1-1.5	0.1-0.4							○									●								
	Finishing	DNMG150404-EF				0.4	0.1-1.5	0.05-0.30																●								
		DNMG150408-EF				0.8	0.1-1.5	0.1-0.4																●								
DNMG150604-EF				0.4	0.1-1.5	0.05-0.30							●									●										
DNMG150608-EF				0.8	0.1-1.5	0.1-0.4							●									●										
Finishing	DNMG150612-EF				1.2	0.1-1.5	0.15-0.50																●									
	DNMG150604L-FM				0.4	0.5-3.0	0.05-0.30						●										●									
	DNMG150604R-FM				0.4	0.5-3.0	0.05-0.30			●		●											●									
	DNMG150608L-FM				0.8	0.5-3.0	0.1-0.5			○		●												●								
Finishing	DNMG150608R-FM				0.8	0.5-3.0	0.1-0.5			●		●											●									
	DNEG150404-NF				0.4	0.2-3.0	0.05-0.30																○									
	DNEG150408-NF				0.8	0.2-3.0	0.1-0.4																○									
	DNEG150604-NF				0.4	0.2-3.0	0.05-0.30																○	●						○		
Finishing	DNEG150608-NF				0.8	0.2-3.0	0.1-0.4																○	●						○		
	DNEG150608-NGF				0.8	0.2-3.0	0.05-0.40																●									
Finishing	DNEG150612-NGF				1.2	0.2-3.0	0.1-0.5																●									

● Ex stock ○ On demand
 YBC152F, YBC252F, YBM153F, YBM253F available

HC¹ Coated carbide
 HT Uncoated cermet
 HC² Coated cermet
 HW Uncoated carbide

Tool holder						
DDJNR/L	PDJNR/L	PDNNR/L	MDJNR/L	MDPNN	S***-PDSNR/L	A***-PDUNR/L
Kr: 93°						
A231	A240	A241	A254	A255	A326	A327



DNMG	L	I.C	S	d
11 04	11.6	9.525	4.76	3.81
15 04	15.5	12.7	4.76	5.16
15 06	15.5	12.7	6.35	5.16

- Ideal machining conditions
- ⊗ Normal machining conditions
- ⊗ Unfavourable machining conditions

Turning inserts

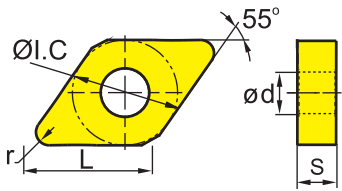

DN** negative insert				HC ¹ (CVD)								HC ¹ (PVD)			HT	HC ²	HW													
				P	M	K	N	S	H																					
ISO				r	a _p	f	YBC103	YB6315	YBC152	YBC203	YBC252	YBC352	YBM153	YBM253	YBD102	YBD152	YBD152C	YBG101	YBG102	YBG105	YBG205	YB9320	YPD201	YBS103	YNG151	YNT251	YNG151C	YD101	YD201	
EG	DNMG150604-EG	0.4	1-3	0.05-0.30									●																	
	DNMG150608-EG	0.8	1-3	0.1-0.4									● ○																	
	DNMG150612-EG	1.2	1-3	0.2-0.6									● ●																	
Medium Cut																														
EM	DNMG110404-EM	0.4	0.5-4.4	0.05-0.30									●																	
	DNMG110408-EM	0.8	0.5-4.4	0.10-0.45									●																	
	DNMG150404-EM	0.4	0.5-6.4	0.05-0.30									○																	
	DNMG150408-EM	0.8	0.5-6.4	0.10-0.45									○																	
	DNMG150412-EM	1.2	0.5-6.4	0.1-0.6									○																	
	DNMG150604-EM	0.4	0.2-6.4	0.05-0.30									● ●																	
	DNMG150608-EM	0.8	0.5-6.4	0.10-0.45									● ●																	
DNMG150612-EM	1.2	0.5-6.4	0.1-0.6									● ●																		
Medium Cut																														
NM	DNMG150412-NM	1.2	0.2-4.0	0.2-0.6																○										
	DNMG150608-NM	0.8	0.2-4.0	0.1-0.4																●										
	DNMG150612-NM	1.2	0.2-4.0	0.2-0.6																○ ●										
Medium Cut																														
TC	DNMG150608-TC	0.8	0.5-5.0	0.15-0.40											●		●													
	DNMG150612-TC	1.2	0.5-5.0	0.2-0.6											●		○													
Medium Cut																														

● Ex stock ○ On demand
 YBC152F, YBC252F, YBM153F, YBM253F available

HC¹ Coated carbide
 HT Uncoated cermet
 HC² Coated cermet
 HW Uncoated carbide

Tool holder						
DDJNR/L	PDJNR/L	PDNNR/L	MDJNR/L	MDPNN	S***-PDSNR/L	A***-PDUNR/L
Kr: 93°	Kr: 93°	Kr: 63°	Kr: 93°	Kr: 62°30'	Kr: 62°30'	Kr: 93°
A231	A240	A241	A254	A255	A326	A327



A Turning
B Milling
C Drilling
D Technical Information
E Index

General turning Negative inserts

A

Turning

- Ideal machining conditions
- ⊗ Normal machining conditions
- ⊗ Unfavourable machining conditions

DNMG	L	I.C	S	d
15 06	15.5	12.7	6.35	5.16

Turning inserts

DN** negative insert				HC ¹ (CVD)								HC ¹ (PVD)		HT	HC ²	HW											
				P	M	K	N	S	H																		
ISO	r	a _p	f	YBC103	YB6315	YBC152	YBC203	YBC252	YBC352	YBM153	YBM253	YBD102	YB7315	YBD152	YBD152C	YBG101	YBG102	YBG105	YBG205	YB9320	YPD201	YBS103	YNG151	YNT251	YNG151C	YD101	YD201
TK	DNMG150608-TK	0.8	0.2-0.4	0.2-0.4																							
	DNMG150612-TK	1.2	0.2-0.4	0.2-0.45																							
Medium Cut																											
DR	DNMG150608-DR	0.8	1-6	0.2-0.5																							
	DNMG150612-DR	1.2	1-6	0.25-0.70																							
	DNMG150616-DR	1.6	1-6	0.32-0.75																							
Roughing																											
SNR	DNMG150608-SNR	0.8	0.2-6.0	0.1-0.5																							
	DNMG150612-SNR	1.2	0.2-6.0	0.2-0.6																							
Roughing																											

● Ex stock ○ On demand
 YBC152F, YBC252F, YBM153F, YBM253F available

HC¹ Coated carbide
 HT Uncoated cermet
 HC² Coated cermet
 HW Uncoated carbide

B

Milling

C

Drilling

D

Technical Information

E

Index

Tool holder						
DDJNR/L	PDJNR/L	PDNNR/L	MDJNR/L	MDPNN	S***-PDSNR/L	S***-PDUNR/L
Kr: 93°	Kr: 93°	Kr: 63°	Kr: 93°	Kr: 62°30'	Kr: 62°30'	Kr: 93°
A231	A240	A241	A254	A255	A326	A327



- Ideal machining conditions
- Normal machining conditions
- Unfavourable machining conditions

DN**	L	I.C	S	d
15 06	15.5	12.7	6.35	5.16

Turning inserts

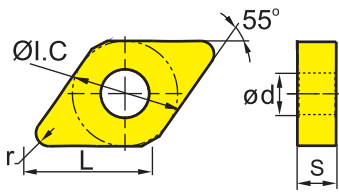

DN** negative insert				HC ¹ (CVD)						HC ¹ (PVD)			HT	HC ²	HW													
				P	●●●●●●●●●●							●●●●●●●●	●●●●●●															
				M		●●●●●●●●●●					●●●●●●●●	●●●●●●																
				K			●●●●●●●●●●																					
				N				●●●●●●●●						●●●●●●	●●●●●●													
				S					●●●●●●●●						●●●●●●													
				H																								
ISO	r	a _p	f	YBC103	YB6315	YBC152	YBC203	YBC252	YBC352	YBM153	YBM253	YBD102	YB7315	YBD152	YBD152C	YBG101	YBG102	YBG105	YBG205	YB9320	YPD201	YBS103	YNG151	YNT251	YNG151C	YD101	YD201	
Flat 	DNMA150604	0.4	0.2-6.0	0.1-0.3								●	○															
	DNMA150608	0.8	0.2-6.0	0.1-0.6								●	●															
	DNMA150612	1.2	0.2-6.0	0.15-0.70								●	●															
	DNMA150616	1.6	0.2-6.0	0.2-0.8											○													
Medium Cut																												
	ER	DNMG150608-ER	0.8	2-6	0.15-0.55						○																	
	DNMG150612-ER	1.2	2-6	0.25-0.80						○																		
Roughing																												

● Ex stock ○ On demand
 YBC152F, YBC252F, YBM153F, YBM253F available

HC¹ Coated carbide
 HT Uncoated cermet
 HC² Coated cermet
 HW Uncoated carbide

Tool holder

DDJNR/L	PDJNR/L	PDNNR/L	MDJNR/L	MDPNN	S***-PDSNR/L	S***-PDUNR/L
Kr: 93°	Kr: 93°	Kr: 63°	Kr: 93°	Kr: 62°30'	Kr: 62°30'	Kr: 93°
A231	A240	A241	A254	A255	A326	A327

System code > A48

Grade selection > A42

Technical info > A501

Cutting data > A366



A

Turning

B

Milling

C

Drilling

D

Technical Information

E

Index

A

Turning

- Ideal machining conditions
- ⊗ Normal machining conditions
- ⊗ Unfavourable machining conditions

DNMM	L	I.C	S	d
15 06	15.5	12.7	6.35	5.16

Turning inserts

DN** negative insert		HC ¹ (CVD)						HC ¹ (PVD)			HT	HC ²	HW		
	P	●	●	●	⊗	⊗	⊗				●	⊗	●		
	M				●	⊗		●	●	⊗	⊗	●	●		
	K							●	●	⊗	⊗				
	N							●	●					●	⊗
	S									●	●	⊗	⊗		●
	H														

B

Milling

	ISO	r	a _p	f	YBC103	YB6315	YBC152	YBC203	YBC252	YBC352	YBM153	YBM253	YBD102	YB7315	YBD152	YBD152C	YBG101	YBG102	YBG105	YBG205	YB9320	YPD201	YBS103	YNG151	YNT251	YNG151C	YD101	YD201		
					DR	DNMM150608-DR	0.8	0.7-6.0	0.20-0.55		●	●																		
	DNMM150612-DR	1.2	1-6	0.25-0.70		●	●	●																						
	DNMM150616-DR	1.6	1.5-6.0	0.32-0.90		●	●																							
Roughing																														
ER	DNMM150608-ER	0.8	0.7-6.0	0.20-0.55								○																		
	DNMM150612-ER	1.2	1-6	0.25-0.70								○																		
Roughing																														
HDR	DNMM150608-HDR	0.8	1-7	0.25-0.60		●	○																							
	DNMM150612-HDR	1.2	1-7	0.3-0.8		○																								
	DNMM150616-HDR	1.6	1.5-7.0	0.4-1.0		○																								
Roughing																														
LR	DNMM150608-LR	0.8	2-6	0.1-0.6		●	●			●																				
	DNMM150612-LR	1.2	2-6	0.2-0.8			●			○																				
	DNMM150616-LR	1.6	2-6	0.25-1.00		●	●																							
Roughing																														

C

Drilling

D

Technical Information

● Ex stock ○ On demand

YBC152F, YBC252F, YBM153F, YBM253F available

HC¹ Coated carbide
 HT Uncoated cermet
 HC² Coated cermet
 HW Uncoated carbide

E

Index

Tool holder						
DDJNR/L Kr: 93°	PDJNR/L Kr: 93°	PDNNR/L Kr: 63°	MDJNR/L Kr: 93°	MDPNN Kr: 62°30'	S***-PDSNR/L Kr: 62°30'	S***-PDUNR/L Kr: 93°
A231	A240	A241	A254	A255	A326	A327

System code > A48

Grade selection > A42

Technical info > A501

Cutting data > A366

- Ideal machining conditions
- ⊗ Normal machining conditions
- ⊗ Unfavourable machining conditions

SNMG	L	I.C	S	d
09 03	9.525	9.525	3.18	3.81
12 04	12.7	12.7	4.76	5.16

Turning inserts

SN** negative insert				HC ¹ (CVD)								HC ¹ (PVD)			HT	HC ²	HW										
				P	M	K	N	S	H																		
ISO	r	a _p	f	YBC103	YB6315	YBC152	YBC203	YBC252	YBC352	YBM153	YBM253	YBD102	YB7315	YBD152	YBD152C	YBG101	YBG102	YBG105	YBG205	YB9320	YPD201	YBS103	YNG151	YNT251	YNG151C	YD101	YD201
ADF	SNMG120404-ADF	0.4	0.5-5.0	0.1-0.3	●															●							
	SNMG120408-ADF	0.8	0.5-5.0	0.12-0.50	●															●							
	SNMG120412-ADF	1.2	1-5	0.2-0.6	●															●							
Finishing																											
DF	SNMG120408-DF	0.8	0.3-1.5	0.1-0.4		●	●																				
	SNMG120412-DF	1.2	0.35-1.50	0.15-0.50		●	●																				
Finishing																											
SF	SNMG090304-SF	0.4	0.05-0.50	0.05-0.20																					●		
	SNMG090308-SF	0.8	0.05-0.50	0.10-0.35																					○		
	SNMG120404-SF	0.4	0.05-0.50	0.05-0.20																					○		
	SNMG120408-SF	0.8	0.05-0.50	0.10-0.35																					○		
Finishing																											

● Ex stock ○ On demand
 YBC152F, YBC252F, YBM153F, YBM253F available

HC¹ Coated carbide
 HT Uncoated cermet
 HC² Coated cermet
 HW Uncoated carbide

Tool holder						
DSBNR/L	PSBNR/L	PSDNN	PSKNR/L	PSSNR/L	MSBNR/L	MSRNR/L
Kr: 75°	Kr: 75°	Kr: 45°	Kr: 75°	Kr: 45°	Kr: 75°	Kr: 75°
A232	A242	A244	A245	A246	A256	A257
MSKNR/L	MSDNN	S***-PSKNR/L				
Kr: 75°	Kr: 45°	Kr: 75°				
A258	A259	A329				

A

Turning

B

Milling

C

Drilling

D

Technical Information

E

Index

- Ideal machining conditions
- ⊗ Normal machining conditions
- ⊗ Unfavourable machining conditions

SNMG	L	I.C	S	d
09 03	9.525	9.525	3.18	3.81
12 04	12.7	12.7	4.76	5.16
15 06	15.875	15.875	6.35	6.35

Turning inserts

SN** negative insert				HC ¹ (CVD)								HC ¹ (PVD)		HT	HC ²	HW																
	P	M	K	N	S	H	YBC103	YB6315	YBC152	YBC203	YBC252	YBC352	YBM153	YBM253	YBD102	YB7315	YBD152	YBD152C	YBG101	YBG102	YBG105	YBG205	YB9320	YPD201	YBS103	YNG151	YNT251	YNG151C	YD101	YD201		
	ISO	r	a _p	f																												
		SNMG090304-EF	0.4	0.5-2.0	0.05-0.30									●									●									
		SNMG090308-EF	0.8	0.5-2.0	0.05-0.40									●										●								
		SNMG090312-EF	1.2	0.5-2.0	0.05-0.45									○																		
		SNMG120404-EF	0.4	0.8-3.0	0.05-0.30																				●							
SNMG120408-EF		0.8	0.8-3.0	0.1-0.4																				●								
SNMG120412-EF		1.2	0.8-3.0	0.15-0.45										○										●								
SNMG150608-EF		0.8	1-4	0.1-0.4										○																		
SNMG150612-EF		1.2	1-4	0.15-0.45										○																		

● Ex stock ○ On demand
 YBC152F, YBC252F, YBM153F, YBM253F available

HC¹ Coated carbide
 HT Uncoated cermet
 HC² Coated cermet
 HW Uncoated carbide

Tool holder						
DSB NR/L	PSB NR/L	PSD NN	PSK NR/L	PSS NR/L	MSB NR/L	MSR NR/L
Kr: 75°	Kr: 75°	Kr: 45°	Kr: 75°	Kr: 45°	Kr: 75°	Kr: 75°
A232	A242	A244	A245	A246	A256	A257
MSK NR/L	MSD NN	S***-PSK NR/L				
Kr: 75°	Kr: 45°	Kr: 75°				
A258	A259	A329				



SNMG	L	I.C	S	d
12 04	12.7	12.7	4.76	5.16
15 06	15.875	15.875	6.35	6.35
19 06	19.05	19.05	6.35	7.94

- Ideal machining conditions
- ⊗ Normal machining conditions
- ⊗ Unfavourable machining conditions

Turning inserts

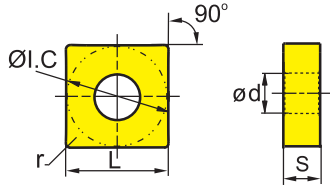

		HC ¹ (CVD)						HC ¹ (PVD)					HT	HC ²	HW																
		P	M	K	N	S	H																								
	ISO	r	a _p	f	YBC103	YB6315	YBC152	YBC203	YBC252	YBC352	YBM153	YBM253	YBD102	YBD315	YBD152	YBD152C	YBG101	YBG102	YBG105	YBG205	YB9320	YPD201	YBS103	YNG151	YNT251	YNG151C	YD101	YD201			
XF 	SNMG120404-XF	0.4	0.5-2.5	0.1-0.25	●	●																									
	SNMG120408-XF	0.8	0.5-2.5	0.1-0.30	●	●																									
XM 	SNMG120404-XM	0.4	1-4.2	0.2-0.4	○	○																									
	SNMG120408-XM	0.8	1-4.2	0.2-0.4	●	●																									
	SNMG120412-XM	1.2	1-4.2	0.2-0.6	●	●																									
	SNMG120416-XM	1.6	1-4.2	0.2-0.65	○	○																									
	SNMG150608-XM	0.8	1-5.25	0.2-0.4	●	●																									
	SNMG150612-XM	1.2	1-5.25	0.2-0.6	●	●																									
	SNMG150616-XM	1.6	1-5.25	0.2-0.65	○	●																									
	SNMG190608-XM	0.8	1-6.65	0.2-0.4	○	○																									
	SNMG190612-XM	1.2	1-6.65	0.2-0.6	○	○																									
	SNMG190616-XM	1.6	1-6.65	0.2-0.65	○	○																									
SNMG190624-XM	2.4	1-6.65	0.2-1.2	○	○																										

● Ex stock ○ On demand

HC¹ Coated carbide
 HT Uncoated cermet
 HC² Coated cermet
 HW Uncoated carbide

Tool holder

DSBNR/L	PSBNR/L	PSDNN	PSKNR/L	PSSNR/L	MSBNR/L	MSRNR/L
Kr: 75°	Kr: 75°	Kr: 45°	Kr: 75°	Kr: 45°	Kr: 75°	Kr: 75°
A232	A242	A244	A245	A246	A256	A257
MSKNR/L	MSDNN	S***-PSKNR/L				
Kr: 75°	Kr: 45°	Kr: 75°				
A258	A259	A329				

System code > A48

Grade selection > A42

Technical info > A501

Cutting data > A366



A

Turning

B

Milling

C

Drilling

D

Technical Information

E

Index

SNMG	L	I.C	S	d
09 03	9.525	9.525	3.18	3.81
12 04	12.7	12.7	4.76	5.16
15 06	15.875	15.875	6.35	6.35
19 06	19.05	19.05	6.35	7.94

- Ideal machining conditions
- ⊗ Normal machining conditions
- ⊗ Unfavourable machining conditions

Turning inserts

SN** negative insert				HC ¹ (CVD)								HC ¹ (PVD)			HT	HC ²	HW											
ISO	r	a _p	f	P	M	K	N	S	H																			
				YBC103	YB6315	YBC152	YBC203	YBC252	YBC352	YBM153	YBM253	YBD102	YB7315	YBD152	YBD152C	YBG101	YBG102	YBG105	YBG205	YB9320	YPD201	YBS103	YNG151	YNT251	YNG151C	YD101	YD201	
PM  Medium Cut	SNMG090304-PM	0.4	0.4-4.5	0.1-0.3	●	●	●	●	●	●																		
	SNMG090308-PM	0.8	0.5-4.5	0.15-0.50																								
	SNMG090312-PM	1.2	0.6-4.5	0.2-0.6																								
	SNMG120404-PM	0.4	0.4-6.0	0.1-0.3			●	○																				
	SNMG120408-PM	0.8	0.5-6.0	0.15-0.50			●	●			○																	
	SNMG120412-PM	1.2	0.8-6.0	0.18-0.60			●	●			○																	
	SNMG120416-PM	1.6	1-6	0.23-0.65			○	○			○	○																
	SNMG150608-PM	0.8	0.7-7.5	0.14-0.50			○	○																				
	SNMG150612-PM	1.2	0.8-7.5	0.18-0.60			○	●			●	●																
	SNMG190612-PM	1.2	1.0-7.5	0.20-0.65			○	●			●	●																

● Ex stock ○ On demand
 YBC152F, YBC252F, YBM153F, YBM253F available

HC¹ Coated carbide
 HT Uncoated cermet
 HC² Coated cermet
 HW Uncoated carbide

Tool holder

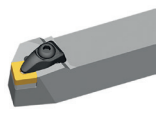
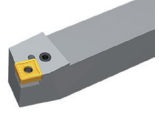
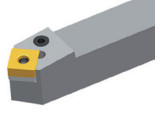
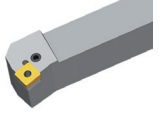
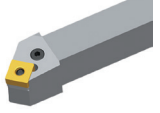
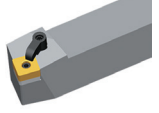
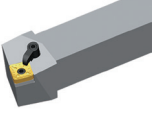
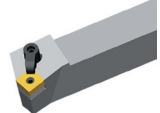
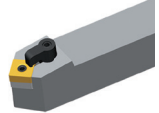
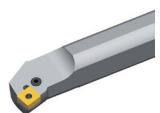
DSBNR/L	PSBNR/L	PSDNN	PSKNR/L	PSSNR/L	MSBNR/L	MSRNR/L
Kr: 75°	Kr: 75°	Kr: 45°	Kr: 75°	Kr: 45°	Kr: 75°	Kr: 75°
						
A232	A242	A244	A245	A246	A256	A257
MSKNR/L	MSDNN	S***-PSKNR/L				
Kr: 75°	Kr: 45°	Kr: 75°				
						
A258	A259	A329				



SNMG	L	I.C	S	d
09 03	9.525	9.525	3.18	3.81
12 04	12.7	12.7	4.76	5.16
15 06	15.875	15.875	6.35	6.35
19 06	19.05	19.05	6.35	7.94

- Ideal machining conditions
- ⊗ Normal machining conditions
- ⊗ Unfavourable machining conditions

Turning inserts

SN** negative insert				HC ¹ (CVD)								HC ¹ (PVD)			HT	HC ²	HW										
				P	M	K	N	S	H																		
ISO	r	a _p	f	YBC103	YB6315	YBC152	YBC203	YBC252	YBC352	YBM153	YBM253	YBD102	YB7315	YBD152	YBD152C	YBG101	YBG102	YBG105	YBG205	YB9320	YPD201	YBS103	YNG151	YNT251	YNG151C	YD101	YD201
DM Medium Cut	SNMG090304-DM	0.4	0.4-4.5	0.1-0.3	●	●																					
	SNMG090308-DM	0.8	0.5-4.5	0.15-0.50	●	●																					
	SNMG120404-DM	0.4	0.4-6.0	0.1-0.3	●	●																					
	SNMG120408-DM	0.8	0.5-6.0	0.15-0.50	●	●	○																				
	SNMG120412-DM	1.2	0.8-6.0	0.18-0.60	●	●																					
	SNMG120416-DM	1.6	1-6	0.23-0.65	○	●																					
	SNMG150608-DM	0.8	0.8-7.5	0.1-0.5	●	●																					
	SNMG150612-DM	1.2	0.8-7.5	0.18-0.60	●	●																					
	SNMG190612-DM	1.2	1-9	0.18-0.60	●	●																					
	SNMG190616-DM	1.6	1-9	0.23-0.65	○	●																					
EG Medium Cut	SNMG120408-EG	0.8	0.5-4.0	0.1-0.5						●								●	●								
	SNMG120412-EG	1.2	0.5-4.0	0.2-0.6							●								●								

● Ex stock ○ On demand
 YBC152F, YBC252F, YBM153F, YBM253F available

HC¹ Coated carbide
 HT Uncoated cermet
 HC² Coated cermet
 HW Uncoated carbide

Tool holder						
DSBNR/L	PSBNR/L	PSDNN	PSKNR/L	PSSNR/L	MSBNR/L	MSRNR/L
Kr: 75°	Kr: 75°	Kr: 45°	Kr: 75°	Kr: 45°	Kr: 75°	Kr: 75°
A232	A242	A244	A245	A246	A256	A257
MSKNR/L	MSDNN	S***-PSKNR/L				
Kr: 75°	Kr: 45°	Kr: 75°				
A258	A259	A329				

General turning Negative inserts

A



Turning

- Ideal machining conditions
- ⊗ Normal machining conditions
- ⊗ Unfavourable machining conditions

SNMG	L	I.C	S	d
12 04	12.7	12.7	4.76	5.16
15 06	15.875	15.875	6.35	6.35

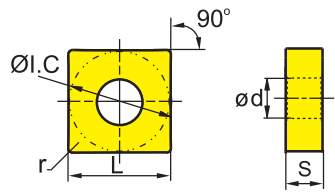
Turning inserts



SN** negative insert				HC ¹ (CVD)								HC ¹ (PVD)		HT	HC ²	HW													
				P	M	K	N	S	H																				
	ISO	r	a _p	f	YBC103	YB6315	YBC152	YBC203	YBC252	YBC352	YBM153	YBM253	YBD102	YB7315	YBD152	YBD152C	YBG101	YBG102	YBG105	YBG205	YB9320	YPD201	YBS103	YNG151	YNT251	YNG151C	YD101	YD201	
EM  Medium Cut	SNMG120404-EM	0.4	0.50-6.35	0.05-0.30																●									
	SNMG120408-EM	0.8	0.50-6.35	0.20-0.45							●	●								●									
	SNMG120412-EM	1.2	0.50-6.35	0.25-0.60							●	●								●									
	SNMG120416-EM	1.6	0.50-6.35	0.30-0.75																									
	SNMG150612-EM	1.2	0.5-8.0	0.25-0.60							○	●									●								
	SNMG150616-EM	1.6	0.5-8.0	0.30-0.75																	●								
TC  Medium Cut	SNMG120404-TC	0.4	0.5-5.0	0.08-0.25										●															
	SNMG120408-TC	0.8	0.5-5.0	0.15-0.40										●	●														
	SNMG120412-TC	1.2	0.5-5.0	0.2-0.5										●	●														
	SNMG150616-TC	1.6	1-7	0.2-0.7										●															
TK  Medium Cut	SNMG120412-TK	1.2	0.2-0.4	0.2-0.45										●															

● Ex stock ○ On demand
YBC152F, YBC252F, YBM153F, YBM253F available

HC¹ Coated carbide
HT Uncoated cermet
HC² Coated cermet
HW Uncoated carbide

B

Milling

C

Drilling

D

Technical Information

E

Index

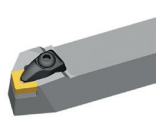
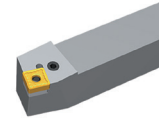
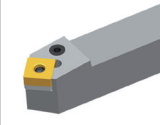
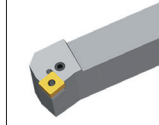
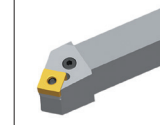
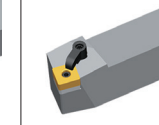
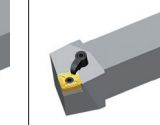
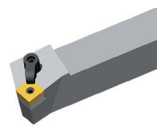
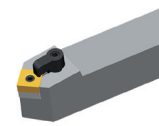
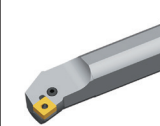
Tool holder						
DSBNR/L	PSBNR/L	PSDNN	PSKNR/L	PSSNR/L	MSBNR/L	MSRNR/L
Kr: 75°	Kr: 75°	Kr: 45°	Kr: 75°	Kr: 45°	Kr: 75°	Kr: 75°
						
A232	A242	A244	A245	A246	A256	A257
MSKNR/L	MSDNN	S***-PSKNR/L				
Kr: 75°	Kr: 45°	Kr: 75°				
						
A258	A259	A329				



SNMG	L	I.C	S	d
12 04	12.7	12.7	4.76	5.16
15 06	15.875	15.875	6.35	6.35
19 06	19.05	19.05	6.35	7.94
25 09	25.4	25.4	9.525	9.12

- Ideal machining conditions
- ⊗ Normal machining conditions
- ⊗ Unfavourable machining conditions

Turning inserts

SN** negative insert					HC ¹ (CVD)								HC ¹ (PVD)			HT	HC ²	HW										
					P	M	K	N	S	H																		
ISO	r	a _p	f	YBC103	YB6315	YBC152	YBC203	YBC252	YBC352	YBM153	YBM253	YBD102	YB7315	YBD152	YBD152C	YBG101	YBG102	YBG105	YBG205	YB9320	YPD201	YBS103	YNG151	YNT251	YNG151C	YD101	YD201	
 Medium Cut	SNMG120408-NM	0.8	0.5-5.0	0.1-0.4												○		●								○		
	SNMG120412-NM	1.2	0.5-5.0	0.15-0.50														○										
 DR Roughing	SNMG120408-DR	0.8	0.7-7.0	0.2-0.5		○	●				●	●																
	SNMG120412-DR	1.2	1-7	0.25-0.70		●	●	●				○	●															
	SNMG120416-DR	1.6	1.5-7.0	0.32-0.75		○	●					●	●															
	SNMG150612-DR	1.2	1-8	0.25-0.70					●				○	●														
	SNMG150616-DR	1.6	1.5-8.0	0.3-0.8		○	●						○	○														
	SNMG190612-DR	1.2	1-10	0.25-0.70		●	●	●							●													
	SNMG190616-DR	1.6	1.5-10.0	0.3-0.8	○	●	●	●					○	●														
SNMG190624-DR	2.4	2-10	0.32-0.90					●	○																			
SNMG250924-DR	2.4	2-15	0.4-1.2					●	○																			

● Ex stock ○ On demand
 YBC152F, YBC252F, YBM153F, YBM253F available

HC¹ Coated carbide
 HT Uncoated cermet
 HC² Coated cermet
 HW Uncoated carbide

Tool holder						
DSBNR/L Kr: 75°	PSBNR/L Kr: 75°	PSDNN Kr: 45°	PSKNR/L Kr: 75°	PSSNR/L Kr: 45°	MSBNR/L Kr: 75°	MSRNR/L Kr: 75°
A232	A242	A244	A245	A246	A256	A257
MSKNR/L Kr: 75°	MSDNN Kr: 45°	S***-PSKNR/L Kr: 75°				
A258	A259	A329				

A Turning
 B Milling
 C Drilling
 D Technical Information
 E Index

A

Turning

B

Milling

C

Drilling

D

Technical Information

E

Index

- Ideal machining conditions
- ⊗ Normal machining conditions
- ⊗ Unfavourable machining conditions

SNMG	L	I.C	S	d
12 04	12.7	12.7	4.76	5.16
15 06	15.875	15.875	6.35	6.35
19 06	19.05	19.05	6.35	7.94

Turning inserts

SN** negative insert				HC ¹ (CVD)								HC ¹ (PVD)			HT	HC ²	HW										
				P	M	K	N	S	H																		
ISO	r	a _p	f	YBC103	YB6315	YBC152	YBC203	YBC252	YBC352	YBM153	YBM253	YBD102	YB7315	YBD152	YBD152C	YBG101	YBG102	YBG105	YBG205	YB9320	YPD201	YBS103	YNG151	YNT251	YNG151C	YD101	YD201
ER	SNMG120408-ER	0.8	2.0-7.6	0.20-0.55						○	○																
	SNMG120412-ER	1.2	2.0-7.6	0.3-0.6						○	○																
	SNMG150612-ER	1.2	2.0-9.6	0.3-0.6						○	○																
	SNMG190612-ER	1.2	2.0-11.4	0.3-0.6						○	○																
Roughing	SNMG190616-ER	1.6	2.0-11.4	0.35-0.80						○	○																
SNR	SNMG120408-SNR	0.8	1-4	0.2-0.6												●					●						

● Ex stock ○ On demand
 YBC152F, YBC252F, YBM153F, YBM253F available

HC¹ Coated carbide
 HT Uncoated cermet
 HC² Coated cermet
 HW Uncoated carbide

Tool holder

DSBNR/L	PSBNR/L	PSDNN	PSKNR/L	PSSNR/L	MSBNR/L	MSRNR/L
Kr: 75°	Kr: 75°	Kr: 45°	Kr: 75°	Kr: 45°	Kr: 75°	Kr: 75°
A232	A242	A244	A245	A246	A256	A257
MSKNR/L	MSDNN	S***-PSKNR/L				
Kr: 75°	Kr: 45°	Kr: 75°				
A258	A259	A329				

System code > A48

Grade selection > A42

Technical info > A501

Cutting data > A366



SNMM	L	I.C	S	d
15 06	15.875	15.875	6.35	6.35
19 06	19.05	19.05	6.35	7.94
25 07	25.4	25.4	7.94	9.12
25 09	25.4	25.4	9.525	9.12

- Ideal machining conditions
- Normal machining conditions
- Unfavourable machining conditions

Turning inserts

SN** negative insert					HC ¹ (CVD)								HC ¹ (PVD)		HT	HC ²	HW												
					P	M	K	N	S	H																			
ISO	r	a _p	f		YBC103	YB6315	YBC152	YBC203	YBC252	YBC352	YBM153	YBM253	YBD102	YB7315	YBD152	YBD152C	YBG101	YBG102	YBG105	YBG205	YB9320	YPD201	YBS103	YNG151	YNT251	YNG151C	YD101	YD201	
DR Roughing	SNMM150612-DR	1.2	1-7	0.25-0.60						●																			
	SNMM150616-DR	1.6	1.5-9.0	0.32-0.90			○			●	●																		
	SNMM190608-DR	0.8	2.0-10.5	0.25-0.50						○																			
	SNMM190612-DR	1.2	2.0-10.5	0.25-0.60						●	●	●																	
	SNMM190616-DR	1.6	2.0-10.5	0.35-0.90						●	●	●																	
	SNMM190624-DR	2.4	2.0-10.5	0.4-1.1						●	●	●																	
	SNMM250716-DR	1.6	2.5-12.5	0.4-1.0							●																		
	SNMM250724-DR	2.4	2.5-12.5	0.5-1.2						○	●																		
	SNMM250924-DR	2.4	2.5-12.5	0.5-1.2							●	●																	
ER Roughing	SNMM250724-ER	2.4	2.8-18.0	0.45-1.40						●	○	●																	
	SNMM250732-ER	3.2	2.8-18.0	0.32-1.40							●																		
	SNMM250924-ER	2.4	2.8-18.0	0.45-1.40							●	○	○																
	SNMM250932-ER	3.2	2.8-18.0	0.55-1.80							●																		

● Ex stock ○ On demand
 YBC152F, YBC252F, YBM153F, YBM253F available

HC¹ Coated carbide
 HT Uncoated cermet
 HC² Coated cermet
 HW Uncoated carbide

Tool holder						
DSBNR/L	PSBNR/L	PSDNN	PSKNR/L	PSSNR/L	MSBNR/L	MSRNR/L
Kr: 75°	Kr: 75°	Kr: 45°	Kr: 75°	Kr: 45°	Kr: 75°	Kr: 75°
A232	A242	A244	A245	A246	A256	A257
MSKNR/L	MSDNN					
Kr: 75°	Kr: 45°					
A258	A259					

A

Turning

B

Milling

C

Drilling

D

Technical Information

E

Index

SNMM	L	I.C	S	d
12 04	12.7	12.7	4.76	5.16
15 06	15.875	15.875	6.35	6.35
19 06	19.05	19.05	6.35	7.94
25 09	25.4	25.4	9.525	9.12

- Ideal machining conditions
- Normal machining conditions
- Unfavourable machining conditions



Turning inserts

SN** negative insert					HC ¹ (CVD)								HC ¹ (PVD)		HT	HC ²	HW												
ISO	r	a _p	f	YBC103	YB6315	YBC152	YBC203	YBC252	YBC352	YBM153	YBM253	YBD102	YB7315	YBD152	YBD152C	YBG101	YBG102	YBG105	YBG205	YB9320	YPD201	YBS103	YNG151	YNT251	YNG151C	YD101	YD201		
																												P	M
LR  Roughing	SNMM120408-LR	0.8	1-6	0.1-0.5	○	●																							
	SNMM120412-LR	1.2	1-6	0.2-0.6	○	●																							
	SNMM120416-LR	1.6	1-6	0.25-0.70				○																					
	SNMM150612-LR	1.2	1.5-7.0	0.1-0.5					●																				
	SNMM150616-LR	1.6	1.5-7.0	0.1-0.5				○	○																				
	SNMM190612-LR	1.2	2-10	0.25-0.70				○	●																				
	SNMM190616-LR	1.6	2-10	0.3-1.0				○	●																				
	SNMM190624-LR	2.4	2-10	0.3-1.1				○	●																				
	SNMM250924-LR	2.4	3.0-12.5	0.3-1.2				○	●	○																			

● Ex stock ○ On demand
 YBC152F, YBC252F, YBM153F, YBM253F available

HC¹ Coated carbide
 HT Uncoated cermet
 HC² Coated cermet
 HW Uncoated carbide

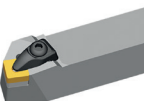
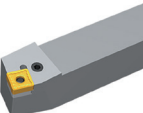
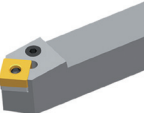
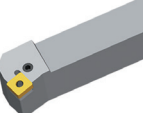
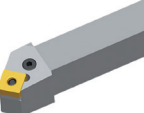
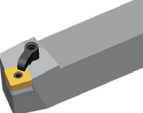
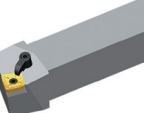
Tool holder

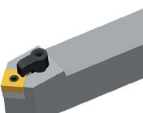
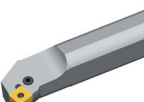
DSB NR/L Kr: 75°	PSB NR/L Kr: 75°	PSD NN Kr: 45°	PSK NR/L Kr: 75°	PSS NR/L Kr: 45°	MSB NR/L Kr: 75°	MSR NR/L Kr: 75°
						
A232	A242	A244	A245	A246	A256	A257
MSK NR/L Kr: 75°	MSD NN Kr: 45°	S***-PSK NR/L Kr: 75°				
						
A258	A259	A329				

System code > A48

Grade selection > A42

Technical info > A501

Cutting data > A366

SNMM	L	I.C	S	d
12 04	12.7	12.7	4.76	5.16
15 06	15.875	15.875	6.35	6.35
19 06	19.05	19.05	6.35	7.94
25 07	25.4	25.4	7.94	9.12
25 09	25.4	25.4	9.525	9.12

- Ideal machining conditions
- Normal machining conditions
- Unfavourable machining conditions

Turning inserts

SN** negative insert				HC ¹ (CVD)								HC ¹ (PVD)			HT	HC ²	HW											
				P	M	K	N	S	H																			
ISO	r	a _p	f	YBC103	YB6315	YBC152	YBC203	YBC252	YBC352	YBM153	YBM253	YBD102	YB7315	YBD152	YBD152C	YBG101	YBG102	YBG105	YBG205	YB9320	YPD201	YBS103	YNG151	YNT251	YNG151C	YD101	YD201	
HDR Roughing	SNMM120408-HDR	0.8	1-6	0.1-0.6					●																			
	SNMM120412-HDR	1.2	1.5-6.0	0.2-0.7					○																			
	SNMM150608-HDR	0.8	1-7	0.2-0.6						○																		
	SNMM150612-HDR	1.2	1-7	0.25-0.70			●	●																				
	SNMM150616-HDR	1.6	1.5-9.0	0.32-1.00						○																		
	SNMM190612-HDR	1.2	2.0-10.5	0.25-0.70			○	○																				
	SNMM190616-HDR	1.6	2.0-10.5	0.35-1.00			●	●			○																	
	SNMM190624-HDR	2.4	2.0-10.5	0.4-1.2			●	●																				
	SNMM250724-HDR	2.4	2.5-12.5	0.5-1.4							●																	
	SNMM250924-HDR	2.4	2.5-12.5	0.5-1.4			●	●	●																			

● Ex stock ○ On demand
 YBC152F, YBC252F, YBM153F, YBM253F available

HC¹ Coated carbide
 HT Uncoated cermet
 HC² Coated cermet
 HW Uncoated carbide

Tool holder						
DSBNR/L	PSBNR/L	PSDNN	PSKNR/L	PSSNR/L	MSBNR/L	MSRNR/L
Kr: 75°	Kr: 75°	Kr: 45°	Kr: 75°	Kr: 45°	Kr: 75°	Kr: 75°
A232	A242	A244	A245	A246	A256	A257
MSKNR/L	MSDNN	S***-PSKNR/L				
Kr: 75°	Kr: 45°	Kr: 75°				
A258	A259	A329				

General turning Negative inserts

A

Turning

- Ideal machining conditions
- Normal machining conditions
- Unfavourable machining conditions

SNMM	L	I.C	S	d
19 06	19.05	19.05	6.35	7.94
25 09	25.4	25.4	9.525	9.12

Turning inserts

SN** negative insert				HC ¹ (CVD)										HC ¹ (PVD)		HT	HC ²	HW												
				P	●	●	●	●	●	●	●	●	●	●	●	●	●	●	●	●										
				M	●	●	●	●	●	●	●	●	●	●	●	●	●	●	●	●	●									
				K	●	●	●	●	●	●	●	●	●	●	●	●	●	●	●	●	●	●								
				N	●	●	●	●	●	●	●	●	●	●	●	●	●	●	●	●	●	●								
				S	●	●	●	●	●	●	●	●	●	●	●	●	●	●	●	●	●	●								
				H	●	●	●	●	●	●	●	●	●	●	●	●	●	●	●	●	●	●								
ISO				r	a _p	f	YBC103	YB6315	YBC152	YBC203	YBC252	YBC352	YBM153	YBM253	YBD102	YB7315	YBD152	YBD152C	YBG101	YBG102	YBG105	YBG205	YB9320	YPD201	YBS103	YNG151	YNT251	YNG151C	YD101	YD201
HPR	SNMM190616-HPR	1.6	2.0-10.5	0.35-1.00								●																		
	SNMM190624-HPR	2.4	2.0-10.5	0.4-1.2			○					●																		
Roughing	SNMM250924-HPR	2.4	2.0-12.5	0.5-1.4			○					●	●																	

● Ex stock ○ On demand
 YBC152F, YBC252F, YBM153F, YBM253F available

HC¹ Coated carbide
 HT Uncoated cermet
 HC² Coated cermet
 HW Uncoated carbide

B

Milling

C

Drilling

D

Technical Information

E

Index

Tool holder						
PSBNR/L	PSDNN	PSKNR/L	PSSNR/L	MSBNR/L	MSRNR/L	MSKNR/L
Kr: 75°	Kr: 45°	Kr: 75°	Kr: 45°	Kr: 75°	Kr: 75°	Kr: 75°
A242	A244	A245	A246	A256	A257	A258



SNMG	L	I.C	S	d
12 04	12.7	12.7	4.76	5.16
25 07	25.4	25.4	7.94	9.12
25 09	25.4	25.4	9.525	9.12

- Ideal machining conditions
- ⊗ Normal machining conditions
- ⊗ Unfavourable machining conditions

Turning inserts

SN** negative insert		HC ¹ (CVD)					HC ¹ (PVD)			HT	HC ²	HW	
	P	●	●	●	⊗	⊗			●	⊗	●		
	M				●	⊗		●	●	⊗	⊗	●	
	K												
	N							●	●			●	⊗
	S								●	●	⊗	⊗	●
	H												

ISO		r	a _p	f	YBC103	YB6315	YBC152	YBC203	YBC252	YBC352	YBM153	YBM253	YBD102	YBD315	YBD152	YBD152C	YBG101	YBG102	YBG105	YBG205	YB9320	YPD201	YBS103	YNG151	YNT251	YNG151C	YD101	YD201	
Basic 	SNMG120408	0.8	0.5-6.0	0.1-0.6		●		●																					
	SNMG120412	1.2	0.5-6.0	0.1-0.7		○		○																					
	SNMG250724	2.4	1-9	0.1-1.1																									
	SNMG250924	2.4	1-9	0.1-1.1																									
Medium Cut																													

● Ex stock ○ On demand
 YBC152F, YBC252F, YBM153F, YBM253F available

HC¹ Coated carbide
 HT Uncoated cermet
 HC² Coated cermet
 HW Uncoated carbide

Tool holder						
DSBNR/L Kr: 75°	PSBNR/L Kr: 75°	PSDNN Kr: 45°	PSKNR/L Kr: 75°	PSSNR/L Kr: 45°	MSBNR/L Kr: 75°	MSRNR/L Kr: 75°
A232	A242	A244	A245	A246	A256	A257
MSKNR/L Kr: 75°	MSDNN Kr: 45°	S***-PSKNR/L Kr: 75°				
A258	A259	A329				

A

Turning

B

Milling

C

Drilling

D

Technical Information

E

Index

SN**	L	I.C	S	d
12 04	12.7	12.7	4.76	5.16
15 06	15.875	15.875	6.35	6.35
19 06	19.05	19.05	6.35	7.94
25 07	25.4	25.4	7.94	9.12

- Ideal machining conditions
- ⊗ Normal machining conditions
- ⊗ Unfavourable machining conditions

Turning inserts

SN** negative insert				HC ¹ (CVD)							HC ¹ (PVD)			HT	HC ²	HW																				
ISO	r	a _p	f	P	M	K	N	S	H	YBC103	YB6315	YBC152	YBC203	YBC252	YBC352	YBM153	YBM253	YBD102	YB7315	YBD152	YBD152C	YBG101	YBG102	YBG105	YBG205	YB9320	YPD201	YBS103	YNG151	YNT251	YNG151C	YD101	YD201			
				Flat	SNMA120408	0.8	0.5-5.0	0.1-0.5	●	●	●	●	●									●	●	●												
	SNMA120412	1.2	0.5-5.0	0.2-0.7														○	○	●	○															
	SNMA120416	1.6	0.5-5.0	0.2-1.0														○	●	○																
	SNMA150608	0.8	0.8-7.0	0.1-0.5																	○															
	SNMA150612	1.2	0.8-7.0	0.2-0.7																		●														
	SNMA190612	1.2	0.8-7.0	0.2-0.7															○		●															
	SNMA190616	1.6	0.8-7.0	0.3-0.8															○		●															
Basic	SNMM250724-1	2.4	2.0-12.5	0.3-1.2											●	●				○	●															

● Ex stock ○ On demand
 YBC152F, YBC252F, YBM153F, YBM253F available

HC¹ Coated carbide
 HT Uncoated cermet
 HC² Coated cermet
 HW Uncoated carbide



D

Technical Information

Tool holder						
DSBNR/L	PSBNR/L	PSDNN	PSKNR/L	PSSNR/L	MSBNR/L	MSRNR/L
Kr: 75°	Kr: 75°	Kr: 45°	Kr: 75°	Kr: 45°	Kr: 75°	Kr: 75°
A232	A242	A244	A245	A246	A256	A257
MSKNR/L	MSDNN	S***-PSKNR/L				
Kr: 75°	Kr: 45°	Kr: 75°				
A258	A259	A329				



Turning inserts

-  Ideal machining conditions
-  Normal machining conditions
-  Unfavourable machining conditions

SNMM	L	I.C	S	d
19 06	19.05	19.05	6.35	7.94
25 09	25.4	25.4	9.525	9.12

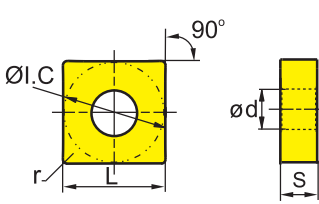
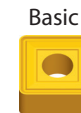
SN** negative insert				HC ¹ (CVD)					HC ¹ (PVD)			HT	HC ²	HW														
				P																								
				M																								
				K																								
				N																								
				S																								
				H																								
ISO	r	a _p	f	YBC103	YB6315	YBC152	YBC203	YBC252	YBC352	YBM153	YBM253	YBD102	YB7315	YBD152	YBD152C	YBG101	YBG102	YBG105	YBG205	YB9320	YPD201	YBS103	YNG151	YNT251	YNG151C	YD101	YD201	
	SNMM190612	1.2	1.5-10.5	0.2-0.7																								
	SNMM190616	1.6	0.5-10.5	0.2-1.0																								
	SNMM250924	2.4	2.0-12.5	0.3-1.2																								

● Ex stock ○ On demand
 YBC152F, YBC252F, YBM153F, YBM253F available

HC¹ Coated carbide
 HT Uncoated cermet
 HC² Coated cermet
 HW Uncoated carbide

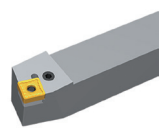
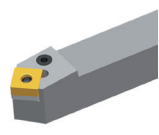
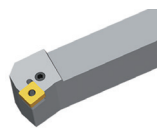
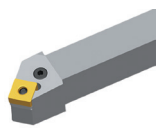
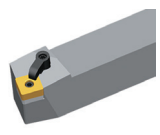
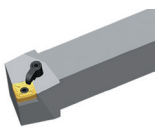
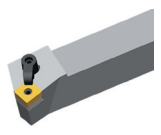
Tool holder						
PSBNR/L	PSDNN	PSKNR/L	PSSNR/L	MSBNR/L	MSRNR/L	MSKNR/L
Kr: 75°	Kr: 45°	Kr: 75°	Kr: 45°	Kr: 75°	Kr: 75°	Kr: 75°
						
A242	A244	A245	A246	A256	A257	A258

A

Turning

- Ideal machining conditions
- ⊗ Normal machining conditions
- ⊗ Unfavourable machining conditions

SNUN	L	I.C	S
12 04	12.7	12.7	4.76
19 04	19.05	19.05	4.76

Turning inserts

SN** negative insert				HC ¹ (CVD)										HC ¹ (PVD)		HT	HC ²	HW												
	P	M	K	N	S	H	YBC103	YB6315	YBC152	YBC203	YBC252	YBC352	YBM153	YBM253	YBD102	YB7315	YBD152	YBD152C	YBG101	YBG102	YBG105	YBG205	YB9320	YPD201	YBS103	YNG151	YNT251	YNG151C	YD101	YD201
	ISO	r	a _p	f																										
	Flat 	SNUN120408	0.8	0.7-6.0	0.2-0.5																									
		SNUN120412	1.2	0.7-6.0	0.25-0.60																									
		SNUN190412	1.2	0.9-6.0	0.25-0.60																									

● Ex stock ○ On demand

HC¹ Coated carbide
 HT Uncoated cermet
 HC² Coated cermet
 HW Uncoated carbide

B

Milling

C

Drilling

Tool holder		
CSKNR/L	CSRNR/L	CSDNN
Kr: 75°	Kr: 75°	Kr: 45°
A296	A297	A299

D

Technical Information

E

Index



- Ideal machining conditions
- Normal machining conditions
- Unfavourable machining conditions

TN**	L	I.C	S	d
16 04	16.5	9.525	4.76	3.81
22 04	22	12.7	4.76	5.16

Turning inserts

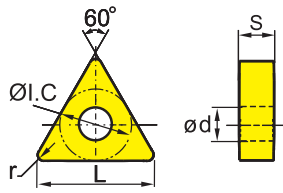

TN** negative insert				HC ¹ (CVD)								HC ¹ (PVD)			HT	HC ²	HW											
ISO	r	a _p	f	YBC103	YB6315	YBC152	YBC203	YBC252	YBC352	YBM153	YBM253	YBD102	YB7315	YBD152	YBD152C	YBG101	YBG102	YBG105	YBG205	YB9320	YPD201	YBS103	YNG151	YNT251	YNG151C	YD101	YD201	
WG	TNMX160408-WG	0.8	0.5-5.0	0.15-0.70	●	●	●	●	●	●	●	●	●	●	●	●	●	●	●	●	●	●	●	●	●			
	TNMX160412-WG	1.2	0.8-6.0	0.20-0.75	○																							
Wiper																												
ADF	TNMG160404-ADF	0.4	0.5-5.0	0.05-0.30	●																							
	TNMG160408-ADF	0.8	0.5-5.0	0.1-0.4	●														○									
	TNMG160412-ADF	1.2	0.5-5.0	0.2-0.5	●																							
Finishing																												
DF	TNMG160404-DF	0.4	0.15-2.00	0.08-0.25	●	●																						
	TNMG160408-DF	0.8	0.15-2.00	0.1-0.3	●	●																						
	TNMG160412-DF	1.2	0.35-1.50	0.15-0.50	●	●																						
	TNMG220408-DF	0.8	0.3-1.5	0.1-0.4	●	●																						
	TNMG220412-DF	1.2	0.35-1.50	0.15-0.50	●																							

● Ex stock ○ On demand
 YBC152F, YBC252F, YBM153F, YBM253F available

HC¹ Coated carbide
 HT Uncoated cermet
 HC² Coated cermet
 HW Uncoated carbide

Tool holder						
DTGNR/L	PTFNR/L	PTTNR/L	PTGNR/L	MTGNR/L	MTJNR/L	MTJNR/L
Kr: 91°	Kr: 91°	Kr: 60°	Kr: 90°	Kr: 90°	Kr: 93°	Kr: 93°
A233	A247	A248	A249	A260	A261	A262
MTFNR/L	S***-PTFNR/L					
Kr: 91°	Kr: 90°					
A263	A330					

General turning Negative inserts

A

Turning

- Ideal machining conditions
- ⊗ Normal machining conditions
- ⊗ Unfavourable machining conditions

TNMG	L	I.C	S	d
16 04	16.5	9.525	4.76	3.81

Turning inserts

TN** negative insert				HC ¹ (CVD)								HC ¹ (PVD)		HT	HC ²	HW												
	P	●●●●●	⊗⊗⊗									●●	⊗	●														
	M			●	⊗							●●	⊗	●														
	K								●●●●																			
	N										●●				●●	⊗												
	S										●●	⊗			●●	⊗												
	H																											
ISO	r	a _p	f	YBC103	YB6315	YBC152	YBC203	YBC252	YBC352	YBM153	YBM253	YBD102	YB7315	YBD152	YBD152C	YBG101	YBG102	YBG105	YBG205	YB9320	YPD201	YBS103	YNG151	YNT251	YNG151C	YD101	YD201	
SF	TNMG160404-SF	0.4	0.05-1.00	0.05-0.30																				○	●			
	TNMG160408-SF	0.8	0.05-1.00	0.05-0.40																					○	●		
Finishing																												

● Ex stock ○ On demand

HC¹ Coated carbide
 HT Uncoated cermet
 HC² Coated cermet
 HW Uncoated carbide

B

Milling

C

Drilling

D

Technical Information

E

Index

Tool holder						
DTGNR/L Kr: 91°	PTFNR/L Kr: 91°	PTTNR/L Kr: 60°	PTGNR/L Kr: 90°	MTGNR/L Kr: 90°	MTJNR/L Kr: 93°	MTJNR/L Kr: 93°
A233	A247	A248	A249	A260	A261	A262
MTFNR/L Kr: 91°	S***-PTFNR/L Kr: 90°					
A263	A330					

System code > A48

Grade selection > A42

Technical info > A501

Cutting data > A366

TNMG	L	I.C	S	d
11 03	11	6.35	3.18	2.26
16 04	16.5	9.525	4.76	3.81
22 04	22	12.7	4.76	5.16

- Ideal machining conditions
- ⊗ Normal machining conditions
- ⊗ Unfavourable machining conditions

Turning inserts

TN** negative insert				HC ¹ (CVD)								HC ¹ (PVD)			HT	HC ²	HW													
	P	M	K	N	S	H																								
	ISO	r	a _p	f	YBC103	YB6315	YBC152	YBC203	YBC252	YBC352	YBM153	YBM253	YBD102	YB7315	YBD152	YBD152C	YBG101	YBG102	YBG105	YBG205	YB9320	YPD201	YBS103	YNG151	YNT251	YNG151C	YD101	YD201		
		TNMG110304-EF	0.4	0.1-1.0	0.05-0.20															●										
		TNMG110308-EF	0.8	0.1-1.0	0.05-0.40																●									
		TNMG160404-EF	0.4	0.1-1.5	0.05-0.30							●									●									
		TNMG160408-EF	0.8	0.1-1.5	0.1-0.4							●									●									
TNMG160412-EF		1.2	0.2-2.5	0.15-0.40							○									●										
TNMG220404-EF		0.4	0.5-2.5	0.05-0.25							○									●										
TNMG220408-EF		0.8	0.5-2.5	0.1-0.4							○									●										

● Ex stock ○ On demand
 YBC152F, YBC252F, YBM153F, YBM253F available

HC¹ Coated carbide
 HT Uncoated cermet
 HC² Coated cermet
 HW Uncoated carbide

Tool holder						
DTGNR/L	PTFNR/L	PTTNR/L	PTGNR/L	MTGNR/L	MTJNR/L	MTJNR/L
Kr: 91°	Kr: 91°	Kr: 60°	Kr: 90°	Kr: 90°	Kr: 93°	Kr: 93°
A233	A247	A248	A249	A260	A261	A262
MTFNR/L	S***-PTFNR/L					
Kr: 91°	Kr: 90°					
A263	A330					

System code > A48

Grade selection > A42

Technical info > A501

Cutting data > A366



A
Turning

 B

 C
Milling

 D
Drilling

 E
Technical Information

 Index

General turning Negative inserts

A

Turning

- Ideal machining conditions
- ⊗ Normal machining conditions
- ⊗ Unfavourable machining conditions

TNMG	L	I.C	S	d
16 04	16,5	9.525	4.76	3.81
22 04	22	12.7	4.76	5.16

Turning inserts

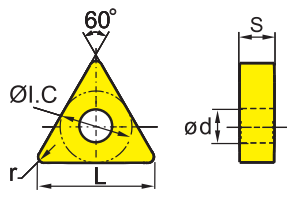

TN** negative insert				HC ¹ (CVD)								HC ¹ (PVD)		HT	HC ²	HW														
				P	M	K	N	S	H																					
	ISO	r	a _p	f	YBC103	YB6315	YBC152	YBC203	YBC252	YBC352	YBM153	YBM253	YBD102	YB7315	YBD152	YBD152C	YBG101	YBG102	YBG105	YBG205	YB9320	YPD201	YBS103	YNG151	YNT251	YNG151C	YD101	YD201		
FM 	TNMG160404L-FM	0.4	0.5-3.0	0.1-0.3						●										●										
	TNMG160404R-FM	0.4	0.5-3.0	0.1-0.3																●										
	TNMG160408L-FM	0.8	0.5-3.0	0.15-0.50			○													●										
	TNMG160408R-FM	0.8	0.5-3.0	0.15-0.50			●		●											●										
Finishing																														
XM 	TNMG160404-XM	0.4	1-5.6	0.2-0.4	●		○																							
	TNMG160408-XM	0.8	1-5.6	0.2-0.4	●			●																						
	TNMG160412-XM	1.2	1-5.6	0.2-0.6	●			●																						
	TNMG160416-XM	1.6	1-5.6	0.2-0.65	○			●																						
	TNMG220408-XM	0.8	1-7.7	0.2-0.4	●			●																						
	TNMG220412-XM	1.2	1-7.7	0.2-0.6	●			●																						
TNMG220416-XM	1.6	1-7.7	0.2-0.65	○			●																							

● Ex stock ○ On demand
 YBC152F, YBC252F, YBM153F, YBM253F available

HC¹ Coated carbide
 HT Uncoated cermet
 HC² Coated cermet
 HW Uncoated carbide

B

Milling

C

Drilling

D

Technical Information

E

Index

Tool holder						
DTGNR/L	PTFNR/L	PTTNR/L	PTGNR/L	MTGNR/L	MTJNR/L	MTJNR/L
Kr: 91°	Kr: 91°	Kr: 60°	Kr: 90°	Kr: 90°	Kr: 93°	Kr: 93°
A233	A247	A248	A249	A260	A261	A262
MTFNR/L	S***-PTFNR/L					
Kr: 91°	Kr: 90°					
A263	A330					





TNMG	L	I.C	S	d
11 03	11	6.35	3.18	2.26
16 04	16.5	9.525	4.76	3.81
22 04	22	12.7	4.76	5.16

- Ideal machining conditions
- ⊗ Normal machining conditions
- ⊗ Unfavourable machining conditions

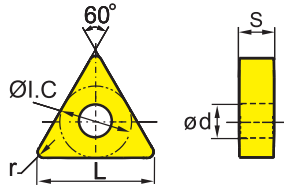
Turning inserts





TN** negative insert				HC ¹ (CVD)								HC ¹ (PVD)			HT	HC ²	HW															
				P	M	K	N	S	H																							
ISO				r	a _p	f	YBC103	YB6315	YBC152	YBC203	YBC252	YBC352	YBM153	YBM253	YBD102	YB7315	YBD152	YBD152C	YBG101	YBG102	YBG105	YBG205	YB9320	YPD201	YBS103	YNG151	YNT251	YNG151C	YD101	YD201		
DM  Medium Cut	TNMG110308-DM	0.8	0.3-3.0	0.1-0.4		○	●																									
	TNMG160404-DM	0.4	0.4-5.0	0.1-0.3		●	●		●																							
	TNMG160408-DM	0.8	0.5-5.0	0.15-0.50		●	●		○																							
	TNMG160412-DM	1.2	0.8-5.0	0.18-0.60		●	●																									
	TNMG220404-DM	0.4	0.4-6.6	0.1-0.3		●	●																									
	TNMG220408-DM	0.8	0.5-6.6	0.15-0.50		●	●																									
	TNMG220412-DM	1.2	0.8-6.6	0.18-0.60		●	●																									
TNMG220416-DM	1.6	1.0-6.6	0.23-0.65		●	●																										
PM  Medium Cut	TNMG110304-PM	0.4	0.4-3.0	0.1-0.3			●																									
	TNMG110308-PM	0.8	0.4-3.0	0.15-0.40			●																									
	TNMG160404-PM	0.4	0.4-5.0	0.1-0.3		●	●							●	●																	
	TNMG160408-PM	0.8	0.5-5.0	0.15-0.50		●	●							●	●																	
	TNMG160412-PM	1.2	0.8-5.0	0.18-0.60		●	●							○	○																	
	TNMG220408-PM	0.8	0.5-6.6	0.15-0.50		○	●							●	●																	
	TNMG220412-PM	1.2	0.8-6.6	0.18-0.60		○	●							●	●																	
TNMG220416-PM	1.6	1.0-6.6	0.23-0.65			○						○																				

● Ex stock ○ On demand
YBC152F, YBC252F, YBM153F, YBM253F available

HC¹ Coated carbide
HT Uncoated cermet
HC² Coated cermet
HW Uncoated carbide

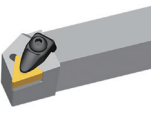
Tool holder

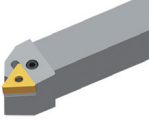
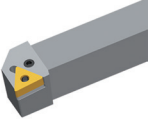
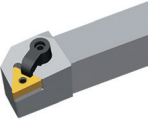
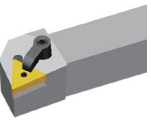
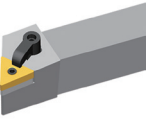
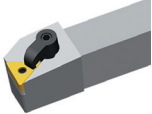
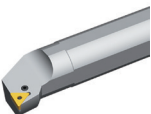
DTGNR/L	PTFNR/L	PTTNR/L	PTGNR/L	MTGNR/L	MTJNR/L	MTJNR/L
Kr: 91°	Kr: 91°	Kr: 60°	Kr: 90°	Kr: 90°	Kr: 93°	Kr: 93°
						
A233	A247	A248	A249	A260	A261	A262
MTFNR/L	S***-PTFNR/L					
Kr: 91°	Kr: 90°					
						
A263	A330					

System code > A48

Grade selection > A42

Technical info > A501

Cutting data > A366



A

Turning

B

Milling

C

Drilling

D

Technical Information

E

Index

A

Turning

- Ideal machining conditions
- ⊗ Normal machining conditions
- ⊗ Unfavourable machining conditions

TNMG	L	I.C	S	d
16 04	16.5	9.525	4.76	3.81

Turning inserts

TN** negative insert					HC ¹ (CVD)										HC ¹ (PVD)		HT	HC ²	HW											
					P	●	●	●	⊗	⊗	⊗									●	⊗	●								
					M						●	⊗	●	●	⊗	⊗	⊗			●	⊗	●								
					K																									
					N												●	●						●	⊗					
					S																				●	⊗				
					H																									
ISO	r	a _p	f		YBC103	YB6315	YBC152	YBC203	YBC252	YBC352	YBM153	YBM253	YBD102	YB7315	YBD152	YBD152C	YBG101	YBG102	YBG105	YBG205	YB9320	YPD201	YBS103	YNG151	YNT251	YNG151C	YD101	YD201		
ZM Medium Cut	TNMG160404-ZM	0.4	0.5-5.0	0.08-0.30	●																									
	TNMG160408-ZM	0.8	0.5-5.0	0.1-0.4	●																									
	TNMG160412-ZM	1.2	0.5-5.0	0.1-0.6	●																									
SNR Roughing	TNMG160408-SNR	0.8	1-5.6	0.1-0.5																				●						

● Ex stock ○ On demand

HC¹ Coated carbide
 HT Uncoated cermet
 HC² Coated cermet
 HW Uncoated carbide

B

Milling

C

Drilling

D

Technical Information

E

Index

Tool holder						
DTGNR/L	PTFNR/L	PTTNR/L	PTGNR/L	MTGNR/L	MTJNR/L	MTJNR/L
Kr: 91°	Kr: 91°	Kr: 60°	Kr: 90°	Kr: 90°	Kr: 93°	Kr: 93°
A233	A247	A248	A249	A260	A261	A262
MTFNR/L	S***-PTFNR/L					
Kr: 91°	Kr: 90°					
A263	A330					



- Ideal machining conditions
- Normal machining conditions
- Unfavourable machining conditions

TNMG	L	I.C	S	d
16 04	16.5	9.525	4.76	3.81
22 04	22	12.7	4.76	5.16

Turning inserts

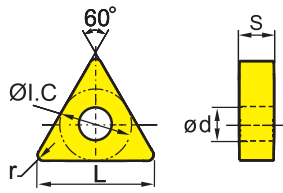

TN** negative insert				HC ¹ (CVD)								HC ¹ (PVD)			HT	HC ²	HW													
				P	M	K	N	S	H																					
ISO				r	a _p	f	YBC103	YB6315	YBC152	YBC203	YBC252	YBC352	YBM153	YBM253	YBD102	YB7315	YBD152	YBD152C	YBG101	YBG102	YBG105	YBG205	YB9320	YPD201	YBS103	YNG151	YNT251	YNG151C	YD101	YD201
EG 	TNMG160404-EG	0.4	0.5-4.0	0.1-0.3																										
	TNMG160408-EG	0.8	0.5-4.0	0.1-0.4																										
	TNMG160412-EG	1.2	0.5-4.0	0.15-0.50																										
EM 	TNMG160404-EM	0.4	0.5-4.8	0.05-0.30									●	○																
	TNMG160408-EM	0.8	0.5-4.8	0.10-0.45									●	●																
	TNMG160412-EM	1.2	0.5-4.8	0.1-0.6									●	●																
	TNMG220408-EM	0.8	0.5-6.6	0.10-0.45									●	●																
	TNMG220412-EM	1.2	0.5-6.6	0.1-0.6									○	●																
TC 	TNMG160404-TC	0.4	0.5-3.0	0.05-0.20											●		●													
	TNMG160408-TC	0.8	0.5-3.0	0.08-0.25											●		●													
	TNMG160412-TC	1.2	1-3	0.1-0.3											●		●													
	TNMG220412-TC	1.2	1-6	0.15-0.40											●		●													
	TNMG220416-TC	1.6	1-6	0.2-0.5											●		●													

● Ex stock ○ On demand
YBC152F, YBC252F, YBM153F, YBM253F available

HC¹ Coated carbide
HT Uncoated cermet
HC² Coated cermet
HW Uncoated carbide

Tool holder						
DTGNR/L	PTFNR/L	PTTNR/L	PTGNR/L	MTGNR/L	MTJNR/L	MTJNR/L
Kr: 91°	Kr: 91°	Kr: 60°	Kr: 90°	Kr: 90°	Kr: 93°	Kr: 93°
A233	A247	A248	A249	A260	A261	A262
MTFNR/L	S***-PTFNR/L					
Kr: 91°	Kr: 90°					
A263	A330					



A Turning
B Milling
C Drilling
D Technical Information
E Index

A

Turning

B

Milling

C

Drilling

D

Technical Information

E

Index

- Ideal machining conditions
- ⊗ Normal machining conditions
- ⊗ Unfavourable machining conditions

TNMG	L	I.C	S	d
16 04	16.5	9.525	4.76	3.81
22 04	22	12.7	4.76	5.16
27 06	27.5	15.875	6.35	6.35

Turning inserts

TN** negative insert				HC ¹ (CVD)								HC ¹ (PVD)			HT	HC ²	HW																
	P	M	K	N	S	H																											
	ISO				r	a _p	f	YBC103	YB6315	YBC152	YBC203	YBC252	YBC352	YBM153	YBM253	YBD102	YB7315	YBD152	YBD152C	YBG101	YBG102	YBG105	YBG205	YB9320	YPD201	YBS103	YNG151	YNT251	YNG151C	YD101	YD201		
		TNMG160408-DR	0.8	0.7-6.0	0.20-0.55	●	●									●	●																
		TNMG160412-DR	1.2	1-6	0.25-0.65	●	●									○																	
		TNMG220408-DR	0.8	0.7-7.0	0.20-0.55		●												○														
		TNMG220412-DR	1.2	1-7	0.25-0.65	○	●																										
TNMG220416-DR		1.6	1.5-7.0	0.32-0.75		●										○																	
TNMG270608-DR		0.8	1.5-12.0	0.35-0.55																													
TNMG270612-DR		1.2	2-12	0.35-0.75								○																					



● Ex stock ○ On demand
 YBC152F, YBC252F, YBM153F, YBM253F available

- HC¹ Coated carbide
- HT Uncoated cermet
- HC² Coated cermet
- HW Uncoated carbide





Tool holder						
DTGNR/L	PTFNR/L	PTTNR/L	PTGNR/L	MTGNR/L	MTJNR/L	MTJNR/L
Kr: 91°	Kr: 91°	Kr: 60°	Kr: 90°	Kr: 90°	Kr: 93°	Kr: 93°
A233	A247	A248	A249	A260	A261	A262
MTFNR/L	S***-PTFNR/L					
Kr: 91°	Kr: 90°					
A263	A330					

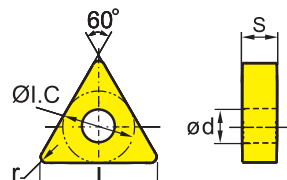

TN**	L	I.C	S	d
16 04	16.5	9.525	4.76	3.81
22 04	22	12.7	4.76	5.16
27 06	27.5	15.875	6.35	5.16

-  Ideal machining conditions
-  Normal machining conditions
-  Unfavourable machining conditions

Turning inserts

TN** negative insert				HC ¹ (CVD)								HC ¹ (PVD)			HT	HC ²	HW										
				P	M	K	N	S	H																		
																											
ISO	r	a _p	f	YBC103	YB6315	YBC152	YBC203	YBC252	YBC352	YBM153	YBM253	YBD102	YBD152	YBD152C	YBG101	YBG102	YBG105	YBG205	YB9320	YPD201	YBS103	YNG151	YNT251	YNG151C	YD101	YD201	
DR  Roughing	TNMM160408-DR	0.8	0.7-6.0	0.20-0.55	○	●																					
	TNMM160412-DR	1.2	1-6	0.25-0.70	○	●																					
	TNMM220408-DR	0.8	0.7-8.0	0.20-0.55	○	○																					
	TNMM220412-DR	1.2	1-8	0.25-0.70																							
	TNMM220416-DR	1.6	1.5-8.0	0.32-0.90																							
	TNMM270612-DR	1.2	2.5-11.0	0.25-0.70																							
	TNMM270616-DR	1.6	2.5-11.0	0.3-0.9																							
ER  Roughing	TNMG160408-ER	0.8	2.0-5.6	0.15-0.55																							
	TNMG160412-ER	1.2	2.0-5.6	0.15-0.60																							
	TNMG220408-ER	0.8	2.0-7.7	0.15-0.55																							
	TNMG220412-ER	1.2	2.0-7.7	0.15-0.60																							
LR  Roughing	TNMM160408-LR	0.8	1-5	0.1-0.5	●	●	●																				
	TNMM160412-LR	1.2	1.5-6.0	0.1-0.6	○	○	○																				

● Ex stock ○ On demand
 YBC152F, YBC252F, YBM153F, YBM253F available

HC¹ Coated carbide
 HT Uncoated cermet
 HC² Coated cermet
 HW Uncoated carbide

A

Turning

B

Milling

C

Drilling

D

Technical Information

E

Index

A

Turning

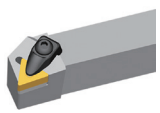
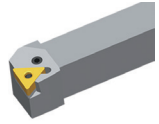
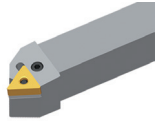
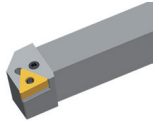
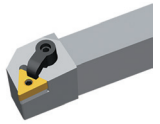
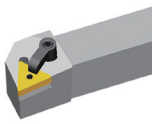
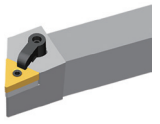
Tool holder						
DTG NR/L Kr: 91°	PTF NR/L Kr: 91°	PTT NR/L Kr: 60°	PTG NR/L Kr: 90°	MTG NR/L Kr: 90°	MTJ NR/L Kr: 93°	MTJ NR/L Kr: 93°
						
A233	A247	A248	A249	A260	A261	A262

B

Milling

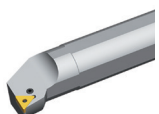
MTF NR/L Kr: 91°	S***-PTF NR/L Kr: 90°
	
A263	A330

C

Drilling

D

Technical Information

E

Index

System code > A48

Grade selection > A42

Technical info > A501

Cutting data > A366

- Ideal machining conditions
- Normal machining conditions
- Unfavourable machining conditions

TNMM	L	I.C	S	d
22 04	22	12.7	4.76	5.16
27 06	27.5	15.875	6.35	6.35

Turning inserts

TN** negative insert				HC ¹ (CVD)								HC ¹ (PVD)			HT	HC ²	HW											
				P	●	●	●	●	●	●	●	●	●	●	●	●	●											
				M						●	●	●	●	●	●	●	●	●										
				K									●	●	●	●	●	●										
				N									●	●					●	●								
				S										●	●	●	●	●		●	●							
				H																								
ISO	r	a _p	f	YBC103	YB6315	YBC152	YBC203	YBC252	YBC352	YBM153	YBM253	YBD102	YB7315	YBD152	YBD152C	YBG101	YBG102	YBG105	YBG205	YB9320	YPD201	YBS103	YNG151	YNT251	YNG151C	YD101	YD201	
HDR	TNMM220412-HDR	1.2	2-9	0.25-0.80		○																						
 Heavy Turning	TNMM220416-HDR	1.6	2-9	0.35-1.00					○																			
	TNMM270616-HDR	1.6	2-6	0.35-1.00					●																			
	TNMM270624-HDR	2.4	2-7	0.4-1.2					●		○																	

● Ex stock ○ On demand
 YBC152F, YBC252F, YBM153F, YBM253F available

HC¹ Coated carbide
 HT Uncoated cermet
 HC² Coated cermet
 HW Uncoated carbide

Tool holder						
PTFNR/L	PTTNR/L	PTGNR/L	MTGNR/L	MTJNR/L	MTJNR/L	MTFNR/L
Kr: 91°	Kr: 60°	Kr: 90°	Kr: 90°	Kr: 93°	Kr: 93°	Kr: 91°
A247	A248	A249	A260	A261	A262	A263

A

Turning

B

Milling

C

Drilling

D

Technical Information

E

Index

TNMG	L	I.C	S	d
16 04	16.5	9.525	4.76	3.81
22 04	22	12.7	4.76	5.16
27 06	27.5	15.875	6.35	6.35
33 09	33	19.05	9.525	7.94

- Ideal machining conditions
- ⊗ Normal machining conditions
- ⊗ Unfavourable machining conditions

Turning inserts

TN** negative insert					HC ¹ (CVD)								HC ¹ (PVD)		HT	HC ²	HW													
					P	●	●	●	⊗	⊗	⊗	●	●	●	●	●	●	●	●											
					M	●	●	●	●	●	●	●	●	●	●	●	●	●	●	●	●									
					K	●	●	●	●	●	●	●	●	●	●	●	●	●	●											
					N	●	●	●	●	●	●	●	●	●	●	●	●	●	●	●	●									
					S	●	●	●	●	●	●	●	●	●	●	●	●	●	●											
					H	●	●	●	●	●	●	●	●	●	●	●	●	●	●	●	●									
ISO		r	a _p	f	YBC103	YB6315	YBC152	YBC203	YBC252	YBC352	YBM153	YBM253	YBD102	YB7315	YBD152	YBD152C	YBG101	YBG102	YBG105	YBG205	YB9320	YPD201	YBS103	YNG151	YNT251	YNG151C	YD101	YD201		
 Basic Medium Cut	TNMG160404	0.4	0.2-4.0	0.05-0.20						○																				
	TNMG160408	0.8	0.2-4.0	0.08-0.30		●	●																							
	TNMG160412	1.2	0.2-4.0	0.1-0.4		●																								
	TNMG220404	0.4	0.2-6.0	0.05-0.20							○																			
	TNMG220408	0.8	0.2-6.0	0.1-0.3																										
	TNMG220416	1.6	0.2-6.0	0.1-0.5							○																			
	TNMG270612	1.2	0.2-9.0	0.1-0.5							○																			
	TNMG270616	1.6	0.2-9.0	0.1-0.5							○																			
	TNMG330916	1.6	0.2-11.0	0.1-0.5							○																			
	TNMG330924	2.4	0.2-11.0	0.1-0.7							○																			

● Ex stock ○ On demand
 YBC152F, YBC252F, YBM153F, YBM253F available

HC¹ Coated carbide
 HT Uncoated cermet
 HC² Coated cermet
 HW Uncoated carbide

Tool holder						
DTGNR/L	PTFNR/L	PTTNR/L	PTGNR/L	MTGNR/L	MTJNR/L	MTJNR/L
Kr: 91°	Kr: 91°	Kr: 60°	Kr: 90°	Kr: 90°	Kr: 93°	Kr: 93°
A233	A247	A248	A249	A260	A261	A262
MTFNR/L	S***-PTFNR/L					
Kr: 91°	Kr: 90°					
A263	A330					

System code > A48

Grade selection > A42

Technical info > A501

Cutting data > A366

TN**	L	I.C	S	d
16 04	16.5	9.525	4.76	3.81
22 04	22	12.7	4.76	5.16
27 06	27.5	15.875	6.35	6.35

- Ideal machining conditions
- Normal machining conditions
- Unfavourable machining conditions

Turning inserts

TN** negative insert				HC ¹ (CVD)								HC ¹ (PVD)		HT	HC ²	HW														
				P	●●●●●●●●								●●●●	●●●●	●●															
				M				●●●●						●●●●	●●●●	●●														
				K							●●●●																			
				N									●●					●●	●●											
				S										●●●●				●●	●●											
				H																										
ISO	r	a _p	f	YBC103	YB6315	YBC152	YBC203	YBC252	YBC352	YBM153	YBM253	YBD102	YB7315	YBD152	YBD152C	YBG101	YBG102	YBG105	YBG205	YB9320	YPD201	YBS103	YNG151	YNT251	YNG151C	YD101	YD201			
	TNMA160404	0.4	0.2-4.0	0.05-0.20								○	●																	
	TNMA160408	0.8	0.2-4.0	0.08-0.30								●	●	●																
	TNMA160412	1.2	0.2-4.0	0.1-0.4									○	●																
	TNMA160416	1.6	0.5-4.0	0.05-0.50									○	○																
	TNMA220404	0.4	0.2-6.0	0.05-0.20											●															
	TNMA220408	0.8	0.2-6.0	0.1-0.3									●		●															
	TNMA220412	1.2	0.2-6.0	0.1-0.4											●	●														
	TNMA220416	1.6	0.2-6.0	0.1-0.5												○														
	TNMM160404	0.4	0.2-7.0	0.05-0.60				○																						
	TNMM160408	0.8	0.5-7.0	0.05-0.60				○																						
	TNMM220408	0.8	0.5-7.0	0.05-0.60				○																						
	TNMM220412	1.2	1-7	0.1-0.6																										
	TNMM220416	1.6	0.5-7.0	0.05-0.60					○																					
	TNMM270616	1.6	0.5-6.5	0.05-0.70					○																					

● Ex stock ○ On demand
 YBC152F, YBC252F, YBM153F, YBM253F available

HC¹ Coated carbide
 HT Uncoated cermet
 HC² Coated cermet
 HW Uncoated carbide

Tool holder						
DTGNR/L Kr: 91°	PTFNR/L Kr: 91°	PTTNR/L Kr: 60°	PTGNR/L Kr: 90°	MTGNR/L Kr: 90°	MTJNR/L Kr: 93°	MTJNR/L Kr: 93°
A233	A247	A248	A249	A260	A261	A262
MTFNR/L Kr: 91°	S***-PTFNR/L Kr: 90°					
A263	A330					



A

Turning

B

Milling

C

Drilling

D

Technical Information

E

Index

General turning Negative inserts

A

Turning

- Ideal machining conditions
- ⊗ Normal machining conditions
- ⊛ Unfavourable machining conditions

VN**	L	I.C	S	d
16 04	16.6	9.525	4.76	3.81

Turning inserts

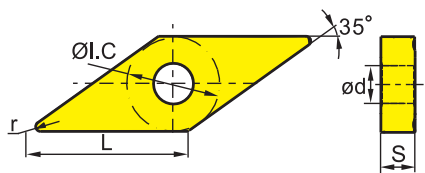

VN** negative insert					HC ¹ (CVD)								HC ¹ (PVD)			HT	HC ²	HW															
					P	●●●●●			⊗⊗		●●●●●			●	●																		
					M	●●			●●●●●			●	●																				
					K	●●●●●																											
					N				●●				●●																				
					S				●●●●●				●●																				
					H																												
ISO					r	a _p	f	YBC103	YB6315	YBC152	YBC203	YBC252	YBC352	YBM153	YBM253	YBD102	YB7315	YBD152	YBD152C	YBG101	YBG102	YBG105	YBG205	YB9320	YPD201	YBS103	YNG151	YNT251	YNG151C	YD101	YD201		
ADF	VNMG160404-ADF	0.4	0.5-2.5	0.1-0.3			●																										
	VNMG160408-ADF	0.8	0.5-2.5	0.1-0.5			●																										
DF	VNMG160404-DF	0.4	0.25-1.50	0.07-0.30				○	●																								
	VNMG160408-DF	0.8	0.3-1.5	0.1-0.4				●	●																								
EF	VNMG160404-EF	0.4	0.1-1.5	0.05-0.25										●																			
	VNMG160408-EF	0.8	0.2-2.5	0.08-0.35										●																			
	VNMG160412-EF	1.2	0.2-2.5	0.10-0.45										○																			
NF	VNEG160404-NF	0.4	0.2-4.0	0.05-0.30																		●										○	
	VNEG160408-NF	0.8	0.2-4.0	0.05-0.50																		●										○	

● Ex stock ○ On demand
 YBC152F, YBC252F, YBM153F, YBM253F available

HC¹ Coated carbide
 HT Uncoated cermet
 HC² Coated cermet
 HW Uncoated carbide

B

Milling

C

Drilling

D

Technical Information

E

Index

Tool holder			
DVVNN	DVJNR/L	MVVNN	MVJNR/L
Kr: 72°30'	Kr: 93°	Kr: 72°30'	Kr: 93°
A234	A235	A264	A265



- Ideal machining conditions
- ⊗ Normal machining conditions
- ⊗ Unfavourable machining conditions

VN**	L	I.C	S	d
16 04	16.6	9.525	4.76	3.81

Turning inserts

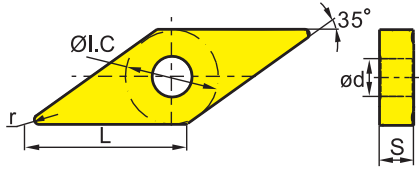

VN** negative insert				HC ¹ (CVD)							HC ¹ (PVD)			HT	HC ²	HW											
				P	M	K	N	S	H																		
ISO	r	a _p	f	YBC103	YB6315	YBC152	YBC203	YBC252	YBC352	YBM153	YBM253	YBD102	YB7315	YBD152	YBD152C	YBG101	YBG102	YBG105	YBG205	YB9320	YPD201	YBS103	YNG151	YNT251	YNG151C	YD101	YD201
NGF	VNEG160408-NGF	0.8	0.2-3.0	0.1-0.3														●									
	VNEG160412-NGF	1.2	0.2-3.0	0.1-0.5														○									
Finishing																											
SF	VNMG160404-SF	0.4	0.05-3.00	0.05-0.20																					●		
	VNMG160408-SF	0.8	0.05-3.00	0.05-0.35																					○		
Finishing																											

● Ex stock ○ On demand

HC¹ Coated carbide
 HT Uncoated cermet
 HC² Coated cermet
 HW Uncoated carbide

Tool holder

DVVNN	DVJNR/L	MVVNN	MVJNR/L
Kr: 72°30'	Kr: 93°	Kr: 72°30'	Kr: 93°
A234	A235	A264	A265

System code > A48

Grade selection > A42

Technical info > A501

Cutting data > A366





A

Turning

- Ideal machining conditions
- ⊗ Normal machining conditions
- ⊗ Unfavourable machining conditions

VNMG	L	I.C	S	d
16 04	16.6	9.525	4.76	3.81

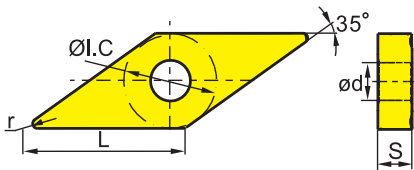
Turning inserts

VN** negative insert				HC ¹ (CVD)										HC ¹ (PVD)		HT	HC ²	HW									
				P	●	●	●	●	●	●	●	●	●	●	●	●	●	●	●	●	●						
				M	●	●	●	●	●	●	●	●	●	●	●	●	●	●	●	●	●	●	●				
				K	●	●	●	●	●	●	●	●	●	●	●	●	●	●	●	●	●	●	●	●			
				N	●	●	●	●	●	●	●	●	●	●	●	●	●	●	●	●	●	●	●	●			
				S	●	●	●	●	●	●	●	●	●	●	●	●	●	●	●	●	●	●	●	●			
				H	●	●	●	●	●	●	●	●	●	●	●	●	●	●	●	●	●	●	●	●			
ISO	r	a _p	f	YBC103	YB6315	YBC152	YBC203	YBC252	YBC352	YBM153	YBM253	YBD102	YB7315	YBD152	YBD152C	YBG101	YBG102	YBG105	YBG205	YB9320	YPD201	YBS103	YNG151	YNT251	YNG151C	YD101	YD201
XF 	VNMG160404-XF	0.4	0.5-2.5	0.1-0.25	●																						
	VNMG160408-XF	0.8	0.5-2.5	0.1-0.30	●																						
	VNMG160412-XF	1.2	0.5-2.5	0.1-0.35	●																						
Finishing																											
XM 	VNMG160404-XM	0.4	1-5.6	0.2-0.4	●					○																	
	VNMG160408-XM	0.8	1-5.6	0.2-0.4	●					●																	
	VNMG160412-XM	1.2	1-5.6	0.2-0.6	●					●																	
	VNMG160416-XM	1.6	1-5.6	0.2-0.65	○					○																	

● Ex stock ○ On demand

HC¹ Coated carbide
 HT Uncoated cermet
 HC² Coated cermet
 HW Uncoated carbide

B

Milling

C



Drilling

D

Technical Information

E

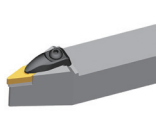
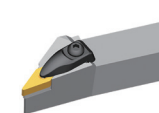
Index

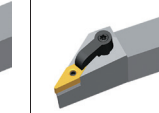
Tool holder			
DVNN	DVJNR/L	MVNN	MVJNR/L
Kr: 72°30'	Kr: 93°	Kr: 72°30'	Kr: 93°
			
A234	A235	A264	A265

System code > A48

Grade selection > A42

Technical info > A501

Cutting data > A366

- Ideal machining conditions
- Normal machining conditions
- Unfavourable machining conditions

VNMG	L	I.C	S	d
16 04	16.6	9.525	4.76	3.81

Turning inserts

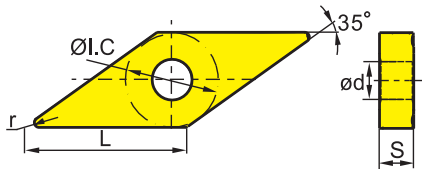

VN** negative insert				HC ¹ (CVD)								HC ¹ (PVD)				HT	HC ²	HW		
				P	M	K	N	S	H											
Basic	VNMG160404	0.4	0.2-6.0	0.05-0.60	○															
	VNMG160408	0.8	0.2-6.0	0.08-0.60	○															
Medium Cut																				
DM	VNMG160408-DM	0.8	0.5-4.0	0.15-0.50	●	●														
	VNMG160412-DM	1.2	0.8-4.0	0.18-0.60	●	●														
Medium Cut																				
EM	VNMG160404-EM	0.4	0.2-3.0	0.05-0.30		●														
	VNMG160408-EM	0.8	0.5-4.0	0.10-0.45		●														
Medium Cut																				
NM	VNMG160412-NM	1.2	0.2-4.0	0.05-0.40																
Medium Cut																				

● Ex stock ○ On demand
 YBC152F, YBC252F, YBM153F, YBM253F available

HC¹ Coated carbide
 HT Uncoated cermet
 HC² Coated cermet
 HW Uncoated carbide

Tool holder			
DVVNN	DVJNR/L	MVVNN	MVJNR/L
Kr: 72°30'	Kr: 93°	Kr: 72°30'	Kr: 93°
A234	A235	A264	A265



A Turning
B Milling
C Drilling
D Technical Information
E Index

A

Turning

- Ideal machining conditions
- ⊗ Normal machining conditions
- ⊗ Unfavourable machining conditions

VNMG	L	I.C	S	d
16 04	16.6	9.525	4.76	3.81

Turning inserts

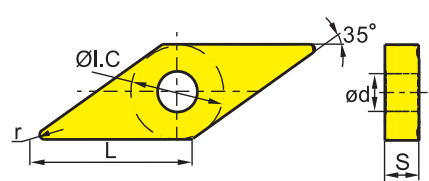

VN** negative insert					HC ¹ (CVD)								HC ¹ (PVD)			HT	HC ²	HW											
					P	●	●	●	⊗	⊗	⊗																		
					M				●	⊗		●	●	⊗	⊗														
					K																								
					N							●	●			●													
					S											●													
					H																								
	ISO	r	a _p	f	YBC103	YB6315	YBC152	YBC203	YBC252	YBC352	YBM153	YBM253	YBD102	YB7315	YBD152	YBD152C	YBG101	YBG102	YBG105	YBG205	YB9320	YPD201	YBS103	YNG151	YNT251	YNG151C	YD101	YD201	
PM 	VNMG160404-PM	0.4	0.4-4.0	0.13-0.40			●	●					●	○															
	VNMG160408-PM	0.8	0.5-4.0	0.15-0.50			●	●					●	●															
	VNMG160412-PM	1.2	0.8-4.0	0.18-0.60					●				●																
TC 	VNMG160404-TC	0.4	0.5-2.0	0.05-0.20											●	●													
	VNMG160408-TC	0.8	0.5-2.0	0.08-0.25											●	●													
	VNMG160412-TC	1.2	0.5-3.0	0.08-0.30											●	●													
ZM 	VNMG160404-ZM	0.4	0.5-3.0	0.08-0.30	○																								
	VNMG160408-ZM	0.8	0.5-3.0	0.1-0.4	●																								
SNR 	VNMG160408-SNR	0.8	0.2-2.0	0.1-0.4														●	○	●									
	VNMG160412-SNR	1.2	0.2-2.0	0.1-0.5															●	○	●								

● Ex stock ○ On demand
 YBC152F, YBC252F, YBM153F, YBM253F available

- HC¹ Coated carbide
- HT Uncoated cermet
- HC² Coated cermet
- HW Uncoated carbide

B

Milling

C

Drilling

D

Technical Information

E

Index

Tool holder			
DVVNN	DVJNR/L	MVVNN	MVJNR/L
Kr: 72°30'	Kr: 93°	Kr: 72°30'	Kr: 93°
A234	A235	A264	A265



WNMG	L	I.C	S	d
06 T3	6.5	9.525	3.97	3.81
06 04	6.5	9.525	4.76	3.81
08 04	8.7	12.7	4.76	5.16

- Ideal machining conditions
- ⊗ Normal machining conditions
- ⊗ Unfavourable machining conditions

Turning inserts

WN** negative insert				HC ¹ (CVD)								HC ¹ (PVD)			HT	HC ²	HW										
				P	M	K	N	S	H																		
ISO	r	a _p	f	YBC103	YB6315	YBC152	YBC203	YBC252	YBC352	YBM153	YBM253	YBD102	YB7315	YBD152	YBD152C	YBG101	YBG102	YBG105	YBG205	YB9320	YPD201	YBS103	YNG151	YNT251	YNG151C	YD101	YD201
ADF	WNMG080404-ADF	0.4	0.2-2.5	0.05-0.30	●															●			●				
	WNMG080408-ADF	0.8	0.5-2.5	0.05-0.40	●														○	●			●				
	WNMG080412-ADF	1.2	0.5-2.5	0.05-0.50	●															●							
Finishing																											
DF	WNMG060404-DF	0.4	0.15-2.00	0.08-0.25		●	●																				
	WNMG060408-DF	0.8	0.15-2.00	0.1-0.3		●	●																				
	WNMG080404-DF	0.4	0.15-2.00	0.08-0.25		●	●																				
Finishing	WNMG080408-DF	0.8	0.15-2.00	0.1-0.3		●	○																				
	WNMG080412-DF	1.2	0.2-2.5	0.10-0.35		●	●																				
SF	WNMG060404-SF	0.4	0.05-0.50	0.05-0.20																					●		
	WNMG060408-SF	0.8	0.05-0.50	0.05-0.35																					●		
	WNMG06T304-SF	0.4	0.05-0.50	0.05-0.20																					●		
	WNMG06T308-SF	0.8	0.05-0.50	0.05-0.35																					●		
Finishing	WNMG080404-SF	0.4	0.05-0.50	0.05-0.20																					●		
	WNMG080408-SF	0.8	0.05-0.50	0.05-0.35																					●		

● Ex stock ○ On demand
 YBC152F, YBC252F, YBM153F, YBM253F available

HC¹ Coated carbide
 HT Uncoated cermet
 HC² Coated cermet
 HW Uncoated carbide

Tool holder			
DWLNLR/L	PWLNLR/L	MWLNLR/L	S***-PWLNLR/L
Kr: 95°	Kr: 95°	Kr: 95°	Kr: 95°
A236	A251	A266	A332

System code > A48

Grade selection > A42

Technical info > A501

Cutting data > A366



General turning Negative inserts

A

Turning

B

Milling

C

Drilling

D

Technical Information





E

Index

- Ideal machining conditions
- ⊗ Normal machining conditions
- ⊗ Unfavourable machining conditions



WN**	L	I.C	S	d
06 T3	6.5	9.525	3.97	3.81
06 04	6.5	9.525	4.76	3.81
08 04	8.7	12.7	4.76	5.16

Turning inserts

WN** negative insert				HC ¹ (CVD)								HC ¹ (PVD)			HT	HC ²	HW												
ISO	r	a _p	f	YBC103	YB6315	YBC152	YBC203	YBC252	YBC352	YBM153	YBM253	YBD102	YB7315	YBD152	YBD152C	YBG101	YBG102	YBG105	YBG205	YB9320	YPD201	YBS103	YNG151	YNT251	YNG151C	YD101	YD201		
WG  Wiper	WNMG080408-WG	0.8	0.5-5.0	0.15-0.70	●	●																							
	WNMG080412-WG	1.2	0.8-6.0	0.20-0.75	●	○																							
EF  Finishing	WNMG060404-EF	0.4	0.1-1.5	0.05-0.30						○								●											
	WNMG060408-EF	0.8	0.1-1.5	0.1-0.4						○								●											
	WNMG06T308-EF	0.8	0.1-1.5	0.1-0.4														●											
	WNMG080404-EF	0.4	0.1-1.5	0.05-0.30						●								○	●										
	WNMG080408-EF	0.8	0.1-1.5	0.1-0.4						●									○	●									
NF  Finishing	WNEG080404-NF	0.4	0.2-3.0	0.05-0.30													○	●											
	WNEG080408-NF	0.8	0.2-2.5	0.05-0.30														●											
NF  Finishing	WNMG060408-NF	0.8	0.2-2.5	0.05-0.30														●											

● Ex stock ○ On demand
YBC152F, YBC252F, YBM153F, YBM253F available

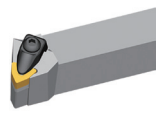
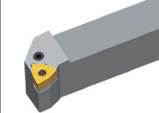
HC¹ Coated carbide
HT Uncoated cermet
HC² Coated cermet
HW Uncoated carbide

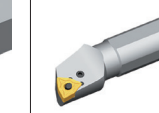
Tool holder			
DWLNRL	PWLNRL	MWLNRL	S***-PWLNRL
Kr: 95°	Kr: 95°	Kr: 95°	Kr: 95°
			
A236	A251	A266	A332



- Ideal machining conditions
- ⊗ Normal machining conditions
- ⊗ Unfavourable machining conditions

WNMG	L	I.C	S	d
06 04	6.5	9.525	4.76	3.81
08 04	8.7	12.7	4.76	5.16

Turning inserts

WN** negative insert					HC ¹ (CVD)								HC ¹ (PVD)				HT	HC ²	HW										
					P	●	●	●	●	●	⊗							●	⊗	●									
					M						●	⊗					●	●	●	●	●	●							
					K																								
					N												●	●						●	⊗				
					S																				●	⊗			
					H																								
ISO	r	a _p	f		YBC103	YB6315	YBC152	YBC203	YBC252	YBC352	YBM153	YBM253	YBD102	YB7315	YBD152	YBD152C	YBG101	YBG102	YBG105	YBG205	YB9320	YPD201	YBS103	YNG151	YNT251	YNG151C	YD101	YD201	
XF Finishing	WNMG060404-XF	0.4	0.5-2.0	0.1-0.25	●																								
	WNMG060408-XF	0.8	0.5-2.0	0.1-0.30	●																								
	WNMG080408-XF	0.8	0.5-2.5	0.1-0.30	●																								
	WNMG080412-XF	1.2	0.5-2.5	0.1-0.35	●																								
XM Medium Cut	WNMG060404-XM	0.4	1-2.1	0.2-0.4	●	○																							
	WNMG060408-XM	0.8	1-2.1	0.2-0.4	●	●																							
	WNMG060412-XM	1.2	1-2.1	0.2-0.6	●	●																							
	WNMG080404-XM	0.4	1-2.8	0.2-0.4	●	●																							
	WNMG080408-XM	0.8	1-2.8	0.2-0.4	●	●																							
	WNMG080412-XM	1.2	1-2.8	0.2-0.6	●	●																							
WNMG080416-XM	1.6	1-2.8	0.2-0.65	○	○																								

● Ex stock ○ On demand

HC¹ Coated carbide
 HT Uncoated cermet
 HC² Coated cermet
 HW Uncoated carbide

Tool holder			
DWLNR/L Kr: 95°	PWLNR/L Kr: 95°	MWLNR/L Kr: 95°	S***-PWLNR/L Kr: 95°
A236	A251	A266	A332

A

Turning

B

Milling

C

Drilling

D

Technical Information





E

Index

- Ideal machining conditions
- ⊗ Normal machining conditions
- ⊗ Unfavourable machining conditions

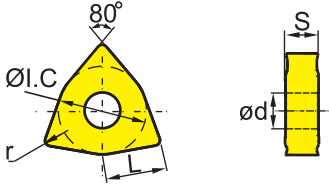

WNMG	L	I.C	S	d
06 T3	6.5	9.525	3.97	3.81
06 04	6.5	9.525	4.76	3.81
08 04	8.7	12.7	4.76	5.16

Turning inserts

WN** negative insert				HC ¹ (CVD)								HC ¹ (PVD)			HT	HC ²	HW													
	P	M	K	N	S	H																								
	ISO	r	a _p	f	YBC103	YB6315	YBC152	YBC203	YBC252	YBC352	YBM153	YBM253	YBD102	YB7315	YBD152	YBD152C	YBG101	YBG102	YBG105	YBG205	YB9320	YPD201	YBS103	YNG151	YNT251	YNG151C	YD101	YD201		
	 DM Medium Cut	WNMG060408-DM	0.8	0.5-3.0	0.15-0.50		●																							
		WNMG060412-DM	1.2	0.8-3.0	0.18-0.60	○	●																							
		WNMG06T308-DM	0.8	0.5-3.0	0.15-0.15					○																				
WNMG080404-DM		0.4	0.5-4.0	0.1-0.4		●																								
WNMG080408-DM		0.8	0.5-4.0	0.15-0.50	○	●				●																				
WNMG080412-DM		1.2	0.8-4.0	0.18-0.60	○	●				●																				
WNMG080416-DM		1.6	1-4	0.23-0.65		●																								
 EG Medium Cut	WNMG080408-EG	0.8	0.5-4.0	0.05-0.40							○	●							●	●										
	WNMG080412-EG	1.2	0.5-4.0	0.05-0.60							○	●								●	●									
 EM Medium Cut	WNMG060404-EM	0.4	0.5-3.0	0.05-0.30							○	●								●										
	WNMG060408-EM	0.8	0.5-3.0	0.1-0.5							●	●									●									
	WNMG06T304-EM	0.4	0.5-3.0	0.05-0.30							●																			
	WNMG06T308-EM	0.8	0.5-3.0	0.1-0.5							●																			
	WNMG06T312-EM	1.2	0.5-3.0	0.1-0.7							○											○								
	WNMG080404-EM	0.4	1-4	0.05-0.30							●	●										●								
	WNMG080408-EM	0.8	1-4	0.1-0.5							●	●										●								
WNMG080412-EM	1.2	1-4	0.1-0.7							●	●										●									

● Ex stock ○ On demand
 YBC152F, YBC252F, YBM153F, YBM253F available

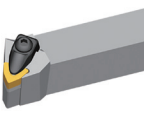
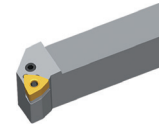
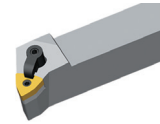
HC¹ Coated carbide
 HT Uncoated cermet
 HC² Coated cermet
 HW Uncoated carbide

Tool holder			
DWLNRL/L	PWLNRL/L	MWLNRL/L	S***-PWLNRL/L
Kr: 95°	Kr: 95°	Kr: 95°	Kr: 95°
			
A236	A251	A266	A332

System code > A48

Grade selection > A42

Technical info > A501

Cutting data > A366

- Ideal machining conditions
- ● Normal machining conditions
- ● ● Unfavourable machining conditions

WNMG	L	I.C	S	d
06 04	6.5	9.525	4.76	3.81
08 04	8.7	12.7	4.76	5.16

Turning inserts

WN** negative insert				HC ¹ (CVD)							HC ¹ (PVD)			HT	HC ²	HW												
				P	M	K	N	S	H																			
ISO	r	a _p	f	YBC103	YB6315	YBC152	YBC203	YBC252	YBC352	YBM153	YBM253	YBD102	YB7315	YBD152	YBD152C	YBG101	YBG102	YBG105	YBG205	YB9320	YPD201	YBS103	YNG151	YNT251	YNG151C	YD101	YD201	
PM Medium Cut	WNMG060408-PM			0.8	0.5-3.0	0.15-0.50																						
	WNMG060412-PM			1.2	0.8-3.0	0.18-0.60																						
	WNMG080404-PM			0.4	0.4-4.0	0.12-0.40																						
	WNMG080408-PM			0.8	0.5-4.0	0.15-0.50																						
	WNMG080412-PM			1.2	0.8-4.0	0.18-0.60																						
	WNMG080416-PM			1.6	1-4	0.23-0.65																						
ZM Medium Cut	WNMG080408-ZM			0.8	0.5-4.0	0.1-0.5																						
	WNMG080412-ZM			1.2	1.0-5.5	0.15-0.60																						
SNR Roughing	WNMG080408-SNR			0.8	1-3	0.1-0.5																						
	WNMG080412-SNR			1.2	1-3	0.2-0.6																						

● Ex stock ○ On demand
 YBC152F, YBC252F, YBM153F, YBM253F available

HC¹ Coated carbide
 HT Uncoated cermet
 HC² Coated cermet
 HW Uncoated carbide

Tool holder			
DWLNRL/L	PWLNRL/L	MWLNRL/L	S***-PWLNRL/L
Kr: 95°	Kr: 95°	Kr: 95°	Kr: 95°
A236	A251	A266	A332

System code > A48

Grade selection > A42

Technical info > A501

Cutting data > A366



A

Turning

B

Milling

C

Drilling

D

Technical Information

E

Index

General turning Negative inserts

A

Turning

- Ideal machining conditions
- ⊗ Normal machining conditions
- ⊗ Unfavourable machining conditions

WNMG	L	I.C	S	d
08 04	8.7	12.7	4.76	5.16

Turning inserts

WN** negative insert		HC ¹ (CVD)						HC ¹ (PVD)			HT	HC ²	HW			
	P	●	●	●	⊗	⊗	⊗			⊗	⊗	●	⊗	●		
	M						●	⊗	●	●	⊗	⊗	⊗	●		
	K															
	N									●	●				●	⊗
	S															
	H															

B

Milling

ISO		r	a _p	f	YBC103	YB6315	YBC152	YBC203	YBC252	YBC352	YBM153	YBM253	YBD102	YB7315	YBD152	YBD152C	YBG101	YBG102	YBG105	YBG205	YB9320	YPD201	YBS103	YNG151	YNT251	YNG151C	YD101	YD201		
 Medium Cut	NM																													
	WNMG080404-NM	0.4	0.2-3.0	0.05-0.30																●										
	WNMG080408-NM	0.8	0.2-3.0	0.1-0.3																●	●	○								
WNMG080412-NM	1.2	0.2-4.0	0.1-0.4																●	●										
 Medium Cut	TC																													
	WNMG080404-TC	0.4	0.5-3.0	0.08-0.25										●			○													
	WNMG080408-TC	0.8	0.5-4.0	0.15-0.40										●			●													
WNMG080412-TC	1.2	0.5-4.0	0.2-0.6										●			●														
 Medium Cut	TK																													
	WNMG080408-TK	0.8	0.2-0.4	0.2-0.4										●																
	WNMG080412-TK	1.2	0.2-0.4	0.2-0.45										○																
WNMG080416-TK	1.6	0.2-0.4	0.2-0.5										○																	

● Ex stock ○ On demand

HC¹ Coated carbide
 HT Uncoated cermet
 HC² Coated cermet
 HW Uncoated carbide

D

Technical Information

Tool holder			
DWLNR/L	PWLNRL	MWLNRL	S***-PWLNR/L
Kr: 95°	Kr: 95°	Kr: 95°	Kr: 95°
A236	A251	A266	A332

F

Index

System code > A48

Grade selection > A42



Technical info > A501

Cutting data > A366

WN**	L	I.C	S	d
06 T3	6.5	9.525	3.97	3.81
06 04	6.5	9.525	4.76	3.81
08 04	8.7	12.7	4.76	5.16

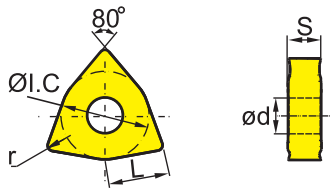

- Ideal machining conditions
- ⊗ Normal machining conditions
- ⊗ Unfavourable machining conditions

Turning inserts

WN** negative insert				HC ¹ (CVD)								HC ¹ (PVD)			HT	HC ²	HW										
				P	M	K	N	S	H																		
																											
ISO	r	a _p	f	YBC103	YB6315	YBC152	YBC203	YBC252	YBC352	YBM153	YBM253	YBD102	YB7315	YBD152	YBD152C	YBG101	YBG102	YBG105	YBG205	YB9320	YPD201	YBS103	YNG151	YNT251	YNG151C	YD101	YD201
DR 	WNMG060408-DR	0.8	0.7-3.5	0.20-0.45	●	●						●	●														
	WNMG060412-DR	1.2	0.8-3.5	0.25-0.55	●	●						○	○														
	WNMG080408-DR	0.8	0.7-5.0	0.20-0.55	●	●	●					●	●														
	WNMG080412-DR	1.2	1-5	0.25-0.70	○	●	●	●				●	●														
Roughing	WNMG080416-DR	1.6	1.5-5.0	0.32-0.75	○	●	●					●	○														
Flat 	WNMA060408	0.8	0.5-3.0	0.1-0.3								●	●														
	WNMA060412	1.2	0.5-3.0	0.15-0.30									●														
	WNMA06T308	0.8	0.5-3.0	0.1-0.3																							
	WNMA080404	0.4	0.5-4.0	0.08-0.25								○	●	○													
	WNMA080408	0.8	0.5-4.0	0.15-0.30								●	●	●													
	WNMA080412	1.2	0.5-5.0	0.15-0.30								●	○	●													
	WNMA080416	1.6	0.5-5.0	0.2-0.5								○	○	○													

● Ex stock ○ On demand
YBC152F, YBC252F, YBM153F, YBM253F available

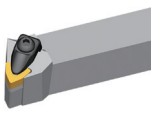
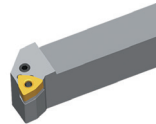
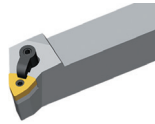
HC¹ Coated carbide
HT Uncoated cermet
HC² Coated cermet
HW Uncoated carbide

Tool holder			
DWLNLR/L	PWLNLR/L	MWLNLR/L	S***-PWLNLR/L
Kr: 95°	Kr: 95°	Kr: 95°	Kr: 95°
			
A236	A251	A266	A332

System code > A48

Grade selection > A42

Technical info > A501

Cutting data > A366



A

Turning

- Ideal machining conditions
- ⊗ Normal machining conditions
- ⊗ Unfavourable machining conditions

RNMG	L	I.C	S	d
12 04	12.7	12.7	4.76	5.16

Turning inserts

RN** negative insert			HC ¹ (CVD)										HC ¹ (PVD)		HT	HC ²	HW										
	P		●	●	●	⊗	⊗	⊗							●	⊗	●										
	M							●	⊗		●	●	⊗	⊗	⊗	●	⊗	●									
	K									●	⊗	⊗	⊗														
	N												●	●					●	⊗							
	S														●	⊗	⊗	⊗	⊗	⊗							
	H																										
ISO	a _p	f	YBC103	YB6315	YBC152	YBC203	YBC252	YBC352	YBM153	YBM253	YBD102	YB7315	YBD152	YBD152C	YBG101	YBG102	YBG105	YBG205	YB9320	YPD201	YBS103	YNG151	YNT251	YNG151C	YD101	YD201	
Basic	RNMG120400	0.5-7.0	0.1-1.8										○	○													
Medium Cut																											

● Ex stock ○ On demand

HC¹ Coated carbide
 HT Uncoated cermet
 HC² Coated cermet
 HW Uncoated carbide

B

Milling

C

Drilling

D

Technical Information

E

Index

Tool holder	
MRDNN	MRGNR/L
A267	A268

System code > A48

Grade selection > A42

Technical info > A501

Cutting data > A366

- Ideal machining conditions
- Normal machining conditions
- Unfavourable machining conditions

KNUX	L	I.W	S
16 04		9.525	4.76

Turning inserts

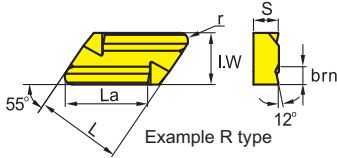

KN** negative insert							HC ¹ (CVD)					HC ¹ (PVD)			HT	HC ²	HW																
							P	M	K	N	S	H																					
 KNUX Finishing	ISO	La	brn	r	a _p	f	YBC103	YB6315	YBC152	YBC203	YBC252	YBC352	YBM153	YBM253	YBD102	YB7315	YBD152	YBD152C	YBG101	YBG102	YBG105	YBG205	YB9320	YPD201	YBS103	YNG151	YNT251	YNG151C	YD101	YD201			
	KNUX160405L11	16	2.2	0.5	0.2-6.0	0.05-0.70						●																			○		
	KNUX160405L12	16	2.2	0.5	0.2-6.0	0.05-0.70																											
	KNUX160405R11	16	2.2	0.5	0.2-6.0	0.05-0.70						●																					
	KNUX160405R12	16	2.2	0.5	0.2-6.0	0.05-0.70																											
	KNUX160410L11	16	2.2	1	0.2-6.0	0.05-0.70																											
	KNUX160410L12	16	2.2	1	0.2-6.0	0.05-0.70			○																								
	KNUX160410R11	16	2.2	1	0.2-6.0	0.05-0.70							●																				
KNUX160410R12	16	2.2	1	0.2-6.0	0.05-0.70																												

● Ex stock ○ On demand
 YBC152F, YBC252F, YBM153F, YBM253F available

HC¹ Coated carbide
 HT Uncoated cermet
 HC² Coated cermet
 HW Uncoated carbide

Tool holder	
CKJNR/L	CKNNR/L
Kr: 93°	Kr: 63°
A290	A291

General turning Negative inserts

A

Turning

- Ideal machining conditions
- ⊗ Normal machining conditions
- ⊗ Unfavourable machining conditions

CN**	L	I.C	S	d
19 07	19.3	19.05	7.94	7.93
19 11	19.3	19.05	11	7.8

Turning inserts

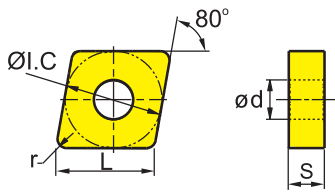

CN** negative insert				HC ¹ (CVD)										HC ¹ (PVD)		HT	HC ²	HW										
				P	●	●	●	●	●	●	●	●	●	●	●	●	●	●	●	●	●							
				M	●	●	●	●	●	●	●	●	●	●	●	●	●	●	●	●	●							
				K	●	●	●	●	●	●	●	●	●	●	●	●	●	●	●	●	●							
				N	●	●	●	●	●	●	●	●	●	●	●	●	●	●	●	●	●							
				S	●	●	●	●	●	●	●	●	●	●	●	●	●	●	●	●	●							
				H	●	●	●	●	●	●	●	●	●	●	●	●	●	●	●	●	●							
ISO	r	a _p	f	YBC103	YB6315	YBC152	YBC203	YBC252	YBC352	YBM153	YBM253	YBD102	YB7315	YBD152	YBD152C	YBG101	YBG102	YBG105	YBG205	YB9320	YPD201	YBS103	YNG151	YNT251	YNG151C	YD101	YD201	
RF	CNMG191140-RF	4	1.0-5.5	0.20-0.60	●																							
Finishing																												
RF	CNMM190740-RF	4	1.0-5.5	0.20-0.60	●																							
Finishing	CNMM191140-RF	4	1.0-5.5	0.20-0.60	●																							
RH	CNMM190740-RH	4	1.5-7.0	0.35-1.20	●	●																						
Roughing	CNMM191140-RH	4	1.5-7.0	0.35-1.20	●	●																						

● Ex stock ○ On demand

HC¹ Coated carbide
 HT Uncoated cermet
 HC² Coated cermet
 HW Uncoated carbide

B

Milling

C

Drilling

D

Technical Information

E

Index

Tool holder

PCLNR/L

Kr: 95°



A318



Turning inserts

- Ideal machining conditions
- Normal machining conditions
- Unfavourable machining conditions

LNUX	L	I.C	S	d
19 19	19.05	10	19.05	6.35
30 19	30	10	19.05	6.35

LN** negative insert				HC ¹ (CVD)								HC ¹ (PVD)			HT	HC ²	HW										
				P	M	K	N	S	H																		
ISO	r	a _p	f	YBC103	YB6315	YBC152	YBC203	YBC252	YBC352	YBM153	YBM253	YBD102	YB7315	YBD152	YBD152C	YBG101	YBG102	YBG105	YBG205	YB9320	YPD201	YBS103	YNG151	YNT251	YNG151C	YD101	YD201
RF Heavy Turning	LNUX191940-RF	4	1,0-5,5	0,20-0,60	●	●																					
	LNUX301940-RF	4	1,0-6,0	0,20-0,70	●	○																					
RH Heavy Turning	LNUX191940-RH	4	1,5-7,0	0,35-1,20	●	●																					
	LNUX301940-RH	4	1,5-8,0	0,35-1,40	●	●																					

● Ex stock ○ On demand

HC¹ Coated carbide
 HT Uncoated cermet
 HC² Coated cermet
 HW Uncoated carbide

Tool holder	
PLANR/L Kr: 90°	PLFNR/L Kr: 90°
A316	A317

General turning Positive inserts

A

Turning

- Ideal machining conditions
- ⊗ Normal machining conditions
- ⊗ Unfavourable machining conditions

CCGT	L	I.C	S	d
06 02	6.4	6.35	2.38	2.8
09 T3	9.7	9.525	3.97	4.4

Turning inserts

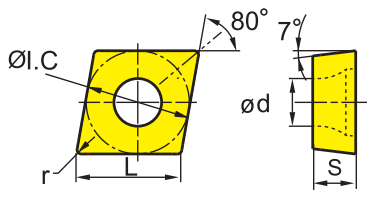

CC** positive insert				HC ¹ (CVD)								HC ¹ (PVD)		HT	HC ²	HW													
				P	M	K	N	S	H																				
	ISO	r	a _p	f	YBC103	YB6315	YBC152	YBC203	YBC252	YBC352	YBM153	YBM253	YBD102	YB7315	YBD152	YBD152C	YBG101	YBG102	YBG105	YBG205	YB9320	YPD201	YBS103	YNG151	YNT251	YNG151C	YD101	YD201	
SF	CCGT060202-SF	0.2	0.05-2.00	0.05-0.18																									
	CCGT060204-SF	0.4	0.05-2.00	0.05-0.35																									
	CCGT09T304-SF	0.4	0.05-2.00	0.05-0.35																									
Finishing																													
USF	CCGT060202L-USF	0.2	0.05-2.00	0.05-0.18																									
	CCGT060204L-USF	0.4	0.05-2.00	0.05-0.35																									
	CCGT09T301L-USF	0.1	0.2-2.0	0.01-0.08																									
Finishing	CCGT09T302L-USF	0.2	0.2-2.0	0.05-0.18																									
	CCGT09T304L-USF	0.4	0.2-2.0	0.05-0.20																									
USF	CCGT09T304R-USF	0.4	0.2-2.0	0.05-0.20																									
Finishing																													

● Ex stock ○ On demand

HC¹ Coated carbide
 HT Uncoated cermet
 HC² Coated cermet
 HW Uncoated carbide

B

Milling

C

Drilling

D

Technical Information

E

Index

Tool holder						
SCACR/L	SCLCR/L	SCACR/L-SC	SCLCR/L-SC	S***-SCLCR/L	S***-SCFCR/L	S***-SCLCR
Kr: 90°	Kr: 95°	Kr: 90°	Kr: 95°	Kr: 95°	Kr: 90°	Kr: 95°
A269	A270	A306	A307	A334	A352	A353

E***-SCLCR/L
Kr: 95°
A355



CCMT	L	I.C	S	d
06 02	6.4	6.35	2.38	2.8
09 T3	9.7	9.525	3.97	4.4
12 04	12.9	12.7	4.76	5.56

- Ideal machining conditions
- ● Normal machining conditions
- ● Unfavourable machining conditions

Turning inserts

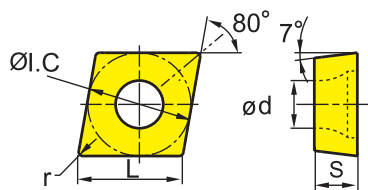

CC** positive insert				HC ¹ (CVD)								HC ¹ (PVD)			HT	HC ²	HW																
				P	M	K	N	S	H																								
ISO				r	a _p	f	YBC103	YB6315	YBC152	YBC203	YBC252	YBC352	YBM153	YBM253	YBD102	YB7315	YBD152	YBD152C	YBG101	YBG102	YBG105	YBG205	YB9320	YPD201	YBS103	YNG151	YNT251	YNG151C	YD101	YD201			
AHF Finishing	CCMT060204-AHF	0.4	0.2-2.5	0.05-0.20	●																												
	CCMT060208-AHF	0.8	0.3-2.5	0.05-0.30	○																												
	CCMT09T302-AHF	0.2	0.08-2.00	0.04-0.15																													
	CCMT09T304-AHF	0.4	0.2-3.0	0.05-0.30	●																		○	●	○								
	CCMT09T308-AHF	0.8	0.3-3.0	0.05-0.40	●																		○	●									
	CCMT120404-AHF	0.4	0.5-4.0	0.05-0.30	○																		○	●									
	CCMT120408-AHF	0.8	0.8-4.0	0.08-0.40	●																			●									
HF Finishing	CCMT060202-HF	0.2	0.06-1.70	0.03-0.11		●	●																										
	CCMT060204-HF	0.4	0.1-1.7	0.05-0.17		●	●																										
	CCMT060208-HF	0.8	0.1-1.7	0.05-0.30		○	●																										
	CCMT09T302-HF	0.2	0.08-2.00	0.04-0.15		●	●																										
	CCMT09T304-HF	0.4	0.11-2.00	0.06-0.23		●	●									○	●																
	CCMT09T308-HF	0.8	0.15-2.00	0.08-0.30		●	●									○	●																
	CCMT120404-HF	0.4	0.14-2.40	0.07-0.27		●	●																										
CCMT120408-HF	0.8	0.2-3.0	0.08-0.30		●	○																											

● Ex stock ○ On demand

YBC152F, YBC252F, YBM153F, YBM253F available

HC¹ Coated carbide
 HT Uncoated cermet
 HC² Coated cermet
 HW Uncoated carbide

Tool holder

SCACR/L	SCLCR/L	SCACR/L-SC	SCLCR/L-SC	A***-SCLCR/L	S***-SCFCR/L	S***-SCLCR
Kr: 90°	Kr: 95°	Kr: 90°	Kr: 95°	Kr: 95°	Kr: 90°	Kr: 95°
A269	A270	A306	A307	A334	A352	A353

E*-SCLCR/L**

Kr: 95°



A355

System code > A48

Grade selection > A42

Technical info > A501

Cutting data > A366



A Turning
B Milling
C Drilling
D Technical Information
E Index

A

Turning

B

Milling

C

Drilling

D

Technical Information

E

Index

	CCMT	L	I.C	S	d
	06 02	6.4	6.35	2.38	2.8
	09 T3	9.7	9.525	3.97	4.4
	12 04	12.9	12.7	4.76	5.56

- Ideal machining conditions
- ⊗ Normal machining conditions
- ⊛ Unfavourable machining conditions



Turning inserts

CC** positive insert				HC ¹ (CVD)								HC ¹ (PVD)				HT	HC ²	HW																		
ISO	r	a _p	f	P	M	K	N	S	H	YBC103	YB6315	YBC152	YBC203	YBC252	YBC352	YBM153	YBM253	YBD102	YB7315	YBD152	YBD152C	YBG101	YBG102	YBG105	YBG205	YB9320	YPD201	YBS103	YNG151	YNT251	YNG151C	YD101	YD201			
				EF	0.2	0.06-1.70	0.03-0.11	●	●	●	●	●	●							●																
EF	0.4	0.1-1.7	0.05-0.17													●																				
EF	0.2	0.08-2.00	0.04-0.15													○																				
EF	0.4	0.11-2.00	0.06-0.23													●																				
EF	0.8	0.15-2.00	0.08-0.30													●																				
EF	0.4	0.14-2.40	0.07-0.27													●																				
EF	0.8	0.2-3.0	0.1-0.3													●																				
XF	0.2	0.5-1.5	0.08-0.15										●																							
XF	0.8	0.5-1.5	0.08-0.20									●																								
XF	0.2	0.5-2.0	0.08-0.15									●	●																							
XF	0.8	0.5-2.0	0.08-0.25									●	○																							

● Ex stock ○ On demand
 YBC152F, YBC252F, YBM153F, YBM253F available

HC¹ Coated carbide
 HT Uncoated cermet
 HC² Coated cermet
 HW Uncoated carbide

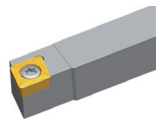
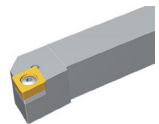
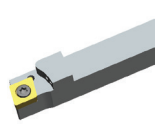
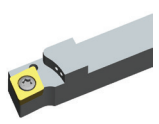
Tool holder

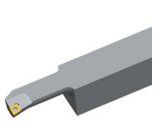
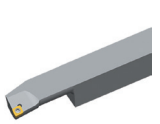
SCACR/L	SCLCR/L	SCACR/L-SC	SCLCR/L-SC	A***-SCLCR/L	S***-SCFCR/L	S***-SCLCR
Kr: 90°	Kr: 95°	Kr: 90°	Kr: 95°	Kr: 95°	Kr: 90°	Kr: 95°
						
A269	A270	A306	A307	A334	A352	A353

E***-SCLCR/L
 Kr: 95°



System code > A48

Grade selection > A42



Technical info > A501

Cutting data > A366

CCMT	L	I.C	S	d
06 02	6.4	6.35	2.38	2.8
09 T3	9.7	9.525	3.97	4.4
12 04	12.9	12.7	4.76	5.56

- Ideal machining conditions
- ⊗ Normal machining conditions
- ⊗ Unfavourable machining conditions

Turning inserts

CC** positive insert				HC ¹ (CVD)								HC ¹ (PVD)			HT	HC ²	HW									
ISO	r	a _p	f	P	M	K	N	S	H																	
				YBC103	YB6315	YBC152	YBC203	YBC252	YBC352	YBM153	YBM253	YBD102	YB7315	YBD152	YBD152C	YBG101	YBG102	YBG105	YBG205	YB9320	YPD201	YBS103	YNG151	YNT251	YNG151C	YD101
EM  Medium Cut	CCMT060204-EM	0.4	0.2-2.4	0.06-0.17																						
	CCMT060208-EM	0.8	0.4-2.4	0.08-0.23																						
	CCMT09T304-EM	0.4	0.25-3.00	0.08-0.23																						
	CCMT09T308-EM	0.8	0.5-3.0	0.1-0.3																						
	CCMT120404-EM	0.4	0.3-3.6	0.09-0.27																						
	CCMT120408-EM	0.8	0.6-3.6	0.12-0.36																						
	CCMT120412-EM	1.2	0.72-3.60	0.14-0.43																						
XM  Medium Cut	CCMT09T304-XM	0.4	1-2.5	0.15-0.3	●	○																				
	CCMT09T308-XM	0.8	1-2.5	0.15-0.35	●	●																				
	CCMT09T312-XM	1.2	1-2.5	0.15-0.4	●	●																				
	CCMT120404-XM	0.4	1-3.0	0.15-0.3	○	○																				
	CCMT120408-XM	0.8	1-3.0	0.15-0.35	○	○																				
CCMT120412-XM	1.2	1-3.0	0.15-0.4	○	○																					

● Ex stock ○ On demand
YBC152F, YBC252F, YBM153F, YBM253F available

HC¹ Coated carbide
HT Uncoated cermet
HC² Coated cermet
HW Uncoated carbide

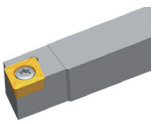
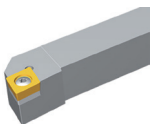
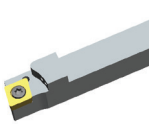
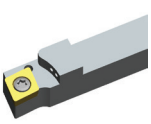
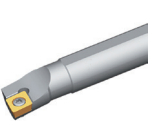
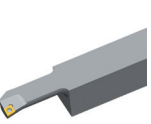
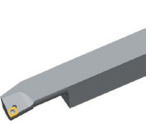
Tool holder						
SCACR/L	SCLCR/L	SCACR/L-SC	SCLCR/L-SC	A***-SCLCR/L	S***-SCFCR/L	S***-SCLCR
Kr: 90°	Kr: 95°	Kr: 90°	Kr: 95°	Kr: 95°	Kr: 90°	Kr: 95°
						
A269	A270	A306	A307	A334	A352	A353

E***-SCLCR/L
Kr: 95°

A355

A

Turning

B

Milling

C

Drilling

D

Technical Information

E

Index

- Ideal machining conditions
- ⊗ Normal machining conditions
- ⊗ Unfavourable machining conditions

CCMT	L	I.C	S	d
06 02	6.4	6.35	2.38	2.8
09 T3	9.7	9.525	3.97	4.4
12 04	12.9	12.7	4.76	5.56

Turning inserts

CC** positive insert				HC ¹ (CVD)								HC ¹ (PVD)				HT		HC ²		HW													
				P	M	K	N	S	H																								
ISO				r	a _p	f																											
										YBC103	YB6315	YBC152	YBC203	YBC252	YBC352	YBM153	YBM253	YBD102	YB7315	YBD152	YBD152C	YBG101	YBG102	YBG105	YBG205	YB9320	YPD201	YBS103	YNG151	YNT251	YNG151C	YD101	YD201
 HM Medium Cut	CCMT060204-HM			0.4	0.2-2.4	0.06-0.17																											
	CCMT060208-HM			0.8	0.2-3.0	0.08-0.20																											
	CCMT09T304-HM			0.4	0.25-3.00	0.08-0.23																											
	CCMT09T308-HM			0.8	0.5-3.0	0.1-0.3																											
	CCMT120404-HM			0.4	0.3-3.6	0.09-0.27																											
	CCMT120408-HM			0.8	0.6-3.6	0.12-0.36																											
	CCMT120412-HM			1.2	0.72-3.60	0.14-0.43																											

● Ex stock ○ On demand
 YBC152F, YBC252F, YBM153F, YBM253F available

HC¹ Coated carbide
 HT Uncoated cermet
 HC² Coated cermet
 HW Uncoated carbide

Tool holder						
SCACR/L	SCLCR/L	SCACR/L-SC	SCLCR/L-SC	A***-SCLCR/L	S***-SCFCR/L	S***-SCLCR
Kr: 90°	Kr: 95°	Kr: 90°	Kr: 95°	Kr: 95°	Kr: 90°	Kr: 95°
A269	A270	A306	A307	A334	A352	A353

E***-SCLCR/L
Kr: 95°
A355



CC**	L	I.C	S	d
06 02	6.4	6.35	2.38	2.8
09 T3	9.7	9.525	3.97	4.4
12 04	12.9	12.7	4.76	5.56

- Ideal machining conditions
- Normal machining conditions
- Unfavourable machining conditions

Turning inserts

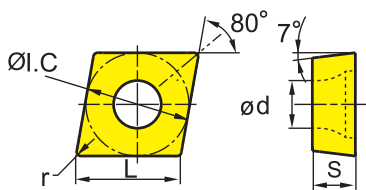

CC** positive insert				HC ¹ (CVD)								HC ¹ (PVD)			HT	HC ²	HW														
				P	M	K	N	S	H																						
ISO				r	a _p	f	YBC103	YB6315	YBC152	YBC203	YBC252	YBC352	YBM153	YBM253	YBD102	YB7315	YBD152	YBD152C	YBG101	YBG102	YBG105	YBG205	YB9320	YPD201	YBS103	YNG151	YNT251	YNG151C	YD101	YD201	
Basic 	CCMW09T304	0.4	0.1-5.0	0.05-0.50																											
	CCMW120404	0.4	0.2-5.0	0.05-0.50																											○
	CCMW120408	0.8	0.5-5.0	0.08-0.50														○													○
Medium Cut 	TC																														
	CCMT060204-TC	0.4	0.5-3.0	0.1-0.3												○			●												
	CCMT09T304-TC	0.4	0.5-3.0	0.1-0.3												○			●												
	CCMT09T308-TC	0.8	0.5-3.0	0.1-0.4												●			●												
	CCMT120404-TC	0.4	1-4	0.1-0.3												●			●												
CCMT120408-TC	0.8	1-4	0.1-0.4												●			●													
HR 	CCMT060204-HR	0.4	0.5-3.0	0.05-0.24		●	●																								
	CCMT060208-HR	0.8	0.8-3.2	0.09-0.26		●	○										●														
	CCMT09T304-HR	0.4	0.2-4.0	0.05-0.30		●	●											●													
	CCMT09T308-HR	0.8	1-4	0.12-0.35		●	●									●			●												
	CCMT120408-HR	0.8	1.2-4.8	0.14-0.42		●	●									●			●												
	CCMT120412-HR	1.2	1.44-4.80	0.17-0.50		●	●									○															

● Ex stock ○ On demand
YBC152F, YBC252F, YBM153F, YBM253F available

HC¹ Coated carbide
HT Uncoated cermet
HC² Coated cermet
HW Uncoated carbide

Tool holder

SCACR/L	SCLCR/L	SCACR/L-SC	SCLCR/L-SC	A***-SCLCR/L	S***-SCFCR/L	S***-SCLCR
Kr: 90°	Kr: 95°	Kr: 90°	Kr: 95°	Kr: 95°	Kr: 90°	Kr: 95°
A269	A270	A306	A307	A334	A352	A353

E*-SCLCR/L**

Kr: 95°



A355

System code > A48

Grade selection > A42

Technical info > A501

Cutting data > A366



General turning Positive inserts

A

Turning

B

Milling

C

Drilling

D

Technical Information

E

Index

- Ideal machining conditions
- ⊗ Normal machining conditions
- ⊛ Unfavourable machining conditions

CCGX	L	I.C	S	d
06 02	6.4	6.35	2.38	2.8
09 T3	9.7	9.525	3.97	4.4
12 04	12.9	12.7	4.76	5.56

Turning inserts

CC** positive insert				HC ¹ (CVD)										HC ¹ (PVD)			HT	HC ²	HW															
ISO	r	a _p	f	P	M	K	N	S	H	YBC103	YB6315	YBC152	YBC203	YBC252	YBC352	YBM153	YBM253	YBD102	YB7315	YBD152	YBD152C	YBG101	YBG102	YBG105	YBG205	YB9320	YPD201	YBS103	YNG151	YNT251	YNG151C	YD101	YD201	
				LC	CCGX060202-LC	0.2	0.3-3.0	0.05-0.15	●	●	●	●	●													●	●	●	●	●	●	●		
	CCGX060204-LC	0.4	0.5-3.0	0.1-0.3																		●	●	●	●	●	●	●				●		
Alum Machining	CCGX09T302-LC	0.2	0.5-4.0	0.1-0.2																		●	●	●	●	●	●	●				●		
	CCGX09T304-LC	0.4	0.5-5.0	0.1-0.3																			●	●	●	●	●	●	●				●	
	CCGX09T308-LC	0.8	0.5-5.0	0.15-0.60																		●	●	●	●	●	●	●				●		
	CCGX120404-LC	0.4	0.5-7.0	0.1-0.3																		●	●	●	●	●	●	●				●		
	CCGX120408-LC	0.8	0.5-7.0	0.15-0.60																		●	●	●	●	●	●	●				●		
LH	CCGX060202-LH	0.2	0.3-3.0	0.05-0.15																		●	●	●	●	●	●	●				●		
	CCGX060204-LH	0.4	0.5-3.0	0.1-0.3																			●	●	●	●	●	●	●				●	
	CCGX060208-LH	0.8	0.6-3.0	0.15-0.40																			●	●	●	●	●	●	●				●	
	CCGX09T302-LH	0.2	0.4-5.0	0.05-0.15																			●	●	●	●	●	●	●				●	
	CCGX09T304-LH	0.4	0.5-5.0	0.1-0.3																			●	●	●	●	●	●	●				●	
	CCGX09T308-LH	0.8	0.5-5.0	0.15-0.60																			●	●	●	●	●	●	●				●	
	CCGX120402-LH	0.2	0.4-7.0	0.05-0.15																			○	○	○	○	○	○	○				○	
	CCGX120404-LH	0.4	0.5-7.0	0.1-0.3																			●	●	●	●	●	●	●				●	
	CCGX120408-LH	0.8	0.5-7.0	0.15-0.60																			●	●	●	●	●	●	●				●	
	CCGX120412-LH	1.2	0.5-7.0	0.15-0.80																			○	○	○	○	○	○	○				○	

● Ex stock ○ On demand

HC¹ Coated carbide
 HT Uncoated cermet
 HC² Coated cermet
 HW Uncoated carbide



System code > A48

Grade selection > A42

Technical info > A501

Cutting data > A366

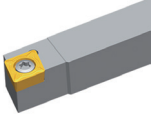
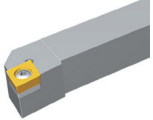
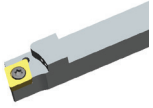
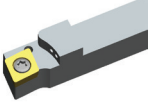
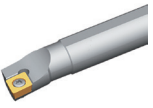
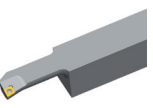

Tool holder						
SCACR/L	SCLCR/L	SCACR/L-SC	SCLCR/L-SC	A***-SCLCR/L	S***-SCFCR/L	S***-SCLCR
Kr: 90°	Kr: 95°	Kr: 90°	Kr: 95°	Kr: 95°	Kr: 90°	Kr: 95°
						
A269	A270	A306	A307	A334	A352	A353

E***-SCLCR/L
Kr: 95°

A355

A	Turning
B	Milling
C	Drilling
D	Technical Information
E	Index

System code > A48

Grade selection > A42

Technical info > A501

Cutting data > A366

General turning Positive inserts

A

Turning

- Ideal machining conditions
- ⊗ Normal machining conditions
- ⊗ Unfavourable machining conditions

CP**	L	I.C	S	d
06 02	6.4	6.35	2.38	2.8
09 T3	9.7	9.525	3.97	4.4

Turning inserts

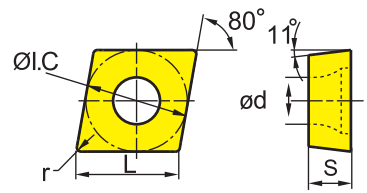

CP** positive insert					HC ¹ (CVD)								HC ¹ (PVD)		HT	HC ²	HW												
					P	M	K	N	S	H																			
	ISO	r	a _p	f	YBC103	YB6315	YBC152	YBC203	YBC252	YBC352	YBM153	YBM253	YBD102	YB7315	YBD152	YBD152C	YBG101	YBG102	YBG105	YBG205	YB9320	YPD201	YBS103	YNG151	YNT251	YNG151C	YD101	YD201	
HF 	CPMT060204-HF	0.4	0.1-1.5	0.04-0.18			○																						
	CPMT060208-HF	0.8	0.1-1.5	0.05-0.25																	○								
SF 	CPGT060202-SF	0.2	0.05-2.00	0.05-0.25																					○	○			
	CPGT060204-SF	0.4	0.05-2.00	0.05-0.35																					●	●			
	CPGT09T304-SF	0.4	0.05-2.00	0.05-0.35																					●	●			
Flat 	CPGW060204	0.4	0.5-1.5	0.05-0.40																							○		
HM 	CPMT09T304-HM	0.4	0.2-3.5	0.05-0.35																●									
	CPMT09T308-HM	0.8	0.2-3.5	0.10-0.55					○																				

● Ex stock ○ On demand
 YBC152F, YBC252F, YBM153F, YBM253F available

HC¹ Coated carbide
 HT Uncoated cermet
 HC² Coated cermet
 HW Uncoated carbide

B

Milling

C

Drilling

D

Technical Information

E

Index

Tool holder	
S***-SCLPR/L	C***-SCLPR/L
Kr: 95°	Kr: 95°
A348	A354



- Ideal machining conditions
- Normal machining conditions
- Unfavourable machining conditions

DC**	L	I.C	S	d
07 02	7.8	6.35	2.38	2.8
11 T3	11.6	9.525	3.97	4.4

Turning inserts

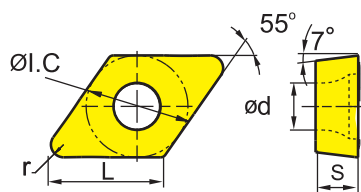

DC** positive insert				HC ¹ (CVD)								HC ¹ (PVD)				HT	HC ²	HW									
				P	M	K	N	S	H																		
ISO	r	a _p	f	YBC103	YB6315	YBC152	YBC203	YBC252	YBC352	YBM153	YBM253	YBD102	YBD7315	YBD152	YBD152C	YBG101	YBG102	YBG105	YBG205	YB9320	YPD201	YBS103	YNG151	YNT251	YNG151C	YD101	YD201
AHF 	DCMT070204-AHF	0.4	0.2-2.5	0.05-0.20	○														○ ●				●				
	DCMT11T302-AHF	0.2	0.5-3.0	0.05-0.15	○														● ●				● ●				
	DCMT11T304-AHF	0.4	0.5-3.0	0.05-0.30	●														● ●				● ●				
	DCMT11T308-AHF	0.8	0.5-3.0	0.05-0.40	●														●				● ●				
SF 	DCGT070202-SF	0.2	0.05-1.50	0.05-0.15																			● ●	○			
	DCGT070204-SF	0.4	0.05-1.50	0.05-0.20																				○	●		
	DCGT070208-SF	0.8	0.05-1.50	0.05-0.30																					●		
	DCGT11T302-SF	0.2	0.05-2.00	0.05-0.15													○							○ ● ●			
	DCGT11T304-SF	0.4	0.05-2.00	0.05-0.20																				● ● ●			
DCGT11T308-SF	0.8	0.05-2.00	0.05-0.30																				● ●	●			

● Ex stock ○ On demand

YBC152F, YBC252F, YBM153F, YBM253F available

HC¹ Coated carbide
HT Uncoated cermet
HC² Coated cermet
HW Uncoated carbide

Tool holder

SDACR/L	SDJCR/L	SDNCN	SDACR/L-SC	SDHCR/L-SC	SDJCR/L-SC	SDNCN-SC
Kr: 90°	Kr: 93°	Kr: 62°30'	Kr: 90°	Kr: 107°30'	Kr: 93°	Kr: 62°30'
A271	A272	A273	A308	A309	A310	A311
S***-SDQCR/L	A***-SDUCR/L	S***-SDZCR/L	E***-SDQCR/L			
Kr: 107°30'	Kr: 93°	Kr: 85°	Kr: 107°30'			
A336	A337	A338	A357			

System code > A48

Grade selection > A42

Technical info > A501

Cutting data > A366



A

Turning

- Ideal machining conditions
- ⊗ Normal machining conditions
- ⊗ Unfavourable machining conditions

DCMT	L	I.C	S	d
07 02	7.8	6.35	2.38	2.8
11 T3	11.6	9.525	3.97	4.4

Turning inserts

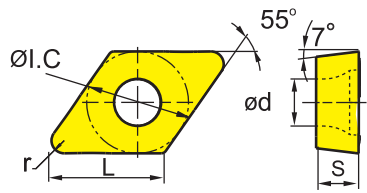

DC** positive insert					HC ¹ (CVD)								HC ¹ (PVD)		HT	HC ²	HW																
					P	●	●	●	●	●	●	●	●	●	●	●	●																
					M				●	●	●	●	●	●	●	●																	
					K																												
					N						●	●					●																
					S																												
					H																												
ISO					r	a _p	f	YBC103	YB6315	YBC152	YBC203	YBC252	YBC352	YBM153	YBM253	YBD102	YB7315	YBD152	YBD152C	YBG101	YBG102	YBG105	YBG205	YB9320	YPD201	YBS103	YNG151	YNT251	YNG151C	YD101	YD201		
EF	DCMT070202-EF	0.2	0.06-1.50	0.03-0.11										○																			
	DCMT070204-EF	0.4	0.08-1.50	0.05-0.17										●									●										
	DCMT11T302-EF	0.2	0.08-2.00	0.04-0.15										○									●										
	DCMT11T304-EF	0.4	0.11-2.00	0.06-0.23										●									●										
Finishing	DCMT11T308-EF	0.8	0.15-2.00	0.08-0.30									●									●	●										
	DCMT070202-HF	0.2	0.06-1.50	0.03-0.11						○	●																						
HF	DCMT070204-HF	0.4	0.08-1.50	0.05-0.17						●	●																						
	DCMT070208-HF	0.8	0.08-1.50	0.05-0.30						●	○																						
	DCMT11T302-HF	0.2	0.08-2.00	0.04-0.15						○	●												○										
	DCMT11T304-HF	0.4	0.11-2.00	0.06-0.23						●	●																						
Finishing	DCMT11T308-HF	0.8	0.15-2.00	0.08-0.30						●	●																						
	DCMT070202-XF	0.2	0.5-1.5	0.08-0.15							○																						
	DCMT070204-XF	0.4	0.5-1.5	0.08-0.15						○																							
	DCMT070208-XF	0.8	0.5-1.5	0.08-0.25						○																							
Finishing	DCMT11T304-XF	0.4	0.5-2.0	0.08-0.15						○																							
	DCMT11T308-XF	0.8	0.5-2.0	0.08-0.25						○																							

● Ex stock ○ On demand
 YBC152F, YBC252F, YBM153F, YBM253F available

HC¹ Coated carbide
 HT Uncoated cermet
 HC² Coated cermet
 HW Uncoated carbide

B

Milling

C

Drilling

D

Technical Information

E

Index

Tool holder						
SDACR/L	SDJCR/L	SDNCN	SDACR/L-SC	SDHCR/L-SC	SDJCR/L-SC	SDNCN-SC
Kr: 90°	Kr: 93°	Kr: 62°30'	Kr: 90°	Kr: 107°30'	Kr: 93°	Kr: 62°30'
A271	A272	A273	A308	A309	A310	A311
S***-SDQCR/L	A***-SDUCR/L	S***-SDZCR/L	E***-SDQCR/L			
Kr: 107°30'	Kr: 93°	Kr: 85°	Kr: 107°30'			
A336	A337	A338	A357			



- Ideal machining conditions
- Normal machining conditions
- Unfavourable machining conditions

DCMT	L	I.C	S	d
07 02	7.8	6.35	2.38	2.8
11 T3	11.6	9.525	3.97	4.4

Turning inserts

DC** positive insert				HC ¹ (CVD)							HC ¹ (PVD)			HT	HC ²	HW											
				P	M	K	N	S	H																		
ISO	r	a _p	f	YBC103	YB6315	YBC152	YBC203	YBC252	YBC352	YBM153	YBM253	YBD102	YB7315	YBD152	YBD152C	YBG101	YBG102	YBG105	YBG205	YB9320	YPD201	YBS103	YNG151	YNT251	YNG151C	YD101	YD201
EM	DCMT070204-EM	0.4	0.19-2.25	0.06-0.17						●	●								●								
	DCMT070208-EM	0.8	0.38-2.25	0.08-0.23						●	○								●								
	DCMT11T304-EM	0.4	0.25-3.00	0.08-0.23						●	●								●								
Medium Cut	DCMT11T308-EM	0.8	0.5-3.0	0.1-0.3						●	●								●								
XM	DCMT11T304-XM	0.4	1-2.5	0.15-0.3	●	○																					
	DCMT11T308-XM	0.8	1-2.5	0.15-0.35	●		●																				
Medium Cut	DCMT11T312-XM	1.2	1-2.5	0.15-0.4	●		●																				

● Ex stock ○ On demand
 YBC152F, YBC252F, YBM153F, YBM253F available

HC¹ Coated carbide
 HT Uncoated cermet
 HC² Coated cermet
 HW Uncoated carbide

Tool holder						
SDACR/L	SDJCR/L	SDNCN	SDACR/L-SC	SDHCR/L-SC	SDJCR/L-SC	SDNCN-SC
Kr: 90°	Kr: 93°	Kr: 62°30'	Kr: 90°	Kr: 107°30'	Kr: 93°	Kr: 62°30'
A271	A272	A273	A308	A309	A310	A311
S***-SDQCR/L	A***-SDUCR/L	S***-SDZCR/L	E***-SDQCR/L			
Kr: 107°30'	Kr: 93°	Kr: 85°	Kr: 107°30'			
A336	A337	A338	A357			

A Turning
B Milling
C Drilling
D Technical Information
E Index

A

Turning

- Ideal machining conditions
- ⊗ Normal machining conditions
- ⊗ Unfavourable machining conditions

DCMT	L	I.C	S	d
07 02	7.8	6.35	2.38	2.8
11 T3	11.6	9.525	3.97	4.4

Turning inserts

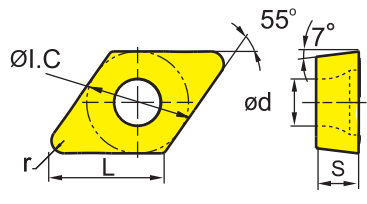

DC** positive insert				HC ¹ (CVD)								HC ¹ (PVD)		HT	HC ²	HW											
ISO	r	a _p	f	YBC103	YB6315	YBC152	YBC203	YBC252	YBC352	YBM153	YBM253	YBD102	YB7315	YBD152	YBD152C	YBG101	YBG102	YBG105	YBG205	YB9320	YPD201	YBS103	YNG151	YNT251	YNG151C	YD101	YD201
HM	DCMT070204-HM	0.4	0.19-2.25	0.06-0.17	○	●	●					●	●						●								
	DCMT070208-HM	0.8	0.38-2.25	0.08-0.23		●	●					●	●														
	DCMT11T304-HM	0.4	0.25-3.00	0.08-0.23	○	●	●					●	●							●							
	DCMT11T308-HM	0.8	0.5-3.0	0.1-0.3		●	●					●	●							●							
Medium Cut	DCMT11T312-HM	1.2	0.6-3.0	0.12-0.36								○	○	○													

● Ex stock ○ On demand
 YBC152F, YBC252F, YBM153F, YBM253F available

- HC¹ Coated carbide
- HT Uncoated cermet
- HC² Coated cermet
- HW Uncoated carbide

B

Milling

Tool holder						
SDACR/L	SDJCR/L	SDNCN	SDACR/L-SC	SDHCR/L-SC	SDJCR/L-SC	SDNCN-SC
Kr: 90°	Kr: 93°	Kr: 62°30'	Kr: 90°	Kr: 107°30'	Kr: 93°	Kr: 62°30'
A271	A272	A273	A308	A309	A310	A311

C

Drilling

S***-SDQCR/L	A***-SDUCR/L	S***-SDZCR/L	E***-SDQCR/L
Kr: 107°30'	Kr: 93°	Kr: 85°	Kr: 107°30'
A336	A337	A338	A357

D

Technical Information

E

Index



Turning inserts

- Ideal machining conditions
- ⊗ Normal machining conditions
- ⊗ Unfavourable machining conditions

DC**	L	I.C	S	d
07 02	7.8	6.35	2.38	2.8
11 T3	11.6	9.525	3.97	4.4

DC** positive insert				HC ¹ (CVD)								HC ¹ (PVD)			HT	HC ²	HW											
				P	●	●	●	●	●	●	●	●	●	●	●	●												
				M					●	⊗			●	●	●	●	●	●										
				K								●	●	●	●													
				N										●	●					●	●							
				S												●	●	●	●	●	●							
				H																								
ISO	r	a _p	f	YBC103	YB6315	YBC152	YBC203	YBC252	YBC352	YBM153	YBM253	YBD102	YB7315	YBD152	YBD152C	YBG101	YBG102	YBG105	YBG205	YB9320	YPD201	YBS103	YNG151	YNT251	YNG151C	YD101	YD201	
Flat 	DCMW11T304	0.4	0.5-5.0	0.05-0.20								○																
	DCMW11T308	0.8	0.4-5.0	0.1-0.4								○																
Medium Cut																												
HR 	DCMT11T304-HR	0.4	1-4	0.1-0.3			○	●				●	●															
	DCMT11T308-HR	0.8	1-4	0.12-0.35			●	●				●	●															
	DCMT11T312-HR	1.2	1.2-4.0	0.14-0.42			○	●				○																
Roughing																												
LC 	DCGX070201-LC	0.1	0.3-4.0	0.05-0.10																								●
	DCGX070202-LC	0.2	0.3-4.0	0.05-0.15													●											●
	DCGX070204-LC	0.4	0.5-4.0	0.1-0.3													●											●
	DCGX11T302-LC	0.2	0.3-5.5	0.05-0.15													●											●
	DCGX11T304-LC	0.4	0.5-5.5	0.1-0.3													●											●
	DCGX11T308-LC	0.8	0.5-5.5	0.15-0.60													●											●

● Ex stock ○ On demand
YBC152F, YBC252F, YBM153F, YBM253F available

HC¹ Coated carbide
HT Uncoated cermet
HC² Coated cermet
HW Uncoated carbide

Tool holder						
SDACR/L	SDJCR/L	SDNCN	SDACR/L-SC	SDHCR/L-SC	SDJCR/L-SC	SDNCN-SC
Kr: 90°	Kr: 93°	Kr: 62°30'	Kr: 90°	Kr: 107°30'	Kr: 93°	Kr: 62°30'
A271	A272	A273	A308	A309	A310	A311
S***-SDQCR/L	A***-SDUCR/L	S***-SDZCR/L	E***-SDQCR/L			
Kr: 107°30'	Kr: 93°	Kr: 85°	Kr: 107°30'			
A336	A337	A338	A357			

System code > A48

Grade selection > A42

Technical info > A501

Cutting data > A366



General turning Positive inserts

A

Turning

- Ideal machining conditions
- ⊗ Normal machining conditions
- ⊗ Unfavourable machining conditions

DCGX	L	I.C	S	d
07 02	7.8	6.35	2.38	2.8
11 T3	11.6	9.525	3.97	4.4

Turning inserts

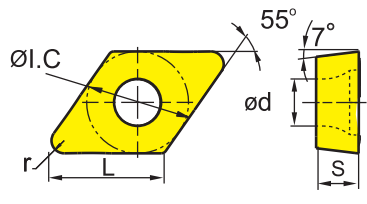

DC** positive insert		HC ¹ (CVD)					HC ¹ (PVD)			HT	HC ²	HW
P	● ● ● ● ● ●	● ● ● ● ● ●	● ● ● ● ● ●	● ● ● ● ● ●	● ● ● ● ● ●	● ● ● ● ● ●	● ● ● ● ● ●	● ● ● ● ● ●	● ● ● ● ● ●	● ● ● ● ● ●	● ● ● ● ● ●	
M				● ● ● ● ● ●	● ● ● ● ● ●	● ● ● ● ● ●	● ● ● ● ● ●	● ● ● ● ● ●	● ● ● ● ● ●	● ● ● ● ● ●	● ● ● ● ● ●	
K					● ● ● ● ● ●	● ● ● ● ● ●	● ● ● ● ● ●	● ● ● ● ● ●	● ● ● ● ● ●	● ● ● ● ● ●	● ● ● ● ● ●	
N							● ● ● ● ● ●	● ● ● ● ● ●	● ● ● ● ● ●	● ● ● ● ● ●	● ● ● ● ● ●	
S							● ● ● ● ● ●	● ● ● ● ● ●	● ● ● ● ● ●	● ● ● ● ● ●	● ● ● ● ● ●	
H												

B

Milling

	ISO	r	a _p	f	YBC103	YB6315	YBC152	YBC203	YBC252	YBC352	YBM153	YBM253	YBD102	YB7315	YBD152	YBD152C	YBG101	YBG102	YBG105	YBG205	YB9320	YPD201	YBS103	YNG151	YNT251	YNG151C	YD101	YD201
LH	DCGX070202-LH	0.2	0.3-4.0	0.05-0.15														●									●	
	DCGX070204-LH	0.4	0.5-4.0	0.1-0.3														●									●	
Alum Machining	DCGX070208-LH	0.8	0.5-4.0	0.15-0.60														○									●	
	DCGX11T302-LH	0.2	0.3-5.5	0.05-0.15														●									●	
	DCGX11T304-LH	0.4	0.5-5.5	0.1-0.3														●									●	
	DCGX11T308-LH	0.8	0.5-5.5	0.15-0.60														●									●	

● Ex stock ○ On demand

HC¹ Coated carbide
HT Uncoated cermet
HC² Coated cermet
HW Uncoated carbide

C

Drilling

Tool holder						
SDACR/L	SDJCR/L	SDNCN	SDACR/L-SC	SDHCR/L-SC	SDJCR/L-SC	SDNCN-SC
Kr: 90°	Kr: 93°	Kr: 62°30'	Kr: 90°	Kr: 107°30'	Kr: 93°	Kr: 62°30'
A271	A272	A273	A308	A309	A310	A311

D

Technical Information

S***-SDQCR/L	A***-SDUCR/L	S***-SDZCR/L	E***-SDQCR/L
Kr: 107°30'	Kr: 93°	Kr: 85°	Kr: 107°30'
A336	A337	A338	A357

E

Index



- Ideal machining conditions
- ⊗ Normal machining conditions
- ⊗ Unfavourable machining conditions

DPGT	L	I.C	S	d
07 02	7.8	6.35	2.38	2.8
11 T3	11.6	9.525	3.97	4.4

Turning inserts

DP** positive insert				HC ¹ (CVD)								HC ¹ (PVD)			HT	HC ²	HW															
				P	●	●	●	●	●	⊗				●	⊗	●																
				M						●	⊗			●	●	⊗	⊗	●														
				K																												
				N										●	●					●	⊗											
				S												●	●	⊗	⊗	●	⊗											
				H																												
ISO				r	a _p	f	YBC103	YB6315	YBC152	YBC203	YBC252	YBC352	YBM153	YBM253	YBD102	YB7315	YBD152	YBD152C	YBG101	YBG102	YBG105	YBG205	YB9320	YPD201	YBS103	YNG151	YNT251	YNG151C	YD101	YD201		
SF 	DPGT070202-SF	0.2	0.05-2.00	0.05-0.15																						○	●					
	DPGT070204-SF	0.4	0.05-2.00	0.05-0.30																							●	●				
	DPGT11T304-SF	0.4	0.05-2.00	0.1-0.3																							●	●				
	DPGT11T308-SF	0.8	0.05-2.00	0.1-0.4																							○	○				
Finishing																																

● Ex stock ○ On demand

HC¹ Coated carbide
 HT Uncoated cermet
 HC² Coated cermet
 HW Uncoated carbide

Tool holder		
S***-SDQPR/L	S***-SDUPR/L	C***-SDQPR/L
Kr: 107°30'	Kr: 93°	Kr: 107°30'
A349	A350	A356

System code > A48

Grade selection > A42

Technical info > A501

Cutting data > A366



A

Turning

B

Milling

C

Drilling

D

Technical Information



E

Index

RC**	L	I.C	S	d
08 03	8	8	3.18	3.36
10 T3	10	10	3.97	3.6
12 04	12	12	4.76	44.4
16 06	16	16	6.35	5.5
20 06	20	20	6.35	6.5
25 07	25	25	7.94	7.7

- Ideal machining conditions
- ⊗ Normal machining conditions
- ⊗ Unfavourable machining conditions

Turning inserts

RC** positive insert				HC ¹ (CVD)								HC ¹ (PVD)				HT	HC ²	HW									
ISO	a _p	f	RC** positive insert								HC ¹ (PVD)				HT	HC ²	HW										
			YBC103	YB6315	YBC152	YBC203	YBC252	YBC352	YBM153	YBM253	YBD102	YB7315	YBD152	YBD152C	YBG101	YBG102	YBG105	YBG205	YB9320	YPD201	YBS103	YNG151	YNT251	YNG151C	YD101	YD201	
Basic 	RCMT0803MO	0.5-3.0	0.1-0.4					●																			
	RCMT10T3MO	0.5-4.0	0.1-0.5					○																			
	RCMT1204MO	0.8-5.0	0.1-0.6					○	●																		
	RCMT1606MO	1-6	0.1-0.8					●	●		○	●															
	RCMT2006MO	1.2-8.0	0.1-1.0					○	●																		
LH 	RCGX0803MO-LH	1-4	0.2-0.5																							●	
	RCGX1204MO-LH	1.2-5.0	0.2-0.6																							●	
Alum Machining																											

● Ex stock ○ On demand
 YBC152F, YBC252F, YBM153F, YBM253F available

HC¹ Coated carbide
 HT Uncoated cermet
 HC² Coated cermet
 HW Uncoated carbide

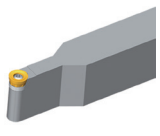
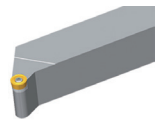
Tool holder	
SRDCN	SRGCR/L
	
A288	A289

System code > A48



Grade selection > A42

Technical info > A501

Cutting data > A366





RCMX	L	I.C	S	d
08 03	8	8	3.18	3.36
10 03	10	10	3.18	4.4
12 04	12	12	4.76	4.4
16 06	16	16	6.35	5.5
20 06	20	20	6.35	6.5
25 07	25	25	7.94	7.2
32 09	32	32	9.52	10.2

-  Ideal machining conditions
-  Normal machining conditions
-  Unfavourable machining conditions

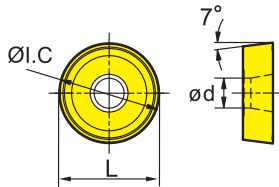
Turning inserts



RC** positive insert			HC ¹ (CVD)										HC ¹ (PVD)			HT	HC ²	HW								
ISO	a _p	f	P	M	K	N	S	H																		
			YBC103	YB6315	YBC152	YBC203	YBC252	YBC352	YBM153	YBM253	YBD102	YB7315	YBD152	YBD152C	YBG101	YBG102	YBG105	YBG205	YB9320	YPD201	YBS103	YNG151	YNT251	YNG151C	YD101	YD201
Basic  Light Roughing	RCMX0803MO	0.5-4.0	0.1-0.5																							
	RCMX1003MO	0.5-5.0	0.1-0.6																							
	RCMX1204MO	1-6	0.1-0.8		○	●																				
	RCMX1606MO	1-7	0.2-0.9		○	●		○									○									
	RCMX2006MO	1-9	0.2-1.0		●	●					●															
	RCMX2507MO	2-10	0.25-1.20			●																				
	RCMX3209MO	2-13	0.25-1.40		○	●																				
Basic  Light Roughing	RCMX2507MO-1	2-9	0.1-0.4		○																					
Basic  Light Roughing	RCMX3209MO-PV	3-12	0.1-0.4		○	●																				

● Ex stock ○ On demand
YBC152F, YBC252F, YBM153F, YBM253F available

HC¹ Coated carbide
HT Uncoated cermet
HC² Coated cermet
HW Uncoated carbide



A Turning

B Milling

C Drilling

D Technical Information

E Index





A

Turning

- Ideal machining conditions
- ⊗ Normal machining conditions
- ⊗ Unfavourable machining conditions

SCMT	L	I.C	S	d
09 T3	9.525	9.525	3.97	4.4
12 04	12.7	12.7	4.76	5.56

Turning inserts

SC** positive insert					HC ¹ (CVD)										HC ¹ (PVD)		HT	HC ²	HW											
					P	●	●	●	●	●	●	●	●	●	●	●	●	●	●	●										
					M	●	●	●	●	●	●	●	●	●	●	●	●	●	●	●										
					K	●	●	●	●	●	●	●	●	●	●	●	●	●	●	●										
					N	●	●	●	●	●	●	●	●	●	●	●	●	●	●	●										
					S	●	●	●	●	●	●	●	●	●	●	●	●	●	●	●										
					H	●	●	●	●	●	●	●	●	●	●	●	●	●	●	●										
	ISO	r	a _p	f	YBC103	YB6315	YBC152	YBC203	YBC252	YBC352	YBM153	YBM253	YBD102	YB7315	YBD152	YBD152C	YBG101	YBG102	YBG105	YBG205	YB9320	YPD201	YBS103	YNG151	YNT251	YNG151C	YD101	YD201		
AHF  Finishing	SCMT09T304-AHF	0.4	0.5-3.0	0.05-0.30	●																			○						
	SCMT09T308-AHF	0.8	0.5-3.0	0.05-0.40	●																				●					
EF  Finishing	SCMT09T302-EF	0.2	0.07-2.00	0.05-0.15																●										
	SCMT09T304-EF	0.4	0.11-2.00	0.06-0.23																●										
	SCMT09T308-EF	0.8	0.15-2.00	0.08-0.30																●										
EM  Finishing	SCMT09T304-EM	0.4	0.25-3.00	0.08-0.23							○	○							●											
	SCMT09T308-EM	0.8	0.5-3.0	0.1-0.3							●	●							●											
	SCMT120404-EM	0.4	0.3-3.6	0.09-0.27							○	○							●											
	SCMT120408-EM	0.8	0.6-3.6	0.12-0.36							○	○							●											
	SCMT120412-EM	1.2	0.72-3.60	0.14-0.43									○						●											
XF  Finishing	SCMT09T304-XF	0.4	0.5-2.0	0.08-0.25	●																									
	SCMT09T308-XF	0.8	0.5-2.0	0.08-0.30	●							○																		

● Ex stock ○ On demand
 YBC152F, YBC252F, YBM153F, YBM253F available

HC¹ Coated carbide
 HT Uncoated cermet
 HC² Coated cermet
 HW Uncoated carbide

B

Milling

C



Drilling

D

Technical Information

E

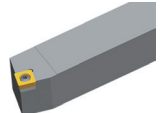
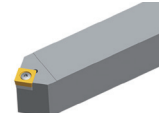
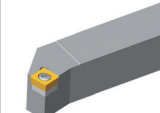
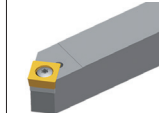
Index

Tool holder				
SSBCR/L	SSDCN	SSKCR/L	SSSCR/L	S***-SSKCR/L
Kr: 75°	Kr: 45°	Kr: 75°	Kr: 45°	Kr: 75°
				
A279	A280	A281	A282	A339



Turning inserts

- Ideal machining conditions
- Normal machining conditions
- Unfavourable machining conditions

SCMT	L	I.C	S	d
09 T3	9.525	9.525	3.97	4.4
12 04	12.7	12.7	4.76	5.56

SC** positive insert				HC ¹ (CVD)								HC ¹ (PVD)			HT	HC ²	HW																	
				P	M	K	N	S	H																									
				●	●	●	●	●	●	●	●	●	●	●	●	●	●	●																
ISO				r	a _p	f	YBC103	YB6315	YBC152	YBC203	YBC252	YBC352	YBM153	YBM253	YBD102	YB7315	YBD152	YBD152C	YBG101	YBG102	YBG105	YBG205	YB9320	YPD201	YBS103	YNG151	YNT251	YNG151C	YD101	YD201				
 Finishing	SCMT09T302-HF	0.2	0.15-2.00	0.05-0.15																														
	SCMT09T304-HF	0.4	0.11-2.00	0.05-0.23																														
	SCMT09T308-HF	0.8	0.15-2.00	0.05-0.30				●	●																									
 Medium Cut	SCMT09T304-HM	0.4	0.25-3.00	0.08-0.23			●	●																										
	SCMT09T308-HM	0.8	0.5-3.0	0.1-0.3			●	●																										
	SCMT120404-HM	0.4	0.3-3.6	0.09-0.27			●	●																										
	SCMT120408-HM	0.8	0.6-3.6	0.12-0.36			○	●																										
 Medium Cut	SCMT09T304-XM	0.4	1-2.5	0.15-0.3	○	○																												
	SCMT09T308-XM	0.8	1-2.5	0.15-0.35	○	○																												
	SCMT09T312-XM	1.2	1-2.5	0.15-0.4	○	○																												
	SCMT120408-XM	0.8	1-3.0	0.15-0.35	○	○																												
SCMT120412-XM	1.2	1-3.0	0.15-0.4	○	○																													

● Ex stock ○ On demand
 YBC152F, YBC252F, YBM153F, YBM253F available

HC¹ Coated carbide
 HT Uncoated cermet
 HC² Coated cermet
 HW Uncoated carbide

Tool holder				
SSBCR/L	SSDCN	SSKCR/L	SSSCR/L	S***-SSKCR/L
Kr: 75°	Kr: 45°	Kr: 75°	Kr: 45°	Kr: 75°
A279	A280	A281	A282	A339

System code > A48

Grade selection > A42

Technical info > A501

Cutting data > A366



A Turning
B Milling
C Drilling
D Technical Information
E Index

A

Turning

- Ideal machining conditions
- ⊗ Normal machining conditions
- ⊗ Unfavourable machining conditions

SC**	L	I.C	S	d
09 T3	9.525	9.525	3.97	4.4
12 04	12.7	12.7	4.76	5.55.56

Turning inserts

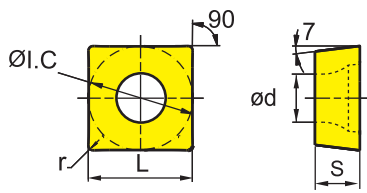

SC** positive insert					HC ¹ (CVD)										HC ¹ (PVD)			HT	HC ²	HW									
					P	●	●	●	⊗	⊗	⊗					●	⊗	●	●	⊗									
					M				●	⊗		●	●	⊗	⊗	●	●	●											
					K				●	⊗	⊗	⊗																	
					N							●	●						●	⊗									
					S							●	●	⊗	⊗	⊗	●		●	⊗									
					H																								
ISO		r	a _p	f	YBC103	YB6315	YBC152	YBC203	YBC252	YBC352	YBM153	YBM253	YBD102	YB7315	YBD152	YBD152C	YBG101	YBG102	YBG105	YBG205	YB9320	YPD201	YBS103	YNG151	YNT251	YNG151C	YD101	YD201	
HR 	SCMT09T304-HR	0.4	0.2-4.0	0.05-0.40			○	●							○														
	SCMT09T308-HR	0.8	1-4	0.12-0.35			●	●					●		●														
	SCMT09T312-HR	1.2	1.2-4.0	0.14-0.42					○																				
	SCMT120404-HR	0.4	0.5-4.0	0.05-0.50			○	○																					
	SCMT120408-HR	0.8	1.2-4.8	0.14-0.42			●	●					●		●														
Roughing	SCMT120412-HR	1.2	1.44-4.80	0.17-0.50			●	●					●		○														
	LC 	SCGX09T304-LC	0.4	0.5-5.0	0.1-0.5																							●	
Alum Machining	SCGX09T308-LC	0.8	0.5-5.0	0.15-0.60																								●	
	SCGX120408-LC	0.8	1-7	0.15-0.60													●											●	

● Ex stock ○ On demand
 YBC152F, YBC252F, YBM153F, YBM253F available

HC¹ Coated carbide
 HT Uncoated cermet
 HC² Coated cermet
 HW Uncoated carbide

B

Milling

C

Drilling

D

Technical Information

E

Index

Tool holder				
SSBCR/L	SSDCN	SSKCR/L	SSSCR/L	S***-SSKCR/L
Kr: 75°	Kr: 45°	Kr: 75°	Kr: 45°	Kr: 75°
A279	A280	A281	A282	A339



- Ideal machining conditions
- Normal machining conditions
- Unfavourable machining conditions

SCGX	L	I.C	S	d
09 T3	9.525	9.525	3.97	4.4
12 04	12.7	12.7	4.76	5.56

Turning inserts

SC** positive insert				HC ¹ (CVD)								HC ¹ (PVD)			HT	HC ²	HW										
				P	●	●	●	●	●	●	●	●	●	●	●	●											
				M										●	●	●	●	●									
				K																							
				N										●	●				●	●							
				S																●	●						
				H																							
ISO	r	a _p	f	YBC103	YB6315	YBC152	YBC203	YBC252	YBC352	YBM153	YBM253	YBD102	YB7315	YBD152	YBD152C	YBG101	YBG102	YBG105	YBG205	YB9320	YPD201	YBS103	YNG151	YNT251	YNG151C	YD101	YD201
LH Alum Machining	SCGX09T302-LH	0.2	0.5-4.0	0.05-0.15												○											●
	SCGX09T304-LH	0.4	0.5-4.0	0.1-0.3																							●
	SCGX09T308-LH	0.8	0.5-4.0	0.15-0.60																							●
	SCGX120408-LH	0.8	0.5-5.0	0.15-0.60												○											●

● Ex stock ○ On demand

HC¹ Coated carbide
 HT Uncoated cermet
 HC² Coated cermet
 HW Uncoated carbide

Tool holder				
SSBCR/L	SSDCN	SSKCR/L	SSSCR/L	S***-SSKCR/L
Kr: 75°	Kr: 45°	Kr: 75°	Kr: 45°	Kr: 75°
A279	A280	A281	A282	A339

System code > A48

Grade selection > A42

Technical info > A501

Cutting data > A366



A

Turning

- Ideal machining conditions
- ⊗ Normal machining conditions
- ⊗ Unfavourable machining conditions

SPMW	L	I.C	S	d
09 T3	9.525	9.525	3.97	4.4
12 04	12.7	12.7	4.76	5.56

Turning inserts

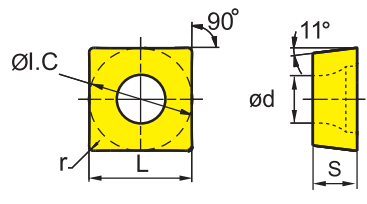

SP** positive insert				HC ¹ (CVD)								HC ¹ (PVD)		HT	HC ²	HW														
				P	M	K	N	S	H																					
ISO				r	a _p	f	YBC103	YB6315	YBC152	YBC203	YBC252	YBC352	YBM153	YBM253	YBD102	YB7315	YBD152	YBD152C	YBG101	YBG102	YBG105	YBG205	YB9320	YPD201	YBS103	YNG151	YNT251	YNG151C	YD101	YD201
Flat 	SPMW09T304	0.4	0.5-4.0	0.1-0.4																										
	SPMW09T308	0.8	0.5-4.0	0.2-0.4																										
	SPMW120408	0.8	1-6	0.3-0.6																										

● Ex stock ○ On demand

HC¹ Coated carbide
 HT Uncoated cermet
 HC² Coated cermet
 HW Uncoated carbide

B

Milling

C

Drilling

D

Technical Information

E

Index



- Ideal machining conditions
- ⊗ Normal machining conditions
- ⊗ Unfavourable machining conditions

TBGH	L	I.C	S	d
06 01	6.87	3.97	1.59	2.2

Turning inserts

TB** positive insert				HC ¹ (CVD)								HC ¹ (PVD)			HT	HC ²	HW										
				P	M	K	N	S	H																		
ISO	r	a _p	f	YBC103	YB6315	YBC152	YBC203	YBC252	YBC352	YBM153	YBM253	YBD102	YB7315	YBD152	YBD152C	YBG101	YBG102	YBG105	YBG205	YB9320	YPD201	YBS103	YNG151	YNT251	YNG151C	YD101	YD201
	TBGH060102L	0.2	0.5-3.5	0.05-0.40												●							●				
	TBGH060104L	0.4	0.5-3.5	0.05-0.40													○							●			

● Ex stock ○ On demand

HC¹ Coated carbide
 HT Uncoated cermet
 HC² Coated cermet
 HW Uncoated carbide

A

Turning

B

Milling

C

Drilling

D

Technical Information

E

Index

System code > A48

Grade selection > A42

Technical info > A501

Cutting data > A366



A

Turning

B

Milling

C

Drilling

D

Technical Information

E

Index

- Ideal machining conditions
- ⊗ Normal machining conditions
- ⊗ Unfavourable machining conditions

TCGT	L	I.C	S	d
06 T1	6.87	3.97	1.98	2.2
09 02	9.63	5.56	2.38	2.5
11 03	11	6.35	3.18	2.8

Turning inserts

TC** positive insert				HC ¹ (CVD)										HC ¹ (PVD)			HT	HC ²	HW											
	P	M	K	N	S	H	YBC103	YB6315	YBC152	YBC203	YBC252	YBC352	YBM153	YBM253	YBD102	YB7315	YBD152	YBD152C	YBG101	YBG102	YBG105	YBG205	YB9320	YPD201	YBS103	YNG151	YNT251	YNG151C	YD101	YD201
	ISO	r	a _p	f																										
		TCGT06T102-SF	0.2	0.05-2.00	0.05-0.15																									
		TCGT090202-SF	0.2	0.05-2.00	0.05-0.15																									
		TCGT090204-SF	0.4	0.05-2.00	0.1-0.3																									
		TCGT090208-SF	0.8	0.05-2.00	0.10-0.35																									
TCGT110302-SF		0.2	0.05-2.00	0.05-0.15																										
TCGT110304-SF		0.4	0.05-2.00	0.1-0.3																										
TCGT110308-SF		0.8	0.05-2.00	0.10-0.35																										

● Ex stock ○ On demand

HC¹ Coated carbide
 HT Uncoated cermet
 HC² Coated cermet
 HW Uncoated carbide

Tool holder	
STGCR/L Kr: 91°	E***-STFCR/L Kr: 90°
A285	A361

System code > A48

Grade selection > A42

Technical info > A501

Cutting data > A366



TCMT	L	I.C	S	d
09 02	9.63	5.56	2.38	2.5
11 02	11	6.35	2.38	2.8
16 T3	16.5	9.525	3.97	4.4

- Ideal machining conditions
- ⊗ Normal machining conditions
- ⊗ Unfavourable machining conditions

Turning inserts

TC** positive insert				HC ¹ (CVD)								HC ¹ (PVD)			HT	HC ²	HW													
				P	M	K	N	S	H																					
ISO	r	a _p	f	YBC103	YB6315	YBC152	YBC203	YBC252	YBC352	YBM153	YBM253	YBD102	YBD315	YBD152	YBD152C	YBG101	YBG102	YBG105	YBG205	YB9320	YPD201	YBS103	YNG151	YNT251	YNG151C	YD101	YD201			
AHF Finishing	TCMT110204-AHF	0.4	0.2-2.5	0.05-0.30	●	●	●	●	●																					
	TCMT110208-AHF	0.8	0.2-2.5	0.1-0.4	●	●	●	●	●																					
	TCMT16T304-AHF	0.4	0.5-3.0	0.05-0.30	●	●	●	●	●																					
	TCMT16T308-AHF	0.8	0.5-3.5	0.1-0.4	●	●	●	●	●																					
HF Finishing	TCMT090202-HF	0.2	0.06-1.70	0.03-0.13		○	●																○							
	TCMT090204-HF	0.4	0.1-1.7	0.05-0.19		○	●																							
	TCMT090208-HF	0.8	0.15-1.70	0.10-0.25			○	●																						
	TCMT110202-HF	0.2	0.08-2.00	0.05-0.20				●																						
	TCMT110204-HF	0.4	0.1-2.0	0.05-0.30		○	●						○																	
	TCMT110208-HF	0.8	0.1-2.0	0.05-0.35		●	●					●																		
	TCMT16T304-HF	0.4	0.11-2.00	0.05-0.23		○	●																							
XF Finishing	TCMT090202-XF	0.2	0.5-1.5	0.08-0.15				○																						
	TCMT090204-XF	0.4	0.5-1.5	0.08-0.20	●																									
	TCMT110202-XF	0.2	0.5-2.0	0.08-0.15				○																						
	TCMT110204-XF	0.4	0.5-2.0	0.08-0.20	●																									
	TCMT110208-XF	0.8	0.5-2.5	0.08-0.25	●																									
	TCMT16T304-XF	0.4	0.5-2.5	0.08-0.20	●																									
TCMT16T308-XF	0.8	0.5-2.5	0.08-0.25	●																										

● Ex stock ○ On demand
 YBC152F, YBC252F, YBM153F, YBM253F available

HC¹ Coated carbide
 HT Uncoated cermet
 HC² Coated cermet
 HW Uncoated carbide

Tool holder					
STACR/L	STFCR/L	STGCR/L	STTCR/L	S***-STFCR/L	E***-STFCR/L
Kr: 90°	Kr: 91°	Kr: 91°	Kr: 60°	Kr: 91°	Kr: 90°
A283	A284	A285	A286	A341	A361

A

Turning

B

Milling

C

Drilling

D

Technical Information

E

Index

- Ideal machining conditions
- ● Normal machining conditions
- ● ● Unfavourable machining conditions

TCMT	L	I.C	S	d
09 02	9.63	5.56	2.38	2.5
11 02	11	6.35	2.38	2.8
16 T3	16.5	9.525	3.97	4.4

Turning inserts

TC** positive insert				HC ¹ (CVD)								HC ¹ (PVD)		HT	HC ²	HW														
	P	M	K	N	S	H	YBC103	YB6315	YBC152	YBC203	YBC252	YBC352	YBM153	YBM253	YBD102	YB7315	YBD152	YBD152C	YBG101	YBG102	YBG105	YBG205	YB9320	YPD201	YBS103	YNG151	YNT251	YNG151C	YD101	YD201
	ISO	r	a _p	f																										
	 Finishing	TCMT090202-EF	0.2	0.06-1.70	0.03-0.13																									
		TCMT090204-EF	0.4	0.1-1.7	0.05-0.19																									
		TCMT110202-EF	0.2	0.2-2.0	0.05-0.13																									
		TCMT110204-EF	0.4	0.2-2.0	0.05-0.20																									
TCMT16T304-EF		0.4	0.3-3.0	0.05-0.23																										
TCMT16T308-EF		0.8	0.3-3.0	0.1-0.4																										
 Medium Cut	TCMT090204-EM	0.4	0.19-2.25	0.06-0.17																										
	TCMT110204-EM	0.4	0.2-2.7	0.05-0.30																										
	TCMT110208-EM	0.8	0.8-2.7	0.08-0.30																										
	TCMT16T304-EM	0.4	0.25-3.00	0.08-0.23																										
	TCMT16T308-EM	0.8	0.5-3.0	0.1-0.3																										
 Medium Cut	TCMT16T304-XM	0.4	1-3.0	0.15-0.3	○	○																								
	TCMT16T308-XM	0.8	1-3.0	0.15-0.35	○	○																								
	TCMT16T312-XM	1.2	1-3.0	0.15-0.4	○	○																								

● Ex stock ○ On demand
 YBC152F, YBC252F, YBM153F, YBM253F available

HC¹ Coated carbide
 HT Uncoated cermet
 HC² Coated cermet
 HW Uncoated carbide

Tool holder

STACR/L	STFCR/L	STGCR/L	STTCR/L	S***-STFCR/L	E***-STFCR/L
Kr: 90°	Kr: 91°	Kr: 91°	Kr: 60°	Kr: 91°	Kr: 90°
A283	A284	A285	A286	A341	A361

System code > A48

Grade selection > A42

Technical info > A501

Cutting data > A366

TC**	L	I.C	S	d
09 02	9.63	5.56	2.38	2.5
11 02	11	6.35	2.38	2.8
16 T3	16.5	9.525	3.97	4.4
22 04	22	12.7	4.76	5.5

- Ideal machining conditions
- ⊗ Normal machining conditions
- ⊗ Unfavourable machining conditions

Turning inserts

TC** positive insert					HC ¹ (CVD)								HC ¹ (PVD)			HT	HC ²	HW
					P	●	●	●	●	●	●	●	●	●	●	●	●	●
					M	●	●	●	●	●	●	●	●	●	●	●	●	●
					K	●	●	●	●	●	●	●	●	●	●	●		
					N	●	●	●	●	●	●	●	●	●	●	●		
					S	●	●	●	●	●	●	●	●	●	●	●		
					H	●	●	●	●	●	●	●	●	●	●	●		
ISO	r	a _p	f		YBC103	YBC103	YBC103	YBC103	YBC103	YBC103	YBC103	YBC103	YBC103	YBC103	YBC103	YBC103		
Flat Medium Cut	TCMW16T308				0.8	0.5-5.0	0.05-0.60											
	HM Medium Cut	TCMT090204-HM				0.4	0.19-2.25	0.06-0.17	●	●	●	●						
TCMT090208-HM				0.8	0.38-2.25	0.08-0.23	○	○			○							
TCMT110204-HM				0.4	0.2-2.7	0.07-0.20	●	●	●	●								
TCMT110208-HM				0.8	0.5-2.7	0.1-0.3	●	●			●							
TCMT16T304-HM				0.4	0.25-3.00	0.08-0.23	●	●	●	●								
TCMT16T308-HM				0.8	0.5-3.0	0.1-0.3	●	●	●	●								
TCMT16T312-HM				1.2	0.6-3.0	0.12-0.36	○	●										
HR Roughing	TCMT090204-HR				0.4	0.5-3.0	0.1-0.3			○								
	TCMT090208-HR				0.8	0.5-3.5	0.08-0.50			○								
	TCMT110204-HR				0.4	0.5-3.0	0.1-0.4		●									
	TCMT110208-HR				0.8	1-4	0.1-0.5		●									
	TCMT16T304-HR				0.4	0.5-4.0	0.1-0.4		●	●								
	TCMT16T308-HR				0.8	1-4	0.12-0.35		●	●	●							
	TCMT16T312-HR				1.2	1.2-4.0	0.14-0.42	○		○	●							
TCMT220408-HR				0.8	1.2-4.8	0.14-0.42	○	●		●								

● Ex stock ○ On demand
YBC152F, YBC252F, YBM153F, YBM253F available

HC¹ Coated carbide
HT Uncoated cermet
HC² Coated cermet
HW Uncoated carbide

Tool holder					
STACR/L	STFCR/L	STGCR/L	STTCR/L	S***-STFCR/L	E***-STFCR/L
Kr: 90°	Kr: 91°	Kr: 91°	Kr: 60°	Kr: 91°	Kr: 90°
A283	A284	A285	A286	A341	A361

System code > A48

Grade selection > A42

Technical info > A501

Cutting data > A366



A

Turning

B

Milling

C

Drilling

D

Technical Information

E

Index

A

Turning

- Ideal machining conditions
- ⊗ Normal machining conditions
- ⊗ Unfavourable machining conditions

TCMT	L	I.C	S	d
22 04	22	12.7	4.76	5.5

Turning inserts

TC** positive insert				HC ¹ (CVD)								HC ¹ (PVD)		HT	HC ²	HW											
	P	●●●●	⊗⊗⊗									⊗⊗	●														
	M			●	⊗							●●	⊗⊗	●													
	K																										
	N											●●			●●												
	S											●●	⊗⊗		●●												
	H																										
ISO	r	a _p	f	YBC103	YB6315	YBC152	YBC203	YBC252	YBC352	YBM153	YBM253	YBD102	YB7315	YBD152	YBD152C	YBG101	YBG102	YBG105	YBG205	YB9320	YPD201	YBS103	YNG151	YNT251	YNG151C	YD101	YD201
Basic	TCMT220408	0.8	1.2-4.8	0.14-0.42							●																

● Ex stock ○ On demand

HC¹ Coated carbide
 HT Uncoated cermet
 HC² Coated cermet
 HW Uncoated carbide

B

Milling

C

Drilling

D

Technical Information

E

Index



TCGX	L	I.C	S	d
09 02	9.63	5.56	2.38	2.5
11 02	11	6.35	2.38	2.8
16 T3	16.5	9.525	3.97	4.4

- Ideal machining conditions
- ⊗ Normal machining conditions
- ⊗ Unfavourable machining conditions

Turning inserts

TC** positive insert				HC ¹ (CVD)								HC ¹ (PVD)		HT	HC ²	HW												
				P	●	●	●	●	⊗	⊗																		
				M					●	●	●	●	●	●	●													
				K																								
				N						●	●				●	⊗												
				S						●	●	●	●	●	●	⊗												
				H																								
ISO	r	a _p	f	YBC103	YB6315	YBC152	YBC203	YBC252	YBC352	YBM153	YBM253	YBD102	YB7315	YBD152	YBD152C	YBG101	YBG102	YBG105	YBG205	YB9320	YPD201	YBS103	YNG151	YNT251	YNG151C	YD101	YD201	
 Alum Machining	TCGX090202-LC	0.2	0.3-4.0	0.05-0.15												●												●
	TCGX090204-LC	0.4	0.5-4.0	0.1-0.3													●											●
	TCGX110202-LC	0.2	0.3-5.0	0.05-0.15													●											●
	TCGX110204-LC	0.4	0.5-5.0	0.1-0.3													●											●
	TCGX110208-LC	0.8	0.5-5.0	0.15-0.60													●											●
	TCGX16T304-LC	0.4	0.5-7.0	0.1-0.3																								●
	TCGX16T308-LC	0.8	0.5-7.0	0.15-0.60													●											●
 Alum Machining	TCGX090202-LH	0.2	0.3-4.0	0.05-0.15													○										●	
	TCGX090204-LH	0.4	0.5-4.0	0.1-0.3														○										●
	TCGX110202-LH	0.2	0.3-5.0	0.05-0.15														○										●
	TCGX110204-LH	0.4	0.5-5.0	0.1-0.3														●										●
	TCGX110208-LH	0.8	0.5-5.0	0.15-0.60																								●
	TCGX16T302-LH	0.2	0.5-7.0	0.05-0.15														○										●
	TCGX16T304-LH	0.4	0.5-7.0	0.1-0.3														○										●
TCGX16T308-LH	0.8	0.5-7.0	0.15-0.60														○										●	

● Ex stock ○ On demand

HC¹ Coated carbide
 HT Uncoated cermet
 HC² Coated cermet
 HW Uncoated carbide

Tool holder					
STACR/L	STFCR/L	STGCR/L	STTCR/L	S***-STFCR/L	E***-STFCR/L
Kr: 90°	Kr: 91°	Kr: 91°	Kr: 60°	Kr: 91°	Kr: 90°
A283	A284	A285	A286	A341	A361

System code > A48

Grade selection > A42

Technical info > A501

Cutting data > A366



A

Turning

B

Milling

C

Drilling

D

Technical Information

E

Index

A

Turning

- Ideal machining conditions
- ⊗ Normal machining conditions
- ⊗ Unfavourable machining conditions

TPGH	L	I.C	S	d
09 02	9.63	5.56	2.38	2.8
11 03	11	6.35	3.18	3.18

Turning inserts

TP** positive insert				HC ¹ (CVD)										HC ¹ (PVD)		HT	HC ²	HW												
	P	M	K	N	S	H																								
	ISO	r	a _p	f	YBC103	YB6315	YBC152	YBC203	YBC252	YBC352	YBM153	YBM253	YBD102	YB7315	YBD152	YBD152C	YBG101	YBG102	YBG105	YBG205	YB9320	YPD201	YBS103	YNG151	YNT251	YNG151C	YD101	YD201		
	 Super Finishing	TPGH090202L	0.2	0.2-3.0	0.05-0.15													●								●	●			
		TPGH090204L	0.4	0.2-3.0	0.05-0.30														●								●	●		
		TPGH110302L	0.2	0.2-3.5	0.05-0.15														●								●	●		
		TPGH110304L	0.4	0.2-3.5	0.05-0.30														●								●	●		

● Ex stock ○ On demand

HC¹ Coated carbide
 HT Uncoated cermet
 HC² Coated cermet
 HW Uncoated carbide

B

Milling

C

Drilling

D

Technical Information

E

Index

System code > A48

Grade selection > A42

Technical info > A501

Cutting data > A366

Turning inserts

- Ideal machining conditions
- Normal machining conditions
- Unfavourable machining conditions

TPGT	L	I.C	S	d
09 02	9.63	5.56	2.38	2.5
11 03	11	6.35	3.18	2.8

TP** positive insert				HC ¹ (CVD)								HC ¹ (PVD)		HT	HC ²	HW												
				P	●	●	●	●	●	●	●	●	●	●	●	●												
				M						●	●	●	●	●	●	●	●											
				K																								
				N										●	●			●	●									
				S															●	●								
				H																								
ISO	r	a _p	f	YBC103	YB6315	YBC152	YBC203	YBC252	YBC352	YBM153	YBM253	YBD102	YB7315	YBD152	YBD152C	YBG101	YBG102	YBG105	YBG205	YB9320	YPD201	YBS103	YNG151	YNT251	YNG151C	YD101	YD201	
 SF Finishing	TPGT090202-SF	0.2	0.05-2.00	0.05-0.15																								
	TPGT090204-SF	0.4	0.05-2.00	0.05-0.25													○							●	●			
	TPGT090208-SF	0.8	0.05-2.00	0.05-0.35																				●	●			
	TPGT110302-SF	0.2	0.05-2.00	0.05-0.15																				●	●			
	TPGT110304-SF	0.4	0.05-2.00	0.05-0.25																				○	●	●		
	TPGT110308-SF	0.8	0.05-2.00	0.05-0.35																					●	●		

● Ex stock ○ On demand

HC¹ Coated carbide
 HT Uncoated cermet
 HC² Coated cermet
 HW Uncoated carbide

Tool holder		
S***-STUPR/L	C***-STUPR/L	E***-STFPR/L
Kr: 93°	Kr: 93°	Kr: 90°
A351	A360	A362

System code > A48

Grade selection > A42

Technical info > A501

Cutting data > A366



A Turning
B Milling
C Drilling
D Technical Information
E Index

A

Turning

B

Milling

C

Drilling

D

Technical Information

E

Index

- Ideal machining conditions
- ● Normal machining conditions
- ● ● Unfavourable machining conditions

VBMT	L	I.C	S	d
11 02	11	6.35	2.38	2.8
11 03	11	6.35	3.18	2.8
16 04	16.5	9.525	4.76	4.4

Turning inserts

VB** positive insert					HC ¹ (CVD)										HC ¹ (PVD)			HT	HC ²	HW													
					P	M	K	N	S	H																							
ISO					r	a _p	f																										
					YBC103	YB6315	YBC152	YBC203	YBC252	YBC352	YBM153	YBM253	YBD102	YB7315	YBD152	YBD152C	YBG101	YBG102	YBG105	YBG205	YB9320	YPD201	YBS103	YNG151	YNT251	YNG151C	YD101	YD201					
AHF	VBMT160404-AHF				0.4	0.2-3.0	0.05-0.30																										
	VBMT160408-AHF				0.8	0.8-3.5	0.08-0.40																										
Finishing																																	
EF	VBMT110302-EF				0.2	0.06-1.70	0.03-0.13																										
	VBMT110304-EF				0.4	0.1-1.7	0.05-0.19																										
	VBMT110308-EF				0.8	0.13-1.70	0.07-0.26																										
	VBMT160404-EF				0.4	0.1-1.8	0.05-0.20																										
	VBMT160408-EF				0.8	0.14-1.80	0.07-0.27																										
XF	VBMT110202-XF				0.2	0.5-2.0	0.08-0.20																										
	VBMT110204-XF				0.4	0.5-2.0	0.08-0.20																										
	VBMT110302-XF				0.2	0.5-2.0	0.08-0.20																										
	VBMT110304-XF				0.4	0.5-2.0	0.08-0.20																										
	VBMT160404-XF				0.4	0.5-2.5	0.08-0.20																										
	VBMT160408-XF				0.8	0.5-2.5	0.08-0.25																										

● Ex stock ○ On demand
 YBC152F, YBC252F, YBM153F, YBM253F available

HC¹ Coated carbide
 HT Uncoated cermet
 HC² Coated cermet
 HW Uncoated carbide

Tool holder					
SVJBR/L	SVABR/L	SVVBN	S***-SVQBR/L	S***-SVUBR/L	S***-SVXBR/L
Kr: 93°	Kr: 90°	Kr: 72°30'	Kr: 107°30'	Kr: 93°	Kr: 93°
A274	A275	A276	A345	A346	A347



- Ideal machining conditions
- Normal machining conditions
- Unfavourable machining conditions

VB**	L	I.C	S	d
11 02	11	6.35	2.38	2.8
16 04	16.5	9.525	4.76	4.4

Turning inserts

VB** positive insert				HC ¹ (CVD)								HC ¹ (PVD)			HT	HC ²	HW											
				P	M	K	N	S	H																			
ISO	r	a _p	f	YBC103	YB6315	YBC152	YBC203	YBC252	YBC352	YBM153	YBM253	YBD102	YB7315	YBD152	YBD152C	YBG101	YBG102	YBG105	YBG205	YB9320	YPD201	YBS103	YNG151	YNT251	YNG151C	YD101	YD201	
HF 	VBMT110202-HF	0.2	0.2-2.0	0.05-0.15																								
	VBMT110204-HF	0.4	0.2-2.0	0.05-0.35																								
	VBMT110208-HF	0.8	0.2-2.0	0.05-0.40																								
NF 	VBET160404-NF	0.4	0.2-3.0	0.05-0.30													○ ●											
	VBET160408-NF	0.8	0.2-3.0	0.08-0.40														○ ●										

● Ex stock ○ On demand

HC¹ Coated carbide
 HT Uncoated cermet
 HC² Coated cermet
 HW Uncoated carbide

Tool holder					
SVJBR/L	SVABR/L	SVVBN	S***-SVQBR/L	S***-SVUBR/L	S***-SVXBR/L
Kr: 93°	Kr: 90°	Kr: 72°30'	Kr: 107°30'	Kr: 93°	Kr: 93°
A274	A275	A276	A345	A346	A347

A

Turning

- Ideal machining conditions
- ⊗ Normal machining conditions
- ⊗ Unfavourable machining conditions

VBGT	L	I.C	S	d
11 03	11	6.35	3.18	2.8

Turning inserts

VB** positive insert				HC ¹ (CVD)								HC ¹ (PVD)			HT	HC ²	HW											
				P	●	●	●	⊗	⊗	⊗					●	⊗	●											
				M					●	⊗		●	●	⊗	⊗	●	●	●										
				K									●	⊗	⊗	⊗												
				N										●	●					●	⊗							
				S											●	●	⊗	⊗	●	●	⊗							
				H																								
ISO	r	a _p	f	YBC103	YB6315	YBC152	YBC203	YBC252	YBC352	YBM153	YBM253	YBD102	YB7315	YBD152	YBD152C	YBG101	YBG102	YBG105	YBG205	YB9320	YPD201	YBS103	YNG151	YNT251	YNG151C	YD101	YD201	
SF	VBGT110302-SF	0.2	0.05-2.00	0.05-0.15																			○	○	●			
	VBGT110304-SF	0.4	0.05-2.00	0.05-0.20																				○	●			
Finishing																												

● Ex stock ○ On demand

HC¹ Coated carbide
 HT Uncoated cermet
 HC² Coated cermet
 HW Uncoated carbide

B

Milling

C

Drilling

Tool holder			
SVJBR/L	SVABR/L	SVVBN	S***-SVXBR/L
Kr: 93°	Kr: 90°	Kr: 72°30'	Kr: 93°
A274	A275	A276	A347

D

Technical Information

E

Index

System code > A48

Grade selection > A42

Technical info > A501

Cutting data > A366

Turning inserts

- Ideal machining conditions
- ● Normal machining conditions
- ● ● Unfavourable machining conditions

VB**	L	I.C	S	d
11 03	11	6.35	3.18	2.8
16 04	16.5	9.525	4.76	4.4

VB** positive insert				HC ¹ (CVD)								HC ¹ (PVD)			HT	HC ²	HW										
				P	M	K	N	S	H																		
ISO	r	a _p	f	YBC103	YB6315	YBC152	YBC203	YBC252	YBC352	YBM153	YBM253	YBD102	YB7315	YBD152	YBD152C	YBG101	YBG102	YBG105	YBG205	YB9320	YPD201	YBS103	YNG151	YNT251	YNG151C	YD101	YD201
NGF	VBET160408-NGF	0.8	0.2-3.0	0.08-0.30														●									
	VBET160412-NGF	1.2	0.2-3.0	0.1-0.4														●									
Finishing																											
EM	VBMT110304-EM	0.4	0.15-2.00	0.07-0.20						●								●									
	VBMT110308-EM	0.8	0.2-2.0	0.09-0.27		○				●								●									
	VBMT160404-EM	0.4	0.23-2.70	0.07-0.20						●								●									
	VBMT160408-EM	0.8	0.45-2.70	0.09-0.27						●								●									
Medium Cut																											
HM	VBMT160404-HM	0.4	0.23-2.70	0.07-0.20		●	●	●	●																		
	VBMT160408-HM	0.8	0.45-2.70	0.09-0.27		●	●	●	●	●																○	
	VBMT160412-HM	1.2	0.54-2.70	0.11-0.32		●	●																				
Medium Cut																											
XM	VBMT160404-XM	0.4	1-2.5	0.15-0.25	●	○																					
	VBMT160408-XM	0.8	1-2.5	0.15-0.3	●	○																					
	VBMT160412-XM	1.2	1-2.5	0.15-0.35	●	○																					
Medium Cut																											

● Ex stock ○ On demand
 YBC152F, YBC252F, YBM153F, YBM253F available

HC¹ Coated carbide
 HT Uncoated cermet
 HC² Coated cermet
 HW Uncoated carbide

Tool holder					
SVJBR/L	SVABR/L	SVVBN	S***-SVQBR/L	S***-SVUBR/L	S***-SVXBR/L
Kr: 93°	Kr: 90°	Kr: 72°30'	Kr: 107°30'	Kr: 93°	Kr: 93°
A274	A275	A276	A345	A346	A347

System code > A48

Grade selection > A42

Technical info > A501

Cutting data > A366



A

Turning

- Ideal machining conditions
- ⊗ Normal machining conditions
- ⊗ Unfavourable machining conditions

VBMT	L	I.C	S	d
16 04	16.5	9.525	4.76	4.4

Turning inserts

VB** positive insert				HC ¹ (CVD)										HC ¹ (PVD)			HT	HC ²	HW								
				P	●	●	●	●	●	●	●	●	●	●	●	●	●	●	●	●	●	●	●	●	●		
				M															●	●	●	●	●	●	●	●	
				K																							
				N																							
				S																							
				H																							

B

Milling

ISO		r	a _p	f	YBC103	YB6315	YBC152	YBC203	YBC252	YBC352	YBM153	YBM253	YBD102	YB7315	YBD152	YBD152C	YBG101	YBG102	YBG105	YBG205	YB9320	YPD201	YBS103	YNG151	YNT251	YNG151C	YD101	YD201
HR 	VBMT160404-HR	0.4	0.5-3.0	0.1-0.3			●		●																			
	VBMT160408-HR	0.8	0.9-3.6	0.11-0.32			○		●																			
	VBMT160412-HR	1.2	1.08-3.60	0.13-0.38			○		●																			
SNR 	VBMT160408-SNR	0.8	0.5-4.0	0.1-0.3															●				○					
	VBMT160412-SNR	1.2	0.5-4.0	0.3-0.6															●				○	○				

● Ex stock ○ On demand
 YBC152F, YBC252F, YBM153F, YBM253F available

HC¹ Coated carbide
 HT Uncoated cermet
 HC² Coated cermet
 HW Uncoated carbide

C

Drilling

Tool holder					
SVJBR/L	SVABR/L	SVVBN	S***-SVQBR/L	S***-SVUBR/L	S***-SVXBR/L
Kr: 93°	Kr: 90°	Kr: 72°30'	Kr: 107°30'	Kr: 93°	Kr: 93°
A274	A275	A276	A345	A346	A347

D

Technical Information

E

Index

System code > A48

Grade selection > A42

Technical info > A501

Cutting data > A366

Turning inserts

- Ideal machining conditions
- Normal machining conditions
- Unfavourable machining conditions

VC GT	L	I.C	S	d
11 03	11	6.35	3.18	2.8
16 04	16.5	9.525	4.76	4.4

VC** positive insert				HC ¹ (CVD)								HC ¹ (PVD)			HT	HC ²	HW																														
				P	M	K	N	S	H																																						
				<table border="1"> <thead> <tr> <th>ISO</th> <th>r</th> <th>a_p</th> <th>f</th> <th>YBC103</th> <th>YB6315</th> <th>YBC152</th> <th>YBC203</th> <th>YBC252</th> <th>YBC352</th> <th>YBM153</th> <th>YBM253</th> <th>YBD102</th> <th>YB7315</th> <th>YBD152</th> <th>YBD152C</th> <th>YBG101</th> <th>YBG102</th> <th>YBG105</th> <th>YBG205</th> <th>YB9320</th> <th>YPD201</th> <th>YBS103</th> <th>YNG151</th> <th>YNT251</th> <th>YNG151C</th> <th>YD101</th> <th>YD201</th> </tr> </thead> </table>																ISO	r	a _p	f	YBC103	YB6315	YBC152	YBC203	YBC252	YBC352	YBM153	YBM253	YBD102	YB7315	YBD152	YBD152C	YBG101	YBG102	YBG105	YBG205	YB9320	YPD201	YBS103	YNG151	YNT251	YNG151C	YD101	YD201
ISO	r	a _p	f	YBC103	YB6315	YBC152	YBC203	YBC252	YBC352	YBM153	YBM253	YBD102	YB7315	YBD152	YBD152C	YBG101	YBG102	YBG105	YBG205	YB9320	YPD201	YBS103	YNG151	YNT251	YNG151C	YD101	YD201																				
HF	VC GT110304-HF	0.4	0.2-2.0	0.05-0.30																																											
Finishing																																															
NF	VC GT160408-NF	0.8	0.2-2.0	0.1-0.4																																											
Finishing																																															
SF	VC GT110302-SF	0.2	0.05-1.00	0.05-0.15																																											
Finishing	VC GT110304-SF	0.4	0.05-1.00	0.05-0.25																																											
	VC GT160404-SF	0.4	0.05-1.50	0.05-0.25																																											

● Ex stock ○ On demand

HC¹ Coated carbide
 HT Uncoated cermet
 HC² Coated cermet
 HW Uncoated carbide

Tool holder						
SVVCN	SVJCR/L	SVACR/L-SC	SVJCR/L-SC	S***-SVQCR/L	S***-SVUCR/L	C***-SVQCR/L
Kr: 72°30'	Kr: 93°	Kr: 90°	Kr: 93°	Kr: 107°30'	Kr: 93°	Kr: 107°30'
A277	A278	A312	A313	A343	A344	A363

C***-SVUCR/L
Kr: 93°
A364

System code > A48

Grade selection > A42

Technical info > A501

Cutting data > A366



A Turning
B Milling
C Drilling
D Technical Information
E Index

A

Turning

B

Milling

C

Drilling

D

Technical Information

E

Index

- Ideal machining conditions
- ● Normal machining conditions
- ● ● Unfavourable machining conditions

VCGX	L	I.C	S	d
11 03	11	6.35	3.18	2.8
16 04	16.6	9.525	4.76	4.4
22 05	22	12.7	5.56	5.5

Turning/Milling inserts

VC** turning/milling insert				HC ¹ (CVD)										HC ¹ (PVD)		HT	HC ²	HW										
ISO	r	a _p	f	YBC103	YB6315	YBC152	YBC203	YBC252	YBC352	YBM153	YBM253	YBD102	YB7315	YBD152	YBD152C	YBG101	YBG102	YBG105	YBG205	YB9320	YPD201	YBS103	YNG151	YNT251	YNG151C	YD101	YD201	
	P	●●●●●●●●	●●●●●●●●															●●	●●	●●			●●					
	M								●●									●●	●●	●●	●●	●●						
	K											●●	●●	●●														
	N																●●										●●	●●
	S																		●●	●●	●●	●●					●●	●●
	H																											
	LC																●		●								●	
	Alum Machining																●										●	
																○										○	●	

● Ex stock ○ On demand

HC¹ Coated carbide
 HT Uncoated cermet
 HC² Coated cermet
 HW Uncoated carbide

Tool holder						
SVVCN	SVJCR/L	SVACR/L-SC	SVJCR/L-SC	S***-SVQCR/L	S***-SVUCR/L	C***-SVQCR/L
Kr: 72°30'	Kr: 93°	Kr: 90°	Kr: 93°	Kr: 107°30'	Kr: 93°	Kr: 107°30'
A277	A278	A312	A313	A343	A344	A363

C***-SVUCR/L
Kr: 93°
A364



VCGX	L	I.C	S	d
11 02	11	6.35	2.38	2.8
11 03	11	6.35	3.18	2.8
16 04	16.6	9.525	4.76	4.4
22 05	22	12.7	5.56	5.5

- Ideal machining conditions
- Normal machining conditions
- Unfavourable machining conditions

Turning/Milling inserts

VC** turning/milling insert				HC ¹ (CVD)								HC ¹ (PVD)			HT	HC ²	HW																		
ISO	r	a _p	f	P	M	K	N	S	H	YBC103	YB6315	YBC152	YBC203	YBC252	YBC352	YBM153	YBM253	YBD102	YB7315	YBD152	YBD152C	YBG101	YBG102	YBG105	YBG205	YB9320	YPD201	YBS103	YNG151	YNT251	YNG151C	YD101	YD201		
				LH	VCGX110204-LH	0.4	0.5-3.0	0.1-0.3	●●●●●●●●●●																		●								
	VCGX110301-LH	0.1	0.5-3.0	0.05-0.10		●●																												●●	
	VCGX110302-LH	0.2	0.3-3.0	0.05-0.15																				●										●○	
	VCGX110304-LH	0.4	0.5-3.0	0.1-0.3																				●										●○	
	VCGX110308-LH	0.8	0.5-3.0	0.15-0.60																				○										●	
Alum Machining	VCGX160402-LH	0.2	0.5-5.0	0.05-0.10																				●										●	
	VCGX160404-LH	0.4	0.5-5.0	0.1-0.3																				●										●	
	VCGX160408-LH	0.8	0.5-5.0	0.15-0.60																				●										●	
	VCGX160412-LH	1.2	0.5-5.0	0.15-0.80																				○										●	
	VCGX220530-LH	3	0.5-7.0	0.25-1.00																				○										●○	

● Ex stock ○ On demand

HC¹ Coated carbide
 HT Uncoated cermet
 HC² Coated cermet
 HW Uncoated carbide

Tool holder						
SVVCN	SVJCR/L	SVACR/L-SC	SVJCR/L-SC	S***-SVQCR/L	S***-SVUCR/L	C***-SVQCR/L
Kr: 72°30'	Kr: 93°	Kr: 90°	Kr: 93°	Kr: 107°30'	Kr: 93°	Kr: 107°30'
A277	A278	A312	A313	A343	A344	A363
C***-SVUCR/L						
Kr: 93°						
A364						



A Turning
B Milling
C Drilling
D Technical Information
E Index

A

Turning

- Ideal machining conditions
- ⊗ Normal machining conditions
- ⊙ Unfavourable machining conditions

VCMT	L	I.C	S	d
11 03	11	6.35	3.18	2.8
16 04	16	9.525	4.76	4.4

Turning inserts

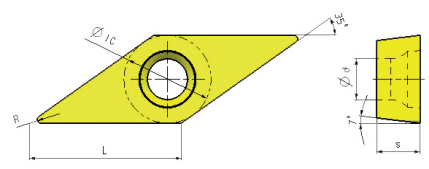

VC** positive insert					HC ¹ (CVD)										HC ¹ (PVD)			HT	HC ²	HW									
					P	●	●	●	⊗	⊗	⊗					●	⊗	●											
					M				●	⊗		●	●	⊗	⊗	●	●	●											
					K							●	●	●	●														
					N							●	●						●	⊗									
					S									●	●	⊗	⊗	●		●	⊗								
					H																								
ISO		r	a _p	f	YBC103	YB6315	YBC152	YBC203	YBC252	YBC352	YBM153	YBM253	YBD102	YB7315	YBD152	YBD152C	YBG101	YBG102	YBG105	YBG205	YB9320	YPD201	YBS103	YNG151	YNT251	YNG151C	YD101	YD201	
XF	VCMT110302-XF	0.2	0.5-2.0	0.08-0.20				○																					
	VCMT110304-XF	0.4	0.5-2.0	0.08-0.20	●																								
	VCMT110308-XF	0.8	0.5-2.0	0.08-0.25	●																								
	VCMT160404-XF	0.4	0.5-2.5	0.08-0.20	●																								
Finishing	VCMT160408-XF	0.8	0.5-2.5	0.08-0.25	●																								
EF	VCMT160404-EF	0.4	0.5-2.5	0.05-0.20															●										
Medium Cut																													
EM	VCMT160404-EM	0.4	0.5-2.5	0.05-0.35								○							●										
	VCMT160408-EM	0.8	0.5-2.5	0.10-0.45								○							●										
Medium Cut																													
XM	VCMT160412-XM	1.2	1-2.5	0.15-0.35	○		○																						
Medium Cut																													

● Ex stock ○ On demand
 YBC152F, YBC252F, YBM153F, YBM253F available

HC¹ Coated carbide
 HT Uncoated cermet
 HC² Coated cermet
 HW Uncoated carbide

B

Milling

C

Drilling

D

Technical Information

E

Index

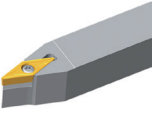
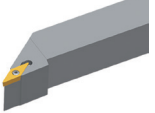
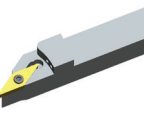
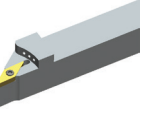
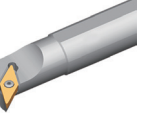
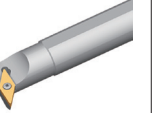
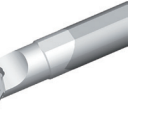

Tool holder						
SVVCN Kr: 72°30'	SVJCR/L Kr: 93°	SVACR/L-SC Kr: 90°	SVJCR/L-SC Kr: 93°	S***-SVQCR/L Kr: 107°30'	S***-SVUCR/L Kr: 93°	C***-SVQCR/L Kr: 107°30'
						
A277	A278	A312	A313	A343	A344	A363

C***-SVUCR/L Kr: 93°

A364

A
Turning
B
Milling
C
Drilling
D
Technical Information
E
Index

System code > A48

Grade selection > A42

Technical info > A501

Cutting data > A366

C N G A 12 04 08 T 020 20 – 2 (W)

1 2 3 4 5 6 7 8 9 10 11 12

A

Turning

B

Milling

C















Drilling









D

Technical Information

E

Index

Insert shape		
A 	B 	C 
D 	E 	H 
K 	L 	M 
P 	S 	T 
V 	W 	Z Special







Clearance angle	
A 	B 
C 	D 
E 	F 
G 	N 
P 	O Special

Tolerance class			
Code	I.C [mm]	m [mm]	S [mm]
A	±0,025	±0,005	±0,025
C	±0,025	±0,013	±0,025
E	±0,025	±0,025	±0,025
F	±0,013	±0,005	±0,025
G	±0,025	±0,025	±0,130
H	±0,013	±0,013	±0,025
J	±0,05–0,15	±0,005	±0,025
K	±0,05–0,15	±0,013	±0,025
L	±0,05–0,15	±0,025	±0,025
M	±0,05–0,15	±0,08–0,20	±0,130
N	±0,05–0,15	±0,08–0,20	±0,025
U	±0,08–0,25	±0,13–0,38	±0,130

1

2

3

Fastening features (metric)	
Insert shape	
A 	B 
C 	N 
Q 	W 
X	Special

Cutting edge length l [mm]						
I.C [mm]	Insert shape					
	C	D	S	T	V	W
3,97				06		
5,0				09		
5,56				09		
6,0				09		
6,35	06	07		11	11	
8,0				09		
9,525	09	11	09	16	16	06
10,0				09		
12,0				09		
12,7	12	15	12	22	22	08
15,875	16		15	27		
16,0		19				
19,05	19		19	33		
20,0				09		
25,0	25	25				
25,4			25			
31,75				09		
32				09		

4



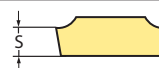

5

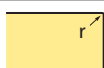
Insert thickness S [mm]			
			
Code	S	Code	S
02	2,38	06	6,35
T2	2,58	T6	6,75
03	3,18	07	7,94
T3	3,97	09	9,52
04	4,76	T9	9,72
T4	4,96	11	11,11
05	5,56	12	12,70
T5	5,95		

6

Nose radius r [mm]	
	
Code	r
00	-
02	0,2
04	0,4
08	0,8
12	1,2
16	1,6
20	2,0
24	2,4
32	3,2
X	Special
MO	Round inserts

7

Cutting edge profile		
Code	Cutting edge	Insert shape
E	Rounding	
F	Sharp edge	
T	Chamfer	
S	Chamfer + Rounding	



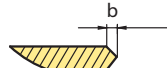

8

Chamfer width b [mm]	
	
Code	b
010	0,10
015	0,15
020	0,20
025	0,25
030	0,30
035	0,35
040	0,40
045	0,45
050	0,50
100	1,00
200	2,00

9

Chamfer angle α	
	
Code	α
05	5°
10	10°
15	15°
20	20°
25	25°
30	30°

10

Cutting edges	
Code	Form
1	
2	
3	
4	

11

Extra	
Code	Description
W	Wiper
HS	Full face single brazed CBN insert
M	Solid CBN with clamping dimple
CB	Chip breaker (CBN)
MED	Chip breaker, fine – medium (PCD)
ROF	Chip breaker, medium – roughing (PCD)
L (L/R)	Full-edge tipped (PCD)

12

A

Turning

B

Milling

C

Drilling

D

Technical Information

E

Index

A

Turning

B

Milling

C



Drilling

D

Technical Information









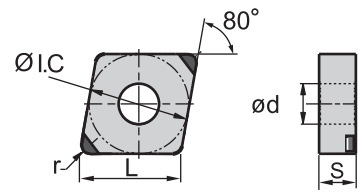

E





































Index

-  Ideal machining conditions
-  Normal machining conditions
-  Unfavourable machining conditions

CNGA	L	I.C	S	d
12 04	12.9	12.7	4.76	5.16



Turning CBN inserts

CN** negative insert		BL (CBN)			BC (CBN)			BH (CBN)		
	P									
	M									
	K									
	N									
	S									
	H									

ISO	r	a _p	f	YCB112	YCB113	YCB121	YCB131	YCB113C	YCB121C	YCB131C	YCB215
CNGA120402S01020-2	0.2	0.08-0.50	0.05-0.15								
CNGA120402S01225-2	0.2	0.08-0.50	0.05-0.15								
CNGA120404E-2	0.4	0.08-0.50	0.05-0.20								
CNGA120404S01020-2	0.4	0.08-0.50	0.05-0.20								
CNGA120404S01225-2	0.4	0.08-0.50	0.05-0.20								
CNGA120408E-2	0.8	0.08-0.50	0.05-0.25								
CNGA120408S01525-2	0.8	0.08-0.50	0.05-0.25								
CNGA120408S02020-2	0.8	0.08-0.50	0.05-0.25								
CNGA120412E-2	1.2	0.08-0.50	0.05-0.30								
CNGA120412S01020-2	1.2	0.08-0.50	0.05-0.30								
CNGA120412S01525-2	1.2	0.08-0.50	0.05-0.30								
CNGA120412S02020-2	1.2	0.08-0.50	0.05-0.30								
CNGA120416S01020-2	1.6	0.08-0.50	0.05-0.35								
CNGA120416S01525-2	1.6	0.08-0.50	0.05-0.35								
CNGA120416S02020-2	1.6	0.08-0.50	0.05-0.35								
CNGA120408S01525-2W	0.8	0.08-0.50	0.05-0.25								
CNGA120408S02020-2W	0.8	0.08-0.50	0.05-0.25								

● Ex stock ○ On demand

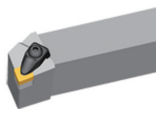
BL CBN with a low CBN content
 BC CBN with coating
 BH CBN with a high CBN content

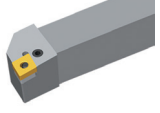
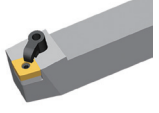
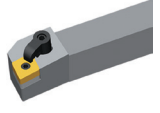
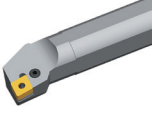
Tool holder					
DCLNR/L	PCBNR/L	PCLNR/L	MCBNR/L	MCLNR/L	S***-PCLNR/L
Kr: 95°	Kr: 75°	Kr: 95°	Kr: 75°	Kr: 95°	Kr: 95°
					
A230	A237	A238	A252	A253	A324



- Ideal machining conditions
- ⊗ Normal machining conditions
- ⊗ Unfavourable machining conditions

DNGA	L	I.C	S	d
15 06	15.5	12.7	6.35	5.16

Turning CBN inserts

DN** negative insert				BL (CBN)				BC (CBN)			BH (CBN)		
	P												
	M												
	K												
	N												
	S	●			⊗								
	H	○	⊗	⊗					○	⊗	⊗		
ISO	r	a _p	f	YCB112	YCB113	YCB121	YCB131	YCB113C	YCB121C	YCB131C		YCB215	
DNGA150604E-2	0.4	0.08-0.50	0.05-0.20	○		○							
DNGA150604S01020-2	0.4	0.08-0.50	0.05-0.20			○			○			○	
DNGA150604S01225-2	0.4	0.08-0.50	0.05-0.20	○		○			○				
DNGA150608E-2	0.8	0.08-0.50	0.05-0.25	○		○							
DNGA150608S01020-2	0.8	0.08-0.50	0.05-0.25									○	
DNGA150608S01525-2	0.8	0.08-0.50	0.05-0.25	●		●		●					
DNGA150608S02020-2	0.8	0.08-0.50	0.05-0.25			●			●				
DNGA150612S01020-2	1.2	0.08-0.50	0.05-0.30									○	
DNGA150612S01525-2	1.2	0.08-0.50	0.05-0.30	●		○			○				
DNGA150612S02020-2	1.2	0.08-0.50	0.05-0.30			●							



● Ex stock ○ On demand

BL CBN with a low CBN content
 BC CBN with coating
 BH CBN with a high CBN content

Tool holder						
DDJNR/L	PDJNR/L	PDNNR/L	MDJNR/L	MDPNN	S***-PDSNR/L	S***-PDUNR/L
Kr: 93°	Kr: 93°	Kr: 63°	Kr: 93°	Kr: 62°30'	Kr: 62°30'	Kr: 93°
A231	A240	A241	A254	A255	A326	A327







A

Turning

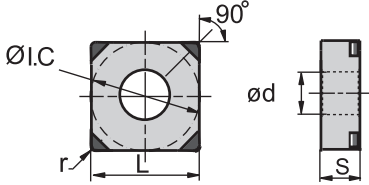
-  Ideal machining conditions
-  Normal machining conditions
-  Unfavourable machining conditions













SNGA	L	I.C	S	d
12 04	12.7	12.7	4.76	5.16

Turning CBN inserts

SN** negative insert				BL (CBN)			BC (CBN)			BH (CBN)		
	P											
	M											
	K											
	N											
	S											
	H											

B

Milling



ISO	r	a _p	f	BL (CBN)			BC (CBN)			BH (CBN)			
				YCB112	YCB113	YCB121	YCB131	YCB113C	YCB121C	YCB131C	YCB215		
	SNGA120408S01020-4	0.8	0.08-0.50	0.05-0.25									
	SNGA120408S01525-4	0.8	0.08-0.50	0.05-0.25									
	SNGA120408S02020-4	0.8	0.08-0.50	0.05-0.25									
	SNGA120412S01020-4	1.2	0.08-0.50	0.05-0.30									
	SNGA120412S01525-4	1.2	0.08-0.50	0.05-0.30									
	SNGA120412S02020-4	1.2	0.08-0.50	0.05-0.30									

● Ex stock ○ On demand

BL CBN with a low CBN content
 BC CBN with coating
 BH CBN with a high CBN content

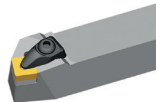
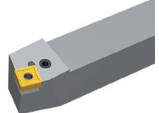
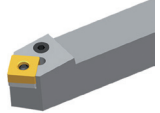
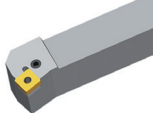

C

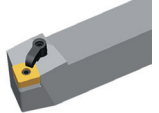
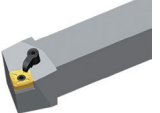
Drilling

Tool holder						
DSBNR/L	PSBNR/L	PSDNN	PSKNR/L	PSSNR/L	MSBNR/L	MSRNR/L
Kr: 75°	Kr: 75°	Kr: 45°	Kr: 75°	Kr: 45°	Kr: 75°	Kr: 75°
						
A232	A242	A244	A245	A246	A256	A257

D

Technical Information

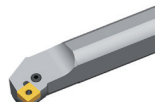
MSKNR/L	MSDNN	S***-PSKNR/L
Kr: 75°	Kr: 45°	Kr: 75°
		
A258	A259	A329

E



Index

System code > A158

Grade selection > A42







Technical info > A501

Cutting data > A366

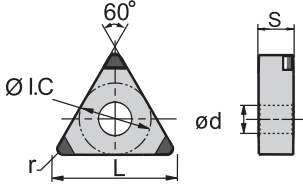
-  Ideal machining conditions
-  Normal machining conditions
-  Unfavourable machining conditions

TNGA	L	I.C	S	d
16 04	16.5	9.525	4.76	3.81

Turning CBN inserts

TN** negative insert					BL (CBN)				BC (CBN)			BH (CBN)			
	P														
	M														
	K														
	N														
	S														
	H														
ISO	r	a _p	f	YCB112	YCB113	YCB121	YCB131	YCB113C	YCB121C	YCB131C		YCB215			
TNGA160404S01020-3	0.4	0.08-0.50	0.05-0.20												
TNGA160404S01225-3	0.4	0.08-0.50	0.05-0.20												
TNGA160408S01020-3	0.8	0.08-0.50	0.05-0.25												
TNGA160408S01525-3	0.8	0.08-0.50	0.05-0.25												
TNGA160408S02020-3	0.8	0.08-0.50	0.05-0.25												
TNGA160412S01020-3	1.2	0.08-0.50	0.05-0.30												
TNGA160412S01525-3	1.2	0.08-0.50	0.05-0.30												
TNGA160412S02020-3	1.2	0.08-0.50	0.05-0.30												

● Ex stock ○ On demand

BL CBN with a low CBN content
 BC CBN with coating
 BH CBN with a high CBN content

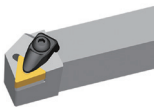
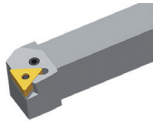
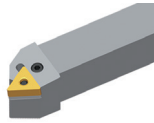
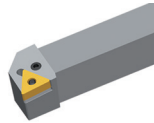
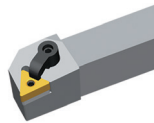
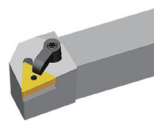
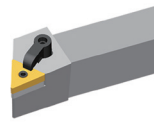
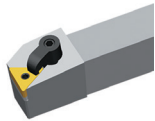
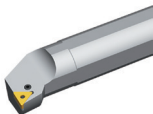
Tool holder						
DTGNR/L Kr: 91°	PTFNR/L Kr: 91°	PTTNR/L Kr: 60°	PTGNR/L Kr: 90°	MTGNR/L Kr: 90°	MTJNR/L Kr: 93°	MTJNR/L-Z Kr: 93°
						
A233	A247	A248	A249	A260	A261	A262
MTFNR/L Kr: 91°	S***-PTFNR/L Kr: 90°					
						
A263	A330					

System code > A158

Grade selection > A42

Technical info > A501

Cutting data > A366



A

Turning

B

Milling

C

Drilling

D

Technical Information

E

Index

A

Turning

- Ideal machining conditions
- ⊗ Normal machining conditions
- ⊗ Unfavourable machining conditions

VNGA	L	I.C	S	d
16 04	16.6	9.525	4.76	3.81

Turning CBN inserts

VN** negative insert				BL (CBN)			BC (CBN)			BH (CBN)				
				P										
				M										
				K										
				N										
				S	●	⊗								
				H	○	⊗	⊗							

B

Milling

ISO	r	a _p	f	BL (CBN)			BC (CBN)			BH (CBN)		
				YCB112	YCB113	YCB121	YCB131	YCB113C	YCB121C	YCB131C	YCB215	
	VNGA160404S01020-2	0.4	0.08-0.50	0.05-0.20		●						○
	VNGA160404S01225-2	0.4	0.08-0.50	0.05-0.20		●						○
	VNGA160408S01020-2	0.8	0.08-0.50	0.05-0.25								○
	VNGA160408S01525-2	0.8	0.08-0.50	0.05-0.25		●						○
	VNGA160408S02020-2	0.8	0.08-0.50	0.05-0.25			●					○

● Ex stock ○ On demand

BL CBN with a low CBN content
 BC CBN with coating
 BH CBN with a high CBN content

C

Drilling

Tool holder			
DVVNN	DVJNR/L	MVVNN	MVJNR/L
Kr: 72°30'	Kr: 93°	Kr: 72°30'	Kr: 93°
A234	A235	A264	A265



D

Technical Information

E







Index

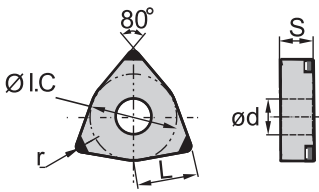

-  Ideal machining conditions
-  Normal machining conditions
-  Unfavourable machining conditions



WNGA	L	I.C	S	d
08 04	8.69	12.7	4.76	5.16

Turning CBN inserts

WN** negative insert					BL (CBN)				BC (CBN)			BH (CBN)		
	P													
	M													
	K													
	N													
	S													
	H													
ISO	r	a _p	f	YCB112	YCB113	YCB121	YCB131	YCB113C	YCB121C	YCB131C		YCB215		
	WNGA080404S01020-3	0.4	0.08-0.50	0.05-0.20										
	WNGA080404S01225-3	0.4	0.08-0.50	0.05-0.20										
	WNGA080408S01020-3	0.8	0.08-0.50	0.05-0.25										
	WNGA080408S01525-3	0.8	0.08-0.50	0.05-0.25										
	WNGA080408S02020-3	0.8	0.08-0.50	0.05-0.25										
	WNGA080412S01020-3	1.2	0.08-0.50	0.05-0.30										
	WNGA080412S01525-3	1.2	0.08-0.50	0.05-0.30										
	WNGA080412S02020-3	1.2	0.08-0.50	0.05-0.30										

● Ex stock ○ On demand

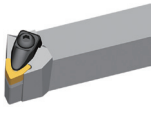
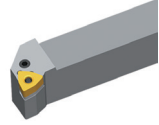
BL CBN with a low CBN content
 BC CBN with coating
 BH CBN with a high CBN content

Tool holder			
DWLNLR/L	PWLNLR/L	MWLNLR/L	S***-PWLNLR/L
Kr: 95°	Kr: 95°	Kr: 95°	Kr: 95°
			
A236	A251	A266	A332

System code > A158

Grade selection > A42

Technical info > A501

Cutting data > A366



A

Turning

B

Milling

C

Drilling

D

Technical Information

E

Index

A

Turning

- Ideal machining conditions
- ⊗ Normal machining conditions
- ⊗ Unfavourable machining conditions

ZNEX	I.C	S	d
04 01	4.76	1.59	2.3

Turning CBN inserts

ZN** negative insert				BL (CBN)			BC (CBN)			BH (CBN)		
	P											
	M											
	K										●	
	N											
	S	●	⊗									
	H	○	⊗	⊗			○	⊗	⊗			

B

Milling

ISO	r	a _p	f	BL (CBN)			BC (CBN)			BH (CBN)		
				YCB112	YCB113	YCB121	YCB131	YCB113C	YCB121C	YCB131C	YCB215	
	ZNEX040102S01515	0.2	0.08-0.50	0.05-0.15	○	○						
	ZNEX040104S01515	0.4	0.08-0.50	0.05-0.20	○	○						

● Ex stock ○ On demand

BL CBN with a low CBN content
 BC CBN with coating
 BH CBN with a high CBN content

C

Drilling

Tool holder
C*-SZLNR/L**
 Kr: 95°

A365

D

Technical Information

E

Index



Turning CBN inserts

- Ideal machining conditions
- ⊗ Normal machining conditions
- ⊗ Unfavourable machining conditions

CCGW	L	I.C	S	d
06 02	6.4	6.35	2.38	2.8
09 T3	9.7	9.525	3.97	4.4
12 04	12.9	12.7	4.76	5.5





CC** positive insert				BL (CBN)				BC (CBN)			BH (CBN)				
				P											
				M											
				K							●				
				N											
				S	●	⊗									
				H	○	⊗	⊗				○	⊗	⊗		
ISO	r	a _p	f	YCB112	YCB113	YCB121	YCB131	YCB113C	YCB121C	YCB131C	YCB215				
CCGW060202S01020-2	0.2	0.08-0.50	0.05-0.20		○				○		○				
CCGW060202S01225-2	0.2	0.08-0.50	0.05-0.150.05-0.20		○				○		○				
CCGW060204S01020-2	0.4	0.08-0.50	0.05-0.20		○				○		○				
CCGW060204S01225-2	0.4	0.08-0.50	0.05-0.20		○				○		○				
CCGW060208S01020-2	0.8	0.08-0.50	0.05-0.25								○				
CCGW060208S01525-2	0.8	0.08-0.50	0.05-0.25		○				○						
CCGW060208S02020-2	0.8	0.08-0.50	0.05-0.25			○			○						
CCGW09T302S01020-2	0.2	0.08-0.50	0.05-0.15			○			○		○				
CCGW09T302S01225-2	0.2	0.08-0.50	0.05-0.15			○			○		○				
CCGW09T304E-2	0.4	0.08-0.50	0.05-0.20		○		○								
CCGW09T304S01020-2	0.4	0.08-0.50	0.05-0.20			●			○		○				
CCGW09T304S01225-2	0.4	0.08-0.50	0.05-0.20		●				○						
CCGW09T308E-2	0.8	0.08-0.50	0.05-0.25		○		○								
CCGW09T308S01020-2	0.8	0.08-0.50	0.05-0.25								●				
CCGW09T308S01525-2	0.8	0.08-0.50	0.05-0.25		●	○			○						
CCGW09T308S02020-2	0.8	0.08-0.50	0.05-0.25			●			●						
CCGW09T312E-2	1.2	0.08-0.50	0.05-0.30		○		○								
CCGW120404S01020-2	0.4	0.08-0.50	0.05-0.20			○			○		○				
CCGW120404S01225-2	0.4	0.08-0.50	0.05-0.20			○			○						
CCGW120408S01020-2	0.8	0.08-0.50	0.05-0.25								○				
CCGW120408S01525-2	0.8	0.08-0.50	0.05-0.25			○	○		○						
CCGW120408S02020-2	0.8	0.08-0.50	0.05-0.25				○		○						
CCGW120412S01020-2	1.2	0.08-0.50	0.05-0.30								○				
CCGW120412S01525-2	1.2	0.08-0.50	0.05-0.30			○	○		○						
CCGW120412S02020-2	1.2	0.08-0.50	0.05-0.30				○		○						

● Ex stock ○ On demand

BL CBN with a low CBN content
 BC CBN with coating
 BH CBN with a high CBN content

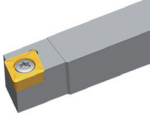
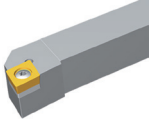
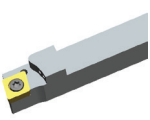
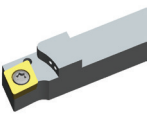
A

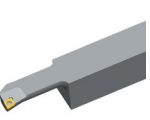
Turning

Tool holder						
SCACR/L	SCLCR/L	SCACR/L-SC	SCLCR/L-SC	A***-SCLCR/L	S***-SCFCR/L	S***-SCLCR
Kr: 90°	Kr: 95°	Kr: 90°	Kr: 95°	Kr: 95°	Kr: 90°	Kr: 95°
						
A269	A270	A306	A307	A334	A352	A353

B

Milling

E***-SCLCR/L
Kr: 95°

A355

C

Drilling

D

Technical Information

E

Index

System code > A158

Grade selection > A42

Technical info > A501

Cutting data > A366

- Ideal machining conditions
- ⊗ Normal machining conditions
- ⊗ Unfavourable machining conditions

DCGW	L	I.C	S	d
07 02	7.8	6.35	2.38	2.8
11 T3	11.6	9.525	3.97	4.4

Turning CBN inserts

DC** positive insert					BL (CBN)				BC (CBN)			BH (CBN)						
					P													
					M													
					K													
					N													
					S	●		⊗										
					H	○	⊗	⊗		○	⊗	⊗						
ISO	r	a _p	f	YCB112	YCB113	YCB121	YCB131	YCB113C	YCB121C	YCB131C	YCB215							
DCGW070202S01020-2	0.2	0.08-0.50	0.05-0.15	●				○										
DCGW070202S01225-2	0.2	0.08-0.50	0.05-0.15	○				○										
DCGW070204S01020-2	0.4	0.08-0.50	0.05-0.20	●				○			○							
DCGW070204S01225-2	0.4	0.08-0.50	0.05-0.20	●				○										
DCGW070208S01020-2	0.8	0.08-0.50	0.05-0.25								○							
DCGW070208S01525-2	0.8	0.08-0.50	0.05-0.25	●				○										
DCGW070208S02020-2	0.8	0.08-0.50	0.05-0.25	●				○										
DCGW11T302S01020-2	0.2	0.08-0.50	0.05-0.15	○				○			○							
DCGW11T302S01225-2	0.2	0.08-0.50	0.05-0.15	○				○										
DCGW11T304E-2	0.4	0.08-0.50	0.05-0.20	○		○												
DCGW11T304S01020-2	0.4	0.08-0.50	0.05-0.20	●				○			●							
DCGW11T304S01225-2	0.4	0.08-0.50	0.05-0.20	●				○										
DCGW11T308E-2	0.8	0.08-0.50	0.05-0.25	○		○												
DCGW11T308S01020-2	0.8	0.08-0.50	0.05-0.25								●							
DCGW11T308S01525-2	0.8	0.08-0.50	0.05-0.25	●		○		●										
DCGW11T308S02020-2	0.8	0.08-0.50	0.05-0.25	●				●										
DCGW11T312E-2	1.2	0.08-0.50	0.05-0.30	○		○												

● Ex stock ○ On demand

BL CBN with a low CBN content
 BC CBN with coating
 BH CBN with a high CBN content

Tool holder						
SDACR/L	SDJCR/L	SDNCN	SDACR/L-SC	SDHCR/L-SC	SDJCR/L-SC	SDNCN-SC
Kr: 90°	Kr: 93°	Kr: 62°30'	Kr: 90°	Kr: 107°30'	Kr: 93°	Kr: 62°30'
A271	A272	A273	A308	A309	A310	A311

S***-SDQCR/L	A***-SDUCR/L	S***-SDZCR/L	E***-SDQCR/L
Kr: 107°30'	Kr: 93°	Kr: 85°	Kr: 107°30'
A336	A337	A338	A357

System code > A158

Grade selection > A42

Technical info > A501

Cutting data > A366



A

Turning

- Ideal machining conditions
- ⊗ Normal machining conditions
- ⊗ Unfavourable machining conditions

TCGW	L	I.C	S	d
11 02	11	6.35	2.38	2.5
16 T3	16.5	9.525	3.97	4.4

Turning CBN inserts

TC** positive insert				BL (CBN)			BC (CBN)			BH (CBN)		
	P											
	M											
	K										●	
	N											
	S	●	⊗									
	H	○	⊗	⊗			○	⊗	⊗			

B

Milling

ISO	r	a _p	f	YCB112	YCB113	YCB121	YCB131	YCB113C	YCB121C	YCB131C	YCB215
					TCGW110204S01020-3	0.4	0.08-0.50	0.05-0.20		○	
	TCGW110204S01225-3	0.4	0.08-0.50	0.05-0.20	○			○			○
	TCGW110208S01020-3	0.8	0.08-0.50	0.05-0.25							○
	TCGW110208S01525-3	0.8	0.08-0.50	0.05-0.25	○			○			○
	TCGW110208S02020-3	0.8	0.08-0.50	0.05-0.25	○			○			○
	TCGW16T304S01020-3	0.4	0.08-0.50	0.05-0.20		●		○			○
	TCGW16T304S01225-3	0.4	0.08-0.50	0.05-0.20	●			○			○
	TCGW16T308S01020-3	0.8	0.08-0.50	0.05-0.25							○
	TCGW16T308S01525-3	0.8	0.08-0.50	0.05-0.25	●			○			○
	TCGW16T308S02020-3	0.8	0.08-0.50	0.05-0.25		●		○			○

● Ex stock ○ On demand

BL CBN with a low CBN content
 BC CBN with coating
 BH CBN with a high CBN content

C

Drilling

Tool holder					
STACR/L	STFCR/L	STGCR/L	STTCR/L	S***-STFCR/L	E***-STFCR/L
Kr: 90°	Kr: 91°	Kr: 91°	Kr: 60°	Kr: 91°	Kr: 90°
A283	A284	A285	A286	A341	A361



D

Technical Information

E











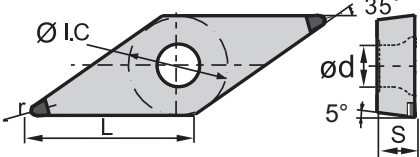







Index



-  Ideal machining conditions
-  Normal machining conditions
-  Unfavourable machining conditions



VBGW	L	I.C	S	d
16 04	16.6	9.525	4.76	4.4

Turning CBN inserts

VB** positive insert				BL (CBN)				BC (CBN)			BH (CBN)						
				P													
				M													
				K													
				N													
				S													
				H													
ISO	r	a _p	f	YCB112	YCB113	YCB121	YCB131	YCB113C	YCB121C	YCB131C	YCB215						
	VBGW160404S01020-2	0.4	0.08-0.50	0.05-0.20													
	VBGW160404S01225-2	0.4	0.08-0.50	0.05-0.20													
	VBGW160408S01020-2	0.8	0.08-0.50	0.05-0.25													
	VBGW160408S01525-2	0.8	0.08-0.50	0.05-0.25													
	VBGW160408S02020-2	0.8	0.08-0.50	0.05-0.25													

● Ex stock ○ On demand

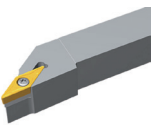
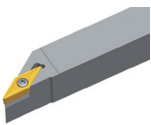
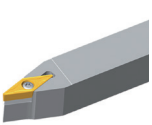
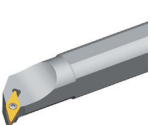
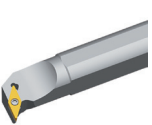
BL CBN with a low CBN content
 BC CBN with coating
 BH CBN with a high CBN content

Tool holder					
SVJBR/L	SVABR/L	SVVBN	S***-SVQBR/L	S***-SVUBR/L	S***-SVXBR/L
Kr: 93°	Kr: 90°	Kr: 72°30'	Kr: 107°30'	Kr: 93°	Kr: 93°
					
A274	A275	A276	A345	A346	A347

System code > A158

Grade selection > A42



Technical info > A501

Cutting data > A366











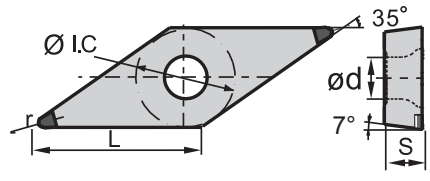

A

Turning

-  Ideal machining conditions
-  Normal machining conditions
-  Unfavourable machining conditions





















VCGW	L	I.C	S	d
11 03	11.1	6.35	3.18	2.8
16 04	16.6	9.525	4.76	4.4

Turning CBN inserts

VC** positive insert		BL (CBN)			BC (CBN)			BH (CBN)		
	P									
	M									
	K									
	N									
	S									
	H									

B

Milling





ISO	r	a _p	f	BL (CBN)			BC (CBN)			BH (CBN)
				YCB112	YCB113	YCB121	YCB131	YCB113C	YCB121C	YCB131C
VCGW110302E-2	0.2	0.08-0.50	0.05-0.15							
VCGW110304E-2	0.4	0.08-0.50	0.05-0.20							
VCGW160404E-2	0.4	0.08-0.50	0.05-0.20							
VCGW160404S01020-2	0.4	0.08-0.50	0.05-0.20							
VCGW160404S01225-2	0.4	0.08-0.50	0.05-0.20							
VCGW160408E-2	0.8	0.08-0.50	0.05-0.25							
VCGW160408S01020-2	0.8	0.08-0.50	0.05-0.25							
VCGW160408S01525-2	0.8	0.08-0.50	0.05-0.25							
VCGW160408S02020-2	0.8	0.08-0.50	0.05-0.25							
VCGW160412E-2	1.2	0.08-0.50	0.05-0.30							

● Ex stock ○ On demand

BL CBN with a low CBN content
 BC CBN with coating
 BH CBN with a high CBN content

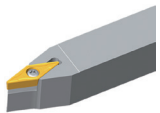
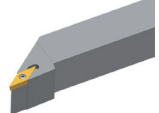
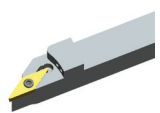
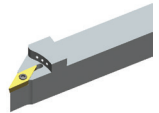
C

Drilling

Tool holder						
SVVCN Kr: 72°30'	SVJCR/L Kr: 93°	SVACR/L-SC Kr: 90°	SVJCR/L-SC Kr: 93°	S***-SVQCR/L Kr: 107°30'	S***-SVUCR/L Kr: 93°	C***-SVQCR/L Kr: 107°30'
						
A277	A278	A312	A313	A343	A344	A363

D



Technical Information

C***-SVUCR/L Kr: 93°

A364

E







Index

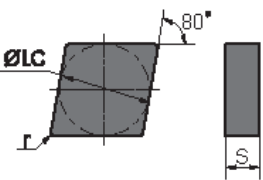

-  Ideal machining conditions
-  Normal machining conditions
-  Unfavourable machining conditions

CNGN	L	I.C	S
09 03	9.7	9.525	3.18
12 04	12.9	12.7	4.76

Turning CBN inserts

CN** negative insert				BL (CBN)	BC (CBN)	BH (CBN)	
				P			
				M			
				K			
				N			
				S			
				H			
ISO	r	a _p	f	YZB630	YZB630C	YZB223	
	CNGN090308S01525	0.8	0.5-2.0	0.3-0.5	○	○	○
	CNGN090308T01525	0.8	0.5-2.0	0.3-0.5			○
	CNGN090312S01525	1.2	0.5-2.0	0.3-0.5	○	○	○
	CNGN090312T01525	1.2	0.5-2.0	0.3-0.5			○
	CNGN120408S01525	0.8	0.5-2.0	0.3-0.5	○	○	
	CNGN120408T01525	0.8	0.5-2.0	0.3-0.5			●
	CNGN120412S01525	1.2	0.5-2.0	0.3-0.5	●	○	
	CNGN120412T01525	1.2	0.5-2.0	0.3-0.5			●
	CNGN120416S01525	1.6	0.5-2.0	0.3-0.5	○	○	
	CNGN120408T01525-M	0.8	0.5-2.0	0.3-0.5			○
	CNGN120412T01525-M	1.2	0.5-2.0	0.3-0.5			○
	CNGN120416T01525-M	1.6	0.5-2.0	0.3-0.5			○

● Ex stock ○ On demand

BL CBN with a low CBN content
 BC CBN with coating
 BH CBN with a high CBN content

Tool holder

CCLNR/L

Kr: 95°

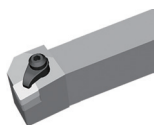

A292

System code > A158

Grade selection > A42

Technical info > A501

Cutting data > A366

A

Turning

- Ideal machining conditions
- ⊗ Normal machining conditions
- ⊗ Unfavourable machining conditions

RNGN	I.C	S
09 03	9.525	3.18
12 04	12.7	4.76

Turning CBN inserts

RN** negative insert		BL (CBN)	BC (CBN)	BH (CBN)
	P			
	M			
	K			⊗
	N			
	S			
	H	⊗	⊗	

B

Milling

ISO	a _p	f	YZB630	YZB630C	YZB223
	RNGN090300S01525	0.5-2.0	0.3-0.5	○	○
	RNGN090300T01525	0.5-2.0	0.3-0.5	○	○
	RNGN120400S01525	0.5-2.0	0.3-0.5	○	○
	RNGN120400T01525	0.5-2.0	0.3-0.5	○	●

● Ex stock ○ On demand

BL CBN with a low CBN content
 BC CBN with coating
 BH CBN with a high CBN content

C

Drilling

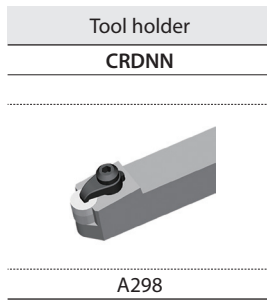

D

Technical Information

E



Index

System code > A158

Grade selection > A42











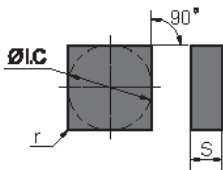



Technical info > A501

Cutting data > A366

-  Ideal machining conditions
-  Normal machining conditions
-  Unfavourable machining conditions

SNGN	L	I.C	S
12 04	12.7	12.7	4.76

Turning CBN inserts

SN** negative insert				BL (CBN)	BC (CBN)	BH (CBN)	
				P			
				M			
				K			
				N			
				S			
				H			
ISO	r	a _p	f	YZB630	YZB630C	YZB223	
	SNGN120408S01525	0.8	0.5-2.0	0.3-0.5			
	SNGN120408T01525	0.8	0.5-2.0	0.3-0.5			
	SNGN120412S01525	1.2	0.5-2.0	0.3-0.5			
	SNGN120412T01525	1.2	0.5-2.0	0.3-0.5			
	SNGN120416T01525	1.6	0.5-2.0	0.3-0.5			
	SNGN120412T01525-M	1.2	0.5-2.0	0.3-0.5			
	SNGN120416T01525-M	1.6	0.5-2.0	0.3-0.5			

● Ex stock ○ On demand

BL CBN with a low CBN content
 BC CBN with coating
 BH CBN with a high CBN content

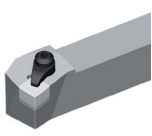
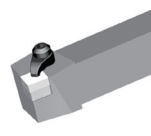
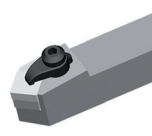
Tool holder		
CSKNR/L Kr: 75°	CSRNR/L Kr: 75°	CSDNN Kr: 45°
		
A296	A297	A299

A

Turning

- Ideal machining conditions
- ⊗ Normal machining conditions
- ⊗ Unfavourable machining conditions

WNGN	L	I.C	S
08 04	8.69	12.7	4.76

Turning CBN inserts

WN** negative insert				BL (CBN)	BC (CBN)	BH (CBN)
	P					
	M					
	K				⊗	
	N					
	S					
	H	⊗			⊗	

B

Milling

ISO		r	a _p	f	YZB630	YZB630C	YZB223
	WNGN080408T01525	0.8	0.5-2.0	0.3-0.5			○
	WNGN080412T01525	1.2	0.5-2.0	0.3-0.5			○
	WNGN080416T01525	1.6	0.5-2.0	0.3-0.5			○
	WNGN080408T01525-M	0.8	0.5-2.0	0.3-0.5			○
	WNGN080412T01525-M	1.2	0.5-2.0	0.3-0.5			○
	WNGN080416T01525-M	1.6	0.5-2.0	0.3-0.5			○

C

Drilling

● Ex stock ○ On demand

BL CBN with a low CBN content
 BC CBN with coating
 BH CBN with a high CBN content



D

Technical Information

E







Index

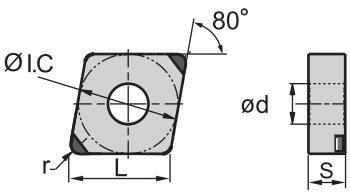

-  Ideal machining conditions
-  Normal machining conditions
-  Unfavourable machining conditions

CNGA	L	I.C	S	d
12 04	12.9	12.7	4.76	5.16

Turning PCD inserts

CN** negative insert				DP																								
				P																								
				M																								
				K																								
				N																								
				S																								
H																												
ISO	r	a _p	f	YCD421																								
	CNGA120402F-1	0.2	0.08-0.50	0.05-0.15																								
	CNGA120404F-1	0.4	0.08-0.50	0.05-0.20																								
	CNGA120408F-1	0.8	0.08-0.50	0.05-0.25																								
	CNGA120412F-1	1.2	0.08-0.50	0.05-0.30																								

● Ex stock ○ On demand

DP Polycrystalline diamond

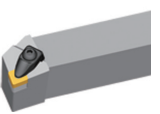
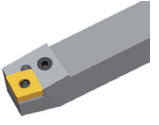
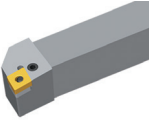
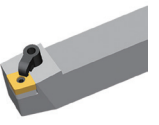
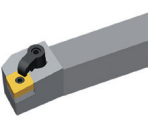
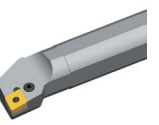
Tool holder					
DCLNR/L	PCBNR/L	PCLNR/L	MCBNR/L	MCLNR/L	S***-PCLNR/L
Kr: 95°	Kr: 75°	Kr: 95°	Kr: 75°	Kr: 95°	Kr: 95°
					
A230	A237	A238	A252	A253	A324

System code > A158

Grade selection > A42

Technical info > A501

Cutting data > A366

General turning PCBN & PCD inserts

A

Turning

- Ideal machining conditions
- ⊗ Normal machining conditions
- ⊙ Unfavourable machining conditions

DNGA	L	I.C	S	d
15 06	15.5	12.7	6.35	5.16

Turning PCD inserts

DN** negative insert		DP																
	P																	
	M																	
	K																	
	N																	
	S																	
	H																	

B

Milling

ISO	r	a _p	f	YCD421	DP														
DNGA150602F-1	0.2	0.08-0.50	0.05-0.15	○															
DNGA150604F-1	0.4	0.08-0.50	0.05-0.20	○															
DNGA150608F-1	0.8	0.08-0.50	0.05-0.25	○															

● Ex stock ○ On demand DP Polycrystalline diamond

C

Drilling

Tool holder						
DDJNR/L	PDJNR/L	PDNNR/L	MDJNR/L	MDPNN	S***-PDSNR/L	S***-PDUNR/L
Kr: 93°	Kr: 93°	Kr: 63°	Kr: 93°	Kr: 62°30'	Kr: 62°30'	Kr: 93°
A231	A240	A241	A254	A255	A326	A327

D

Technical Information

E



Index



- Ideal machining conditions
- Normal machining conditions
- Unfavourable machining conditions

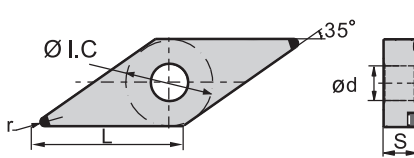

VNGA	L	I.C	S	d
16 04	16.6	9.525	4.76	3.81

Turning PCD inserts

VN** negative insert				DP																						
				P																						
				M																						
				K																						
				N	○																					
				S																						
				H																						
ISO	r	a _p	f	YCD421																						
	VNGA160402F-1	0.2	0.08-0.50	0.05-0.15	○																					
	VNGA160404F-1	0.4	0.08-0.50	0.05-0.20	○																					

● Ex stock ○ On demand

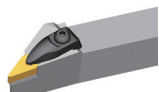
DP Polycrystalline diamond

Tool holder			
DVVNN Kr: 72°30'	DVJNR/L Kr: 93°	MVVNN Kr: 72°30'	MVJNR/L Kr: 93°
			
A234	A235	A264	A265

System code > A158

Grade selection > A42

Technical info > A501

Cutting data > A366



A

Turning

B

Milling

C

Drilling

D

Technical Information

E

Index

CCGT	L	I.C	S	d
06 02	6.4	6.35	2.38	2.8
09 T3	9.7	9.525	3.97	4.4
12 04	12.9	12.7	4.76	5.56

- Ideal machining conditions
- Normal machining conditions
- ⊗ Unfavourable machining conditions

Turning PCD inserts

CC** positive insert		DP									
	P										
	M										
	K										
	N	○									
	S										
	H										

ISO	r	a _p	f	YCD421	
	CCGT060202F-1	0.2	0.05-0.50	0.05-0.15	○
	CCGT060204F-1	0.4	0.08-0.50	0.05-0.20	●
	CCGT060208F-1	0.8	0.08-0.50	0.05-0.25	○
	CCGT09T302F-1	0.2	0.08-0.50	0.05-0.15	○
	CCGT09T304F-1	0.4	0.08-0.50	0.05-0.20	○
	CCGT09T308F-1	0.8	0.08-0.50	0.05-0.25	○
	CCGT120402F-1	0.2	0.08-0.50	0.05-0.15	○
	CCGT120404F-1	0.4	0.08-0.50	0.05-0.20	○
	CCGT120408F-1	0.8	0.08-0.50	0.05-0.25	○
	CCGT060204F-1MED	0.4	0.08-0.50	0.05-0.20	○
	CCGT060208F-1MED	0.8	0.08-0.50	0.05-0.25	○
	CCGT09T302F-1MED	0.2	0.08-0.50	0.05-0.15	○
	CCGT09T304F-1MED	0.4	0.08-0.50	0.05-0.20	○
	CCGT09T308F-1MED	0.8	0.08-0.50	0.05-0.25	○

● Ex stock ○ On demand

DP Polycrystalline diamond

Tool holder						
SCACR/L	SCLCR/L	SCACR/L-SC	SCLCR/L-SC	A***-SCLCR/L	S***-SCFCR/L	S***-SCLCR
Kr: 90°	Kr: 95°	Kr: 90°	Kr: 95°	Kr: 95°	Kr: 90°	Kr: 95°
A269	A270	A306	A307	A334	A352	A353

E*-SCLCR/L**
Kr: 95°

A355

System code > A158

Grade selection > A42

Technical info > A501

Cutting data > A366

- Ideal machining conditions
- ⊗ Normal machining conditions
- ⊗ Unfavourable machining conditions

CCGT	L	I.C	S	d
09 T3	9.7	9.525	3.97	4.4
12 04	12.9	12.7	4.76	5.56

Turning PCD inserts

CC** positive insert		DP				
	P					
	M					
	K					
	N	○				
	S					
	H					

ISO	r	a _p	f	YCD421
CCGT09T308-LL	0.8	0.08-0.50	0.05-0.25	○
CCGT09T308-LR	0.8	0.08-0.50	0.05-0.25	○
CCGT120404-LL	0.4	0.08-0.50	0.05-0.20	○
CCGT120404-LR	0.4	0.08-0.50	0.05-0.20	○
CCGT120408-LL	0.8	0.08-0.50	0.05-0.25	○
CCGT120408-LR	0.8	0.08-0.50	0.05-0.25	○

● Ex stock ○ On demand

DP Polycrystalline diamond

Tool holder						
SCACR/L	SCLCR/L	SCACR/L-SC	SCLCR/L-SC	A***-SCLCR/L	S***-SCFCR/L	S***-SCLCR
Kr: 90°	Kr: 95°	Kr: 90°	Kr: 95°	Kr: 95°	Kr: 90°	Kr: 95°
A269	A270	A306	A307	A334	A352	A353

E***-SCLCR/L
Kr: 95°
A355

A

Turning

B

Milling

C

Drilling

D

Technical Information

E

Index



A

Turning

B

Milling

C

Drilling

D

Technical Information

E

Index

- Ideal machining conditions
- ⊗ Normal machining conditions
- ⊗ Unfavourable machining conditions

CCGW	L	I.C	S	d
06 02	6.4	6.35	2.38	2.8
09 T3	9.7	9.525	3.97	4.4
12 04	12.9	12.7	4.76	5.56

Turning PCD inserts

CC** positive insert				DP		
				P		
				M		
				K		
				N	○	
				S		
				H		
ISO	r	a _p	f	YCD421		
	CCGW060202F-1	0.2	0.08-0.50	0.05-0.15	○	
	CCGW060204F-1	0.4	0.08-0.50	0.05-0.20	○	
	CCGW09T304F-1	0.4	0.08-0.50	0.05-0.20	●	
	CCGW09T308F-1	0.8	0.08-0.50	0.05-0.25	●	
	CCGW120404F-1	0.4	0.08-0.50	0.05-0.20	●	
	CCGW120408F-1	0.8	0.08-0.50	0.05-0.25	●	

● Ex stock ○ On demand DP Polycrystalline diamond

C

Drilling

Tool holder						
SCACR/L	SCLCR/L	SCACR/L-SC	SCLCR/L-SC	A***-SCLCR/L	S***-SCFCR/L	S***-SCLCR
Kr: 90°	Kr: 95°	Kr: 90°	Kr: 95°	Kr: 95°	Kr: 90°	Kr: 95°
A269	A270	A306	A307	A334	A352	A353

D

Technical Information

E***-SCLCR/L
Kr: 95°
A355



Turning PCD inserts

- Ideal machining conditions
- Normal machining conditions
- Unfavourable machining conditions

CCGW	L	I.C	S	d
06 02	6.4	6.35	2.38	2.8
09 T3	9.7	9.525	3.97	4.4
12 04	12.9	12.7	4.76	5.56

CC** positive insert				DP																							
				P																							
				M																							
				K																							
				N																							
				S																							
				H																							
ISO	r	a _p	f	YCD421																							
CCGW060204-LL	0.2	0.08-0.50	0.05-0.20	○																							
CCGW060204-LR	0.4	0.08-0.50	0.05-0.20	○																							
CCGW09T304-LL	0.4	0.08-0.50	0.05-0.20	○																							
CCGW09T304-LR	0.4	0.08-0.50	0.05-0.20	○																							
CCGW09T308-LL	0.8	0.08-0.50	0.05-0.25	○																							
CCGW09T308-LR	0.8	0.08-0.50	0.05-0.25	○																							
CCGW120404-LL	0.4	0.08-0.50	0.05-0.20	○																							
CCGW120404-LR	0.4	0.08-0.50	0.05-0.20	○																							
CCGW120408-LL	0.8	0.08-0.50	0.05-0.25	○																							
CCGW120408-LR	0.8	0.08-0.50	0.05-0.25	○																							

● Ex stock ○ On demand

DP Polycrystalline diamond

Tool holder						
SCACR/L	SCLCR/L	SCACR/L-SC	SCLCR/L-SC	A***-SCLCR/L	S***-SCFCR/L	S***-SCLCR
Kr: 90°	Kr: 95°	Kr: 90°	Kr: 95°	Kr: 95°	Kr: 90°	Kr: 95°
A269	A270	A306	A307	A334	A352	A353

E***-SCLCR/L
Kr: 95°
A355

System code > A158

Grade selection > A42

Technical info > A501

Cutting data > A366



A

Turning

Turning PCD inserts

- Ideal machining conditions
- Normal machining conditions
- Unfavourable machining conditions

DCGT	L	I.C	S	d
07 02	7.8	6.35	2.38	2.8
11 T3	11.6	9.525	3.97	4.4

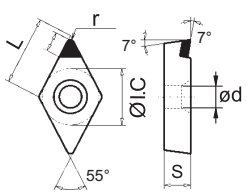
DC** positive insert		DP												
	P													
	M													
	K													
	N	●												
	S													
	H													

B

Milling

ISO	r	a _p	f	YCD421														
						DCGT070202F-1	0.2	0.08-0.50	0.05-0.15	○								
	DCGT070204F-1	0.4	0.08-0.50	0.05-0.20	○													
	DCGT11T302F-1	0.2	0.08-0.50	0.05-0.15	●													
	DCGT11T304F-1	0.4	0.08-0.50	0.05-0.20	●													
	DCGT11T308F-1	0.8	0.08-0.50	0.05-0.25	○													



● Ex stock ○ On demand

DP Polycrystalline diamond

C

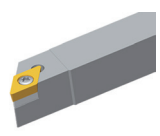
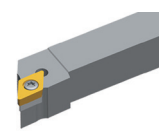
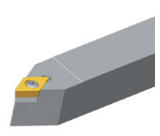
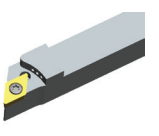
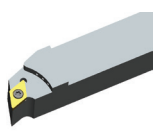
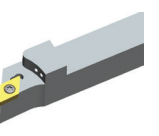
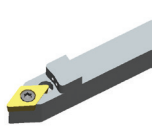
Drilling

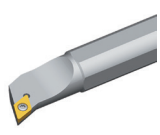
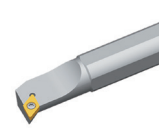
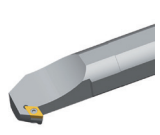
Tool holder						
SDACR/L	SDJCR/L	SDNCN	SDACR/L-SC	SDHCR/L-SC	SDJCR/L-SC	SDNCN-SC
Kr: 90°	Kr: 93°	Kr: 62°30'	Kr: 90°	Kr: 107°30'	Kr: 93°	Kr: 62°30'
						
A271	A272	A273	A308	A309	A310	A311

S***-SDQCR/L	A***-SDUCR/L	S***-SDZCR/L	E***-SDQCR/L
Kr: 107°30'	Kr: 93°	Kr: 85°	Kr: 107°30'
			
A336	A337	A338	A357

D

Technical Information

E

Index



System code > A158

Grade selection > A42









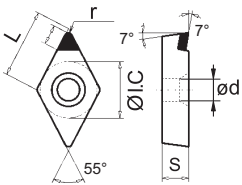

Technical info > A501

Cutting data > A366

Turning PCD inserts





-  Ideal machining conditions
-  Normal machining conditions
-  Unfavourable machining conditions

DCGT	L	I.C	S	d
07 02	7.8	6.35	2.38	2.8
11 T3	11.6	9.525	3.97	4.4

DC** positive insert				DP																	
				P																	
				M																	
				K																	
				N																	
				S																	
				H																	
ISO	r	a _p	f	YCD421																	
	DCGT070202F-1MED	0.2	0.08-0.50	0.05-0.15																	
	DCGT070204F-1MED	0.4	0.08-0.50	0.05-0.20																	
	DCGT070208F-1MED	0.8	0.08-0.50	0.05-0.25																	
	DCGT11T302F-1MED	0.2	0.08-0.50	0.05-0.15																	
	DCGT11T304F-1MED	0.4	0.08-0.50	0.05-0.20																	
	DCGT11T308F-1MED	0.8	0.08-0.50	0.05-0.25																	

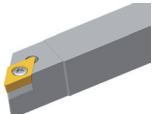
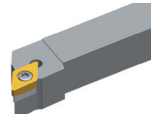
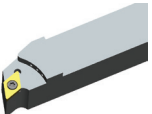
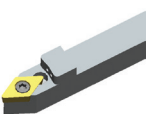
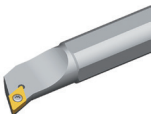
● Ex stock ○ On demand

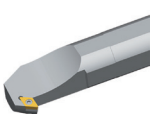
DP Polycrystalline diamond

Tool holder						
SDACR/L	SDJCR/L	SDNCN	SDACR/L-SC	SDHCR/L-SC	SDJCR/L-SC	SDNCN-SC
Kr: 90°	Kr: 93°	Kr: 62°30'	Kr: 90°	Kr: 107°30'	Kr: 93°	Kr: 62°30'
						
A271	A272	A273	A308	A309	A310	A311
S***-SDQCR/L	A***-SDUCR/L	S***-SDZCR/L	E***-SDQCR/L			
Kr: 107°30'	Kr: 93°	Kr: 85°	Kr: 107°30'			
						
A336	A337	A338	A357			

A

Turning

- Ideal machining conditions
- ⊗ Normal machining conditions
- ⊙ Unfavourable machining conditions

DCGW	L	I.C	S	d
07 02	7.8	6.35	2.38	2.8
11 T3	11.6	9.525	3.97	4.4

Turning PCD inserts

DC** positive insert	DP									
	P									
	M									
	K									
	N									
	S									
	H									

B

Milling

ISO	r	a _p	f	YCD421															
						DCGW070202F-1	0.2	0.08-0.50	0.05-0.15	●									
	DCGW070204F-1	0.4	0.08-0.50	0.05-0.20	●														
	DCGW070208F-1	0.8	0.08-0.50	0.05-0.25	○														
	DCGW11T302F-1	0.2	0.08-0.50	0.05-0.15	●														
	DCGW11T304F-1	0.4	0.08-0.50	0.05-0.20	●														

● Ex stock ○ On demand DP Polycrystalline diamond

C

Drilling

Tool holder						
SDACR/L	SDJCR/L	SDNCN	SDACR/L-SC	SDHCR/L-SC	SDJCR/L-SC	SDNCN-SC
Kr: 90°	Kr: 93°	Kr: 62°30'	Kr: 90°	Kr: 107°30'	Kr: 93°	Kr: 62°30'
A271	A272	A273	A308	A309	A310	A311

S***-SDQCR/L	A***-SDUCR/L	S***-SDZCR/L	E***-SDQCR/L
Kr: 107°30'	Kr: 93°	Kr: 85°	Kr: 107°30'
A336	A337	A338	A357

D



Technical Information

E





Index



Turning PCD inserts

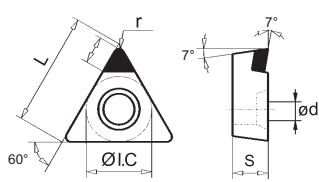

-  Ideal machining conditions
-  Normal machining conditions
-  Unfavourable machining conditions

TCGT	L	I.C	S	d
11 02	11	6.35	2.38	2.8
16 T3	16.5	9.525	3.97	4.4

TC** positive insert				DP																					
				P																					
				M																					
				K																					
				N																					
				S																					
				H																					
ISO	r	a _p	f	YCD421																					
	TCGT110202F-1	0.2	0.08-0.50	0.05-0.15	○																				
	TCGT110204F-1	0.4	0.08-0.50	0.05-0.20	○																				
	TCGT110208F-1	0.8	0.08-0.50	0.05-0.25	○																				
	TCGT16T302F-1	0.2	0.08-0.50	0.05-0.15	○																				
	TCGT16T304F-1	0.4	0.08-0.50	0.05-0.20	○																				
	TCGT16T308F-1	0.8	0.08-0.50	0.05-0.25	○																				
	TCGT110202F-1MED	0.2	0.08-0.50	0.05-0.15	○																				
	TCGT110204F-1MED	0.4	0.08-0.50	0.05-0.20	○																				
	TCGT110208F-1MED	0.8	0.08-0.50	0.05-0.25	○																				
	TCGT16T302F-1MED	0.2	0.08-0.50	0.05-0.15	○																				
	TCGT16T304F-1MED	0.4	0.08-0.50	0.05-0.20	○																				
	TCGT16T308F-1MED	0.8	0.08-0.50	0.05-0.25	○																				

● Ex stock ○ On demand

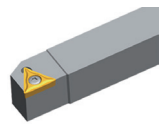
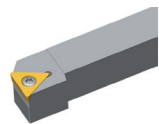
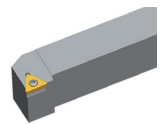
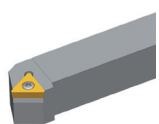
DP Polycrystalline diamond

Tool holder					
STACR/L	STFCR/L	STGCR/L	STTCR/L	S***-STFCR/L	E***-STFCR/L
Kr: 90°	Kr: 91°	Kr: 91°	Kr: 60°	Kr: 91°	Kr: 90°
					
A283	A284	A285	A286	A341	A361

A

Turning

- Ideal machining conditions
- Normal machining conditions
- Unfavourable machining conditions

TCGT	L	I.C	S	d
11 02	11	6.35	2.38	2.8
16 T3	16.5	9.525	3.97	4.4

Turning PCD inserts

TC** positive insert		DP									
	P										
	M										
	K										
	N										
	S										
	H										

B

Milling

ISO	r	a _p	f	YCD421	DP															
						TCGT110202-L	0.2	0.08-0.50	0.05-0.15											
	TCGT110204-L	0.4	0.08-0.50	0.05-0.20																
	TCGT110208-L	0.8	0.08-0.50	0.05-0.25																
	TCGT16T302-L	0.2	0.08-0.50	0.05-0.15																
	TCGT16T304-L	0.4	0.08-0.50	0.05-0.20																
	TCGT16T308-L	0.8	0.08-0.50	0.05-0.25																

● Ex stock ○ On demand

DP Polycrystalline diamond

C

Drilling

Tool holder					
STACR/L	STFCR/L	STGCR/L	STTCR/L	S***-STFCR/L	E***-STFCR/L
Kr: 90°	Kr: 91°	Kr: 91°	Kr: 60°	Kr: 91°	Kr: 90°
A283	A284	A285	A286	A341	A361

D



Technical Information

E









Index

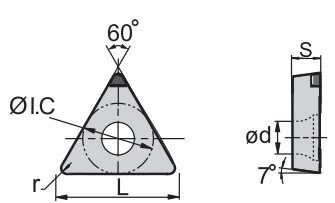

Turning PCD inserts



-  Ideal machining conditions
-  Normal machining conditions
-  Unfavourable machining conditions

TCGW	L	I.C	S	d
11 02	11	6.35	2.38	2.8
16 T3	16.5	9.525	3.97	4.4

TC** positive insert				DP																						
				P																						
				M																						
				K																						
				N																						
				S																						
				H																						
ISO	r	a _p	f	YCD421																						
	TCGW110202F-1	0.2	0.08-0.50	0.05-0.15																						
	TCGW110204F-1	0.4	0.08-0.50	0.05-0.20																						
	TCGW110208F-1	0.8	0.08-0.50	0.05-0.25																						
	TCGW16T304F-1	0.4	0.08-0.50	0.05-0.20																						
	TCGW16T308F-1	0.8	0.08-0.50	0.05-0.25																						
	TCGW16T312F-1	1.2	0.08-0.50	0.05-0.30																						

● Ex stock ○ On demand

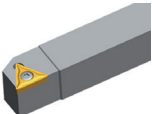
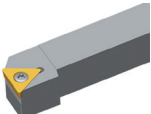
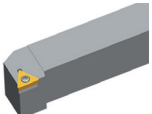
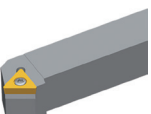
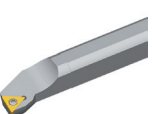
DP Polycrystalline diamond

Tool holder					
STACR/L	STFCR/L	STGCR/L	STTCR/L	S***-STFCR/L	E***-STFCR/L
Kr: 90°	Kr: 91°	Kr: 91°	Kr: 60°	Kr: 91°	Kr: 90°
					
A283	A284	A285	A286	A341	A361

System code > A158

Grade selection > A42

Technical info > A501

Cutting data > A366



A

Turning

B

Milling

C

Drilling

D

Technical Information

E

Index

A

Turning

- Ideal machining conditions
- ⊗ Normal machining conditions
- ⊗ Unfavourable machining conditions

TCGW	L	I.C	S	d
11 02	11	6.35	2.38	2.8
16 T3	16.5	9.525	3.97	4.4

Turning PCD inserts

TC** positive insert		DP									
	P										
	M										
	K										
	N	●									
	S										
H											

B

Milling

ISO	r	a _p	f	YCD421	DP										
	TCGW110202-L	0.2	0.08-0.50	0.05-0.15	○										
	TCGW110204-L	0.4	0.08-0.50	0.05-0.20	○										
	TCGW110208-L	0.8	0.08-0.50	0.05-0.25	○										
	TCGW16T302-L	0.2	0.08-0.50	0.05-0.15	○										
	TCGW16T304-L	0.4	0.08-0.50	0.05-0.20	○										
	TCGW16T308-L	0.8	0.08-0.50	0.05-0.25	○										

● Ex stock ○ On demand DP Polycrystalline diamond

C

Drilling

Tool holder					
STACR/L	STFCR/L	STGCR/L	STTCR/L	S***-STFCR/L	E***-STFCR/L
Kr: 90°	Kr: 91°	Kr: 91°	Kr: 60°	Kr: 91°	Kr: 90°
A283	A284	A285	A286	A341	A361

D



Technical Information

E











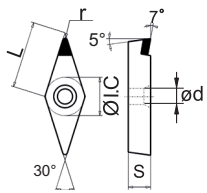

Index



Turning PCD inserts



-  Ideal machining conditions
-  Normal machining conditions
-  Unfavourable machining conditions

VBGT	L	I.C	S	d
11 03	11	6.35	3.18	2.8
16 04	16.6	9.525	4.76	4.4

VB** positive insert				DP																							
				P																							
				M																							
				K																							
				N																							
				S																							
				H																							
ISO	r	a _p	f	YCD421																							
	VBGT110302F-1	0.2	0.08-0.50	0.05-0.15																							
	VBGT110304F-1	0.4	0.08-0.50	0.05-0.20																							
	VBGT110308F-1	0.8	0.08-0.50	0.05-0.25																							
	VBGT160402F-1	0.2	0.08-0.50	0.05-0.15																							
	VBGT160404F-1	0.4	0.08-0.50	0.05-0.20																							
	VBGT160408F-1	0.8	0.08-0.50	0.05-0.25																							
	VBGT160404F-1MED	0.4	0.08-0.50	0.05-0.20																							
	VBGT160408F-1MED	0.8	0.08-0.50	0.05-0.25																							

● Ex stock ○ On demand

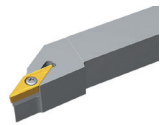
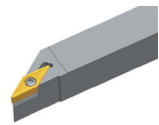
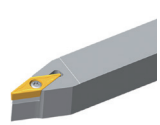
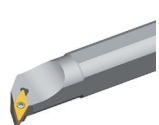
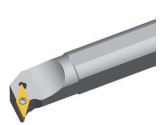
DP Polycrystalline diamond

Tool holder					
SVJBR/L	SVABR/L	SVVBN	S***-SVQBR/L	S***-SVUBR/L	S***-SVXBR/L
Kr: 93°	Kr: 90°	Kr: 72°30'	Kr: 107°30'	Kr: 93°	Kr: 93°
					
A274	A275	A276	A345	A346	A347

System code > A158

Grade selection > A42

Technical info > A501

Cutting data > A366



A

Turning

- Ideal machining conditions
- Normal machining conditions
- ⊛ Unfavourable machining conditions

VBGW	L	I.C	S	d
11 03	11	6.35	3.18	2.8
16 04	16.6	9.525	4.76	4.4

Turning PCD inserts

VB** positive insert		DP
	P	
	M	
	K	
	N	○
	S	
	H	

B

Milling

ISO	r	a _p	f	YCD421																		
	VBGW110302F-1	0.2	0.08-0.50	0.05-0.15	○																	
	VBGW110304F-1	0.4	0.08-0.50	0.05-0.20	●																	
	VBGW160402F-1	0.2	0.08-0.50	0.05-0.15	○																	
	VBGW160404F-1	0.4	0.08-0.50	0.05-0.20	●																	
	VBGW160408F-1	0.8	0.08-0.50	0.05-0.25	○																	

● Ex stock ○ On demand DP Polycrystalline diamond

C

Drilling

Tool holder					
SVJBR/L	SVABR/L	SVVBN	S***-SVQBR/L	S***-SVUBR/L	S***-SVXBR/L
Kr: 93°	Kr: 90°	Kr: 72°30'	Kr: 107°30'	Kr: 93°	Kr: 93°
A274	A275	A276	A345	A346	A347

D

Technical Information

E

Index

- Ideal machining conditions
- Normal machining conditions
- Unfavourable machining conditions

VCGT	L	I.C	S	d
11 02	11	6.35	2.38	2.8
16 04	16.6	9.525	4.76	4.4

Turning PCD inserts

VC** positive insert				DP																						
				P																						
				M																						
				K																						
				N	○																					
				S																						
				H																						
ISO	r	a _p	f	YCD421																						
	VCGT110202F-1	0.2	0.08-0.50	0.05-0.15	○																					
	VCGT110204F-1	0.4	0.08-0.50	0.05-0.20	○																					
	VCGT160402F-1	0.2	0.08-0.50	0.05-0.15	○																					
	VCGT160404F-1	0.4	0.08-0.50	0.05-0.20	○																					
	VCGT160408F-1	0.8	0.08-0.50	0.05-0.25	○																					

● Ex stock ○ On demand

DP Polycrystalline diamond

Tool holder						
SVVCN	SVJCR/L	SVACR/L-SC	SVJCR/L-SC	S***-SVQCR/L	S***-SVUCR/L	C***-SVQCR/L
Kr: 72°30'	Kr: 93°	Kr: 90°	Kr: 93°	Kr: 107°30'	Kr: 93°	Kr: 107°30'
A277	A278	A312	A313	A343	A344	A363

C***-SVUCR/L
Kr: 93°
A364



A

Turning

B

Milling

C

Drilling

D

Technical Information



E

Index



A

Turning

Turning PCD inserts



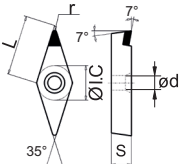



-  Ideal machining conditions
-  Normal machining conditions
-  Unfavourable machining conditions

VCGT	L	I.C	S	d
11 03	11	6.35	3.18	2.8
16 04	16.6	9.525	4.76	4.4

VC** positive insert		DP																					
	P																						
	M																						
	K																						
	N																						
	S																						
	H																						

B

Milling



ISO	r	a _p	f	YCD421																		
 VCGT110302F-1MED	0.2	0.08-0.50	0.05-0.15																			
VCGT110304F-1MED	0.4	0.08-0.50	0.05-0.20																			
VCGT160404F-1MED	0.4	0.08-0.50	0.05-0.20																			
VCGT160408F-1MED	0.8	0.08-0.50	0.05-0.25																			
VCGT160412F-1MED	1.2	0.08-0.50	0.05-0.30																			

● Ex stock ○ On demand

DP Polycrystalline diamond

C

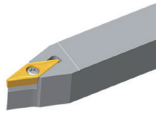
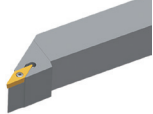
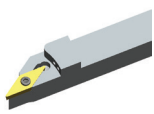
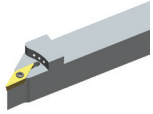
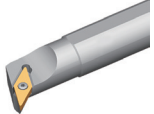
Drilling

Tool holder						
SVVCN Kr: 72°30'	SVJCR/L Kr: 93°	SVACR/L-SC Kr: 90°	SVJCR/L-SC Kr: 93°	S***-SVQCR/L Kr: 107°30'	S***-SVUCR/L Kr: 93°	C***-SVQCR/L Kr: 107°30'
						
A277	A278	A312	A313	A343	A344	A363

C***-SVUCR/L

Kr: 93°

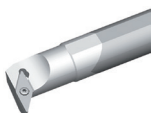

A364

D

Technical Information

E

Index

System code > A158

Grade selection > A42

Technical info > A501

Cutting data > A366

Turning PCD inserts

- Ideal machining conditions
- Normal machining conditions
- Unfavourable machining conditions

VCGW	L	I.C	S	d
11 03	11	6.35	3.18	2.8
16 04	16.6	9.525	4.76	4.4

VC** positive insert					DP																	
					P																	
					M																	
					K																	
					N	○																
					S																	
					H																	
ISO	r	a _p	f	YCD421																		
	VCGW110302F-1	0.2	0.08-0.50	0.05-0.15	○																	
	VCGW110304F-1	0.4	0.08-0.50	0.05-0.20	○																	
	VCGW160404F-1	0.4	0.08-0.50	0.05-0.20	○																	
	VCGW160408F-1	0.8	0.08-0.50	0.05-0.25	○																	

● Ex stock ○ On demand

DP Polycrystalline diamond

Tool holder						
SVVCN	SVJCR/L	SVACR/L-SC	SVJCR/L-SC	S***-SVQCR/L	S***-SVUCR/L	C***-SVQCR/L
Kr: 72°30'	Kr: 93°	Kr: 90°	Kr: 93°	Kr: 107°30'	Kr: 93°	Kr: 107°30'
A277	A278	A312	A313	A343	A344	A363

C***-SVUCR/L
Kr: 93°
A364



A

Turning

B

Milling

C

Drilling

D

Technical Information

E

Index

A

Turning

- Ideal machining conditions
- ⊗ Normal machining conditions
- ⊗ Unfavourable machining conditions

VCGX	L	I.C	S	d
22 05	22	12.7	5.56	5.5

Turning PCD inserts

VC** positive insert		DP									
	P										
	M										
	K										
	N	●									
	S										
	H										

B

Milling

ISO	r	a _p	f	YCD421																
VCGX220530-1	3	0.5-7.0	0.25-1.00	○																

● Ex stock ○ On demand

DP Polycrystalline diamond

C

Drilling

D

Technical Information

E

Index



Notes

Dotted lines for writing notes.

A
Turning

B
Milling

C
Drilling

D
Technical Information

E
Index

T N G A 12 04 08 T 020 20

1 2 3 4 5 6 7 8 9 10

A

Turning

B

Milling

C















Drilling









D

Technical Information

E

Index

Insert shape		
A 	B 	C 
D 	E 	H 
K 	L 	M 
P 	S 	T 
V 	W 	Z Special



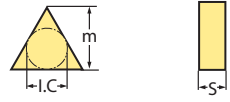



Clearance angle	
A 	B 
C 	D 
E 	F 
G 	N 
P 	O Special







Tolerance class			
			
Code	I.C [mm]	m [mm]	S [mm]
A	±0,025	±0,005	±0,025
C	±0,025	±0,013	±0,025
E	±0,025	±0,025	±0,025
F	±0,013	±0,005	±0,025
G	±0,025	±0,025	±0,130
H	±0,013	±0,013	±0,025
J	±0,05-0,15	±0,005	±0,025
K	±0,05-0,15	±0,013	±0,025
L	±0,05-0,15	±0,025	±0,025
M	±0,05-0,15	±0,08-0,20	±0,130
N	±0,05-0,15	±0,08-0,20	±0,025
U	±0,08-0,25	±0,13-0,38	±0,130

1

2

3

Fastening features (metric)	
Insert shape	
A 	B 
C 	N 
Q 	W 
X	Special

Cutting edge length l [mm]						
I.C [mm]	Insert shape					
						
3,97				06		
5,0				09		
5,56				09		
6,0				09		
6,35	06	07		11	11	
8,0				09		
9,525	09	11	09	16	16	06
10,0				09		
12,0				09		
12,7	12	15	12	22	22	08
15,875	16		15	27		
16,0		19				
19,05	19		19	33		
20,0				09		
25,0	25	25				
25,4			25			
31,75				09		
32				09		

4



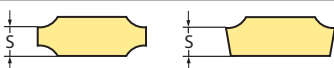

5

Insert thickness S [mm]			
			
Code	S	Code	S
02	2,38	06	6,35
T2	2,58	T6	6,75
03	3,18	07	7,94
T3	3,97	09	9,52
04	4,76	T9	9,72
T4	4,96	11	11,11
05	5,56	12	12,70
T5	5,95		

6

Nose radius r [mm]	
	
Code	r
00	–
02	0,2
04	0,4
08	0,8
12	1,2
16	1,6
20	2,0
24	2,4
32	3,2
X	Special
MO	Plaquettes rondes

7

Cutting edge profile		
Code	Cutting edge	Insert shape
E	Rounding	
F	Sharp edge	
T	Chamfer	
S	Chamfer + Rounding	

8

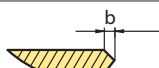
Chamfer width b [mm]	
	
Code	b
010	0,10
015	0,15
020	0,20
025	0,25
030	0,30
035	0,35
040	0,40
045	0,45
050	0,50
100	1,00
200	2,00

9

Angle du chanfrein α	
	
Code	α
05	5°
10	10°
15	15°
20	20°
25	25°
30	30°

10

A

Turning

B

Milling

C

Drilling

D

Technical Information

E

Index

A

Turning

B

Milling

C

Drilling

D

Technical Information

E

Index

- Ideal machining conditions
- ⊗ Normal machining conditions
- ⊗ Unfavourable machining conditions

CNGA	L	I.C	S	d
12 04	12.9	12.7	4.76	5.16
16 06	16.1	15.875	6.35	6.35

Turning ceramic inserts

CN** negative insert		CM	CC	CN	CR
	P	●			
	M				
	K	●		⊗	
	N				
	S			●	⊗
	H		○		

ISO	r	a _p	f	CA1000	CM1000	CN1000 CS1000	CW1400 CW1800
CNGA120404S02020	0.4	0.1-0.3	0.08-0.25		●		
CNGA120404T01020	0.4	0.1-0.3	0.08-0.25		○		
CNGA120404T02020	0.4	0.1-0.3	0.08-0.25	○	●	●	
CNGA120408S01520	0.8	0.1-0.25	0.5-2.5				○
CNGA120408S02020	0.8	0.1-0.4	0.1-0.3		●		
CNGA120408T00520	0.8	0.1-0.25	0.5-2.5				○ ●
CNGA120408T01020	0.8	0.1-0.4	0.1-0.3		○		
CNGA120408T02020	0.8	0.1-0.4	0.1-0.3	○	●	○	
CNGA120412S01520	1.2	0.1-0.3	0.5-2.5				○
CNGA120412S02020	1.2	0.1-0.5	0.1-0.3		●		
CNGA120412T00520	1.2	0.1-0.3	0.5-2.5				○
CNGA120412T02020	1.2	0.1-0.5	0.1-0.3	○	○	●	
CNGA120416S01520	1.6	0.1-0.35	0.5-3.0				○
CNGA120416T00520	1.6	0.1-0.35	0.5-3.0				○ ○
CNGA160612T02020	1.2	0.2-2.0	0.1-0.3			●	

● Ex stock ○ On demand

CM Mixed ceramic
 CC Mixed ceramic, coated
 CN Si3N4 Ceramic
 CR Al2O3 cutting ceramic, reinforced

Tool holder					
DCLNR/L	PCBNR/L	PCLNR/L	MCBNR/L	MCLNR/L	S***-PCLNR/L
Kr: 95°	Kr: 75°	Kr: 95°	Kr: 75°	Kr: 95°	Kr: 95°
A230	A237	A238	A252	A253	A324



CNGN	L	I.C	S
12 07	12.9	12.7	7.94
12 04	12.9	12.7	4.76
16 06	16.1	15.875	6.35
16 07	16.1	15.875	7.94

- Ideal machining conditions
- ⊗ Normal machining conditions
- ⊗ Unfavourable machining conditions

Turning ceramic inserts

CN** negative insert				CM	CC	CN	CR
	P	●					
	M						
	K	●			⊗		
	N						
	S					●	⊗
	H				○		

ISO	r	a _p	f	CA1000	CM1000	CN1000 CS1000	CW1400 CW1800
CNGN120404T00520	0.4	0.1-0.25	0.5-2.0				○
CNGN120404T02020	0.4	0.1-0.3	0.08-0.25	○			
CNGN120408S01520	0.8	0.1-0.25	0.5-2.5				○
CNGN120408S02020	0.8	0.1-0.4	0.1-0.3		○		
CNGN120408T00520	0.8	0.1-0.25	0.5-2.5				●
CNGN120408T02020	0.8	0.1-0.4	0.1-0.3	●		●	
CNGN120412S01520	1.2	0.1-0.3	0.5-2.5				○
CNGN120412T00520	1.2	0.1-0.3	0.5-2.5				●
CNGN120412T02020	1.2	0.1-0.5	0.1-0.3	○		○	
CNGN120416S01520	1.6	0.1-0.35	0.5-3.0				○
CNGN120416T00520	1.6	0.1-0.35	0.5-3.0				●
CNGN120416T02020	1.6	0.5-2.0	0.1-0.35			○	
CNGN120708S01520	0.8	0.1-0.25	0.5-2.5				○
CNGN120708T00520	0.8	0.1-0.25	0.5-2.5				●
CNGN120708T02020	0.8	0.1-0.4	0.1-0.3	○			
CNGN120712S01520	1.2	0.1-0.3	0.5-2.5				○
CNGN120712S02025	1.2	0.1-0.3	0.5-2.5				○
CNGN120712T00520	1.2	0.1-0.3	0.5-2.5				●
CNGN120712T00525	1.2	0.1-0.3	0.5-2.5			○	○
CNGN120712T02020	1.2	0.1-0.5	0.1-0.3	●		○	
CNGN120716S01520	1.6	0.1-0.35	0.5-3.0				○
CNGN120716T00520	1.6	0.1-0.35	0.5-3.0				○
CNGN120716T01520	1.6	0.1-0.35	0.5-3.0				○
CNGN120716T02020	1.6	0.1-0.6	0.1-0.4	○		○	
CNGN160616T02020	1.6	0.1-0.6	0.1-0.4	○			
CNGN160712T01525	1.2	0.2-2.0	0.1-0.3			○	
CNGN160716T01525	1.6	0.1-0.6	0.1-0.4	○			
CNGN160716T02020	1.6	0.5-2.0	0.1-0.35			○	

● Ex stock ○ On demand

CM Mixed ceramic
 CC Mixed ceramic, coated
 CN Si3N4 Ceramic
 CR Al2O3 cutting ceramic, reinforced



A

Turning

B

Milling

C

Drilling

D

Technical Information

E

Index

A

Tool holder

CCLNR/L

Kr: 95°



A292

Turning

B

Milling

C

Drilling

D

Technical
Information

E

Index

System code > A198

Grade selection > A42

Technical info > A501

Cutting data > A366

- Ideal machining conditions
- ⊗ Normal machining conditions
- ⊗ Unfavourable machining conditions

CNGX	L	I.C	S
12 07	12.9	12.7	7.94

Turning ceramic inserts

CN** negative insert					CM	CC	CN	CR
	P	●						
	M							
	K	●				⊗		
	N							
	S						●	⊗
	H					○		
ISO	r	a _p	f	CA1000	CM1000	CN1000 CS1000	CW1400 CW1800	
	CNGX120712T02020	1.2	0.2-2.0	0.1-0.3		●		
	CNGX120716T02020	1.6	0.5-2.0	0.1-0.35		○		

● Ex stock ○ On demand

CM Mixed ceramic
 CC Mixed ceramic, coated
 CN Si3N4 Ceramic
 CR Al2O3 cutting ceramic, reinforced

Tool holder
JCLNR/L
 Kr: 95°

A300

A

Turning

B

Milling

C

Drilling

D

Technical Information

E

Index



A

Turning

B

Milling

C

Drilling

D

Technical Information

E

Index

- Ideal machining conditions
- ⊗ Normal machining conditions
- ⊗ Unfavourable machining conditions

DNGA	L	I.C	S	d
15 06	15.5	12.7	6.35	5.16
15 04	15.5	12.7	4.76	5.16

Turning ceramic inserts

DN** negative insert				CM	CC	CN	CR
	P	●					
	M						
	K	●			⊗		
	N						
	S					●	⊗
	H				○		
ISO	r	a _p	f	CA1000	CM1000	CN1000 CS1000	CW1400 CW1800
DNGA150404T02020	0.4	0.1-0.3	0.08-0.25		○		
DNGA150408S01520	0.8	0.1-0.25	0.5-2.5				○
DNGA150408T00520	0.8	0.1-0.25	0.5-2.5				●
DNGA150408T02020	0.8	0.1-0.4	0.1-0.3		○		
DNGA150412S01520	1.2	0.1-0.3	0.5-2.5				○
DNGA150412T00520	1.2	0.1-0.3	0.5-2.5				●
DNGA150412T02020	1.2	0.1-0.5	0.1-0.3		○	○	○
DNGA150416S01520	1.6	0.1-0.35	0.5-3.0				○
DNGA150416T00520	1.6	0.1-0.35	0.5-3.0				○
DNGA150604S02020	0.4	0.1-0.3	0.08-0.25		●		
DNGA150604T01020	0.4	0.1-0.3	0.08-0.25		○		
DNGA150604T02020	0.4	0.1-0.3	0.08-0.25		●	○	
DNGA150608S02020	0.8	0.1-0.4	0.1-0.3		●		
DNGA150608T02020	0.8	0.1-0.4	0.1-0.3		○	●	
DNGA150612S02020	1.2	0.1-0.5	0.1-0.3		●		
DNGA150612T01020	1.2	0.1-0.5	0.1-0.3		○		
DNGA150612T02020	1.2	0.1-0.5	0.1-0.3		●	○	
DNGA150616T02020	1.6	0.5-2.0	0.1-0.35			○	

● Ex stock ○ On demand

CM Mixed ceramic
 CC Mixed ceramic, coated
 CN Si3N4 Ceramic
 CR Al2O3 cutting ceramic, reinforced

Tool holder						
DDJNR/L	PDJNR/L	PDNNR/L	MDJNR/L	MDPNN	S***-PDSNR/L	S***-PDUNR/L
Kr: 93°	Kr: 93°	Kr: 63°	Kr: 93°	Kr: 62°30'	Kr: 62°30'	Kr: 93°
A231	A240	A241	A254	A255	A326	A327



- Ideal machining conditions
- ⊗ Normal machining conditions
- ⊗ Unfavourable machining conditions

DNGN	L	I.C	S
15 04	15.5	12.7	4.76
15 07	15.5	12.7	7.94

Turning ceramic inserts

DN** negative insert					CM	CC	CN	CR
	P	●						
	M							
	K	●				⊗		
	N							
	S						●	⊗
	H					○		
ISO	r	a _p	f	CA1000	CM1000	CN1000 CS1000	CW1400 CW1800	
DNGN150408S01520	0.8	0.1-0.25	0.5-2.5				○	
DNGN150408T00520	0.8	0.1-0.25	0.5-2.5				●	
DNGN150408T02020	0.8	0.1-0.4	0.1-0.3	○	○			
DNGN150412S01520	1.2	0.1-0.3	0.5-2.5				○	
DNGN150412T00520	1.2	0.1-0.3	0.5-2.5				●	
DNGN150412T02020	1.2	0.1-0.5	0.1-0.3	○				
DNGN150416S01520	1.6	0.1-0.35	0.5-3.0				○	
DNGN150416T00520	1.6	0.1-0.35	0.5-3.0				○	
DNGN150704T02020	0.4	0.1-0.3	0.08-0.25	○		○		
DNGN150708T01520	0.8	0.1-0.25	0.5-2.5				○	
DNGN150708T02020	0.8	0.1-0.4	0.1-0.3	●		○		
DNGN150712T02020	1.2	0.1-0.5	0.1-0.3	○		○		
DNGN150716T01520	1.6	0.1-0.35	0.5-3.0				○	
DNGN150716T02020	1.6	0.1-0.6	0.1-0.4	○				

● Ex stock ○ On demand

CM Mixed ceramic
 CC Mixed ceramic, coated
 CN Si3N4 Ceramic
 CR Al2O3 cutting ceramic, reinforced

Tool holder
CDJNR/L
 Kr: 93°

A294

A

Turning

B

Milling

C

Drilling

D

Technical Information

E

Index



A

Turning

- Ideal machining conditions
- ⊗ Normal machining conditions
- ⊗ Unfavourable machining conditions

DNGX	L	I.C	S
15 07	15.5	12.7	7.94

Turning ceramic inserts

DN** negative insert				CM	CC	CN	CR
	P	●					
	M						
	K	●			⊗		
	N						
	S				●	⊗	⊗
	H				○		

B

Milling

ISO	r	a _p	f	CA1000	CM1000	CN1000 CS1000	CW1400 CW1800
	DNGX150708T02020	0.8	0.15-1.5	0.1-0.25		○	
	DNGX150712T02020	1.2	0.2-2.0	0.1-0.3		○	
	DNGX150716T02020	1.6	0.5-2.0	0.1-0.35		○	

● Ex stock ○ On demand

- CM Mixed ceramic
- CC Mixed ceramic, coated
- CN Si3N4 Ceramic
- CR Al2O3 cutting ceramic, reinforced

C

Drilling

Tool holder

JDJNR/L

Kr: 93°

A301

D

Technical Information

E

Index



- Ideal machining conditions
- ⊗ Normal machining conditions
- ⊗ Unfavourable machining conditions

RNGA	I.C	S	d
12 04	12.7	4.76	

Turning ceramic inserts

RN** negative insert			CM	CC	CN	CR
	P	●				
	M	●				
	K	●			⊗	
	N	●				
	S	●			●	⊗
	H	●		○		
ISO	a _p	f	CA1000	CM1000	CN1000 CS1000	CW1400 CW1800
	RNGA120400T02020	0.1-0.6	0.1-0.4	○		

● Ex stock ○ On demand

CM Mixed ceramic
 CC Mixed ceramic, coated
 CN Si3N4 Ceramic
 CR Al2O3 cutting ceramic, reinforced

Tool holder	
MRDNN	MRGNR/L
A267	A268

A

Turning

B

Milling

C

Drilling

D

Technical Information

E



Index



A

Turning







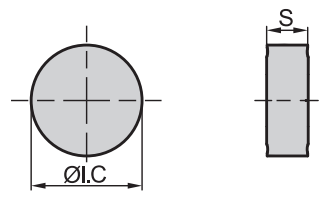

RNGN	I.C	S
06 03	6.35	3.18
09 04	9.525	4.76
09 03	9.525	3.18
12 07	12.7	7.94
12 04	12.7	4.76
15 07	15.875	7.94
19 07	19.05	7.94
25 07	25.4	7.94
25 10	25.4	10.05

-  Ideal machining conditions
-  Normal machining conditions
-  Unfavourable machining conditions

Turning ceramic inserts

B

Milling

RN** negative insert		CM	CC	CN	CR
	P				
	M				
	K				
	N				
	S				 
	H				

C

Drilling

ISO	a _p	f	CA1000	CM1000	CN1000 CS1000	CW1400 CW1800
RNGN060300T01020	0.1-0.3	0.08-0.25	○	○		
RNGN090300S01520	0.1-0.3	0.5-2.5				○
RNGN090300T00520	0.1-0.3	0.5-2.5				○ ○
RNGN090300T02020	0.1-0.3	0.1-0.3	○			
RNGN090400S01520	0.1-0.3	0.5-2.5				○
RNGN090400T00520	0.1-0.3	0.5-2.5				○
RNGN090400T02020	0.1-0.3	0.1-0.3	○			
RNGN120400S01520	0.1-0.35	0.5-3.0				○
RNGN120400S02020	0.1-0.6	0.1-0.4		●		
RNGN120400T00520	0.1-0.35	0.5-3.0				●
RNGN120400T01020	0.5-2.0	0.1-0.2			○	
RNGN120400T01525	0.1-0.6	0.1-0.4		○		
RNGN120400T02020	0.1-0.6	0.1-0.4	○		○	
RNGN120700S01520	0.1-0.35	0.5-3.0				○
RNGN120700S02020	0.1-0.6	0.1-0.4		●		
RNGN120700T00520	0.1-0.35	0.5-3.0				● ●
RNGN120700T00525	0.1-0.35	0.5-3.0			○	○ ○
RNGN120700T01520	0.1-0.35	0.5-3.0				○
RNGN120700T01525	0.2-2.0	0.1-0.3			○	
RNGN120700T02020	0.2-2.0	0.1-0.3	●		●	
RNGN150700T02020	0.1-0.6	0.1-0.5	○			
RNGN190700S01520	0.1-0.4	0.5-3.0				○
RNGN190700T00520	0.1-0.4	0.5-3.0				○
RNGN190700T03020	0.1-0.7	0.1-0.5	○			
RNGN250700T19015	0.1-0.7	0.1-0.8	○			
RNGN251000T05020	0.1-0.7	0.1-0.5	○			

● Ex stock ○ On demand

CM Mixed ceramic
 CC Mixed ceramic, coated
 CN Si3N4 Ceramic
 CR Al2O3 cutting ceramic, reinforced

D

Technical Information

E

Index



Tool holder

CRDNN

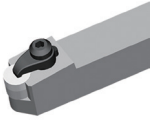

A298

A

Turning

B

Milling

C

Drilling

D

Technical
Information

E

Index

System code > A198

Grade selection > A42

Technical info > A501

Cutting data > A366



A

Turning

B

Milling

C

Drilling

D

Technical Information

E

Index

- Ideal machining conditions
- ⊗ Normal machining conditions
- ⊗ Unfavourable machining conditions

SNGA	L	I.C	S	d
12 04	12.7	12.7	4.76	5.16

Turning ceramic inserts

SN** negative insert					CM	CC	CN	CR
	P	●						
	M							
	K	●					⊗	
	N							
	S						●	⊗
	H					○		
ISO	r	a _p	f					
				CA1000		CM1000	CN1000 CS1000	CW1400 CW1800
	SNGA120404T02020	0.4	0.1-1.0	0.1-0.2			○	
	SNGA120408S02020	0.8	0.1-0.4	0.1-0.3		○		
	SNGA120408T02020	0.8	0.1-0.4	0.1-0.3	○	○	○	
	SNGA120412T02020	1.2	0.2-2.0	0.1-0.3			○	

● Ex stock ○ On demand

CM Mixed ceramic
 CC Mixed ceramic, coated
 CN Si3N4 Ceramic
 CR Al2O3 cutting ceramic, reinforced

C

Drilling

Tool holder						
DSBNR/L	PSBNR/L	PSDNN	PSKNR/L	PSSNR/L	MSBNR/L	MSRNR/L
Kr: 75°	Kr: 75°	Kr: 45°	Kr: 75°	Kr: 45°	Kr: 75°	Kr: 75°
A232	A242	A244	A245	A246	A256	A257
MSKNR/L	MSDNN	S***-PSKNR/L				
Kr: 75°	Kr: 45°	Kr: 75°				
A258	A259	A329				

System code > A198

Grade selection > A42

Technical info > A501

Cutting data > A366

SNGN	L	I.C	S
12 04	12.7	12.7	4.76
12 07	12.7	12.7	7.94
15 07	15.875	15.875	7.94
19 07	19.05	19.05	7.94

- Ideal machining conditions
- Normal machining conditions
- Unfavourable machining conditions

Turning ceramic inserts

SN** negative insert				CM	CC	CN	CR
	P	●					
	M						
	K	●			●		
	N						
	S					●	●
	H				○		
ISO	r	a _p	f	CA1000	CM1000	CN1000 CS1000	CW1400 CW1800
SNGN120404T02020	0.4	0.1-0.3	0.08-0.25	○			
SNGN120408S01520	0.8	0.1-0.25	0.5-2.5				○
SNGN120408S02020	0.8	0.1-0.4	0.1-0.3		○		
SNGN120408T00520	0.8	0.15-1.5	0.1-0.25			○	●
SNGN120408T02020	0.8	0.1-0.4	0.1-0.3	○		●	
SNGN120412S01520	1.2	0.1-0.3	0.5-2.5				○
SNGN120412T00520	1.2	0.1-0.3	0.5-2.5				●
SNGN120412T02020	1.2	0.1-0.5	0.1-0.3	○		○	
SNGN120416S01520	1.6	0.1-0.35	0.5-3.0				○
SNGN120416T00520	1.6	0.1-0.35	0.5-3.0				○
SNGN120416T02020	1.6	0.1-0.6	0.1-0.4	○		○	
SNGN120704T02020	0.4	0.1-0.3	0.08-0.25	●			
SNGN120708S01520	0.8	0.1-0.25	0.5-2.5				○
SNGN120708T00520	0.8	0.1-0.25	0.5-2.5				●
SNGN120708T02020	0.8	0.1-0.4	0.1-0.3	○	○	○	
SNGN120712S01520	1.2	0.1-0.3	0.5-2.5				○
SNGN120712T00520	1.2	0.1-0.3	0.5-2.5				●
SNGN120712T02020	1.2	0.1-0.5	0.1-0.3	○	○	●	
SNGN120716S01520	1.6	0.1-0.35	0.5-3.0				○
SNGN120716T00520	1.6	0.1-0.35	0.5-3.0				○
SNGN120716T01520	1.6	0.1-0.35	0.5-3.0				○
SNGN120716T02020	1.6	0.1-0.6	0.1-0.4	○			
SNGN150708T02020	0.8	0.1-0.4	0.1-0.3	○			
SNGN150712T02020	1.2	0.1-0.5	0.1-0.3	●		○	
SNGN150716T02020	1.6	0.1-0.6	0.1-0.4	●		○	
SNGN190716S02030	1.6	0.5-2.0	0.1-0.35			○	
SNGN190716T03020	1.6	0.1-0.6	0.1-0.4	○			

● Ex stock ○ On demand

CM Mixed ceramic
 CC Mixed ceramic, coated
 CN Si3N4 Ceramic
 CR Al2O3 cutting ceramic, reinforced

A

Turning

B

Milling

C

Drilling

D

Technical Information

E

Index



A

Turning

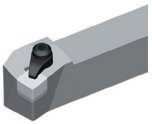
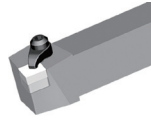
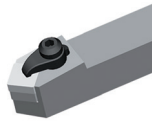
Tool holder		
CSKNR/L	CSRNR/L	CSDNN
Kr: 75°	Kr: 75°	Kr: 45°
		
A296	A297	A299

B

Milling

C

Drilling

D

Technical Information

E

Index

System code > A198

Grade selection > A42

Technical info > A501

Cutting data > A366

- Ideal machining conditions
- ⊗ Normal machining conditions
- ⊗ Unfavourable machining conditions

SNGX	L	I.C	S
12 07	12.7	12.7	7.94

Turning ceramic inserts

SN** negative insert					CM	CC	CN	CR
	P	●						
	M	●						
	K	●				⊗		
	N	●						
	S	●					●	⊗
	H	○				○		
ISO	r	a _p	f	CA1000	CM1000	CN1000 CS1000	CW1400 CW1800	
SNGX120712T02020	1.2	0.2-2.0	0.1-0.3			○		
SNGX120716T02020	1.6	0.5-2.0	0.1-0.35			○		

● Ex stock ○ On demand

CM Mixed ceramic
 CC Mixed ceramic, coated
 CN Si3N4 Ceramic
 CR Al2O3 cutting ceramic, reinforced

Tool holder

JSDNN

Kr: 45°

A302

A

Turning

B

Milling

C

Drilling

D

Technical Information

E

Index

A

Turning

- Ideal machining conditions
- ⊗ Normal machining conditions
- ⊗ Unfavourable machining conditions

TNGA	L	I.C	S	d
16 04	16.5	9.525	4.76	3.86
22 04	22	12.7	4.76	5.16

Turning ceramic inserts

TN** negative insert		CM	CC	CN	CR
	P	●			
	M				
	K	●		⊗	
	N				
	S			●	⊗
	H		○		

B

Milling

ISO	r	a _p	f	CA1000		CM1000		CN1000 CS1000		CW1400 CW1800	
				●	○	●	○	●	○	●	○
TNGA160404S02020	0.4	0.1-0.3	0.08-0.25			●					
TNGA160404T01020	0.4	0.1-0.3	0.08-0.25			○		●			
TNGA160404T02020	0.4	0.1-0.3	0.08-0.25			○					
TNGA160408S02020	0.8	0.1-0.4	0.1-0.3			●					
TNGA160408T02020	0.8	0.1-0.4	0.1-0.3			○		●			
TNGA160412T02020	1.2	0.1-0.5	0.1-0.3			○		●			
TNGA220408T02020	0.8	0.15-1.5	0.1-0.25					○			
TNGA220412T02020	1.2	0.2-2.0	0.1-0.3					○			
TNGA220416T02020	1.6	0.5-2.0	0.1-0.35					○			

● Ex stock ○ On demand

CM Mixed ceramic
 CC Mixed ceramic, coated
 CN Si3N4 Ceramic
 CR Al2O3 cutting ceramic, reinforced

C

Drilling

Tool holder						
DTGNR/L	PTFNR/L	PTTNR/L	PTGNR/L	MTGNR/L	MTJNR/L	MTJNR/L-Z
Kr: 91°	Kr: 91°	Kr: 60°	Kr: 90°	Kr: 90°	Kr: 93°	Kr: 93°
A233	A247	A248	A249	A260	A261	A262

D

Technical Information

MTFNR/L	S***-PTFNR/L
Kr: 91°	Kr: 90°
A263	A330

E

Index



TNGN	L	I.C	S
16 04	16.5	9.525	4.76
16 07	16.5	9.525	7.94
22 04	22	12.7	4.76

- Ideal machining conditions
- ⊗ Normal machining conditions
- ⊗ Unfavourable machining conditions

Turning ceramic inserts

TN** negative insert				CM	CC	CN	CR
	P	●					
	M						
	K	⊗			⊗		
	N						
	S				●	⊗ ⊗	
	H				○		
ISO	r	a _p	f	CA1000	CM1000	CN1000 CS1000	CW1400 CW1800
	TNGN160404T02020	0.4	0.1-0.3	0.08-0.25	○		
	TNGN160408S02020	0.8	0.1-0.4	0.1-0.3		○	
	TNGN160408T02020	0.8	0.1-0.4	0.1-0.3	○		○
	TNGN160412T02020	1.2	0.1-0.5	0.1-0.3	○		○
	TNGN160416T02020	1.6	0.5-2.0	0.1-0.35			○
	TNGN160708T02020	0.8	0.15-1.5	0.1-0.25			○
	TNGN160712T02020	1.2	0.1-0.5	0.1-0.3	○		
	TNGN220408T02020	0.8	0.1-0.4	0.1-0.3	○		○
	TNGN220412T02020	1.2	0.1-0.5	0.1-0.3	○		○
	TNGN220416T02020	1.6	0.1-0.6	0.1-0.4	○		○

● Ex stock ○ On demand

CM Mixed ceramic
 CC Mixed ceramic, coated
 CN Si3N4 Ceramic
 CR Al2O3 cutting ceramic, reinforced

Tool holder	
CTJNR/L	CTUNR/L
Kr: 93°	Kr: 93°
A293	A295

A

Turning

- Ideal machining conditions
- ⊗ Normal machining conditions
- ⊗ Unfavourable machining conditions

VNGA	L	I.C	S	d
16 07	16.6	9.525	7.94	3.81
16 04	16.6	9.525	4.76	3.81

Turning ceramic inserts

VN** negative insert		CM	CC	CN	CR
	P	●			
	M				
	K	●		⊗	
	N				
	S			●	⊗
	H		○		

B

Milling

ISO	r	a _p	f	CA1000		CM1000		CN1000 CS1000		CW1400 CW1800	
				●	○	●	○	●	○		
	VNGA160404S02020	0.4	0.1-0.3	0.08-0.25		●					
	VNGA160404T01020	0.4	0.1-0.3	0.08-0.25		○					
	VNGA160408S02020	0.4	0.1-0.4	0.1-0.3		●					
	VNGA160408T01020	0.8	0.1-0.4	0.1-0.3		○					
	VNGA160408T02020	0.8	0.1-0.4	0.1-0.3		●					
	VNGA160708S02020	0.8	0.1-0.4	0.1-0.3		●					

● Ex stock ○ On demand

CM Mixed ceramic
 CC Mixed ceramic, coated
 CN Si3N4 Ceramic
 CR Al2O3 cutting ceramic, reinforced

C

Drilling

Tool holder			
DVVNN	DVJNR/L	MVVNN	MVJNR/L
Kr: 72°30'	Kr: 93°	Kr: 72°30'	Kr: 93°
A234	A235	A264	A265

D

Technical Information

E

Index



- Ideal machining conditions
- ⊗ Normal machining conditions
- ⊗ Unfavourable machining conditions

WNGA	L	I.C	S	d
08 04	8.69	12.7	4.76	5.16

Turning ceramic inserts

WN** negative insert					CM	CC	CN	CR
	P	●						
	M							
	K	●				⊗		
	N							
	S						●	⊗
	H					○		
ISO	r	a _p	f	CA1000	CM1000	CN1000 CS1000	CW1400 CW1800	
	WNGA080404T01020	0.4	0.1-0.3	0.08-0.25		○		
	WNGA080404T02020	0.4	0.1-0.3	0.08-0.25		○		
	WNGA080408S02020	0.8	0.1-0.4	0.1-0.3		○		
	WNGA080408T02020	0.8	0.1-0.4	0.1-0.3		○	●	
	WNGA080412S02020	1.2	0.1-0.5	0.1-0.3		○		
	WNGA080412T02020	1.2	0.1-0.5	0.1-0.3		○	●	
	WNGA080416T01525	1.6	0.5-2.0	0.1-0.35			○	
	WNGA080416T02020	1.6	0.5-2.0	0.1-0.35			●	

● Ex stock ○ On demand

CM Mixed ceramic
 CC Mixed ceramic, coated
 CN Si3N4 Ceramic
 CR Al2O3 cutting ceramic, reinforced

Tool holder			
DWLNR/L	PWLNR/L	MWLNR/L	S***-PWLNR/L
Kr: 95°	Kr: 95°	Kr: 95°	Kr: 95°
A236	A251	A266	A332

A

Turning

B

Milling

C

Drilling

D

Technical Information

E

Index

RCGX	I.C	S	d
06 07	6	7.94	
06 04	6	4.76	
06 06	6	6.35	
09 07	9	7.94	
12 07	12	7.94	
19 10	19	10	

- Ideal machining conditions
- ⊗ Normal machining conditions
- ⊗ Unfavourable machining conditions

Turning ceramic inserts

RC** positive insert				CM	CC	CN	CR
	P	●					
	M						
	K	●			⊗		
	N	●					
	S	●			●	⊗ ⊗	
	H			○			
ISO	a _p	f	CA1000	CM1000	CN1000 CS1000	CW1400 CW1800	
RCGX060400S01520	0.1-0.25	0.5-2.5				○	
RCGX060400T00520	0.1-0.25	0.5-2.5				○	
RCGX060600S02020	0.1-0.3	0.08-0.25	○				
RCGX060600T01020	0.1-0.25	0.5-2.5				○	
RCGX060700T00525	0.1-0.25	0.5-2.5			○	○ ○	
RCGX090700S01520	0.1-0.3	0.5-2.5				○	
RCGX090700T00520	0.1-0.3	0.5-2.5				○	
RCGX090700T00525	0.1-0.3	0.5-2.5			○	○ ○	
RCGX090700T20015	0.1-0.3	0.1-0.3	○				
RCGX120700E	0.5-2.0	0.1-0.2			○		
RCGX120700S01020	0.5-2.0	0.1-0.2			○		
RCGX120700S01520	0.1-0.35	0.5-3.0				○	
RCGX120700T00520	0.1-0.35	0.5-3.0				○	
RCGX120700T00525	0.1-0.35	0.5-3.0			○	○ ○	
RCGX120700T01020	0.1-0.35	0.5-3.0		○		○	
RCGX191000T02020	0.1-0.6	0.1-0.5		○			

● Ex stock ○ On demand

CM Mixed ceramic
 CC Mixed ceramic, coated
 CN Si3N4 Ceramic
 CR Al2O3 cutting ceramic, reinforced



- Ideal machining conditions
- ⊗ Normal machining conditions
- ⊗ Unfavourable machining conditions

RPGN	I.C	S
12 04	12.7	4.76

Turning ceramic inserts

RP** positive insert			CM	CC	CN	CR
	P	●				
	M	●				
	K	●			⊗	
	N	●				
	S	●			●	⊗ ⊗
	H	●		○		
ISO	a_p	f	CA1000	CM1000	CN1000 CS1000	CW1400 CW1800
	RPGN120400S01520	0.1-0.35	0.5-3.0			○
	RPGN120400T00520	0.1-0.35	0.5-3.0			○

● Ex stock ○ On demand

CM Mixed ceramic
 CC Mixed ceramic, coated
 CN Si3N4 Ceramic
 CR Al2O3 cutting ceramic, reinforced

A

Turning

B

Milling

C

Drilling

D

Technical Information

E

Index

A

Turning

- Ideal machining conditions
- ✳ Normal machining conditions
- ✳✳ Unfavourable machining conditions

RPGX	I.C	S
09 07	9.525	7.94

Turning ceramic inserts

RP** positive insert				CM	CC	CN	CR
	P	●					
	M						
	K	●			✳		
	N						
	S				●	✳✳	
	H			○			
ISO	a _p	f	CA1000	CM1000	CN1000 CS1000	CW1400 CW1800	
RPGX090700T00525	0.1-0.3	0.5-2.5				○ ○	

● Ex stock ○ On demand

- CM Mixed ceramic
- CC Mixed ceramic, coated
- CN Si3N4 Ceramic
- CR Al2O3 cutting ceramic, reinforced

B

Milling

C

Drilling

D

Technical Information

E

Index



- Ideal machining conditions
- ⊗ Normal machining conditions
- ⊗ Unfavourable machining conditions

TPGN	L	I.C	S
11 03	11	6.35	3.18
16 03	16.5	9.525	3.18

Turning ceramic inserts

TP** positive insert				CM	CC	CN	CR
	P	●					
	M						
	K	●			⊗		
	N						
	S					●	⊗ ⊗
	H				○		
ISO	r	a _p	f	CA1000	CM1000	CN1000 CS1000	CW1400 CW1800
	TPGN110304T02020	0.4	0.1-0.3	0.08-0.25		○	
	TPGN160304T01020	0.4	0.1-0.3	0.08-0.25		○	
	TPGN160308T01020	0.8	0.1-0.4	0.1-0.3		○	

● Ex stock ○ On demand

CM Mixed ceramic
 CC Mixed ceramic, coated
 CN Si3N4 Ceramic
 CR Al2O3 cutting ceramic, reinforced

A

Turning

B

Milling

C

Drilling

D

Technical Information

E

Index

System code > A198











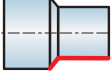

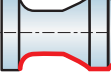
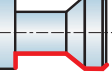



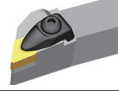





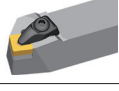





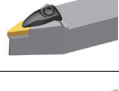







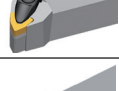





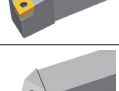









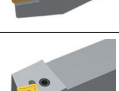

Grade selection > A42

Technical info > A501

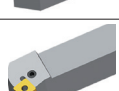
Cutting data > A366



External turning tool holders

Tool holder	Application					Workpiece		Page
	External machining	Facing	Profiling	Profiling	Profiling	Stable	Unstable	
D DCLNR/L 95° 								A230
DDJNR/L 93° 								A231
DSBNR/L 75° 								A232
DTGNR/L 91° 								A233
DVVNN 72.5° 								A234
DVJNR/L 93° 								A235
DWLR/L 95° 								A236
PCBNR/L 75° 								A237
PCLNR/L 95° 								A238
PDJNR/L 93° 								A240
PDNNR/L 63° 								A241
PSBNR/L 75° 								A242
PSDNN 45° 								A244
PSKNR/L 75° 								A245

 Recommended

A

Turning

B

Milling

C

Drilling











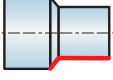

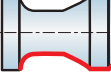
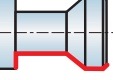

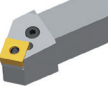

D

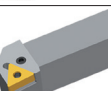
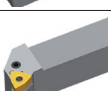
Technical Information

E

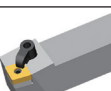
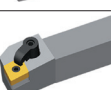
Index

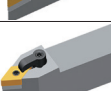
External turning tool holders

Tool holder	Application					Workpiece		Page	
	External machining	Facing	Profiling	Profiling	Profiling	Stable	Unstable		
									
P	PSSNR/L 45° 	<input checked="" type="checkbox"/>	<input checked="" type="checkbox"/>				<input checked="" type="checkbox"/>	<input type="checkbox"/>	A246
	PTFNR/L 91° 		<input checked="" type="checkbox"/>				<input checked="" type="checkbox"/>	<input type="checkbox"/>	A247
	PTTNR/L 60° 	<input checked="" type="checkbox"/>					<input checked="" type="checkbox"/>	<input type="checkbox"/>	A248
	PTGNR/L 90° 	<input checked="" type="checkbox"/>					<input checked="" type="checkbox"/>	<input type="checkbox"/>	A249
	PWLNLR/L 95° 	<input checked="" type="checkbox"/>	<input checked="" type="checkbox"/>				<input checked="" type="checkbox"/>	<input type="checkbox"/>	A251
	PLANR/L 90° 	<input checked="" type="checkbox"/>	<input checked="" type="checkbox"/>			<input checked="" type="checkbox"/>	<input checked="" type="checkbox"/>	<input type="checkbox"/>	A316
	PLFNR/L 90° 	<input checked="" type="checkbox"/>					<input checked="" type="checkbox"/>	<input type="checkbox"/>	A317
	PCLNR/L 95° 	<input checked="" type="checkbox"/>	<input checked="" type="checkbox"/>				<input checked="" type="checkbox"/>	<input type="checkbox"/>	A318
M	MCBNR/L 75° 	<input checked="" type="checkbox"/>					<input checked="" type="checkbox"/>	<input type="checkbox"/>	A252
	MCLNR/L 95° 	<input checked="" type="checkbox"/>	<input checked="" type="checkbox"/>				<input checked="" type="checkbox"/>	<input type="checkbox"/>	A253
	MDJNR/L 93° 			<input checked="" type="checkbox"/>	<input checked="" type="checkbox"/>	<input checked="" type="checkbox"/>	<input checked="" type="checkbox"/>	<input checked="" type="checkbox"/>	A254
	MDPNN 62.5° 					<input checked="" type="checkbox"/>	<input checked="" type="checkbox"/>	<input type="checkbox"/>	A255
	MSBNR/L 75° 	<input checked="" type="checkbox"/>					<input checked="" type="checkbox"/>	<input type="checkbox"/>	A256
	MSRNR/L 75° 	<input checked="" type="checkbox"/>					<input checked="" type="checkbox"/>	<input type="checkbox"/>	A257

 Recommended

A

Turning

B

Milling

C

Drilling













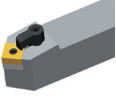

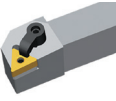

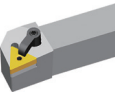

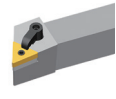













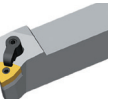



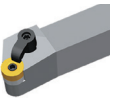



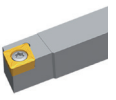

D

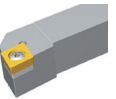
Technical Information

E

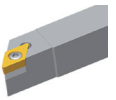



Index

External turning tool holders

Tool holder	Application					Workpiece		Page
	External machining	Facing	Profiling	Profiling	Profiling	Stable	Unstable	
M	MSKNR/L 75° 							A258
	MSDNN 45° 							A259
	MTGNR/L 90° 							A260
	MTJNR/L 93° 							A261
	MTJNR/L-Z 93° 							A262
	MTFNR/L 91° 							A263
	MVVNN 72,5° 							A264
	MVJNR/L 93° 							A265
	MWLNRL 95° 							A266
	MRGNR/L - 							A268
	MRDNN - 							A267
	SCACR/L 90° 							A269
	SCLCR/L 95° 							A270
	SDACR/L 90° 							A271

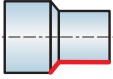
 Recommended

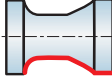
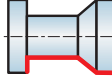
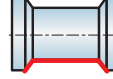
External turning tool holders

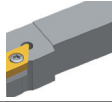
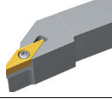
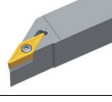
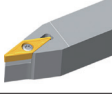
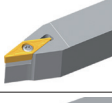
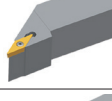
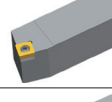
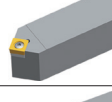
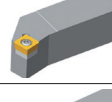
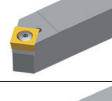
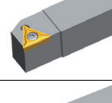
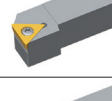
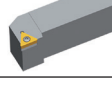
Tool holder	Application					Workpiece		Page
	External machining	Facing	Profiling	Profiling	Profiling	Stable	Unstable	
								
SDJCR/L 93° 	<input checked="" type="checkbox"/>			<input checked="" type="checkbox"/>		<input checked="" type="checkbox"/>	<input checked="" type="checkbox"/>	A272
SDNCN 63° 					<input checked="" type="checkbox"/>	<input checked="" type="checkbox"/>	<input checked="" type="checkbox"/>	A273
SVJBR/L 93° 	<input checked="" type="checkbox"/>			<input checked="" type="checkbox"/>		<input checked="" type="checkbox"/>	<input checked="" type="checkbox"/>	A274
SVABR/L 90° 	<input checked="" type="checkbox"/>			<input checked="" type="checkbox"/>		<input checked="" type="checkbox"/>	<input checked="" type="checkbox"/>	A275
SVVBN 72,5° 					<input checked="" type="checkbox"/>	<input checked="" type="checkbox"/>	<input checked="" type="checkbox"/>	A276
SVVCN 72,5° 					<input checked="" type="checkbox"/>	<input checked="" type="checkbox"/>	<input checked="" type="checkbox"/>	A277
SVJCR/L 93° 	<input checked="" type="checkbox"/>			<input checked="" type="checkbox"/>		<input checked="" type="checkbox"/>	<input checked="" type="checkbox"/>	A278
SSBCR/L 75° 	<input checked="" type="checkbox"/>					<input checked="" type="checkbox"/>		A279
SSDCN 45° 					<input checked="" type="checkbox"/>	<input checked="" type="checkbox"/>		A280
SSKCR/L 75° 		<input checked="" type="checkbox"/>				<input checked="" type="checkbox"/>		A281
SSSCR/L 45° 	<input checked="" type="checkbox"/>					<input checked="" type="checkbox"/>		A282
STACR/L 90° 	<input checked="" type="checkbox"/>					<input checked="" type="checkbox"/>	<input checked="" type="checkbox"/>	A283
STFCR/L 91° 		<input checked="" type="checkbox"/>				<input checked="" type="checkbox"/>		A284
STGCR/L 91° 	<input checked="" type="checkbox"/>					<input checked="" type="checkbox"/>	<input checked="" type="checkbox"/>	A285

 Recommended

A

Turning

B

Milling

C

Drilling

D

Technical Information

E

Index

S

External turning tool holders

Tool holder	Application					Workpiece		Page
	External machining	Facing	Profiling	Profiling	Profiling	Stable	Unstable	
A Turning STTCR/L 60°								A286
B Milling SWACR/L 90°								A287
SRDCN -								A288
SRGCR/L -								A289
S SCACR/L-SC 90°								A306
SCLCR/L-SC 95°								A307
SDACR/L-SC 90°								A308
SDHCR/L-SC 107°30'								A309
SDJCR/L-SC 93°								A310
SDNCN-SC 62°30'								A311
SVACR/L-SC 90°								A312
SVJCR/L-SC 93°								A313
C CKJNR/L 93°								A290
CKNNR/L 63°								A291

Recommended

Notes

Dotted lines for taking notes.

A

Turning

B

Milling

C

Drilling

D

Technical
Information

E

Index

P C L N L 25 25 M 12

1 2 3 4 5 6 7 8 9

A

Turning

B

Milling

C













Drilling





























D



Technical Information

E

Index

Clamping system			Insert shape	
Code	Description			
P	Lever lock clamping		C	
M	Wedge/pin lock clamping		D	
S	Screw-on clamping		R	
C/J	Wedge clamping		S	
D	Duel wedge clamping		T	
			V	
			W	
1			2	





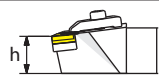

Tool holder type and entering angle					Clearance angle	
					B	C
A	B	C	D	E		
					D	E
F	G	H	J	K		
					N	P
L	M	N	O	P		
						
Q	R	S	T	U		
						
V	W	X				
3					4	

Cutting direction	
	
	
	
5	

Shank height h [mm]	
	
Code	h
12	12
16	16
20	20
25	25
32	32
40	40
50	50
6	

Shank width b [mm]	
	
Code	b
12	12
16	16
20	20
25	25
32	32
40	40
50	50
7	

Holder length L [mm]	
	
Code	L
H	100
K	125
M	150
P	170
Q	180
R	200
S	250
T	300
8	

Cutting edge length l [mm]								
I.C [mm]	Insert shape							
								
	C	D	R	S	T	V	W	
5,56	09							
6,35	06	07					11	
9,525	09	11	09	09	16	16	06	
12,7	12	15	12	12	22	22	08	
15,875	16	19	15	15	27			
19,05	19		19	19	33			
25,4	25		25	25	44			
32	32							
9								

A

Turning

B

Milling

C

Drilling

D

Technical Information

E

Index

A

CN** holder (external) D-Clamping

DCLNR/L Kr: 95°

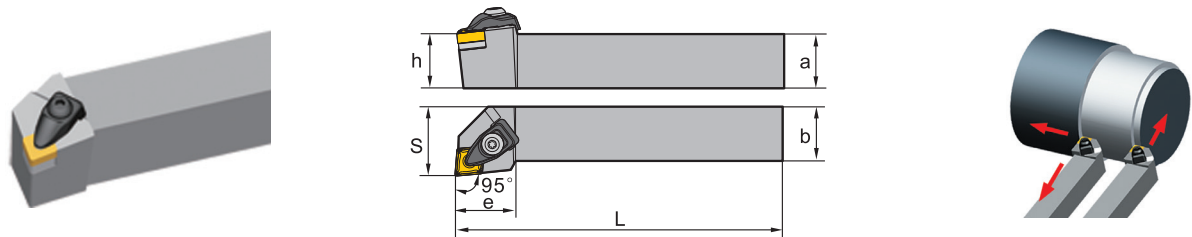

Turning

B







Article	*	Stock		Dimensions [mm]						Inserts
		R	L	a	b	L	h	s	e	
DCLNR/L1616H09	● ○	●	○	16	16	100	16	20	24	CN**0903**
DCLNR/L2020K09	● ●	●	●	20	20	125	20	25	24	CN**0903**
DCLNR/L2525M09	● ●	●	●	25	25	150	25	32	24	CN**0903**
DCLNR/L2020K12	● ●	●	●	20	20	125	20	25	28	CN**1204**
DCLNR/L2525M12	● ●	●	●	25	25	150	25	32	28	CN**1204**
DCLNR/L3225P12	● ●	●	●	32	25	170	32	32	28	CN**1204**

Milling

C







- Ex stock ○ On demand
- * With internal cooling

Drilling

Spare parts			
	Insert	CN**0903**	CN**1204**
	h	16-25	20-32
	Clamp	C1RA	C2RA
	Screw (clamp)	CM5×22C (4.0 Nm)	CM6×25C (7.0 Nm)
	Screw (shim)	SM5×8.65XA1	SM6×10XA1
	Shim	C09BM	C12BM
	Spring	SPR6	SPR4
	Wrench (shim)	WH30L	WH40L
	Wrench (clamp)	WH30L	WH40L

D

Technical Information

Insert					
					
Wiper	Finishing	Medium Cut	Roughing	Cast Iron	PCBN/PCD
A51	A52	A53	A57	A61	A177

E

Index



DN holder (external) D-Clamping**



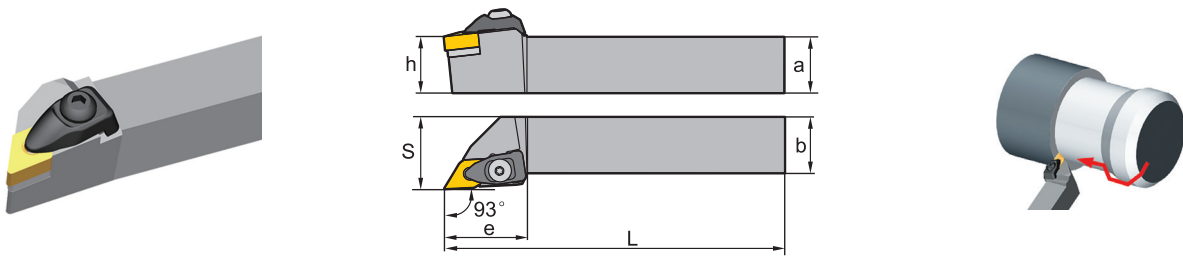



DDJNR/L Kr: 93°









Article	*	Stock		Dimensions [mm]						Inserts
		R	L	a	b	L	h	s	e	
DDJNR/L1616H11	●	●	16	16	100	16	20	30	DN**1104**	
DDJNR/L2020K11	●	●	20	20	125	20	25	30	DN**1104**	
DDJNR/L2525M11	●	●	25	25	150	25	32	30	DN**1104**	
DDJNR/L3225P11	○	○	32	25	170	32	32	30	DN**1104**	
DDJNR/L2020K15	●	●	20	20	125	20	25	35	DN**1506**	
DDJNR/L2525M15	●	●	25	25	150	25	32	35	DN**1506**	
DDJNR/L3232P15	●	●	32	32	170	32	40	35	DN**1506**	

● Ex stock ○ On demand

* With internal cooling

Spare parts			
	Insert	DN**1104**	DN**1506**
		h	h
	Clamp	C1RA	C2RA
	Screw (clamp)	CM5×22C (4.0 Nm)	CM6×25C (7.0 Nm)
	Screw (shim)	SM5×8.65XA1	SM6×10XA1
	Shim	D11BM	D15BM
	Spring	SPR6	SPR4
	Wrench (shim)	WH30L	WH40L
	Wrench (clamp)	WH30L	WH40L

Insert					
					
Wiper	Finishing	Medium Cut	Roughing	Cast Iron	PCBN/PCD
A62	A63	A63	A68	A69	A178

A

Turning

B

Milling

C

Drilling

D

Technical Information

E

Index

SN** holder (external) D-Clamping



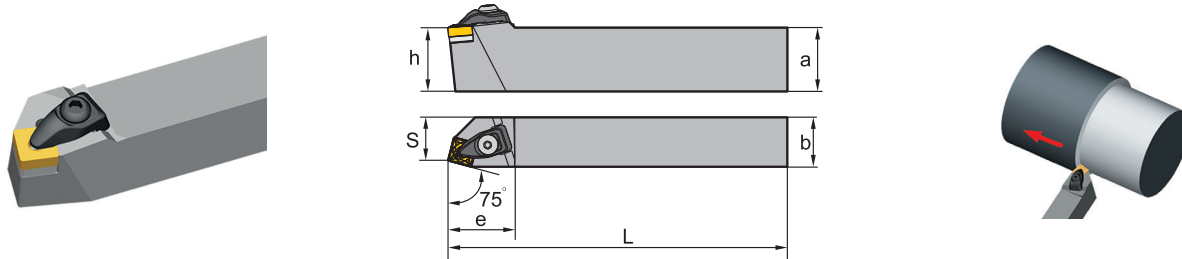



DSBNR/L Kr: 75°







Article	*	Stock		Dimensions [mm]						Inserts
		R	L	a	b	L	h	s	e	
DSBNR/L1616H09	○			16	16	100	16	13	26	SN**0903**
DSBNR/L2020K12	●	●		20	20	125	20	17	34	SN**1204**
DSBNR/L2525M12	●	●		25	25	150	25	22	34	SN**1204**
DSBNR/L3225P12	●	●		32	25	170	32	22	34	SN**1204**
DSBNR/L3232P15	●	●		32	32	170	32	27	41	SN**1506**

● Ex stock ○ On demand

* With internal cooling

Spare parts				
	Insert	SN**0903**	SN**1204**	SN**1506**
	h	16	20-32	32
	Clamp	C1RA	C2RA	C3RA
	Screw (clamp)	CM5×22C (4.0 Nm)	CM6×25C (7.0 Nm)	CM6×25C (7.0 Nm)
	Screw (shim)	SM5×8.65XA1	SM6×10XA1	SM6×10XA2
	Shim	S09BM	S12BM	S15BM
	Spring	SPR6	SPR4	SPR4
	Wrench (shim)	WH30L	WH40L	WH40L
	Wrench (clamp)	WH30L	WH40L	WH40L

Insert				
				
Finishing	Medium Cut	Roughing	Cast Iron	PCBN/PCD
A73	A73	A78	A84	A162

System code > A228

Grade selection > A42

Technical info > A501

Cutting data > A366

TN holder (external) D-Clamping**



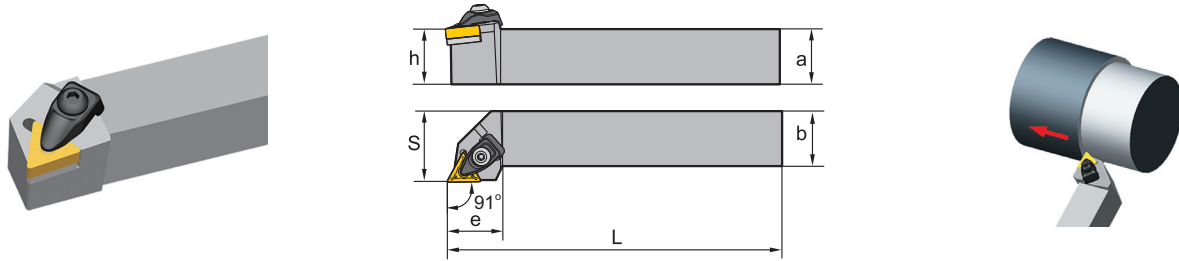



DTGNR/L Kr: 91°









Article	*	Stock		Dimensions [mm]						Inserts
		R	L	a	b	L	h	s	e	
DTGNR/L1616H16	●	●		16	16	100	16	20	25	TN**1604**
DTGNR/L2020K16	●	●		20	20	125	20	25	25	TN**1604**
DTGNR/L2525M16	●	●		25	25	150	25	32	25	TN**1604**

● Ex stock ○ On demand

* With internal cooling

Spare parts		
	Insert h	TN**1604** 16-25
	Clamp	C1RA
	Screw (clamp)	CM5×22C (4.0 Nm)
	Screw (shim)	SM5×8.65XA1
	Shim	T16BM
	Spring	SPR6
	Wrench (shim)	WH30L
	Wrench (clamp)	WH30L

Insert					
					
Wiper A87	Finishing A88	Medium Cut A90	Roughing A92	Cast Iron A99	PCBN/PCD A163

A

Turning

B

Milling

C

Drilling

D

Technical Information

E

Index

A

VN** holder (external) D-Clamping

DVVNN Kr: 72°30'

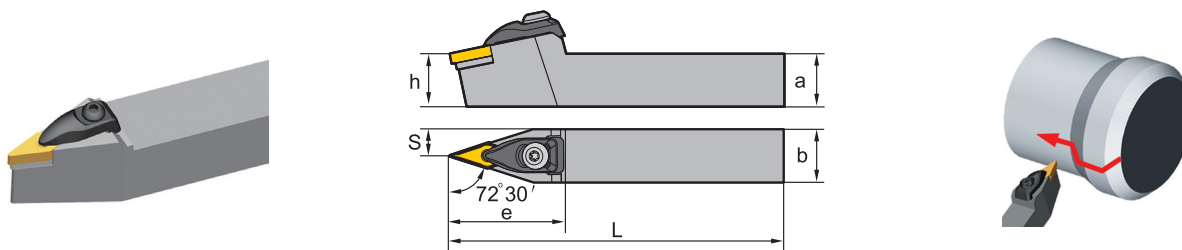

Turning

B

Article	*	Stock	Dimensions [mm]						Inserts
			a	b	L	h	s	e	
DVVNN2020K16	●		20	20	125	20	10	44	VN**1604**
DVVNN2525M16	●		25	25	150	25	12.5	44	VN**1604**

Milling

● Ex stock ○ On demand

* With internal cooling

C

Spare parts		
	Insert	VN**1604**
	h	20-25
	Clamp	C6RA
	Screw (clamp)	CM5×22C (4.0 Nm)
	Screw (shim)	SM5×8.65XA1
	Shim	V16BM
	Spring	SPR6
	Wrench (shim)	WH30L
	Wrench (clamp)	WH30L

Drilling

D

Insert				
Finishing	Medium Cut	Roughing	Cast Iron	PCBN/PCD
A102	A102	A104	A103	A179

Technical Information

E

Index

System code > A228

Grade selection > A42

Technical info > A501

Cutting data > A366

VN holder (external) D-Clamping**

DVJNR/L Kr: 93°

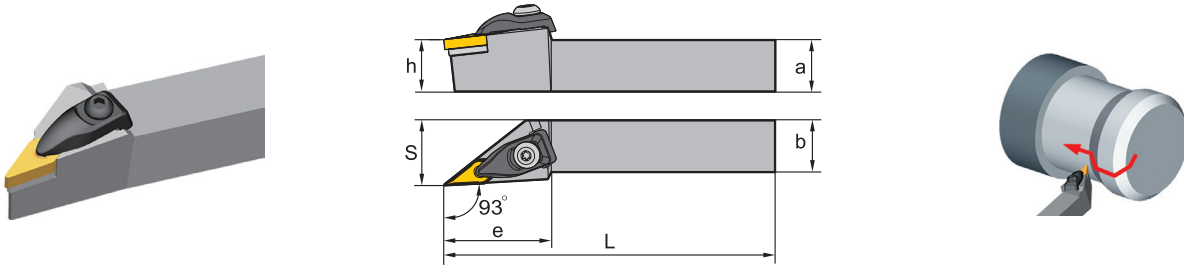







Article	*	Stock		Dimensions [mm]						Inserts
		R	L	a	b	L	h	s	e	
DVJNR/L2020K16	•	•	20	20	125	20	25	41	VN**1604**	
DVJNR/L2525M16	•	•	25	25	150	25	32	41	VN**1604**	

• Ex stock ○ On demand

* With internal cooling

Spare parts

	Insert h	VN**1604** 20-25
	Clamp	C6RA
	Screw (clamp)	CM5×22C (4.0 Nm)
	Screw (shim)	SM5×8.65XA1
	Shim	V16BM
	Spring	SPR6
	Wrench (clamp)	WH30L
	Wrench (shim)	WH30L

Insert

				
Finishing A102	Medium Cut A102	Roughing A104	Cast Iron A103	PCBN/PCD A179

System code > A228

Grade selection > A42

Technical info > A501

Cutting data > A366



A

Turning

B

Milling

C

Drilling

D

Technical Information

E

Index

A

WN** holder (external) D-Clamping

DWLNLR/L Kr: 95°

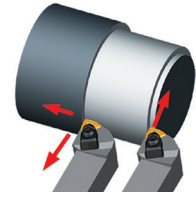
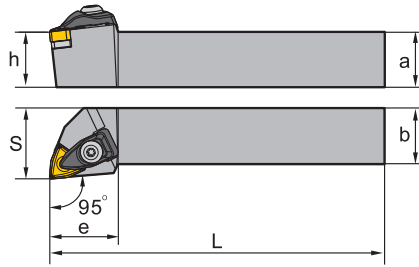
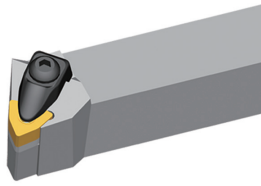

Turning

B

Article	*	Stock		Dimensions [mm]						Inserts
		R	L	a	b	L	h	s	e	
DWLNLR/L1616H06	●	●		16	16	100	16	25	24	WN**0604**
DWLNLR/L2020K06	●	●		20	20	125	20	25	24	WN**0604**
DWLNLR/L2525M06	●	●		25	25	150	25	32	24	WN**0604**
DWLNLR/L2020K08	●	●		20	20	125	20	25	31	WN**0804**
DWLNLR/L2525M08	●	●		25	25	150	25	32	31	WN**0804**
DWLNLR/L3225P08	●	●		32	25	170	32	32	31	WN**0804**

Milling

C

● Ex stock ○ On demand

* With internal cooling

Drilling

Spare parts			
	Insert	WN**0604**	WN**0804**
		h	16-25
	Clamp	C1RA	C2RA
	Screw (clamp)	CM5×22C (4.0 Nm)	CM6×25C (7.0 Nm)
	Screw (shim)	SM5×8.65XA1	SM6×10XA1
	Shim	W06BM	W08BM
	Spring	SPR6	SPR4
	Wrench (shim)	WH30L	WH40L
	Wrench (clamp)	WH30L	WH40L

D

Technical Information

Insert					
Wiper	Finishing	Medium Cut	Roughing	Cast Iron	PCBN/PCD
A106	A107	A107	A109	A111	A165

E

Index

System code > A228

Grade selection > A42

Technical info > A501

Cutting data > A366

CN holder (external)** P-Clamping

PCBNR/L Kr: 75°

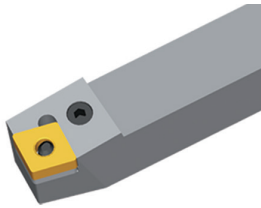



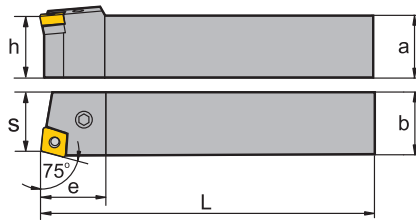



Right hand style









Article	*	Stock		Dimensions [mm]						Inserts
		R	L	a	b	L	h	s	e	
PCBNR/L2020K12	•	•	20	20	125	20	17	27	CN**1204**	
PCBNR/L2525M12	•	•	25	25	150	25	22	27	CN**1204**	
PCBNR/L3232P12	•	•	32	32	170	32	27	27	CN**1204**	
PCBNR/L2525M16	•	•	25	25	150	25	22	33	CN**1606**	
PCBNR/L3232P16	•	•	32	32	170	32	27	33	CN**1606**	
PCBNR/L3232P19	•	•	32	32	170	32	27	38	CN**1906**	
PCBNR/L4040S19	•	•	40	40	250	40	35	38	CN**1906**	
PCBNR/L4040S2507	•	•	40	40	250	40	35	50	CN**2507**	
PCBNR/L4040S2509	•	•	40	40	250	40	35	50	CN**2509**	

• Ex stock ○ On demand

* With internal cooling

Spare parts						
	Insert	CN**1204**	CN**1606**	CN**1906**	CN**2507**	CN**2509**
	h	20-32	25-32	32-40	40	40
	Knee lever	L4	L5	L6	L8	L8
	Screw	LEM8×21 (10.2 Nm)	LEM8×25 (10.2 Nm)	LEM10×27 (16.6 Nm)		
	Screw				LEM12×36A (25.2 Nm)	LEM12×36A (25.2 Nm)
	Shim	C12AP	C16AP	C19AP	C25AP-07	C25AP
	Shim pin (shim)	SP4	SP5	SP6	SP8	SP8
	Wrench	WH30L	WH30L	WH40L	WH50L	WH50L

Insert					
					
Wiper	Finishing	Medium Cut	Roughing	Cast Iron	PCBN/PCD
A51	A52	A53	A57	A61	A177

A

Turning

B

Milling

C

Drilling

D

Technical Information

E

Index

CN** holder (external) P-Clamping

PCLNR/L Kr: 95°

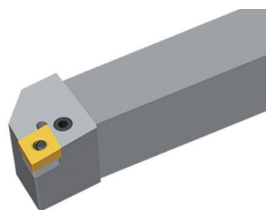

Right hand style

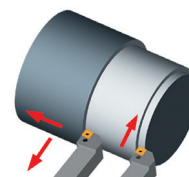
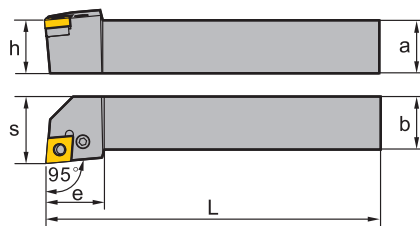

Article	*	Stock		Dimensions [mm]						Inserts
		R	L	a	b	L	h	s	e	
PCLNR/L1616H09	● ●	16	16	100	16	20	20	CN**0903**		
PCLNR/L2020K09	● ●	20	20	125	20	25	22	CN**0903**		
PCLNR/L2525M09	○ ●	25	25	150	25	32	22	CN**0903**		
PCLNR/L1616H12	○ ○	16	16	100	16	20	20	CN**1204**		
PCLNR/L2020K12	● ●	20	20	125	20	25	28	CN**1204**		
PCLNR/L2525M12	● ●	25	25	150	25	32	28	CN**1204**		
PCLNR/L3232P12	● ●	32	32	170	32	40	28	CN**1204**		
PCLNR/L2525M16	● ●	25	25	150	25	32	33	CN**1606**		
PCLNR/L3232P16	● ●	32	32	170	32	40	33	CN**1606**		
PCLNR/L3232P19	● ●	32	32	170	32	40	38	CN**1906**		
PCLNR/L4040S19	● ●	40	40	250	40	50	38	CN**1906**		
PCLNR/L4040S2507	● ●	40	40	250	40	50	49	CN**2507**		
PCLNR/L4040S2509	● ●	40	40	250	40	50	49	CN**2509**		







● Ex stock ○ On demand

* With internal cooling

Spare parts

	Insert	CN**0903**	CN**1204**	CN**1606**	CN**1906**	CN**2507**	CN**2509**
	h	16-25	16-32	25-32	32-40	40	40
	Knee lever	L3	L4	L5	L6	L8	L8
	Screw		LEM8×21 (10.2 Nm)	LEM8×25 (10.2 Nm)	LEM10×27 (16.6 Nm)		
	Screw	LEM6×13.4A (7.0 Nm)				LEM12×36A (25.2 Nm)	LEM12×36A (25.2 Nm)
	Shim	C09AP	C12AP	C16AP	C19AP	C25AP-07	C25AP
	Shim pin (shim)	SP10	SP4	SP5	SP6	SP8	SP8
	Wrench	WH25L	WH30L	WH30L	WH40L	WH50L	WH50L

CN holder (external)**

Insert					
					
Wiper	Finishing	Medium Cut	Roughing	Cast Iron	PCBN/PCD
A51	A52	A53	A57	A61	A177

A

Turning

B

Milling

C

Drilling

D

Technical Information

E

Index

System code > A228

Grade selection > A42

Technical info > A501

Cutting data > A366

DN** holder (external) P-Clamping

PDJNR/L Kr: 93°

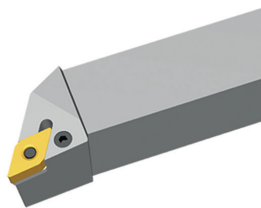

Right hand style

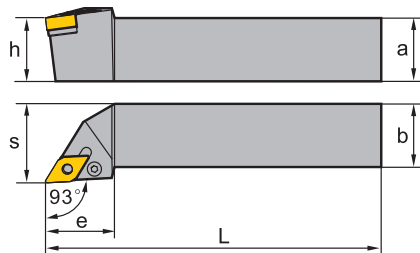

Article	*	Stock		Dimensions [mm]						Inserts
		R	L	a	b	L	h	s	e	
PDJNR/L1616H11	●	●		16	16	100	16	20	25	DN**1104**
PDJNR/L2020K11	●	●		20	20	125	20	25	25	DN**1104**
PDJNR/L2525M11	●	●		25	25	150	25	32	30	DN**1104**
PDJNR/L2020K15-3	●	○		20	20	125	20	25	35	DN**1504**
PDJNR/L2525M15-3	●	●		25	25	150	25	32	35	DN**1504**
PDJNR/L3232P15-3	●	●		32	32	170	32	40	35	DN**1504**
PDJNR/L2020K15	●	○		20	20	125	20	25	35	DN**1506**
PDJNR/L2525M15	●	●		25	25	150	25	32	35	DN**1506**
PDJNR/L3232P15	●	●		32	32	170	32	40	35	DN**1506**

● Ex stock ○ On demand

* With internal cooling

Spare parts				
	Insert	DN**1104**	DN**1504**	DN**1506**
	h	16-32	20-32	20-32
	Knee lever	L3	L4	L4B
	Screw		LEM8×21 (10.2 Nm)	LEM8×21 (10.2 Nm)
	Screw	LEM6×13.4A (7.0 Nm)		
	Shim	D11AP	D15AP	D15AP
	Shim pin (shim)	SP3	SP4	SP4
	Wrench	WH25L	WH30L	WH30L

Insert					
Wiper	Finishing	Medium Cut	Roughing	Cast Iron	PCBN/PCD
A62	A63	A63	A68	A69	A178

System code > A228

Grade selection > A42

Technical info > A501

Cutting data > A366

DN holder (external)** P-Clamping

PDNNR/L Kr: 63°

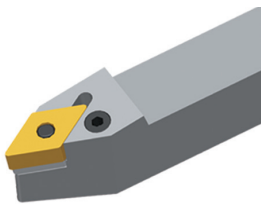



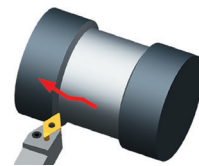
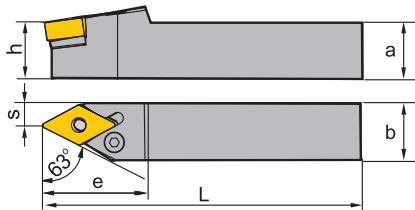

Left hand style









Article	*	Stock		Dimensions [mm]						Inserts
		R	L	a	b	L	h	s	e	
PDNNR/L2020K15-3	● ○	20	20	125	20	8	37	DN**1504**		
PDNNR/L2525M15-3	● ○	25	25	150	25	12.5	37	DN**1504**		
PDNNR/L3232P15-3	● ●	32	32	170	32	16	37	DN**1504**		
PDNNR/L2020K15	● ●	20	20	125	20	8	37	DN**1506**		
PDNNR/L2525M15	● ●	25	25	150	25	12.5	37	DN**1506**		
PDNNR/L3232P15	● ●	32	32	170	32	16	37	DN**1506**		

● Ex stock ○ On demand

* With internal cooling

Spare parts			
	Insert hh	DN**1504**	DN**1506**
		20-32	20-32
	Knee lever	L4	L4B
	Screw	LEM8×21 (10.2 Nm)	LEM8×21 (10.2 Nm)
	Shim	D15AP	D15AP
	Shim pin (shim)	SP4	SP4
	Wrench	WH30L	WH30L

Insert					
					
Wiper A62	Finishing A63	Medium Cut A63	Roughing A68	Cast Iron A69	PCBN/PCD A178

A

Turning

B

Milling

C

Drilling

D

Technical Information

E

Index

SN** holder (external) P-Clamping

PSBNR/L Kr: 75°

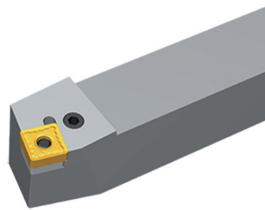

Right hand style

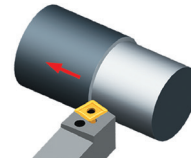
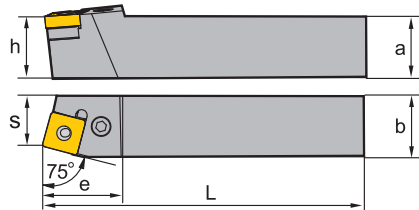

Article	*	Stock		Dimensions [mm]						Inserts
		R	L	a	b	L	h	s	e	
PSBNR/L1616H09	● ○	●	○	16	16	100	16	13	21	SN**0903**
PSBNR/L2020K09	● ○	●	○	20	20	125	20	17	23	SN**0903**
PSBNR/L2020K12	● ●	●	●	20	20	125	20	17	28	SN**1204**
PSBNR/L2525M12	● ●	●	●	25	25	125	25	22	28	SN**1204**
PSBNR/L3225P12	● ○	●	○	32	25	170	32	22	28	SN**1204**
PSBNR/L3232P12	● ○	●	○	32	32	170	32	27	28	SN**1204**
PSBNR/L2525M15	● ○	●	○	25	25	150	25	22	35	SN**1506**
PSBNR/L3232P15	● ●	●	●	32	32	170	32	27	35	SN**1506**
PSBNR/L3232P19	● ●	●	●	32	32	170	32	27	40	SN**1906**
PSBNR/L4040S19	● ●	●	●	40	40	250	40	35	40	SN**1906**
PSBNR/L4040S2507	○ ○	○	○	40	40	250	40	35	48	SN**2507**
PSBNR/L4040S2509	○ ○	○	○	40	40	250	40	35	48	SN**2509**





● Ex stock ○ On demand

* With internal cooling

Spare parts

	Insert	SN**0903**	SN**1204**	SN**1506**	SN**1906**	SN**2507**	SN**2509**
		h	16-20	20-32	25-32	32-40	40
	Knee lever	L3	L4	L5	L6	L8	L8
	Screw		LEM8×21 (10.2 Nm)	LEM8×25 (10.2 Nm)	LEM10×27 (16.6 Nm)		
	Screw	LEM6×13.4A (7.0 Nm)				LEM12×36A (25.2 Nm)	LEM12×36A (25.2 Nm)
	Shim	S09AP	S12AP	S15AP	S19AP	S25AP	
	Shim						S25AP-09
	Shim pin (shim)	SP10	SP4	SP5	SP6	SP8	SP8
	Wrench	WH25L	WH30L	WH30L	WH40L	WH50L	WH50L

SN holder (external)**

Insert				
				
Finishing	Medium Cut	Roughing	Cast Iron	PCBN/PCD
A73	A73	A78	A84	A162

A

Turning

B

Milling

C

Drilling

D

Technical Information

E

Index

System code > A228

Grade selection > A42

Technical info > A501

Cutting data > A366

SN** holder (external) P-Clamping

PSDNN Kr: 45°

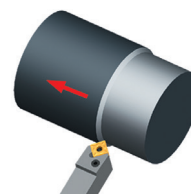
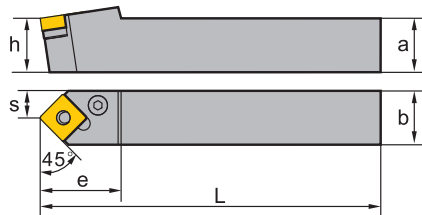
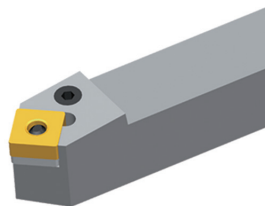

Article	*	Stock	Dimensions [mm]						Inserts
			a	b	L	h	s	e	
PSDNN1212F09	○	○	12	12	80	12	6	21	SN**0903**
PSDNN1616H09	●	●	16	16	100	16	8	23	SN**0903**
PSDNN2020K12	●	●	20	20	125	20	10	30	SN**1204**
PSDNN2525M12	●	●	20	20	150	20	12.5	30	SN**1204**
PSDNN3232P12	●	●	32	32	170	32	16	40	SN**1204**
PSDNN2525M15	●	●	25	25	150	25	12.5	40	SN**1506**
PSDNN3232P15	●	●	32	32	170	32	16	40	SN**1506**
PSDNN3232P19	●	●	32	32	170	32	16	40	SN**1906**
PSDNN4040S19	●	●	40	40	250	40	20	40	SN**1906**

● Ex stock ○ On demand

* With internal cooling

Spare parts						
	Insert	SN**0903**	SN**0903**	SN**1204**	SN**1506**	SN**1906**
	h	12	16	20-32	25-32	32-40
	Knee lever	L3B	L3	L3	L5	L6
	Screw	LEM5×12B (4.0 Nm)				
	Screw				LEM8×25 (10.2 Nm)	LEM10×27 (16.6 Nm)
	Screw		LEM6×13.4A (7.0 Nm)	LEM6×13.4A (7.0 Nm)		
	Shim		S09AP	S12AP	S15AP	S19AP
	Shim pin (shim)		SP10	SP10	SP5	SP6
	Wrench		WH25L	WH25L	WH30L	WH40L
	Wrench	WT09IP				

Insert				
Finishing	Medium Cut	Roughing	Cast Iron	PCBN/PCD
A73	A73	A78	A84	A162

System code > A228

Grade selection > A42

Technical info > A501

Cutting data > A366

SN holder (external) P-Clamping**

PSKNR/L Kr: 75°

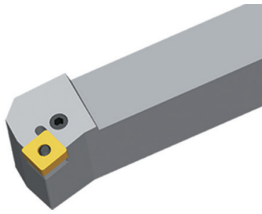



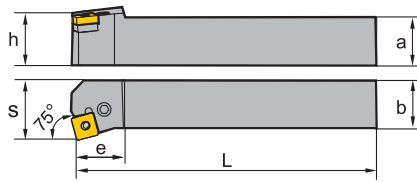



Right hand style







Article	*	Stock		Dimensions [mm]						Inserts
		R	L	a	b	L	h	s	e	
PSKNR/L1616H09		○	○	16	16	100	16	20	17	SN**0903**
PSKNR/L2020K09		●	○	20	20	125	20	25	20	SN**0903**
PSKNR/L2020K12		●	●	20	20	125	20	25	26	SN**1204**
PSKNR/L2525M12		●	●	25	25	150	25	32	26	SN**1204**
PSKNR/L3232P12		●	●	32	32	170	32	40	26	SN**1204**
PSKNR/L2525M15		●	○	25	25	150	25	32	32	SN**1506**
PSKNR/L3232P15		●	●	32	32	170	32	40	32	SN**1506**
PSKNR/L3232P19		●	●	32	32	170	32	40	36	SN**1906**
PSKNR/L4040S19		○	○	40	40	250	40	50	40	SN**1906**

● Ex stock ○ On demand

* With internal cooling

Spare parts		SN**0903**	SN**1204**	SN**1506**	SN**1906**
		16-20	20-32	25-32	32-40
	Knee lever	L3	L4	L5	L6
	Screw		LEM8×21 (10.2 Nm)	LEM8×25 (10.2 Nm)	LEM10×27 (16.6 Nm)
	Screw	LEM6×13.4A (7.0 Nm)			
	Shim	S09AP	S12AP	S15AP	S19AP
	Shim pin (shim)	SP10	SP4	SP5	SP6
	Wrench	WH25L	WH30L	WH30L	WH40L

Insert				
				
Finishing	Medium Cut	Roughing	Cast Iron	PCBN/PCD
A73	A73	A78	A84	A162

SN** holder (external) P-Clamping

PSSNR/L Kr: 45°

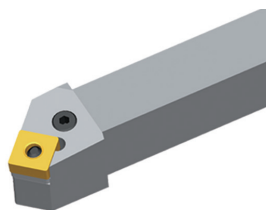

Right hand style

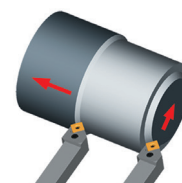
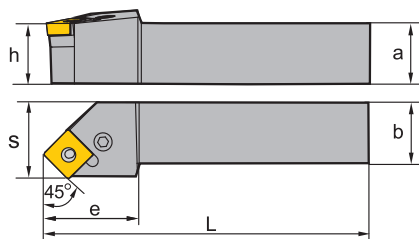

Article	*	Stock		Dimensions [mm]						Inserts
		R	L	a	b	L	h	s	e	
PSSNR/L1616H09	●	●		16	16	100	16	20	25	SN**0903**
PSSNR/L2020K12	●	●		20	20	125	20	25	30	SN**1204**
PSSNR/L2525M12	●	●		25	25	150	25	32	30	SN**1204**
PSSNR/L3232P12	●	●		32	32	170	32	40	40	SN**1204**
PSSNR/L2525M15	●	●		25	25	150	25	32	30	SN**1506**
PSSNR/L3232P15	●	●		32	32	170	32	40	40	SN**1506**
PSSNR/L3232P19	●	●		32	32	170	32	40	40	SN**1906**
PSSNR/L4040S19	●	●		40	40	250	40	50	50	SN**1906**
PSSNR/L4040S2507	●	●		40	40	250	40	50	50	SN**2507**
PSSNR/L4040S2509	●	●		40	40	250	40	50	50	SN**2509**

● Ex stock ○ On demand

* With internal cooling

Spare parts							
	Insert	SN**0903**	SN**1204**	SN**1506**	SN**1906**	SN**2507**	SN**2509**
	h	16	20-32	25-32	32-40	40	40
	Knee lever	L3	L4	L5	L6	L8	L8
	Screw		LEM8×21 (10.2 Nm)	LEM8×25 (10.2 Nm)	LEM10×27 (16.6 Nm)		
	Screw	LEM6×13.4A (7.0 Nm)				LEM12×36A (25.2 Nm)	LEM12×36A (25.2 Nm)
	Shim	S09AP	S12AP	S15AP	S19AP	S25AP	
	Shim						S25AP-09
	Shim pin (shim)	SP10	SP4	SP5	SP6	SP8	SP8
	Wrench	WH25L	WH30L	WH30L	WH40L	WH50L	WH50L

Insert				
Finishing	Medium Cut	Roughing	Cast Iron	PCBN/PCD
A73	A73	A78	A84	A162

System code > A228

Grade selection > A42

Technical info > A501

Cutting data > A366

TN holder (external)** P-Clamping

PTFNR/L Kr: 91°

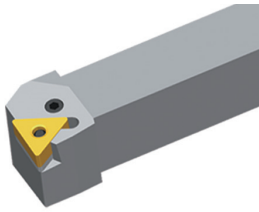

Right hand style

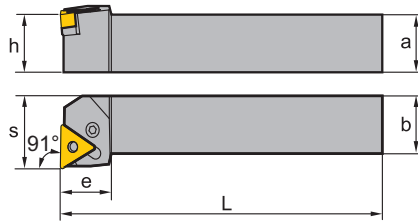

Article	*	Stock		Dimensions [mm]						Inserts
		R	L	a	b	L	h	s	e	
PTFNR/L1616H16	●	●	16	16	100	16	20	20	TN**1604**	
PTFNR/L2020K16	●	●	20	20	125	20	25	20	TN**1604**	
PTFNR/L2525M16	●	●	25	25	150	25	32	20	TN**1604**	
PTFNR/L2525M22	●	●	25	25	150	25	32	25	TN**2204**	
PTFNR/L3232P22	●	●	32	32	170	32	40	25	TN**2204**	
PTFNR/L3232P27	●	○	32	32	170	32	40	34	TN**2706**	
PTFNR/L4040S27	○	○	40	40	250	40	50	34	TN**2706**	

● Ex stock ○ On demand

* With internal cooling

Spare parts				
	Insert	TN**1604**	TN**2204**	TN**2706**
	h	16-25	25-32	32-40
	Knee lever	L3	L4	L5
	Screw		LEM8×21 (10.2 Nm)	LEM8×25 (10.2 Nm)
	Screw	LEM6×13.4A (7.0 Nm)		
	Shim	T16AP	T22AP	T27AP
	Shim pin (shim)	SP3	SP4	SP5
	Wrench	WH25L	WH30L	WH30L

Insert						
Wiper	Finishing	Medium Cut	Roughing	Heavy Turning	Cast Iron	PCBN/PCD
A87	A88	A90	A92	A97	A99	A163

A

Turning

B

Milling

C

Drilling

D

Technical Information

E

Index

TN** holder (external) P-Clamping

PTTNR/L Kr: 60°

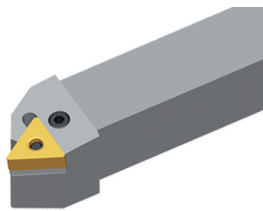

Right hand style

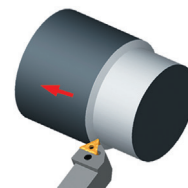
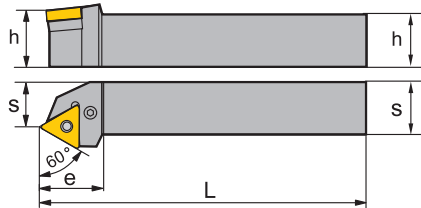

Article	*	Stock		Dimensions [mm]						Inserts
		R	L	a	b	L	h	s	e	
PTTNR/L1616H16	●			16	16	100	16	13	25	TN**1604**
PTTNR/L2020K16	●	○		20	20	125	20	17	25	TN**1604**
PTTNR/L2525M22	●	●		25	25	150	20	22	32	TN**2204**

● Ex stock ○ On demand

* With internal cooling

Spare parts

	Insert	TN**1604**	TN**2204**
	h	16-25	20
	Knee lever	L3	L4
	Screw		LEM8×21 (10.2 Nm)
	Screw	LEM6×13.4A (7.0 Nm)	
	Shim	T16AP	T22AP
	Shim pin (shim)	SP3	SP4
	Wrench	WH25L	WH30L

Insert

Wiper A87	Finishing A88	Medium Cut A90	Roughing A92	Heavy Turning A97	Cast Iron A99	PCBN/PCD A163

System code > A228

Grade selection > A42

Technical info > A501

Cutting data > A366

TN** holder (external) P-Clamping

PTGNR/L Kr: 90°

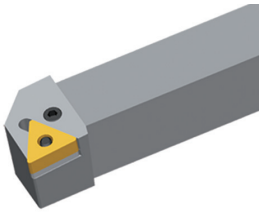

Right hand style

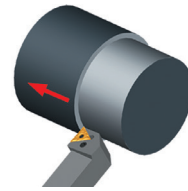
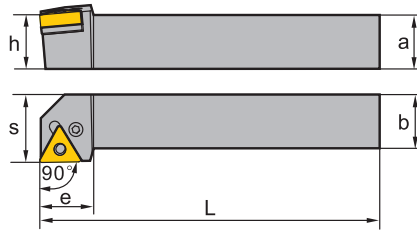









Article	*	Stock		Dimensions [mm]						Inserts
		R	L	a	b	L	h	s	e	
PTGNR/L1010E11	●			10	10	70	10	14	16	TN**1103**
PTGNR/L1212F11	●	●		12	12	80	12	16	14	TN**1103**
PTGNR/L1616H11	●			16	16	100	16	20	18	TN**1103**
PTGNR/L2020K11	●	○		20	20	125	20	25	19	TN**1103**
PTGNR/L2525M11	○	○		25	25	150	25	32	20	TN**1103**
PTGNR/L1616H16	●	●		16	16	100	16	20	20	TN**1604**
PTGNR/L2020K16	●	●		20	20	125	20	25	20	TN**1604**
PTGNR/L2525M16	●	●		25	25	150	25	32	20	TN**1604**
PTGNR/L3232P16	●	○		32	32	170	32	40	20	TN**1604**
PTGNR/L2525M22	●	●		25	25	150	25	32	28	TN**2204**
PTGNR/L3232P22	●	●		32	32	170	32	40	28	TN**2204**
PTGNR/L3232P27	●	○		32	32	170	32	40	33	TN**2706**
PTGNR/L4040S27	○	○		40	40	250	40	50	33	TN**2706**

● Ex stock ○ On demand

* With internal cooling







Spare parts

	Insert h	TN**1103**	TN**1604**	TN**2204**	TN**2706**
		10-25	16-32	25-32	32-40
	Knee lever	L2	L3	L4	L5
	Screw	LEM5×9B (4.0 Nm)			
	Screw			LEM8×21 (10.2 Nm)	LEM8×25 (10.2 Nm)
	Screw		LEM6×13.4A (7.0 Nm)		
	Shim		T16AP	T22AP	T27AP
	Shim pin (shim)		SP3	SP4	SP5
	Wrench		WH25L	WH30L	WH30L
	Wrench	WT09IP			

A

Turning

TN** holder (external)

Insert						
						
Wiper	Finishing	Medium Cut	Roughing	Heavy Turning	Cast Iron	PCBN/PCD
A87	A88	A90	A92	A97	A99	A163

B

Milling

C

Drilling

D

Technical Information

E

Index

System code > A228

Grade selection > A42

Technical info > A501

Cutting data > A366

WN holder (external)** **P-Clamping**

PWLNLR/L Kr: 95°

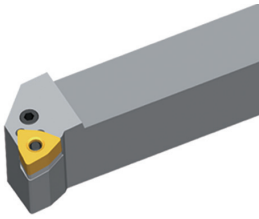

Right hand style

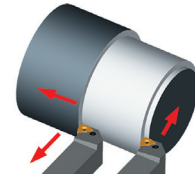
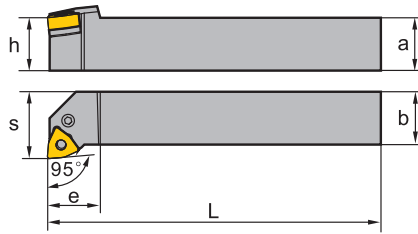

Article	*	Stock		Dimensions [mm]						Inserts
		R	L	a	b	L	h	s	e	
PWLNLR/L1616H06	●	●	16	16	100	16	20	20	20	WN**0604**
PWLNLR/L2020K06	●	●	20	20	125	20	25	20	20	WN**0604**
PWLNLR/L2525M06	●	●	25	25	150	25	32	20	20	WN**0604**
PWLNLR/L2020K08	●	●	20	20	125	20	25	26	26	WN**0804**
PWLNLR/L2525M08	●	●	25	25	150	25	32	26	26	WN**0804**

● Ex stock ○ On demand

* With internal cooling

Spare parts

	Insert h	WN**0604**	WN**0804**
		16-25	20-25
Knee lever		L3	L4
Screw			LEM8x21 (10.2 Nm)
Screw		LEM6x13.4A (7.0 Nm)	
Shim		W06AP	W08AP
Shim pin (shim)		SP3	SP4
Wrench		WH25L	WH30L

Insert

Wiper A106	Finishing A107	Medium Cut A107	Roughing A109	Cast Iron A111	PCBN/PCD A165

CN** holder (external) M-Clamping

MCBNR/L Kr: 75°

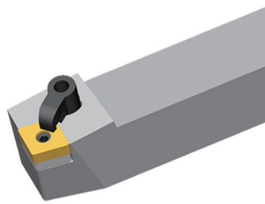

Right hand style

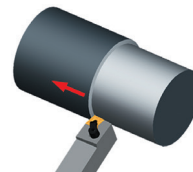
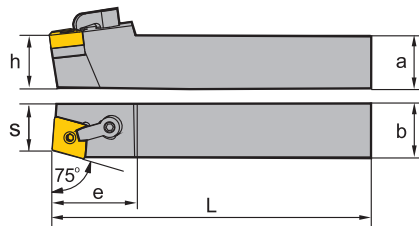

Article	*	Stock		Dimensions [mm]						Inserts
		R	L	a	b	L	h	s	e	
MCBNR/L2020K12	● ○	●	○	20	20	125	20	17	32	CN**1204**
MCBNR/L2525M12	● ●	●	●	25	25	150	20	22	32	CN**1204**
MCBNR/L3225P12	● ●	●	●	32	25	170	32	22	32	CN**1204**
MCBNR/L2525M16	○ ○	○	○	25	25	150	25	22	40	CN**1606**
MCBNR/L3232P16	● ●	●	●	32	32	170	32	27	40	CN**1606**
MCBNR/L3232P19	○ ○	○	○	32	32	170	32	27	45	CN**1906**
MCBNR/L4040R19	○ ●	○	●	40	40	200	40	35	45	CN**1906**

● Ex stock ○ On demand

* With internal cooling

Spare parts

	Insert	CN**1204**		CN**1606**		CN**1906**	
		h	20	25-32	25-32	32-40	
	Clamp		C1RD	C1RD	C2RD	C5RD	
	Dowel pin		TM6×17	TM6×17	TM8×21	TM10×21	
	Screw (clamp)		DM6×25 (7.0 Nm)	DM6×30 (7.0 Nm)	DM6×30 (7.0 Nm)		
	Screw (clamp)					DM8×30X (10.2 Nm)	
	Shim		C12BM	C12BM	C16BM	C19BM	
	Wrench (dowel pin)		WH30L	WH30L	WH30L	WH40L	
	Wrench (clamp)		WH30L	WH30L	WH30L	WH40L	

Insert

Wiper	Finishing	Medium Cut	Roughing	Cast Iron	PCBN/PCD
A51	A52	A53	A57	A61	A177

System code > A228

Grade selection > A42

Technical info > A501

Cutting data > A366

CN holder (external)** **M-Clamping**

MCLNR/L Kr: 95°

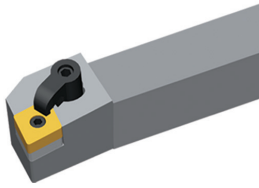



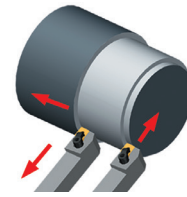
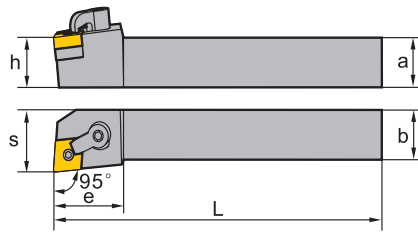





Right hand style









Article	*	Stock		Dimensions [mm]						Inserts
		R	L	a	b	L	h	s	e	
MCLNR/L2020K12	●	●	20	20	125	20	25	32	CN**1204**	
MCLNR/L2525M12	●	●	25	25	150	25	32	32	CN**1204**	
MCLNR/L3225P12	●	●	32	25	170	32	32	32	CN**1204**	
MCLNR/L2525M16	●	●	25	25	150	25	32	38	CN**1606**	
MCLNR/L3232P16	●	●	32	32	170	32	40	38	CN**1606**	
MCLNR/L3232P19	●	●	32	32	170	32	40	45	CN**1906**	
MCLNR/L4040R19	●	○	40	40	200	40	50	45	CN**1906**	
MCLNR/L4040S25	○	○	40	40	250	40	50	38	CN**2509**	

● Ex stock ○ On demand

* With internal cooling

Spare parts						
	Insert	CN**1204**	CN**1204**	CN**1606**	CN**1906**	CN**2509**
	h	20	25-32	25-32	32-40	40
	Clamp	C1RD	C1RD	C2RD	C5RD	C6RD
	Dowel pin	TM6×17	TM6×17	TM8×21	TM10×21	TM12×29 (25.2 Nm)
	Screw (clamp)	DM6×25 (7.0 Nm)	DM6×30 (7.0 Nm)	DM6×30 (7.0 Nm)		
	Screw (clamp)				DM8×30X (10.2 Nm)	DM10×35X (16.6 Nm)
	Shim	C12BM	C12BM	C16BM	C19BM	
	Shim					C25BM-09
	Wrench (clamp)	WH30L	WH30L	WH30L	WH40L	WH50L
	Wrench (dowel pin)	WH30L	WH30L	WH30L	WH40L	WH40L

Insert					
					
Wiper	Finishing	Medium Cut	Roughing	Cast Iron	PCBN/PCD
A51	A52	A53	A57	A61	A177

A

Turning

B

Milling

C

Drilling

D

Technical Information

E

Index

DN** holder (external) M-Clamping

MDJNR/L Kr: 93°

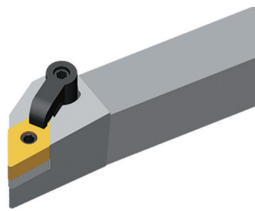

Right hand style

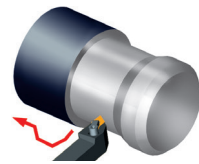
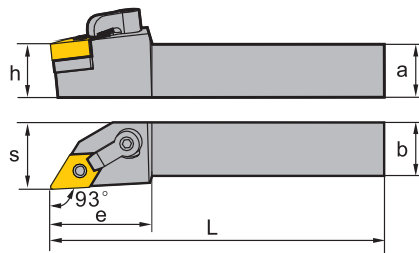

Article	*	Stock		Dimensions [mm]						Inserts
		R	L	a	b	L	h	s	e	
MDJNR/L2020K11	●	●		20	20	125	20	25	32	DN**1104**
MDJNR/L2525M11	●	●		25	25	150	25	32	32	DN**1104**
MDJNR/L3225P11	●	○		32	25	170	32	32	32	DN**1104**
MDJNR/L2020K15	●	●		20	20	125	20	25	38	DN**1506**
MDJNR/L2525M15	●	●		25	25	150	25	32	38	DN**1506**
MDJNR/L3225P15	●	●		32	25	170	32	32	38	DN**1506**

● Ex stock ○ On demand

* With internal cooling

Spare parts

	Insert h	DN**1104**	DN**1104**	DN**1506**	DN**1506**
		20	25-32	20	25-32
Clamp		C1RD	C1RD	C2RD	C2RD
Dowel pin		TM5×13	TM5×13	TM6×19	TM6×19
Screw (clamp)		DM6×25 (7.0 Nm)	DM6×30 (7.0 Nm)	DM6×25 (7.0 Nm)	DM6×30 (7.0 Nm)
Shim		D11BM	D11BM	D15BM	D15BM
Wrench (clamp)		WH30L	WH30L	WH30L	WH30L
Wrench (dowel pin)		WH20L	WH20L	WH30L	WH30L

Insert

Wiper A62	Finishing A63	Medium Cut A63	Roughing A68	Cast Iron A69	PCBN/PCD A178

System code > A228

Grade selection > A42

Technical info > A501

Cutting data > A366

DN holder (external) M-Clamping**

MDPNN Kr: 62°30'

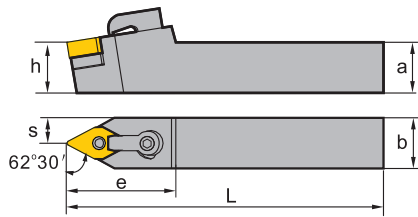
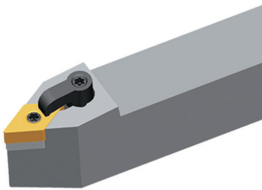

Article	*	Stock	Dimensions [mm]						Inserts
			a	b	L	h	s	e	
MDPNN2020K11	●		20	20	125	20	10	35	DN**1104**
MDPNN2525M11	●		25	25	150	25	12.5	35	DN**1104**
MDPNN2020K15	●		20	20	125	20	10	40	DN**1506**
MDPNN2525M15	●		25	25	150	25	12.5	40	DN**1506**
MDPNN3225P15	●		32	25	170	32	12.5	40	DN**1506**

● Ex stock ○ On demand

* With internal cooling

Spare parts		DN**1104**	DN**1104**	DN**1506**	DN**1506**
Insert		20	25-32	20	25-32
h		20	25-32	20	25-32
	Clamp	C1RD	C1RD	C2RD	C2RD
	Dowel pin	TM5×13	TM5×13	TM6×19	TM6×19
	Screw (clamp)	DM6×25 (7.0 Nm)	DM6×30 (7.0 Nm)	DM6×25 (7.0 Nm)	DM6×30 (7.0 Nm)
	Shim	D11BM	D11BM	D15BM	D15BM
	Wrench (clamp)	WH30L	WH30L	WH30L	WH30L
	Wrench (dowel pin)	WH20L	WH20L	WH30L	WH30L

Insert					
Wiper	Finishing	Medium Cut	Roughing	Cast Iron	PCBN/PCD
A62	A63	A63	A68	A69	A178

System code > A228

Grade selection > A42

Technical info > A501

Cutting data > A366



A

Turning

B

Milling

C

Drilling

D

Technical Information

E

Index

SN** holder (external) M-Clamping

MSBNR/L Kr: 75°

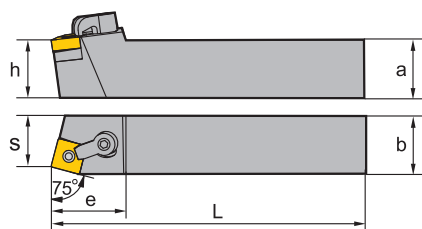
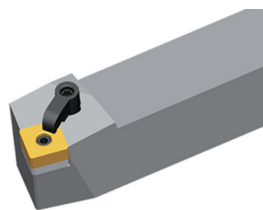

Right hand style

Article	*	Stock		Dimensions [mm]						Inserts
		R	L	a	b	L	h	s	e	
MSBNR/L2020K12	●	●		20	20	125	20	17	32	SN**1204**
MSBNR/L2525M12	●	○		25	25	150	25	22	32	SN**1204**
MSBNR/L3225P12		●		32	25	170	32	22	32	SN**1204**
MSBNR/L2525M15	●	○		25	25	150	25	22	38	SN**1506**
MSBNR/L3232P15	●	●		32	32	170	32	29	38	SN**1506**
MSBNR/L4032R15	○			40	32	200	40	27	38	SN**1506**
MSBNR/L3232P19	●	●		32	32	170	32	27	45	SN**1906**
MSBNR/L4040R19	○	●		40	40	200	40	35	45	SN**1906**
MSBNR/L4040R25	●	○		40	40	200	40	35	50	SN**2507**
MSBNR/L4040S2509	○	○		40	40	250	40	35	50	SN**2509**

● Ex stock ○ On demand

* With internal cooling

Spare parts

	Insert	SN**1204**	SN**1204**	SN**1506**	SN**1906**	SN**2507**	SN**2509**
	h	20	25-32	25-40	32-40	40	40
	Clamp	C1RD	C1RD	C2RD	C5RD	C6RD	C6RD
	Dowel pin	TM6×17	TM6×17	TM8×21	TM10×21	TM12×29	TM12×29
	Screw (clamp)	DM6×25 (7.0 Nm)	DM6×30 (7.0 Nm)	DM6×30 (7.0 Nm)			
	Screw (clamp)				DM8×30X (10.2 Nm)	DM10×35X (16.6 Nm)	DM10×35X (16.6 Nm)
	Shim	S12BM	S12BM	S15BM	S19BM	S25BM	S25BM
	Wrench (clamp)	WH30L	WH30L	WH30L	WH40L	WH40L	WH40L
	Wrench (dowel pin)	WH31L	WH31L	WH30L	WH40L	WH50L	WH50L

Insert

Finishing	Medium Cut	Roughing	Cast Iron	PCBN/PCD
A73	A73	A78	A84	A162

System code > A228

Grade selection > A42

Technical info > A501

Cutting data > A366

SN holder (external)** **M-Clamping**

MSRNR/L Kr: 75°

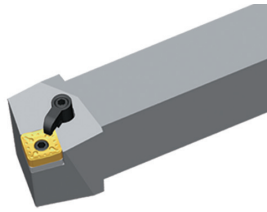

Right hand style

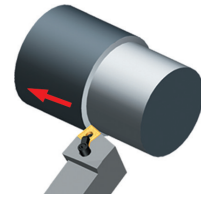
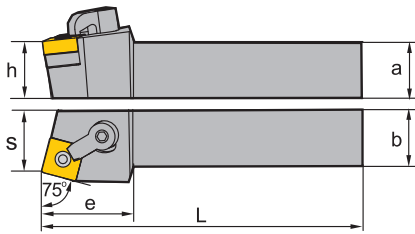

Article	*	Stock		Dimensions [mm]						Inserts
		R	L	a	b	L	h	s	e	
MSRNR/L2020K12	●	●		20	20	125	20	22	36	SN**1204**
MSRNR/L2525M12	●	●		25	25	150	25	27	36	SN**1204**
MSRNR/L3225P12		○		32	25	170	32	27	36	SN**1204**
MSRNR/L2525M15	●	○		25	25	150	25	27	40	SN**1506**
MSRNR/L3232P15	●	●		32	32	170	32	35	40	SN**1506**
MSRNR/L4032R15		○		40	32	200	40	35	40	SN**1506**
MSRNR/L3232P19		○	○	32	32	170	32	35	45	SN**1906**
MSRNR/L4040R19		○		40	40	200	40	43	45	SN**1906**
MSRNR/L4040R2509		○	○	40	40	200	40	43	50	SN**2509**
MSRNR/L4040S2509		○	○	40	40	250	40	43	50	SN**2509**

● Ex stock ○ On demand

* With internal cooling

Spare parts		SN**1204**	SN**1204**	SN**1506**	SN**1906**	SN**2509**
Insert	h	20	25-32	25-40	32-40	40
	Clamp	C1RD	C1RD	C2RD	C5RD	C6RD
	Dowel pin	TM6×17	TM6×17	TM8×21	TM10×21	TM12×29
	Screw (clamp)	DM6×25 (7.0 Nm)	DM6×30 (7.0 Nm)	DM6×30 (7.0 Nm)		
	Screw (clamp)				DM8×30X (10.2 Nm)	DM10×35X (16.6 Nm)
	Shim	S12BM	S12BM	S15BM	S19BM	S25BM
	Wrench (clamp)	WH30L	WH30L	WH30L	WH40L	WH40L
	Wrench (dowel pin)	WH31L	WH31L	WH30L	WH40L	WH50L

Insert				
Finishing	Medium Cut	Roughing	Cast Iron	PCBN/PCD
A73	A73	A78	A84	A162

A

Turning

B

Milling

C

Drilling

D

Technical Information

E

Index

SN** holder (external) M-Clamping

MSKNR/L Kr: 75°

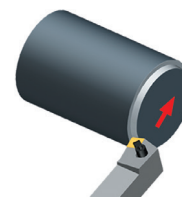
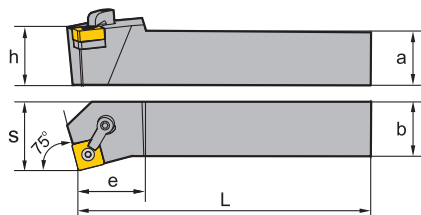
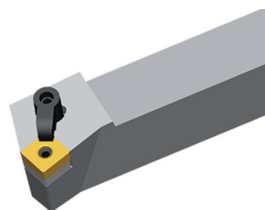

Right hand style

Article	*	Stock		Dimensions [mm]						Inserts
		R	L	a	b	L	h	s	e	
MSKNR/L2020K12	●	●		20	20	125	20	25	32	SN**1204**
MSKNR/L2525M12	●	●		25	25	150	25	32	32	SN**1204**
MSKNR/L3225P12	●	○		32	25	170	32	32	32	SN**1204**
MSKNR/L2525M15	●	○		25	25	150	25	32	28	SN**1506**
MSKNR/L3232P15	●	○		32	32	170	32	40	38	SN**1506**
MSKNR/L4032R15		○		40	32	200	40	40	38	SN**1506**
MSKNR/L3232P19	●	●		32	32	170	32	40	45	SN**1906**
MSKNR/L4040R19		○		40	40	200	40	50	45	SN**1906**
MSKNR/L4040S2509		○	●	40	40	250	40	50	50	SN**2509**

● Ex stock ○ On demand

* With internal cooling

Spare parts

	Insert	SN**1204**	SN**1204**	SN**1506**	SN**1906**	SN**2509**
	h	20	25-32	25-40	32-40	40
	Clamp	C1RD	C1RD	C2RD	C5RD	C6RD
	Dowel pin	TM6×17	TM6×17	TM8×21	TM10×21	TM12×29
	Screw (clamp)	DM6×25 (7.0 Nm)	DM6×30 (7.0 Nm)	DM6×30 (7.0 Nm)		
	Screw (clamp)				DM8×30X (10.2 Nm)	DM10×35X (16.6 Nm)
	Shim	S12BM	S12BM	S15BM	S19BM	S25BM
	Wrench (clamp)	WH30L	WH30L	WH30L	WH40L	WH40L
	Wrench (dowel pin)	WH30L	WH30L	WH30L	WH40L	WH50L

Insert

Finishing	Medium Cut	Roughing	Cast Iron	PCBN/PCD
A73	A73	A78	A84	A162

System code > A228

Grade selection > A42

Technical info > A501

Cutting data > A366

SN** holder (external) **M-Clamping**

MSDNN Kr: 45°

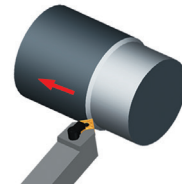
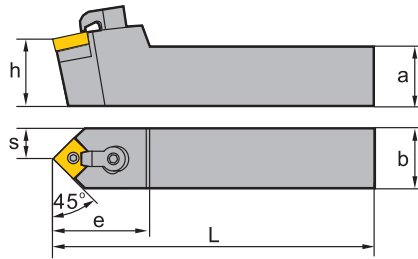
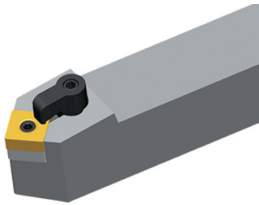

Article	*	Stock	Dimensions [mm]						Inserts
			a	b	L	h	s	e	
MSDNN2020K12	●	●	20	20	125	20	10	35	SN**1204**
MSDNN2525M12	●	●	25	25	150	25	12.5	35	SN**1204**
MSDNN3225P12	●	●	32	25	170	32	12.5	35	SN**1204**
MSDNN2525M15	●	●	25	25	150	25	12.5	42	SN**1506**
MSDNN3232P15	○	○	32	32	170	32	16	42	SN**1506**
MSDNN4032R15	○	○	40	32	200	40	16	42	SN**1506**

● Ex stock ○ On demand

* With internal cooling

Spare parts				
	Insert	SN**1204**	SN**1204**	SN**1506**
	h	20	25-32	25-40
	Clamp	C1RD	C1RD	C2RD
	Dowel pin	TM6×17	TM6×17	TM8×21
	Screw (clamp)	DM6×25 (7.0 Nm)	DM6×30 (7.0 Nm)	DM6×30 (7.0 Nm)
	Shim	S12BM	S12BM	S15BM
	Wrench (clamp)	WH30L	WH30L	WH30L
	Wrench (dowel pin)	WH30L	WH30L	WH30L

Insert				
Finishing	Medium Cut	Roughing	Cast Iron	PCBN/PCD
A73	A73	A78	A84	A162

A

Turning

B

Milling

C

Drilling

D

Technical Information

E

Index

TN** holder (external) M-Clamping

MTGNR/L Kr: 90°

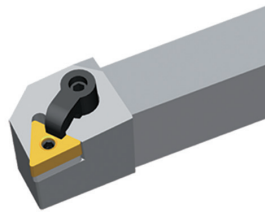

Right hand style

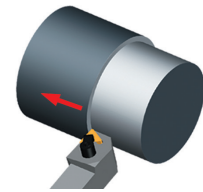
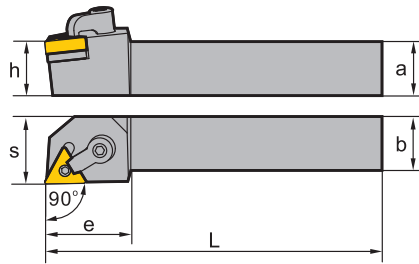

Article	*	Stock		Dimensions [mm]						Inserts
		R	L	a	b	L	h	s	e	
MTGNR/L2020K16	● ○	20	20	125	20	25	33	TN**1604**		
MTGNR/L2525M16	● ●	25	25	150	25	32	33	TN**1604**		
MTGNR/L3225P16	● ○	32	25	170	32	32	33	TN**1604**		
MTGNR/L2525M22	● ○	25	25	150	25	32	35	TN**2204**		
MTGNR/L3225P22	○ ○	32	25	170	32	32	35	TN**2204**		

● Ex stock ○ On demand

* With internal cooling

Spare parts

	Insert h	TN**1604** 20	TN**1604** 25-32	TN**2204** 25-32
Clamp		C1RD	C1RD	C2RD
Dowel pin		TM5×13	TM5×13	TM6×17
Screw (clamp)		DM6×25 (7.0 Nm)	DM6×30 (7.0 Nm)	DM6×30 (7.0 Nm)
Shim		T16BM	T16BM	T22BM
Wrench (clamp)		WH30L	WH30L	WH30L
Wrench (dowel pin)		WH20L	WH20L	WH30L

Insert

Wiper A87	Finishing A88	Medium Cut A90	Roughing A92	Heavy Turning A97	Cast Iron A99	PCBN/PCD A163

System code > A228

Grade selection > A42

Technical info > A501

Cutting data > A366

TN holder (external)** **M-Clamping**

MTJNR/L Kr: 93°

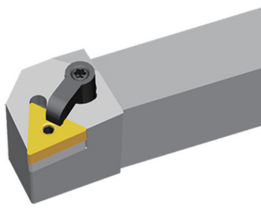

Right hand style

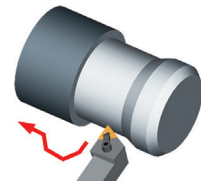
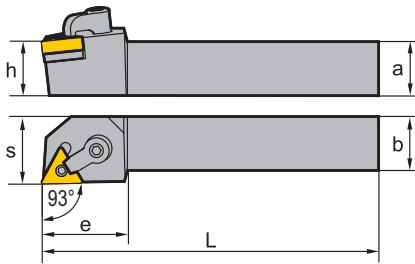

Article	*	Stock		Dimensions [mm]						Inserts
		R	L	a	b	L	h	s	e	
MTJNR/L2020K16	●			20	20	125	20	25	32	TN**1604**
MTJNR/L2525M16	○	○		25	25	150	25	32	32	TN**1604**
MTJNR/L3225P16	○			32	25	170	32	32	32	TN**1604**
MTJNR/L2525M22	○			25	25	150	25	32	36	TN**2204**
MTJNR/L3225P22	○	●		32	25	170	32	32	36	TN**2204**

● Ex stock ○ On demand

* With internal cooling

Spare parts

	Insert h	TN**1604** 20	TN**1604** 25-32	TN**2204** 25-32
Clamp		C1RD	C1RD	C2RD
Dowel pin		TM5×13	TM5×13	TM6×17
Screw (clamp)		DM6×25 (7.0 Nm)	DM6×30 (7.0 Nm)	DM6×30 (7.0 Nm)
Shim		T16BM	T16BM	T22BM
Wrench (clamp)		WH30L	WH30L	WH30L
Wrench (dowel pin)		WH20L	WH20L	WH30L

Insert

Wiper A87	Finishing A88	Medium Cut A90	Roughing A92	Heavy Turning A97	Cast Iron A99	PCBN/PCD A163

System code > A228

Grade selection > A42

Technical info > A501

Cutting data > A366



A

Turning

B

Milling

C

Drilling

D

Technical Information

E

Index

TN** holder (external) M-Clamping

MTJNR/L-Z Kr: 93°

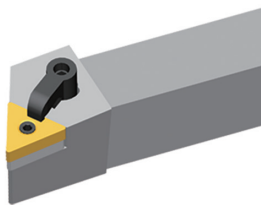

Right hand style

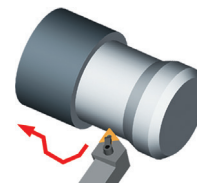
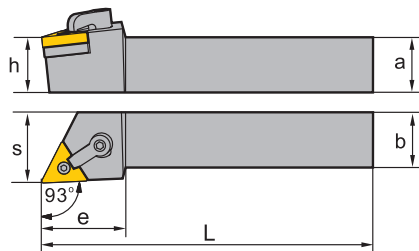

Article	*	Stock		Dimensions [mm]						Inserts
		R	L	a	b	L	h	s	e	
MTJNR/L2020K16-Z	●	●		20	20	125	20	25	32	TN**1604**
MTJNR/L2525M16-Z	●	●		25	25	150	25	32	32	TN**1604**
MTJNR/L3225P16-Z	●	○		32	25	170	32	32	32	TN**1604**
MTJNR/L2525M22-Z	●	●		25	25	150	25	32	36	TN**2204**
MTJNR/L3225P22-Z	●	○		32	25	170	32	32	36	TN**2204**

● Ex stock ○ On demand

* With internal cooling

Spare parts		TN**1604**	TN**1604**	TN**2204**
Insert h		20	25-32	25-32
	Clamp	C1RD	C1RD	C2RD
	Dowel pin	TM5×13	TM5×13	TM6×17
	Screw (clamp)	DM6×25 (7.0 Nm)	DM6×30 (7.0 Nm)	DM6×30 (7.0 Nm)
	Shim	T16BM	T16BM	T22BM
	Wrench (clamp)	WH30L	WH30L	WH30L
	Wrench (dowel pin)	WH20L	WH20L	WH30L

Insert						
Wiper	Finishing	Medium Cut	Roughing	Heavy Turning	Cast Iron	PCBN/PCD
A87	A88	A90	A92	A97	A99	A163

System code > A228

Grade selection > A42

Technical info > A501

Cutting data > A366

TN holder (external)** **M-Clamping**

MTFNR/L Kr: 91°

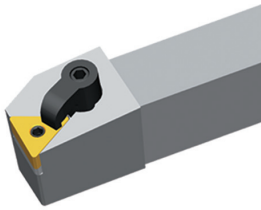

Right hand style

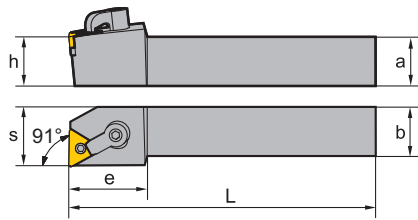

Article	*	Stock		Dimensions [mm]						Inserts
		R	L	a	b	L	h	s	e	
MTFNR/L2020K16	● ○	20	20	125	20	25	32	TN**1604**		
MTFNR/L2525M16	● ●	25	25	150	25	32	32	TN**1604**		
MTFNR/L3225P16	● ○	32	25	170	32	32	32	TN**1604**		
MTFNR/L2525M22	● ○	25	25	150	25	32	36	TN**2204**		
MTFNR/L3225P22	● ○	32	25	170	32	32	36	TN**2204**		

● Ex stock ○ On demand

* With internal cooling

Spare parts

	Insert h	TN**1604** 20	TN**1604** 25-32	TN**2204** 25-32
Clamp		C1RD	C1RD	C2RD
Dowel pin		TM5×13	TM5×13	TM6×17
Screw (clamp)		DM6×25 (7.0 Nm)	DM6×30 (7.0 Nm)	DM6×30 (7.0 Nm)
Shim		T16BM	T16BM	T22BM
Wrench (clamp)		WH30L	WH30L	WH30L
Wrench (dowel pin)		WH20L	WH20L	WH30L

Insert

Wiper A87	Finishing A88	Medium Cut A90	Roughing A92	Heavy Turning A97	Cast Iron A99	PCBN/PCD A163

A

VN** holder (external) M-Clamping

MVVNN Kr: 72°30'

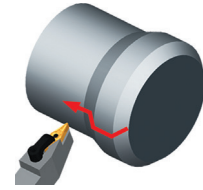
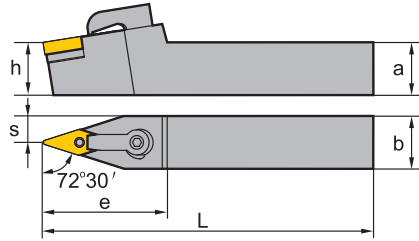
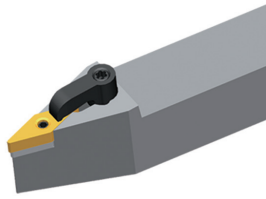

Turning

B

Article	*	Stock	Dimensions [mm]						Inserts
			a	b	L	h	s	e	
MVVNN2020K16	●	●	20	20	125	20	10	45	VN**1604**
MVVNN2525M16	●	●	25	25	150	25	12.5	45	VN**1604**
MVVNN3225P16	○	○	32	25	170	32	12.5	45	VN**1604**
MVVNN3232P16	●	●	32	32	170	32	16	45	VN**1604**

● Ex stock ○ On demand

* With internal cooling

Milling

C

Spare parts			
	Insert	VN**1604**	VN**1604**
	h	20	25-32
	Clamp	C3RD	C3RD
	Dowel pin	TM5×13	TM5×13
	Screw (clamp)	DM6×25 (7.0 Nm)	DM6×30 (7.0 Nm)
	Shim	V16BM	V16BM
	Wrench (clamp)	WH30L	WH30L
	Wrench (dowel pin)	WH20L	WH20L

Drilling

D

Insert				
Finishing	Medium Cut	Roughing	Cast Iron	PCBN/PCD
A102	A102	A104	A103	A179

Technical Information

E

Index

System code > A228

Grade selection > A42

Technical info > A501

Cutting data > A366

VN** holder (external) M-Clamping

MVJNR/L Kr: 93°

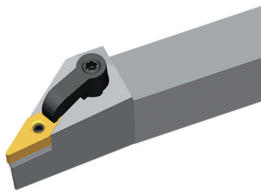

Right hand style

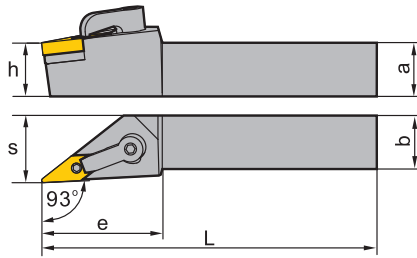

Article	*	Stock		Dimensions [mm]						Inserts
		R	L	a	b	L	h	s	e	
MVJNR/L2020K16	●	●	20	20	125	20	25	45	VN**1604**	
MVJNR/L2525M16	●	●	25	25	150	25	32	45	VN**1604**	
MVJNR/L3225P16	●	●	32	25	170	32	32	45	VN**1604**	
MVJNR/L3232P16	●	●	32	32	170	32	40	45	VN**1604**	

● Ex stock ○ On demand

* With internal cooling

Spare parts

	Insert	VN**1604**	
		h	20
	Clamp	C3RD	C3RD
	Dowel pin	TM5×13	TM5×13
	Screw (clamp)	DM6×25 (7.0 Nm)	DM6×30 (7.0 Nm)
	Shim	V16BM	V16BM
	Wrench (clamp)	WH30L	WH30L
	Wrench (dowel pin)	WH20L	WH20L

Insert

Finishing A102	Medium Cut A102	Roughing A104	Cast Iron A103	PCBN/PCD A179

System code > A228

Grade selection > A42

Technical info > A501

Cutting data > A366

WN** holder (external) M-Clamping

MWLNLR/L Kr: 95°

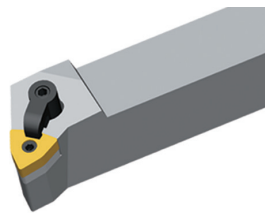

Right hand style

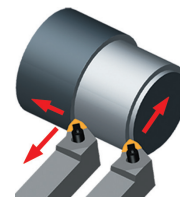
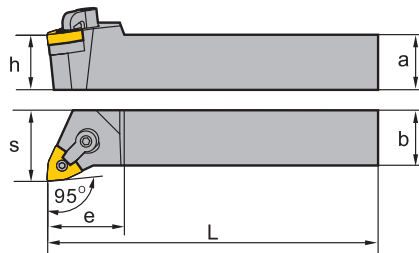

Article	*	Stock		Dimensions [mm]						Inserts
		R	L	a	b	L	h	s	e	
MWLNLR/L2020K06	●	●		20	20	125	20	25	30	WN**0604**
MWLNLR/L2525M06	●	●		25	25	150	25	32	30	WN**0604**
MWLNLR/L2020K08	●	●		20	20	125	20	25	30	WN**0804**
MWLNLR/L2525M08	●	●		25	25	150	25	32	35	WN**0804**
	○			25	25	170	25	32	35	WN**0804**
MWLNLR/L3232P08	●	●		32	32	170	32	40	35	WN**0804**

● Ex stock ○ On demand

* With internal cooling

Spare parts

	Insert h	WN**0604**	WN**0604**	WN**0804**	WN**0804**
		20	25	20	25-32
Clamp		C1RD	C1RD	C1RD	C1RD
Dowel pin		TM5×13	TM5×13	TM6×17	TM6×17
Screw (clamp)		DM6×25 (7.0 Nm)	DM6×30 (7.0 Nm)	DM6×25 (7.0 Nm)	DM6×30 (7.0 Nm)
Shim		W06BM	W06BM	W08BM	W08BM
Wrench (clamp)		WH30L	WH30L	WH30L	WH30L
Wrench (dowel pin)		WH20L	WH20L	WH30L	WH30L

Insert

Wiper A106	Finishing A107	Medium Cut A107	Roughing A109	Cast Iron A111	PCBN/PCD A165

System code > A228

Grade selection > A42

Technical info > A501

Cutting data > A366

RN holder (external)** **M-Clamping**

MRDNN

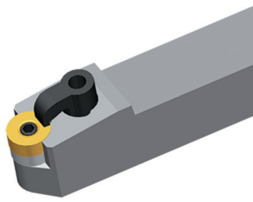

Right hand style

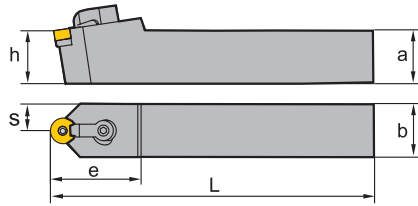

Article	*	Stock	Dimensions [mm]						Inserts
			a	b	L	h	s	e	
MRDNN2020K12		○	20	20	125	20	10	35	RN**1204**
MRDNN2525M12		○	25	25	150	25	12.5	35	RN**1204**
MRDNN3225P12		○	32	25	170	32	12.5	35	RN**1204**
MRDNN3232P12		○	32	32	170	32	16	35	RN**1204**

● Ex stock ○ On demand

* With internal cooling

Spare parts			
	Insert	RN**1204**	RN**1204**
	h	20	25-32
	Clamp	C1RD	C1RD
	Dowel pin	TM6x17	TM6x17
	Screw (clamp)	DM6x25 (7.0 Nm)	DM6x30 (7.0 Nm)
	Shim	R12BM	R12BM
	Wrench (clamp)	WH30L	WH30L
	Wrench (dowel pin)	WH30L	WH30L

Insert
Cast Iron
A112

System code > A228

Grade selection > A42

Technical info > A501

Cutting data > A366



A

Turning

B

Milling

C

Drilling

D

Technical Information

E

Index

RN** holder (external) M-Clamping

MRGNR/L

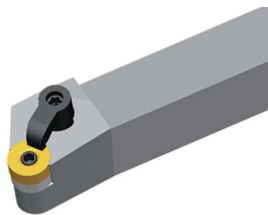

Right hand style

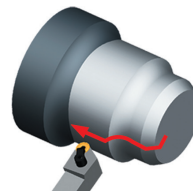
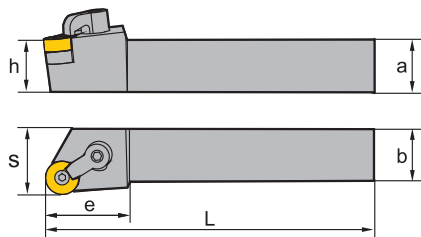





Article	*	Stock		Dimensions [mm]						Inserts
		R	L	a	b	L	h	s	e	
MRGNR/L2020K12		○	○	20	20	125	20	25	32	RN**1204**
MRGNR/L2525M12		○	●	25	25	150	25	32	32	RN**1204**
MRGNR/L3225P12		○	○	32	25	170	32	32	32	RN**1204**
MRGNR/L3232P12		○	○	32	32	170	32	40	32	RN**1204**

● Ex stock ○ On demand

* With internal cooling

Spare parts

	Insert	RN**1204**	RN**1204**
	h	20	25-32
	Clamp	C1RD	C1RD
	Dowel pin	TM6×17	TM6×17
	Screw (clamp)	DM6×25 (7.0 Nm)	DM6×30 (7.0 Nm)
	Shim	R12BM	R12BM
	Wrench (clamp)	WH30L	WH30L
	Wrench (dowel pin)	WH30L	WH30L

Insert



Cast Iron

A112

System code > A228

Grade selection > A42

Technical info > A501

Cutting data > A366

CC holder (external)** S-Clamping

SCACR/L Kr: 90°

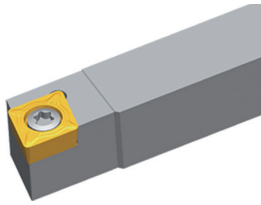

Right hand style

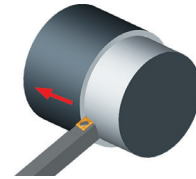
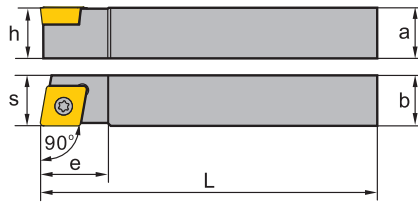



Article	*	Stock		Dimensions [mm]						Inserts
		R	L	a	b	L	h	s	e	
SCACR/L1010E06	•	•		10	10	70	10	10.5	10	CC**0602**
SCACR/L1212F09	•	•		12	12	80	12	12.7	16	CC**09T3**







● Ex stock ○ On demand

* With internal cooling

Spare parts

	Insert	CC**0602**	CC**09T3**
	h	10	12
	Screw	I60M2.5x6.5 (1.0 Nm)	I60M3.5x8 (2.7 Nm)
	Wrench (screw)	WT07IP	WT15IP

Insert

					
Finishing	Medium Cut	Roughing	Alum Machining	Cast Iron	PCBN/PCD
A116	A119	A121	A122	A121	A180

System code > A228

Grade selection > A42

Technical info > A501

Cutting data > A366



A

Turning

B

Milling

C

Drilling

D

Technical Information

E

Index

CC** holder (external) S-Clamping

SCLCR/L Kr: 95°

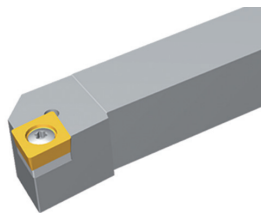

Right hand style

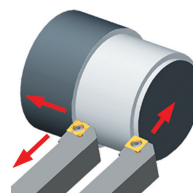
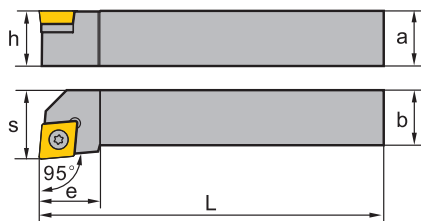

Article	*	Stock		Dimensions [mm]							Inserts
		R	L	a	b	L	h	s	L ₂	e	
SCLCR/L0808D06	●	●	8	8	60	8	10	10	10	CC**0602**	
SCLCR/L1010E06	●	●	10	10	70	10	12	10	10	CC**0602**	
SCLCR/L1212F09	●	●	12	12	80	12	16	16	16	CC**09T3**	
SCLCR/L1616H09	●	●	16	16	100	16	20	16	16	CC**09T3**	
SCLCR/L2020K09	●	●	20	20	125	20	25	25	25	CC**09T3**	
SCLCR/L1616H12	●	●	16	16	100	16	20	18	18	CC**1204**	
SCLCR/L2020K12	●	●	20	20	125	20	25	25	25	CC**1204**	
SCLCR/L2525M12	●	●	25	25	150	25	32	26	26	CC**1204**	
SCLCR/L3225P12	○	○	32	25	170	32	32	26	26	CC**1204**	
SCLCR/L3232P12	●	●	32	32	170	32	40	28	28	CC**1204**	

● Ex stock ○ On demand

* With internal cooling

Spare parts

	Insert	CC**0602**	CC**09T3**	CC**1204**
		h 8-10	12-20	16-32
	Screw	I60M2.5×6.5 (1.0 Nm)	I60M3.5×8 (2.7 Nm)	
	Screw			I60M4×11X (3.4 Nm)
	Screw (shim)			SM6×10XA
	Shim			C12BS
	Wrench (screw)	WT07IP	WT15IP	WT15IP
	Wrench (shim)			WH40L

Insert

Finishing	Medium Cut	Roughing	Alum Machining	Cast Iron	PCBN/PCD
A116	A119	A121	A122	A121	A180

System code > A228

Grade selection > A42

Technical info > A501

Cutting data > A366

DC holder (external) S-Clamping**

SDACR/L Kr: 90°

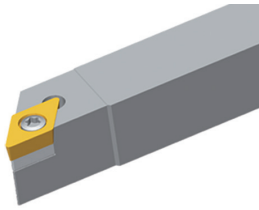

Right hand style

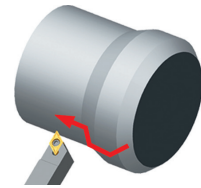
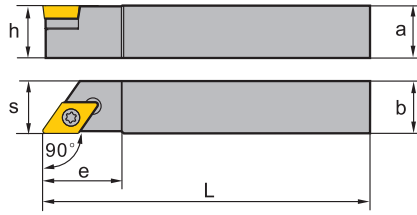

Article	*	Stock		Dimensions [mm]						Inserts
		R	L	a	b	L	h	s	e	
SDACR/L1010E07	•	•	10	10	70	10	10.5	15	DC**0702**	
SDACR/L1212F11	•	•	12	12	80	12	12.5	15	DC**11T3**	
SDACR/L1616H11	•	•	16	16	100	16	16.7	24	DC**11T3**	

• Ex stock ○ On demand

* With internal cooling

Spare parts		DC**0702**	DC**11T3**	DC**11T3**
Insert	h	10	12	16
Screw		I60M2.5x6.5 (1.0 Nm)	I60M3.5x8 (2.7 Nm)	I60M3.5x12 (2.7 Nm)
Screw (shim)				SM5x8.65XA
Shim				D11BS
Wrench (screw)		WT07IP	WT15IP	WT15IP
Wrench (shim)				WH35L

Insert					
Finishing	Medium Cut	Roughing	Alum Machining	Cast Iron	PCBN/PCD
A126	A127	A129	A129	A129	A184

DC** holder (external) S-Clamping

SDJCR/L Kr: 93°

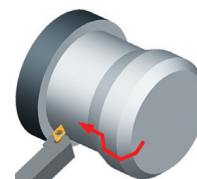
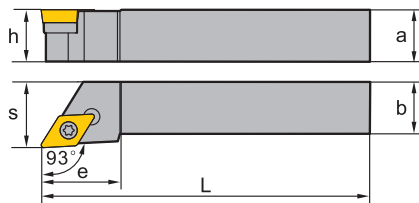
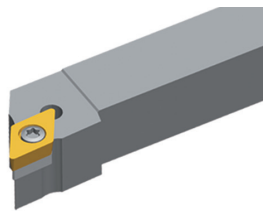





Right hand style

Article	*	Stock		Dimensions [mm]						Inserts
		R	L	a	b	L	h	s	e	
SDJCR/L1010E07	•	•		10	10	70	10	12	15	DC**0702**
SDJCR/L1212F07	•	•		12	12	80	12	16	15	DC**0702**
SDJCR/L1616H07	•	•		16	16	100	16	20	18	DC**0702**
SDJCR/L1616H11	•	•		16	16	100	16	20	24	DC**11T3**
SDJCR/L2020K11	•	•		20	20	125	20	25	24	DC**11T3**
SDJCR/L2525M11	•	•		25	25	150	25	32	29	DC**11T3**
SDJCR/L3225P11	•	•		32	25	170	32	32	29	DC**11T3**







● Ex stock ○ On demand

* With internal cooling

Spare parts

	Insert	DC**0702**	DC**11T3**
	h	10-16	16-32
 Screw		I60M2.5×6.5 (1.0 Nm)	I60M3.5×12 (2.7 Nm)
 Screw (shim)			SM5×8.65XA
 Shim			D11BS
 Wrench (screw)		WT07IP	WT15IP
 Wrench (shim)			WH35L

Insert

					
Finishing A126	Medium Cut A127	Roughing A129	Alum Machining A129	Cast Iron A129	PCBN/PCD A184

System code > A228

Grade selection > A42

Technical info > A501

Cutting data > A366

DC holder (external)** S-Clamping

SDNCN Kr: 62°30'

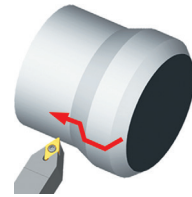
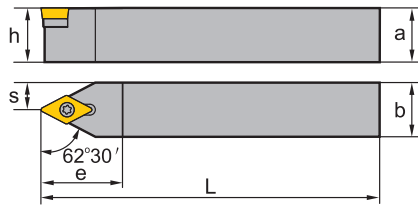
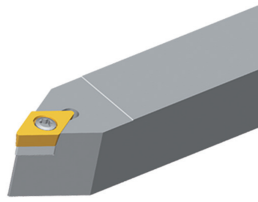

Article	*	Stock	Dimensions [mm]						Inserts
			a	b	L	h	s	e	
SDNCN1010E07	●		10	10	70	10	5	20	DC**0702**
SDNCN1212F07	●		12	12	80	12	6	20	DC**0702**
SDNCN1212H11	●		12	12	100	12	6	30	DC**11T3**
SDNCN1616H11	●		16	16	100	16	8	30	DC**11T3**
SDNCN2020K11	●		20	20	125	20	10	30	DC**11T3**
SDNCN2525M11	●		25	25	150	25	12.5	30	DC**11T3**

● Ex stock ○ On demand

* With internal cooling

Spare parts				
	Insert	DC**0702**	DC**11T3**	DC**11T3**
	h	10-12	12	16-25
	Screw	I60M2.5x6.5 (1.0 Nm)	I60M3.5x8 (2.7 Nm)	I60M3.5x12 (2.7 Nm)
	Screw (shim)			SM5x8.65XA
	Shim			D11BS
	Wrench (screw)	WT07IP	WT15IP	WT15IP
	Wrench (shim)			WH35L

Insert					
Finishing	Medium Cut	Roughing	Alum Machining	Cast Iron	PCBN/PCD
A126	A127	A129	A129	A129	A184

VB** holder (external) S-Clamping

SVJBR/L Kr: 93°

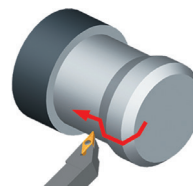
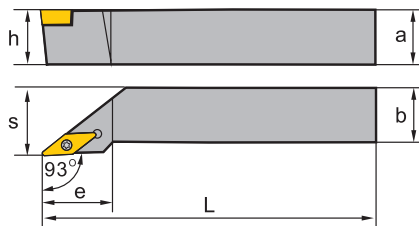
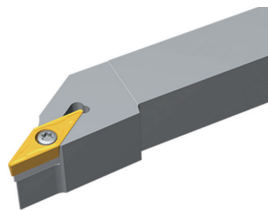





Right hand style

Article	*	Stock		Dimensions [mm]						Inserts
		R	L	a	b	L	h	s	e	
SVJBR/L1212F11		●		12	12	80	12	16	27	VB**1103**
SVJBR/L1616H11		●	●	16	16	100	16	20	27	VB**1103**
SVJBR/L2525M11		●	●	25	25	150	25	32	27	VB**1103**
SVJBR/L1616H16		●	●	16	16	100	16	20	36	VB**1604**
SVJBR/L2020K16		●	●	20	20	125	20	25	41	VB**1604**
SVJBR/L2525M16		●	●	25	25	150	25	32	41	VB**1604**
SVJBR/L3225P16		●	●	32	25	170	32	32	41	VB**1604**





● Ex stock ○ On demand

* With internal cooling

Spare parts

	Insert	VB**1103**	VB**1604**
	h	12-25	16-32
	Screw	I60M2.5×6.5 (1.0 Nm)	I60M3.5×12 (2.7 Nm)
	Screw (shim)		SM5×8.65XA
	Shim		V16BS
	Wrench (screw)	WT07IP	WT15IP
	Wrench (shim)		WH35L

Insert

			
Finishing	Medium Cut	Roughing	PCBN/PCD
A148	A151	A152	A191

System code > A228

Grade selection > A42

Technical info > A501

Cutting data > A366

VB holder (external) S-Clamping**

SVABR/L Kr: 90°

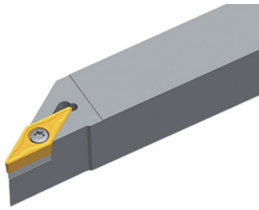

Right hand style

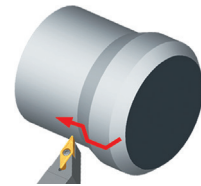
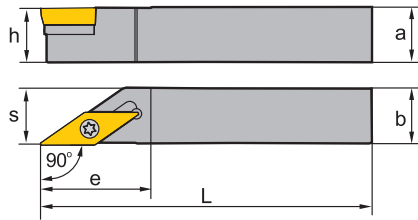





Article	*	Stock		Dimensions [mm]						Inserts
		R	L	a	b	L	h	s	e	
SVABR/L1010F11		●	●	10	10	80	10	10.5	28	VB**1103**
SVABR/L1616H16		●	○	16	16	100	16	16.5	28	VB**1604**
SVABR/L2020K16		●	○	20	20	125	20	20.5	28	VB**1604**
SVABR/L2525M16		●	●	25	25	150	25	25.5	28	VB**1604**





● Ex stock ○ On demand

* With internal cooling

Spare parts

	Insert	VB**1103**	VB**1604**
	h	10	16-32
	Screw	I60M2.5×6.5 (1.0 Nm)	I60M3.5×12 (2.7 Nm)
	Screw (shim)		SM5×8.65XA
	Shim		V16BS
	Wrench (screw)	WT07IP	WT15IP
	Wrench (shim)		WH35L

Insert

			
Finishing A148	Medium Cut A151	Roughing A152	PCBN/PCD A191

A

VB** holder (external) S-Clamping

SVVBN Kr: 72°30'

Turning

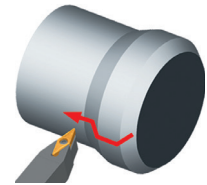
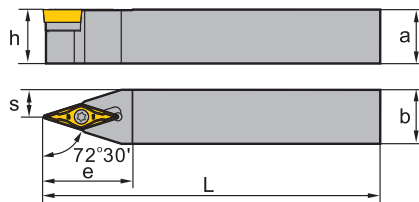
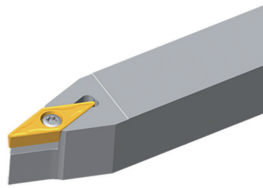

B

Milling

Article	*	Stock	Dimensions [mm]						Inserts
			a	b	L	h	s	e	
SVVBN1616H11	●	●	16	16	100	16	8	27	VB**1103**
SVVBN2020K11	●	●	20	20	125	20	10	30	VB**1103**
SVVBN1616H16	●	●	16	16	100	16	8	33	VB**1604**
SVVBN2020K16	●	●	20	20	125	20	10	33	VB**1604**
SVVBN2525M16	●	●	25	25	150	25	12.5	38	VB**1604**

● Ex stock ○ On demand

* With internal cooling

C

Drilling

Spare parts			
	Insert	VB**1103**	VB**1604**
	h	12-25	16-32
	Screw	I60M2.5×6.5 (1.0 Nm)	I60M3.5×12 (2.7 Nm)
	Screw (shim)		SM5×8.65XA
	Shim		V16BS
	Wrench (screw)	WT07IP	WT15IP
	Wrench (shim)		WH35L

D

Technical Information

Insert			
Finishing	Medium Cut	Roughing	PCBN/PCD
A148	A151	A152	A191

E

Index

System code > A228

Grade selection > A42

Technical info > A501

Cutting data > A366

VC holder (external)** S-Clamping

SVVCN Kr: 72°30'

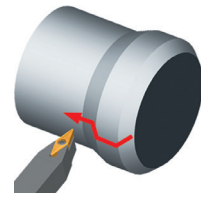
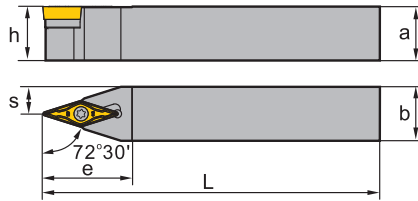
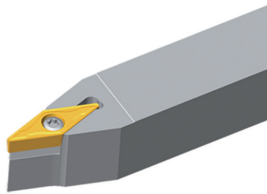

Article	*	Stock	Dimensions [mm]						Inserts
			a	b	L	h	s	e	
SVVCN1212F11		●	12	12	80	12	6	27	VC**1103**
SVVCN1616H11		●	16	16	100	16	8	27	VC**1103**
SVVCN2020K11		●	20	20	125	20	10	30	VC**1103**
SVVCN1212M11		●	12	12	150	12	6	27	VC**1103**
SVVCN2525M11		●	25	25	150	25	12.5	38	VC**1103**
SVVCN1616H16		●	16	16	100	16	8	33	VC**1604**
SVVCN2020K16		●	20	20	125	20	10	33	VC**1604**
SVVCN2525M16		●	25	25	150	25	12.5	38	VC**1604**

● Ex stock ○ On demand

* With internal cooling

Spare parts			
	Insert	VC**1103**	VC**1604**
		12-25	16-32
	Screw	I60M2.5×6.5 (1.0 Nm)	I60M3.5×12 (2.7 Nm)
	Screw (shim)		SM5×8.65XA
	Shim		V16BSC
	Wrench (screw)	WT07IP	WT15IP
	Wrench (shim)		WH35L

Insert			
Finishing	Medium Cut	Alum Machining	PCBN/PCD
A156	A156	A154	A193

VC** holder (external) S-Clamping

SVJCR/L Kr: 93°

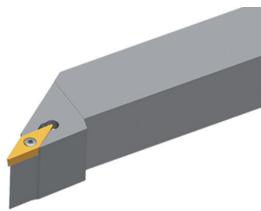

Right hand style

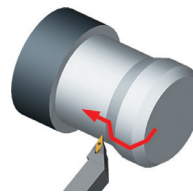
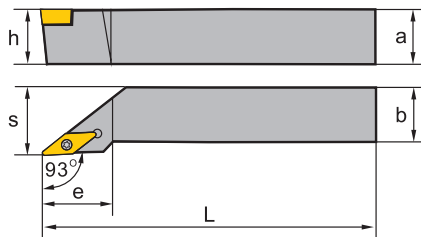

Article	*	Stock		Dimensions [mm]						Inserts
		R	L	a	b	L	h	s	e	
SVJCR/L1010E11	●			10	10	70	10	12	22	VC**1103**
SVJCR/L1212F11	●	●		12	12	80	12	16	27	VC**1103**
SVJCR/L1616H11	●	●		16	16	100	16	20	27	VC**1103**
SVJCR/L2020K11	●	●		20	20	125	20	25	27	VC**1103**
SVJCR/L2525M11	●	●		25	25	150	25	32	27	VC**1103**
SVJCR/L1616H16	●	●		16	16	100	16	20	36	VC**1604**
SVJCR/L2020K16	●	●		20	20	125	20	25	41	VC**1604**
SVJCR/L2020M16	●	●		20	20	150	20	25	41	VC**1604**
SVJCR/L2525M16	●	●		25	25	150	20	32	41	VC**1604**
SVJCR/L3225P16	○	○		32	25	170	32	32	41	VC**1604**

● Ex stock ○ On demand

* With internal cooling

Spare parts

	Insert	VC**1103**	VC**1604**
		10-25	16-32
Screw		I60M2.5×6.5 (1.0 Nm)	I60M3.5×12 (2.7 Nm)
Screw (shim)			SM5×8.65XA
Shim			V16BSC
Wrench (screw)		WT07IP	WT15IP
Wrench (shim)			WH35L

Insert

Finishing	Medium Cut	Alum Machining	PCBN/PCD
A156	A156	A154	A193

System code > A228

Grade selection > A42

Technical info > A501

Cutting data > A366

SC steel boring bar S-Clamping**

SSBCR/L Kr: 75°

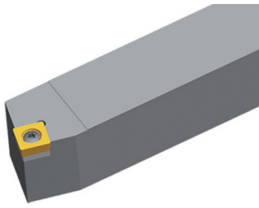

Right hand style

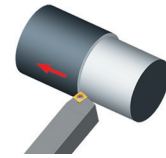
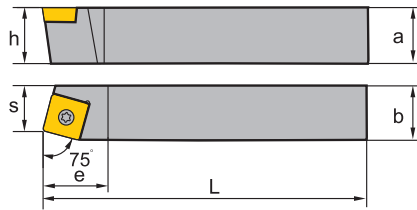







Article	*	Stock		Dimensions [mm]						Inserts
		R	L	a	b	L	h	s	e	
SSBCR/L1212F09	•	•	12	12	80	12	11	16	SC**09T3**	
SSBCR/L1616H09	•	•	16	16	100	16	13	16	SC**09T3**	
SSBCR/L2020K12	•	•	20	20	125	20	17	25	SC**1204**	





● Ex stock ○ On demand

* With internal cooling

Spare parts

	Insert	SC**09T3**	SC**09T3**	SC**1204**
	h	12	16	20
	Screw	I60M3.5x8 (2.7 Nm)	I60M3.5x8 (2.7 Nm)	
	Screw			I60M4x11X (3.4 Nm)
	Screw (shim)		SM5x8.65XA	SM6x10XA
	Shim		S09BS	S12BS
	Wrench (screw)	WT15IP	WT15IP	WT15IP
	Wrench (shim)		WH35L	WH40L

Insert

			
Finishing A134	Medium Cut A135	Roughing A136	Alum Machining A136

System code > A228

Grade selection > A42

Technical info > A501

Cutting data > A366

A

SC** steel boring bar S-Clamping

SSDCN Kr: 45°

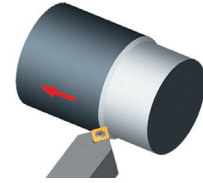
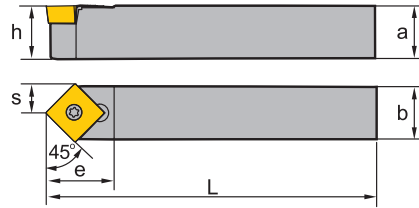
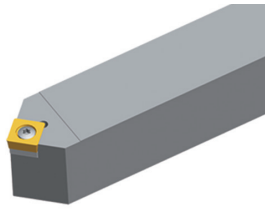

Right hand style

Turning

B

Article	*	Stock	Dimensions [mm]						Inserts
			a	b	L	h	s	e	
SSDCN1212F09	●		12	12	80	12	6	15.5	SC**09T3**
SSDCN1616H09	●		16	16	100	16	8	15.5	SC**09T3**





Milling

● Ex stock ○ On demand

* With internal cooling

C





Spare parts

	Insert	SC**09T3**	SC**09T3**
	h	12	16
	Screw	I60M3.5×8 (2.7 Nm)	I60M3.5×8 (2.7 Nm)
	Screw (shim)		SM5×8.65XA
	Shim		S09BS
	Wrench (screw)	WT15IP	WT15IP
	Wrench (shim)		WH35L

Drilling

D

Insert

			
Finishing	Medium Cut	Roughing	Alum Machining
A134	A135	A136	A136

Technical Information

E

Index

System code > A228

Grade selection > A42

Technical info > A501

Cutting data > A366

SC steel boring bar S-Clamping**

SSKCR/L Kr: 75°

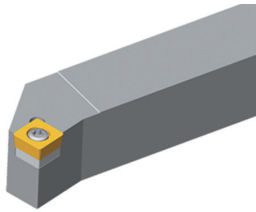

Right hand style

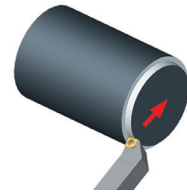
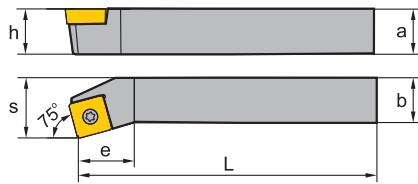





Article	*	Stock		Dimensions [mm]						Inserts
		R	L	a	b	L	h	s	e	
SSKCR/L1616H09		●	●	16	16	100	16	20	13	SC**09T3**





● Ex stock ○ On demand

* With internal cooling

Spare parts

	Insert	SC**09T3**
	h	16
	Screw	I60M3.5×8 (2.7 Nm)
	Screw (shim)	SM5×8.65XA
	Shim	S09BS
	Wrench (screw)	WT15IP
	Wrench (shim)	WH35L

Insert

			
Finishing	Medium Cut	Roughing	Alum Machining
A134	A135	A136	A136

System code > A228

Grade selection > A42

Technical info > A501

Cutting data > A366

SC** steel boring bar S-Clamping

SSSCR/L Kr: 45°

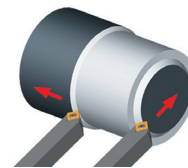
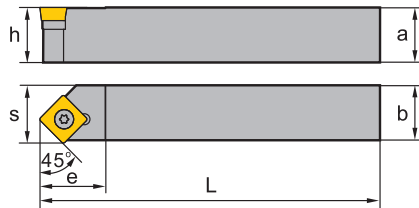
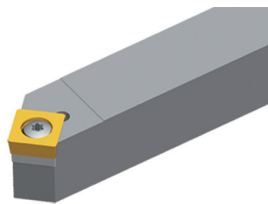







Right hand style

Article	*	Stock		Dimensions [mm]						Inserts
		R	L	a	b	L	h	s	e	
SSSCR/L1616H09	•	•		16	16	100	16	17	17	SC**09T3**
SSSCR/L2020K12	•	•		20	20	125	20	21	21	SC**1204**





● Ex stock ○ On demand

* With internal cooling

Spare parts

	Insert	SC**09T3**	SC**1204**
	h	16	20
	Screw	I60M3.5×12 (2.7 Nm)	
	Screw		I60M4×11X (3.4 Nm)
	Screw (shim)		SM6×10XA
	Shim		S12BS
	Wrench (screw)	WT15IP	WT15IP
	Wrench (shim)		WH40L

Insert

			
Finishing	Medium Cut	Roughing	Alum Machining
A134	A135	A136	A136

System code > A228

Grade selection > A42

Technical info > A501

Cutting data > A366

TC holder (external) S-Clamping**

STACR/L Kr: 90°

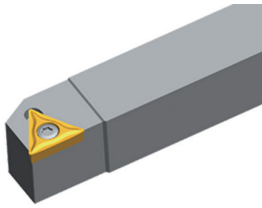

Right hand style

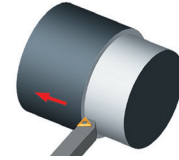
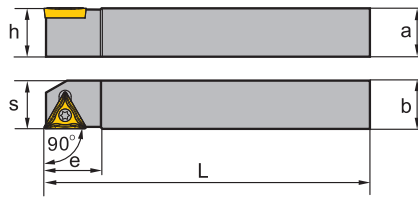



Article	*	Stock		Dimensions [mm]						Inserts
		R	L	a	b	L	h	s	e	
STACR/L1212F11		●	●	12	12	80	12	12.5	14	TC**1102**

● Ex stock ○ On demand

* With internal cooling

Spare parts

	Insert	TC**1102**
	h	12
	Screw	I60M2.5x6.5 (1.0 Nm)
	Wrench (screw)	WT07IP

Insert

				
Finishing	Medium Cut	Roughing	Alum Machining	PCBN/PCD
A141	A142	A143	A145	A187

A

Turning

B

Milling

C

Drilling

D

Technical Information

E

Index

System code > A228

Grade selection > A42

Technical info > A501

Cutting data > A366

A

TC** holder (external) **S-Clamping**

STFCR/L Kr: 91°

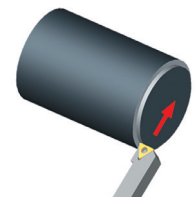
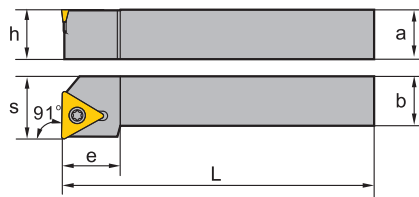
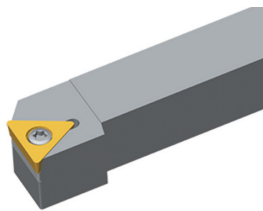

Right hand style

Turning

B

Article	*	Stock		Dimensions [mm]						Inserts
		R	L	a	b	L	h	s	e	
STFCR/L1212F11	● ○	●	○	12	12	80	12	16	14	TC**1102**
STFCR/L1616H11	● ○	●	○	16	16	100	16	20	14	TC**1102**
STFCR/L1616H16	● ○	●	○	16	16	100	16	20	19	TC**16T3**
STFCR/L2020K16	● ●	●	●	20	20	125	20	25	19	TC**16T3**

● Ex stock ○ On demand

* With internal cooling

Milling

C

Spare parts

	Insert	TC**1102**	TC**16T3**
	h	12-16	16-20
	Screw	I60M2.5×6.5 (1.0 Nm)	I60M3.5×12 (2.7 Nm)
	Screw (shim)		SM5×8.65XA
	Shim		T16BS
	Wrench (screw)	WT07IP	WT15IP
	Wrench (shim)		WH35L

Drilling

D

Insert

Finishing	Medium Cut	Roughing	Alum Machining	Cast Iron	PCBN/PCD
A141	A142	A143	A145	A143	A187

Technical Information

E

Index

System code > A228

Grade selection > A42

Technical info > A501

Cutting data > A366

TC** holder (external) **S-Clamping**

STGCR/L Kr: 91°

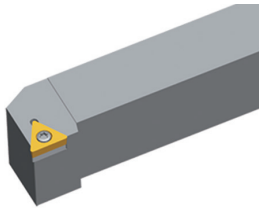

Right hand style

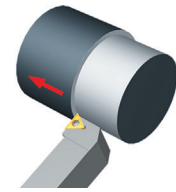

Article	*	Stock		Dimensions [mm]						Inserts
		R	L	a	b	L	h	s	e	
STGCR/L0808D09	○			8	8	60	8	10	11	TC**0902**
STGCR/L1010E09	●	○		10	10	70	10	12	11	TC**0902**
STGCR/L1212F11	●	●		12	12	80	12	16	14	TC**1102**
STGCR/L1616H11	●	●		16	16	100	16	20	16	TC**1102**
STGCR/L2020K16	●	●		20	20	125	20	25	21	TC**16T3**
STGCR/L2525M16	●	●		25	25	150	25	25	21	TC**16T3**

● Ex stock ○ On demand

* With internal cooling

Spare parts		TC**0902**	TC**1102**	TC**16T3**
Insert h		8-10	12-16	20-25
	Screw	I60M2.2x5.5 (0.8 Nm)	I60M2.5x6.5 (1.0 Nm)	I60M3.5x12 (2.7 Nm)
	Screw (shim)			SM5x8.65XA
	Shim			T16BS
	Wrench (screw)	WT06IP	WT07IP	WT15IP
	Wrench (shim)			WH35L

Insert					
Finishing A141	Medium Cut A142	Roughing A143	Alum Machining A145	Cast Iron A143	PCBN/PCD A187

System code > A228

Grade selection > A42

Technical info > A501

Cutting data > A366



A

Turning

B

Milling

C

Drilling

D

Technical Information

E

Index

A

Turning

TC** holder (external) **S-Clamping**

STTCR/L Kr: 60°

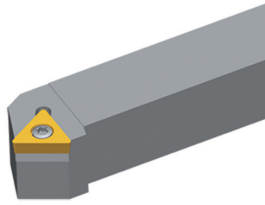

Right hand style

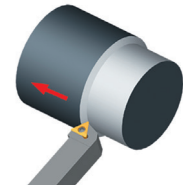

B

Milling

Article	*	Stock		Dimensions [mm]						Inserts
		R	L	a	b	L	h	s	e	
STTCR/L1616H11	● ○	●	○	16	16	100	16	13	14	TC**1102**
STTCR/L1616H16	● ●	●	●	16	16	100	16	13	19	TC**16T3**
STTCR/L2020K16	● ●	●	●	20	20	125	20	17	19	TC**16T3**

● Ex stock ○ On demand

* With internal cooling

C

Drilling

Spare parts

	Insert	TC**1102**	TC**16T3**
	h	16	16-20
	Screw	I60M2.5×6.5 (1.0 Nm)	I60M3.5×12 (2.7 Nm)
	Screw (shim)		SM5×8.65XA
	Shim		T16BS
	Wrench (screw)	WT07IP	WT15IP
	Wrench (shim)		WH35L

D

Technical Information

Insert

Finishing	Medium Cut	Roughing	Alum Machining	Cast Iron	PCBN/PCD
A141	A142	A143	A145	A143	A187

E

Index

System code > A228

Grade selection > A42

Technical info > A501

Cutting data > A366

WC holder (external) S-Clamping**

SWACR/L Kr: 90°

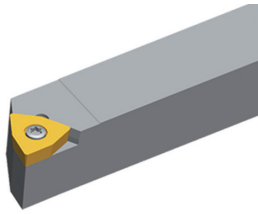

Right hand style

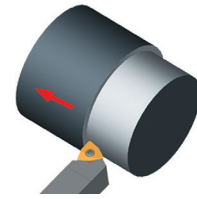
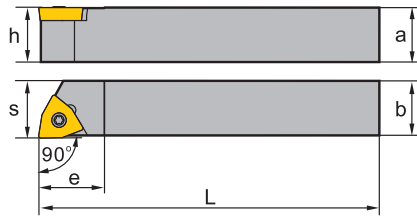

Article	*	Stock		Dimensions [mm]						Inserts
		R	L	a	b	L	h	s	e	
SWACR/L1010E04		●	○	10	10	70	10	10.5	10	WC**0402**
SWACR/L1212F04		●	○	12	12	80	12	12	14	WC**0402**
SWACR/L1616H06		●	●	16	16	100	16	16.5	20	WC**06T3**
SWACR/L2020K08		●	●	20	20	125	20	20.5	24	WC**0804**

● Ex stock ○ On demand

* With internal cooling

Spare parts				
	Insert	WC**0402**	WC**06T3**	WC**0804**
	h	10-12	16	20
	Screw	I60M2.5×6.5 (1.0 Nm)	I60M3×7 (1.8 Nm)	I60M3.5×12 (2.7 Nm)
	Wrench (screw)	WT07IP	WT10IP	WT15IP

Insert



Medium Cut

C35

A

Turning

B

Milling

C

Drilling

D

Technical Information

E

Index

RC** holder (external) S-Clamping

SRDCN

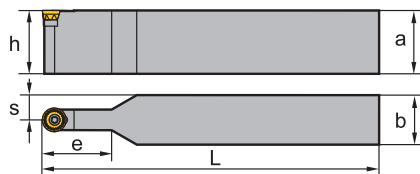
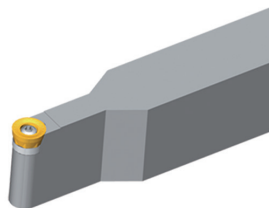

Article	*	Stock	Dimensions [mm]						Inserts	
			a	b	L	h	s	e		
SRDCN1616H08		○	16	16	100	16	8	16	RCGX0803MO	RCMT0803MO
SRDCN2020K08		●	20	20	125	20	10	16	RCGX0803MO	RCMT0803MO
SRDCN2020K12		●	20	20	125	20	10	35	RCGX1204MO	RCMT1204MO
SRDCN2525M12		●	25	25	150	25	12.5	35	RCGX1204MO	RCMT1204MO
SRDCN3225P12		●	32	25	170	32	12.5	35	RCGX1204MO	RCMT1204MO
SRDCN2020K10		●	20	20	125	20	10	25	RCMT10T3MO	
SRDCN2525M10		●	25	25	150	25	12.5	25	RCMT10T3MO	
SRDCN3225P16		●	32	25	170	32	12.5	35	RCMT1606MO	
SRDCN3232P16		●	32	32	170	32	16	40	RCMT1606MO	
SRDCN4040S16		●	40	40	250	40	20	50	RCMT1606MO	
SRDCN4040S20		●	40	40	250	40	20	50	RCMT2006MO	

● Ex stock ○ On demand

* With internal cooling

Spare parts

	Insert	RCGX0803MO	RCGX1204MO	RCMT10T3MO	RCMT1606MO	RCMT2006MO
	h	16-20	20-32	20-25	32-40	40
	Screw	I60M3×7 (1.8 Nm)	I60M3.5×12 (2.7 Nm)	I60M3.5×10 (2.7 Nm)		I43M6×16 (9.1 Nm)
	Screw				I60M4×15X (3.4 Nm)	
	Screw (shim)		SM5×8.65XA		SM6×10XA	
	Shim		R12BS		R16BS	
	Wrench (screw)	WT10IP	WT15IP	WT15IP	WT15IP	
	Wrench (screw)					WT25IT
	Wrench (shim)		WH35L		WH40L	

Insert

Alum Machining	Cast Iron
A132	A132

System code > A228

Grade selection > A42

Technical info > A501

Cutting data > A366

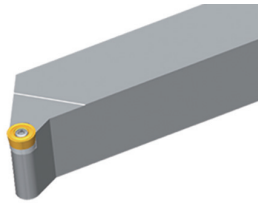

RC** holder (external) **S-Clamping**

SRGCR/L



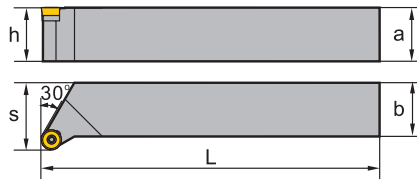



Right hand style





Article	*	Stock		Dimensions [mm]					Inserts	
		R	L	a	b	L	h	s		
SRGCR/L1616H08		●	●	16	16	100	16	20	RCGX0803MO-LH	RCMT0803MO
SRGCR/L2020K12		●	○	20	20	125	20	27	RCGX1204MO	RCMT1204MO
SRGCR/L2525M12		●	○	25	25	150	25	32	RCGX1204MO	RCMT1204MO
SRGCR/L2525M10		●	○	25	25	100	25	32	RCMT10T3MO	
SRGCR/L2020K10		●	○	20	20	125	20	25	RCMT10T3MO	

● Ex stock ○ On demand

* With internal cooling

Spare parts		RCGX0803MO-LH	RCGX1204MO	RCMT10T3MO
Insert h		16	20-25	16-25
	Screw	I60M3.5×10 (2.7 Nm)	I60M3.5×12 (2.7 Nm)	I60M3.5×10 (2.7 Nm)
	Screw (shim)		SM5×8.65XA	
	Shim		R12BS	
	Wrench (screw)	WT15IP	WT15IP	WT15IP
	Wrench (shim)		WH35L	

Insert	
	
Alum Machining	Cast Iron
A132	A132

System code > A228

Grade selection > A42

Technical info > A501

Cutting data > A366

KNUX** holder C-Clamping

CKJNR/L Kr: 93°

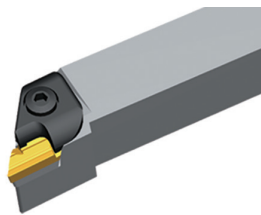

Right hand style

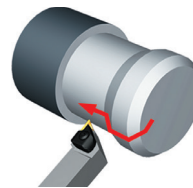
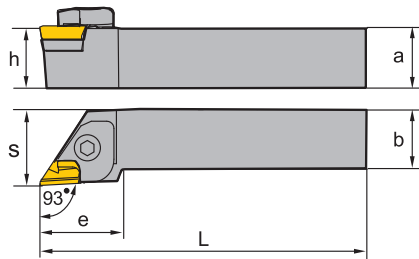

Article	*	Stock		Dimensions [mm]						Inserts
		R	L	a	b	L	h	s	e	
CKJNL2525M16	●			25	25	150	25	32	32	KNUX1604**L
CKJNL3232P16	●			32	32	170	32	40	32	KNUX1604**L
CKJNL4040R16	●			40	40	200	40	50	32	KNUX1604**L
CKJNR2525M16	●			25	25	150	25	32	32	KNUX1604**R
CKJNR3232P16	●			32	32	170	32	40	32	KNUX1604**R
CKJNR4040R16	○			40	40	200	40	50	32	KNUX1604**R

● Ex stock ○ On demand

* With internal cooling

Spare parts			
	Insert	KNUX1604**L	KNUX1604**R
	h	25-40	25-40
	Clamp	C6L1T	C6R1T
	Dowel pin	P0515	P0515
	Screw (clamp)	CM6×25A (7.0 Nm)	CM6×25A (7.0 Nm)
	Screw (shim)	SM3×10B	SM3×10B
	Shim		K16CC
	Shim	K16CCL	
	Spring (clamp)	SPR1	SPR1
	Spring (dowel pin)	SPR2	SPR2
	Wrench (clamp)	WH40L	WH40L
	Wrench (shim)	WH20L	WH20L

Insert



Finishing

A113

System code > A228

Grade selection > A42

Technical info > A501

Cutting data > A366

KNUX holder** **C-Clamping**

CKNNR/L Kr: 63°

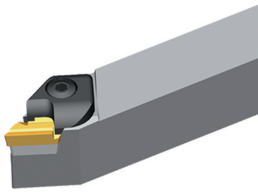

Right hand style

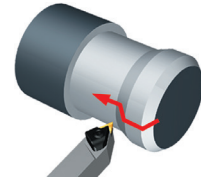
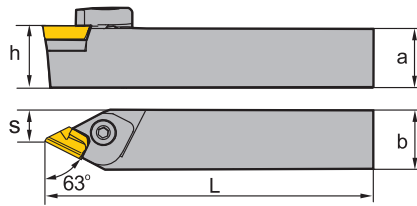











Article	*	Stock		Dimensions [mm]					Inserts 
		R	L	a	b	L	h	s	
CKNNL2525M16	●			25	25	150	25	14.3	KNUX1604**L
CKNNL3232P16	○			32	32	170	32	16.8	KNUX1604**L
CKNNR2525M16	●			25	25	150	25	14.3	KNUX1604**R

● Ex stock ○ On demand

* With internal cooling

Spare parts

	Insert	KNUX1604**L	KNUX1604**R
	h	25-32	25-32
	Clamp	C6L1T	C6R1T
	Dowel pin	P0515	P0515
	Screw (clamp)	CM6×25A (7.0 Nm)	CM6×25A (7.0 Nm)
	Screw (shim)	SM3×10B	SM3×10B
	Shim		K16CC
	Shim	K16CCL	
	Spring (clamp)	SPR1	SPR1
	Spring (dowel pin)	SPR2	SPR2
	Wrench (clamp)	WH40L	WH40L
	Wrench (shim)	WH20L	WH20L

Insert



Finishing

A113

System code > A228

Grade selection > A42

Technical info > A501

Cutting data > A366



A

Turning

B

Milling

C

Drilling

D

Technical Information

E

Index

CN** holder (external) C-Clamping

CCLNR/L Kr: 95°

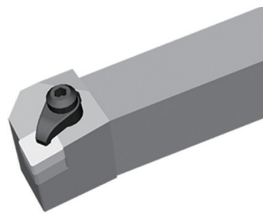

Right hand style

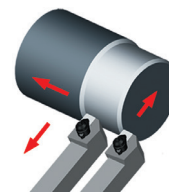
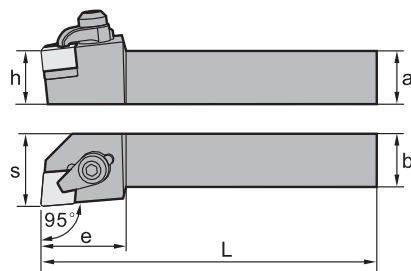

Article	*	Stock		Dimensions [mm]						Inserts	
		R	L	a	b	L	h	s	e		
CCLNR/L2020K12	*	○	○	20	20	125	20	27	32	CNGN1204**	CNGN1207**
CCLNR/L2525M12	*	○	●	25	20	100	25	27	36	CNGN1204**	CNGN1207**
CCLNR/L2525M16	*	○	○	25	25	150	25	32	36	CNGN1604**	CNGN1606**
CCLNR/L3225P16	*	○	○	32	25	170	32	32	36	CNGN1604**	CNGN1606**

● Ex stock ○ On demand

* With internal cooling

Spare parts

	Insert	CNGN1204**	CNGN1207**	CNGN1604**	CNGN1606**
	h	20-25	20-25	25-32	25-32
	Clamp	C1RC	C1RC	C2RC	C2RC
	Screw (clamp)	CM6×30B (7.0 Nm)	CM6×30B (7.0 Nm)	CM8×30B (10.2 Nm)	CM8×30B (10.2 Nm)
	Screw (shim)	SM3×10B	SM3×10B	SM4×12B	SM4×12B
	Shim	C12CC-04	C12CC-07	C16CC-04	C16CC-06
	Spring	SPR1	SPR1	SPR3	SPR3
	Wrench (clamp)	WH40L	WH40L	WH50L	WH50L
	Wrench (shim)	WH20L	WH20L	WH30L	WH30L

Insert



PCBN/PCD

A173

TN holder (external) C-Clamping**

CTJNR/L Kr: 93°

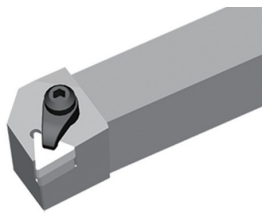

Right hand style

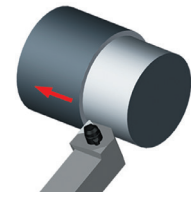
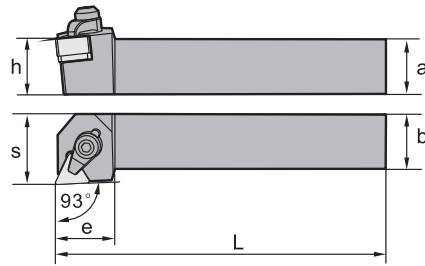

Article	*	Stock		Dimensions [mm]						Inserts	
		R	L	a	b	L	h	s	e		
CTJNR/L2020K16		○	○	20	20	125	20	25	30	TNGN1604**	TNGN1607**
CTJNR/L2525M16		○	○	25	25	150	25	32	30	TNGN1604**	TNGN1607**

● Ex stock ○ On demand

* With internal cooling

Spare parts

	Insert	TNGN1604**	TNGN1607**
	h	20-25	20-25
	Clamp	C1RC	C1RC
	Screw (clamp)	CM6×30B (7.0 Nm)	CM6×30B (7.0 Nm)
	Screw (shim)	SM3×10B	SM3×10B
	Shim	T16CC-04	T16CC-07
	Spring	SPR1	SPR1
	Wrench (clamp)	WH40L	WH40L
	Wrench (shim)	WH20L	WH20L

Insert



Medium Cut

A218

A

Turning

B

Milling

C

Drilling

D

Technical Information

E

Index

DN** holder (external) C-Clamping

CDJNR/L Kr: 93°

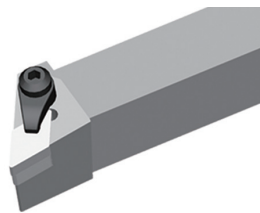

Right hand style

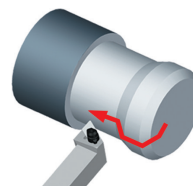
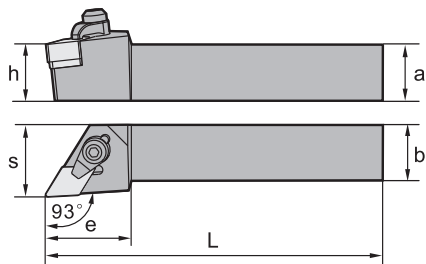

Article	*	Stock		Dimensions [mm]						Inserts	
		R	L	a	b	L	h	s	e		
CDJNR/L2525M15	●	●		25	25	150	25	32	32	DNGN1504**	DNGN1507**
CDJNR/L3225P15	○	○		32	25	170	32	32	32	DNGN1504**	DNGN1507**

● Ex stock ○ On demand

* With internal cooling

Spare parts

	Insert	DNGN1504**	DNGN1507**
	h	25-32	25-32
	Clamp	C1RC	C1RC
	Screw (clamp)	CM6×30B (7.0 Nm)	CM6×30B (7.0 Nm)
	Screw (shim)	SM3×10B	SM3×10B
	Shim	D15CC-04	D15CC-07
	Spring	SPR1	SPR1
	Wrench (clamp)	WH40L	WH40L
	Wrench (shim)	WH20L	WH20L

Insert



Medium Cut

A205

System code > A228

Grade selection > A42

Technical info > A501

Cutting data > A366

TN holder (external) C-Clamping**

CTUNR/L Kr: 93°

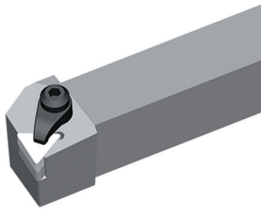

Right hand style

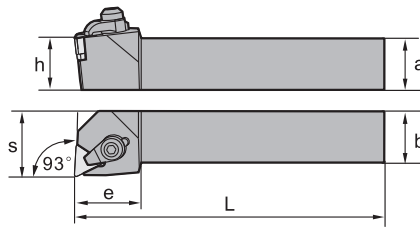

Article	*	Stock		Dimensions [mm]						Inserts	
		R	L	a	b	L	h	s	e		
CTUNR/L2525M16		○	○	25	25	150	25	32	27	TNGN1604**	TNGN1607**

● Ex stock ○ On demand

* With internal cooling

Spare parts

	Insert h	TNGN1604**	TNGN1607**
		20-25	20-25
	Clamp	C1RC	C1RC
	Screw (clamp)	CM6×30B (7.0 Nm)	CM6×30B (7.0 Nm)
	Screw (shim)	SM3×10B	SM3×10B
	Shim	T16CC-04	T16CC-07
	Spring	SPR1	SPR1
	Wrench (clamp)	WH40L	WH40L
	Wrench (shim)	WH20L	WH20L

Insert



Medium Cut

A218

System code > A228

Grade selection > A42

Technical info > A501

Cutting data > A366



A

Turning

B

Milling

C

Drilling

D

Technical Information

E



Index

SN** holder (external) C-Clamping

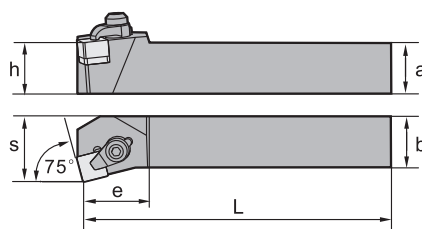
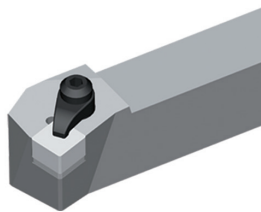
CSKNR/L Kr: 75°









Right hand style

Article	*	Stock		Dimensions [mm]						Inserts	
		R	L	a	b	L	h	s	e		
CSKNR/L2020K12		○	○	20	20	125	20	25	25	SNGN1204**	SNGN1207**
CSKNR/L2525M12		○	○	25	25	170	25	32	25	SNGN1204**	SNGN1207**
CSKNR/L3225P12		○	○	32	25	170	32	32	25	SNGN1204**	SNGN1207**
CSKNR/L3225P15		○	○	32	25	170	32	32	32	SNGN1507**	



● Ex stock ○ On demand

* With internal cooling

Spare parts

	Insert	SNGN1204**	SNGN1207**	SNGN1507**
	h	20-32	20-32	32
 Clamp		C1RC	C1RC	C2RC
 Screw (clamp)		CM6×30B (7.0 Nm)	CM6×30B (7.0 Nm)	CM8×30B (10.2 Nm)
 Screw (shim)		SM3×10B	SM3×10B	SM4×12B
 Shim		S12CC-04	S12CC-07	S15CC-07
 Spring		SPR1	SPR1	SPR3
 Wrench (clamp)		WH40L	WH40L	WH50L
 Wrench (shim)		WH20L	WH20L	WH30L

Insert

	
Cast Iron A86	PCBN/PCD A175

System code > A228

Grade selection > A42

Technical info > A501

Cutting data > A366

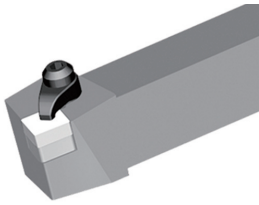

SN holder (external) C-Clamping**

CSRNR/L Kr: 75°

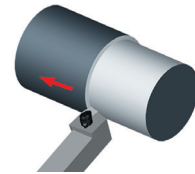
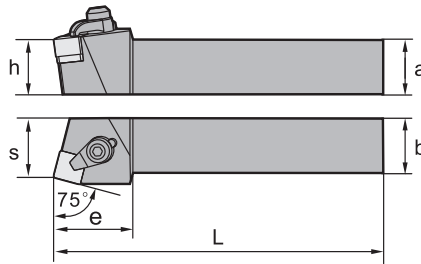

Right hand style









Article	*	Stock		Dimensions [mm]						Inserts	
		R	L	a	b	L	h	s	e		
CSRNR/L2020K12		○	○	20	20	125	20	22	32	SNGN1204**	SNGN1207**
CSRNR/L2525M12		○	○	25	20	100	25	27	32	SNGN1204**	SNGN1207**
CSRNR/L3225P12		○	○	32	25	170	32	27	32	SNGN1204**	SNGN1207**
CSRNR/L3225P15		○		32	25	170	32	32	40	SNGN1507**	
CSRNR/L4040R15		○	○	40	40	200	40	43	40	SNGN1507**	



● Ex stock ○ On demand

* With internal cooling

Spare parts

	Insert h	SNGN1204** 20-32	SNGN1207** 20-32	SNGN1507** 32-40
 Clamp		C1RC	C1RC	C2RC
 Screw (clamp)		CM6×30B (7.0 Nm)	CM6×30B (7.0 Nm)	CM8×30B (10.2 Nm)
 Screw (shim)		SM3×10B	SM3×10B	SM4×12B
 Shim		S12CC-04	S12CC-07	S15CC-07
 Spring		SPR1	SPR1	SPR3
 Wrench (clamp)		WH40L	WH40L	WH50L
 Wrench (shim)		WH20L	WH20L	WH30L

Insert

	
Cast Iron A86	PCBN/PCD A175

System code > A228

Grade selection > A42



Technical info > A501

Cutting data > A366

RN** holder (external) C-Clamping

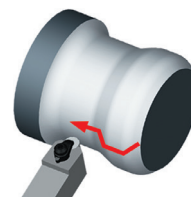
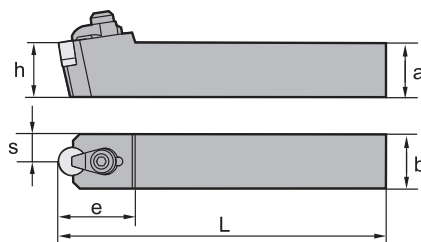
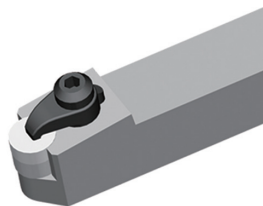
CRDNN









Article	*	Stock	Dimensions [mm]						Inserts	
			a	b	L	h	s	e		
CRDNN2020K12		○	20	20	125	20	10	32	RNGN1204**	RNGN1207**
CRDNN2525M12		○	25	25	150	25	12.5	32	RNGN1204**	RNGN1207**
CRDNN3225P12		○	32	25	170	32	12.5	32	RNGN1204**	RNGN1207**
CRDNN3232P15		○	32	32	170	32	17.5	40	RNGN1507**	
CRDNN4040R15		○	40	40	200	40	20	40	RNGN1507**	

● Ex stock ○ On demand

* With internal cooling

Spare parts

	Insert h	RNGN1204**	RNGN1207**	RNGN1507**
		20-32	20-32	32-40
 Clamp		C1RC	C1RC	C2RC
 Screw (clamp)		CM6×30B (7.0 Nm)	CM6×30B (7.0 Nm)	CM8×30B (10.2 Nm)
 Screw (shim)		SM3×10B	SM3×10B	SM4×12B
 Shim		R12CC-04	R12CC-07	R15CC-07
 Spring		SPR1	SPR1	SPR3
 Wrench (clamp)		WH40L	WH40L	WH50L
 Wrench (shim)		WH20L	WH20L	WH30L

Insert



PCBN/PCD

A174

System code > A228

Grade selection > A42



Technical info > A501

Cutting data > A366

SN holder (external) C-Clamping**

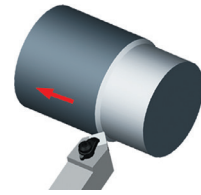
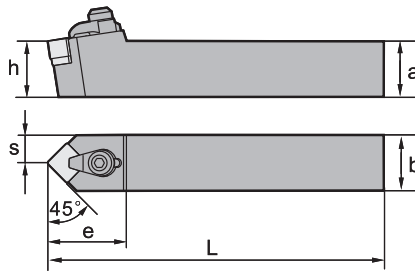
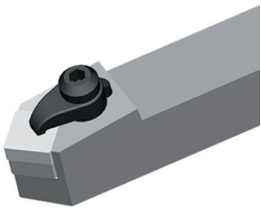
CSDNN Kr: 45°









Article	*	Stock	Dimensions [mm]						Inserts	
			a	b	L	h	s	e		
CSDNN2020K12		○	20	20	125	20	10	35	SNGN1204**	SNGN1207**
CSDNN2525M12		●	25	25	150	25	12.5	30	SNGN1204**	SNGN1207**
CSDNN3225P12		○	32	25	170	32	12.5	35	SNGN1204**	SNGN1207**



● Ex stock ○ On demand

* With internal cooling

Spare parts

	Insert h	SNGN1204** 20-32	SNGN1207** 20-32
	Clamp	C1RC	C1RC
	Screw (clamp)	CM6×30B (7.0 Nm)	CM6×30B (7.0 Nm)
	Screw (shim)	SM3×10B	SM3×10B
	Shim	S12CC-04	S12CC-07
	Spring	SPR1	SPR1
	Wrench (clamp)	WH40L	WH40L
	Wrench (shim)	WH20L	WH20L

Insert

	
Cast Iron A86	PCBN/PCD A175

System code > A228

Grade selection > A42

Technical info > A501

Cutting data > A366

CN** holder (external) J-Clamping

JCLNR/L Kr: 95°

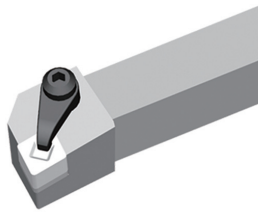

Right hand style

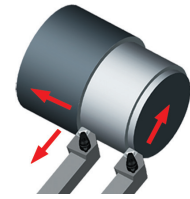
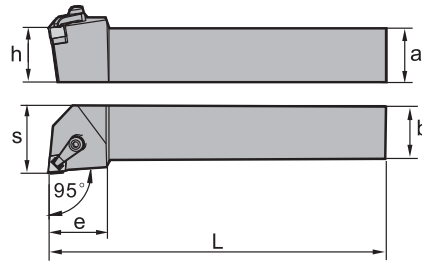







Article	*	Stock		Dimensions [mm]						Inserts
		R	L	a	b	L	h	s	e	
JCLNR/L2020K12		○	○	20	20	125	20	29	32	CNGX1207**
JCLNR/L2525M12		○	○	25	25	150	25	32	32	CNGX1207**

● Ex stock ○ On demand

* With internal cooling

Spare parts

	Insert	CNGX1207**
	h	20-25
	Clamp	C1RJ
	Screw (clamp)	CM6×30B (7.0 Nm)
	Screw (shim)	SM3×10B
	Shim	C12CC-07
	Spring	SPR1
	Wrench (clamp)	WH40L
	Wrench (shim)	WH20L

Insert



Medium Cut

A203

A

Turning

B

Milling

C

Drilling

D

Technical Information

E

Index

System code > A228

Grade selection > A42

Technical info > A501

Cutting data > A366

DN holder (external) J-Clamping**

JDJNR/L Kr: 93°

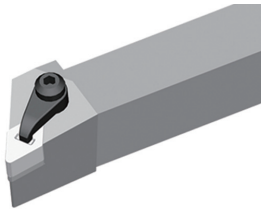

Right hand style

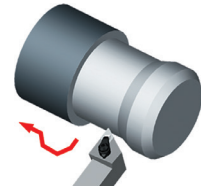
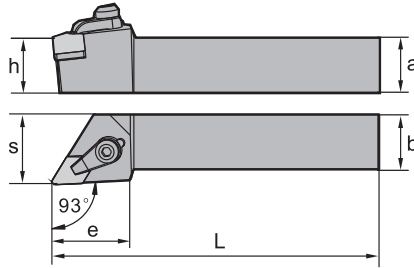







Article	*	Stock		Dimensions [mm]						Inserts
		R	L	a	b	L	h	s	e	
JDJNR/L2525M15	●	○		25	25	150	25	32	38	DNGX1507**
JDJNR/L3225P15	○	○		32	25	170	32	32	38	DNGX1507**

● Ex stock ○ On demand

* With internal cooling

Spare parts

	Insert	DNGX1507**
	h	25-32
	Clamp	C1RJ
	Screw (clamp)	CM6×30B (7.0 Nm)
	Screw (shim)	SM3×10B
	Shim	D15CC-07
	Spring	SPR1
	Wrench (clamp)	WH40L
	Wrench (shim)	WH20L

Insert



Medium Cut

A206

System code > A228

Grade selection > A42

Technical info > A501

Cutting data > A366



A

Turning

B

Milling

C

Drilling

D

Technical Information

E

Index

A

SN** holder (external) J-Clamping

JSDNN Kr: 45°

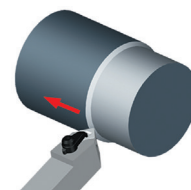
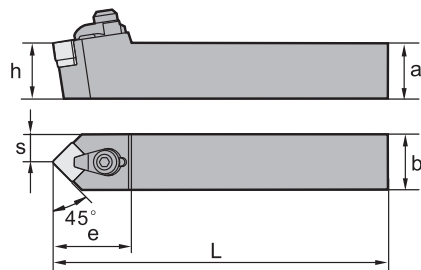
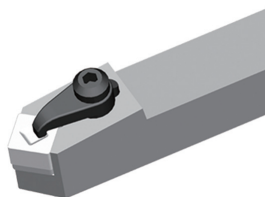

Turning

B

Article	*	Stock	Dimensions [mm]						Inserts
			a	b	L	h	s	e	
JSDNN2525M12	○	○	25	25	150	25	12.5	40	SNGX1207**
JSDNN3225P12	○	○	32	25	170	32	12.5	40	SNGX1207**

Milling

● Ex stock ○ On demand

* With internal cooling

C

Spare parts		
	Insert	SNGX1207**
	h	20-32
	Clamp	C1RJ
	Screw (clamp)	CM6×30B (7.0 Nm)
	Screw (shim)	SM3×10B
	Shim	S12CC-07
	Spring	SPR1
	Wrench (clamp)	WH40L
	Wrench (shim)	WH20L

Drilling

D

Insert
Medium Cut
A216

Technical Information

E

Index

System code > A228

Grade selection > A42

Technical info > A501

Cutting data > A366

S C L N L 25 25 M 12 – S C

1 2 3 4 5 6 7 8 9 10 11

A

Turning

B

Milling

C

Drilling

D







Technical Information

E























Index

Clamping system	
Code	Description
S	Knee lever clamping 







1

Insert shape	
C	
D	
R	
S	
T	
V	
W	



2

Tool holder type and entering angle				
 A	 B	 C	 D	 E
 F	 G	 H	 J	 K
 L	 M	 N	 O	 P
 Q	 R	 S	 T	 U
 V	 W	 X		

3

Clearance angle	
 B	 C
 D	 E
 N	 P





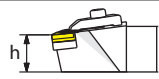

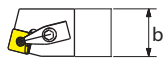
4

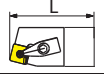
Cutting direction	
	
	
	
5	

Shank height h [mm]	
	
Code	h
12	12
16	16
20	20
25	25
32	32
40	40
50	50
6	

Shank width b [mm]	
	
Code	b
12	12
16	16
20	20
25	25
32	32
40	40
50	50
7	

Holder length L [mm]	
	
Code	L
H	100
K	125
M	150
P	170
Q	180
R	200
S	250
T	300
8	

Cutting edge length l [mm]							
I.C [mm]	Insert shape						
							
	C	D	R	S	T	V	W
5,56	09						
6,35	06	07			11		
9,525	09	11	09	09	16	16	06
12,7	12	15	12	12	22	22	08
15,875	16	19	15	15	27		
19,05	19		19	19	33		
25,4	25		25	25	44		
32			32				
9							

Swissturning
10

With inner cooling
11

A

Turning

B

Milling

C

Drilling

D

Technical Information

E

Index

CC** holder S-Clamping

SCACR/L-SC Kr: 90°

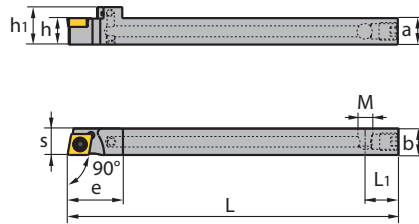
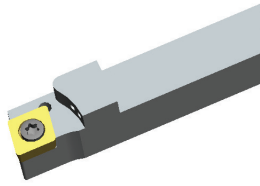

Article	*	Stock		Dimensions [mm]									kg	Inserts
		R	L	a	b	L	h	h ₁	s	L ₁	e	M		
SCACR/L1212M09-SC	*	●	●	12	12	150	12	17	12	15	25	M8X1	0.14	CC**09T3**
SCACR/L1616H09-SC	*	●	●	16	16	100	16	21	16	15	28	M8X1	0.21	CC**09T3**

● Ex stock ○ On demand

* With internal cooling

Spare parts

	Insert	CC**09T3**
	h	12-16
	Screw	I60M3.5x8 (2.7 Nm)
	Wrench	WT15IP

Insert

Finishing	Medium Cut	Roughing	Alum Machining	Cast Iron	PCBN/PCD
A117	A119	A121	A122	A121	A180

System code > A304

Grade selection > A42

Technical info > A501

Cutting data > A366

A

Turning

B

Milling

C

Drilling

D

Technical Information

E

Index

CC holder** S-Clamping

SCLCR/L-SC Kr: 95°

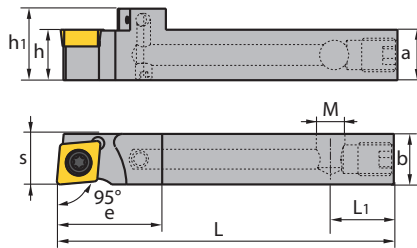
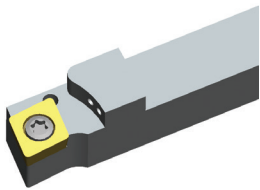

Article	*	Stock		Dimensions [mm]								kg	Inserts	
		R	L	a	b	L	h	h ₁	s	L ₁	e			M
SCLCR/L1010F06-S		●	●	10	10	80	10	15	10	15	10		0.06	CC**0602**
SCLCR/L1212F09-SC	*	●	●	12	12	80	12	17	12	15	25	M8X1	0.07	CC**09T3**

● Ex stock ○ On demand

* With internal cooling

Spare parts

	Insert	CC**0602**	CC**09T3**
	h	10	12
	Screw	I60M2.5×6.5 (1.0 Nm)	I60M3.5×8 (2.7 Nm)
	Wrench	WT07IP	WT15IP

Insert

Finishing	Medium Cut	Roughing	Alum Machining	Cast Iron	PCBN/PCD
A116	A119	A121	A122	A121	A180

DC** holder S-Clamping

SDACR/L-SC Kr: 90°

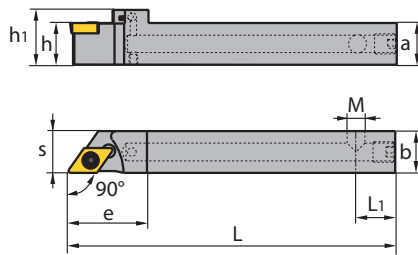
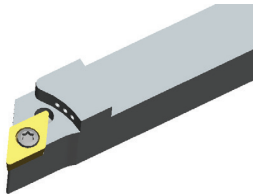

Article	*	Stock		Dimensions [mm]									kg	Inserts
		R	L	a	b	L	h	h ₁	s	L ₁	e	M		
SDACR/L1212M07-SC	*	●	●	12	12	150	12	17	12	15	25	M8X1	0.15	DC**0702**
SDACR/L1212H11-SC	*	○		12	12	100	12	17	12	15	30	M8X1	0.1	DC**11T3**
SDACR/L1616K11-SC	*	●	●	16	16	125	16	21	16	15	30	M8X1	0.21	DC**11T3**
SDACR/L1212M11-SC	*	●	●	12	12	150	12	17	12	15	30	M8X1	0.14	DC**11T3**

● Ex stock ○ On demand

* With internal cooling

Spare parts

	Insert	DC**0702**	DC**11T3**	DC**11T3**
		h	12-16	12
	Screw	I60M2.5×6.5 (1.0 Nm)	I60M3.5×8 (2.7 Nm)	I60M3.5×8 (2.7 Nm)
	Wrench	WT07IP	WT15IP	WT15IP

Insert

Finishing	Medium Cut	Roughing	Alum Machining	Cast Iron	PCBN/PCD
A126	A127	A129	A129	A129	A184

System code > A304

Grade selection > A42

Technical info > A501

Cutting data > A366

DC** holder S-Clamping

SDHCR/L-SC Kr: 107°30'

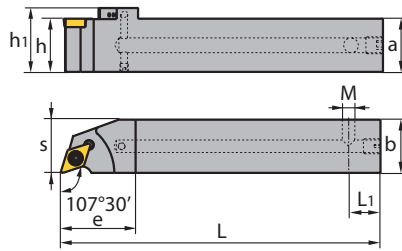
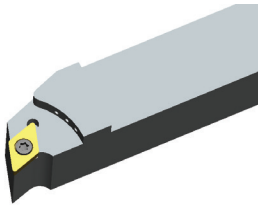

Article	*	Stock	Dimensions [mm]										kg	Inserts
			a	b	L	h	h ₁	s	L ₁	e	M			
SDHCR/L2020K11-SC	*	○	20	20	125	20	25	20	15	30	M8X1	0.35	DC**11T3**	
SDHCR/L2525M11-SC	*	●	25	25	150	25	30	25	15	35	M8X1	0.66	DC**11T3**	

● Ex stock ○ On demand

* With internal cooling

Spare parts

	Insert	DC**11T3**
	h	20-25
	Screw	I60M3.5x8 (2.7 Nm)
	Wrench	WT15IP

Insert

Finishing	Medium Cut	Roughing	Alum Machining	Cast Iron	PCBN/PCD
A126	A127	A129	A129	A129	A184

DC** holder S-Clamping

SDJCR/L-SC Kr: 93°

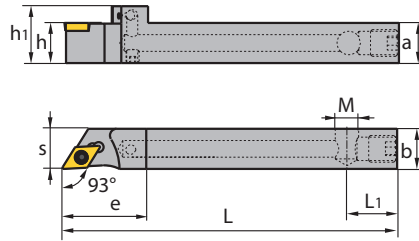
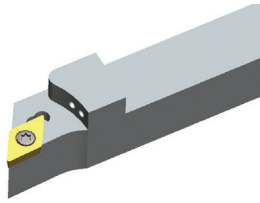

Article	*	Stock		Dimensions [mm]									kg	Inserts
		R	L	a	b	L	h	h ₁	s	L ₁	e	M		
SDJCR/L1212H07-SC	*	●	●	12	12	100	12	17	12	15	25	M8X1	0.1	DC**0702**
SDJCR/L1212H11-SC	*	●	●	12	12	100	12	17	12	15	30	M8X1	0.1	DC**11T3**
SDJCR/L1616K11-SC	*	●	●	16	16	125	16	21	16	15	30	M8X1	0.21	DC**11T3**

● Ex stock ○ On demand

* With internal cooling

Spare parts

	Insert	DC**0702**	DC**11T3**
	h	12	12-16
	Screw	I60M2.5×6.5 (1.0 Nm)	I60M3.5×8 (2.7 Nm)
	Wrench	WT07IP	WT15IP

Insert

Finishing	Medium Cut	Roughing	Alum Machining	Cast Iron	PCBN/PCD
A126	A127	A129	A129	A129	A184

System code > A304

Grade selection > A42

Technical info > A501

Cutting data > A366

DC** holder S-Clamping

SDNCN-SC Kr: 62°30'

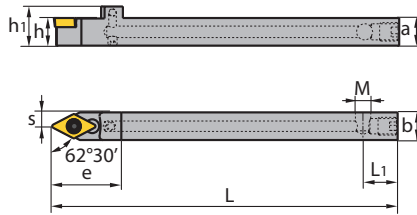
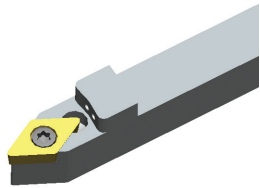

Article	*	Stock	Dimensions [mm]										kg	Inserts
			a	b	L	h	h ₁	s	L ₁	e	M			
SDNCN1212H11-SC	*	○	12	12	100	12	17	6	15	30	M8X1	0.09	DC**11T3**	
SDNCN1212M11-SC	*	●	12	12	150	12	17	6	15	30	M8X1	0.1	DC**11T3**	

● Ex stock ○ On demand

* With internal cooling

Spare parts

	Insert	DC**11T3**
	h	12
	Screw	I60M3.5x8 (2.7 Nm)
	Wrench	WT15IP

Insert

Finishing	Medium Cut	Roughing	Alum Machining	Cast Iron	PCBN/PCD
A126	A127	A129	A129	A129	A184

A

VC** holder S-Clamping

SVACR/L-SC Kr: 90°

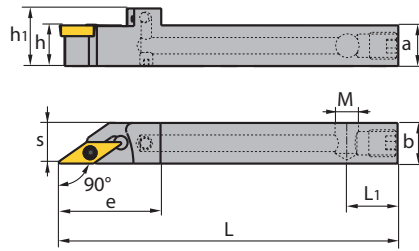
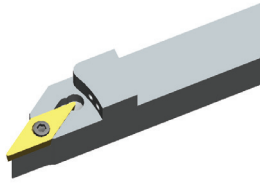

Turning

B

Article	*	Stock		Dimensions [mm]									kg	Inserts
		R	L	a	b	L	h	h ₁	s	L ₁	e	M		
SVACR/L1212H11-SC	*	●	●	12	12	100	12	17	12	15	30	M8X1	0.1	VC**1103**

Milling

● Ex stock ○ On demand

* With internal cooling

Milling

Spare parts

	Insert	VC**1103**
	h	12
	Screw	I60M2.5x6.5 (1.0 Nm)
	Wrench	WT07IP

C

Drilling

Insert

Finishing	Alum Machining	PCBN/PCD
A156	A154	A193

D

Technical Information

E

Index

System code > A304

Grade selection > A42

Technical info > A501

Cutting data > A366

VC** holder S-Clamping

SVJCR/L-SC Kr: 93°

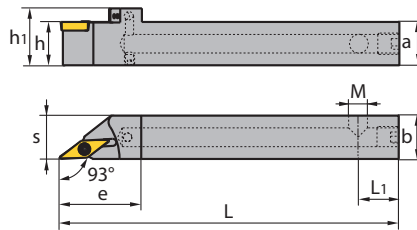
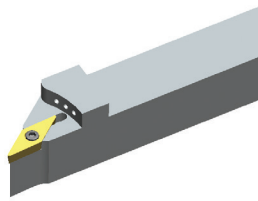

Article	*	Stock		Dimensions [mm]									kg	Inserts
		R	L	a	b	L	h	h ₁	s	L ₁	e	M		
SVJCR/L0808H11-S	●	●	8	8	100	8	13	8	15	22	M8X1	0.044	VC**1103**	
SVJCR/L1212H11-SC	*	●	12	12	100	12	17	12	15	30	M8X1	0.095	VC**1103**	
SVJCR/L1616K11-SC	*	●	16	16	125	16	21	16	15	30	M8X1	0.2	VC**1103**	

● Ex stock ○ On demand

* With internal cooling

Spare parts

Insert	VC**1103**
h	8-16
Screw	I60M2.5x6.5 (1.0 Nm)
Wrench	WT07IP

Insert

Finishing	Alum Machining	PCBN/PCD
A156	A154	A193

A

Turning

B

Milling

C

Drilling

D

Technical Information

E

Index

RW P L F N L/R 19

1 2 3 4 5 6 7

A

Turning

B

Milling

C













Drilling



















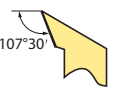

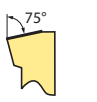
D

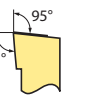
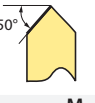
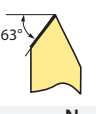
Technical Information

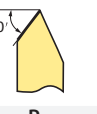
E

Index

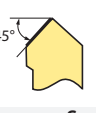
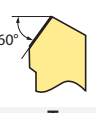
<p>(RW = Rail Way)</p> <p>Tool holders for rail applications</p>	Clamping system		Insert shape	
	Code	Description		
	P	Lever lock clamping		C 
	M	Wedge/pin lock clamping		D 
	S	Screw-on clamping		R 
	C/J	Wedge clamping		S 
	D	Duel wedge clamping		T 
				V 
				L 
1	2		3	

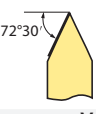
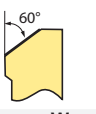
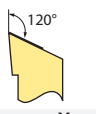
Tool holder type and entering angle					Clearance angle	
					B 	C 
A	B	C	D	E		
					D 	E 
F	G	H	J	K		
					N 	P 
L	M	N	O	P		
						
Q	R	S	T	U		
						
V	W	X				
4					5	

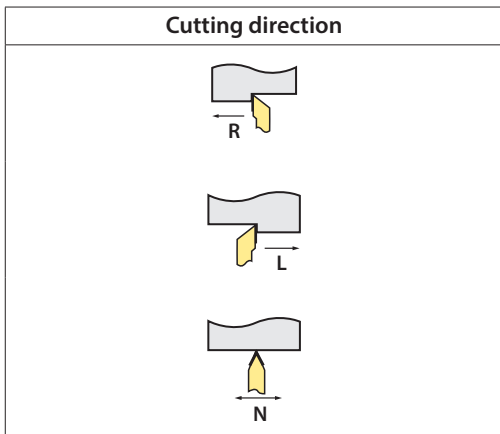

6

Cutting edge length l [mm]

I.C [mm]	Insert shape						
	C	D	R	S	T	V	W
5,56					09		
6,35	06	07			11		
9,525	09	11	09	09	16	16	06
12,7	12	15	12	12	22	22	08
15,875	16	19	15	15	27		
19,05	19		19	19	33		
25,4	25		25	25	44		
32			32				

7

A

Turning

B

Milling

C

Drilling

D

Technical Information

E

Index

A

LN** holder (external) P-Clamping

RW-PLANR/L Kr: 90°

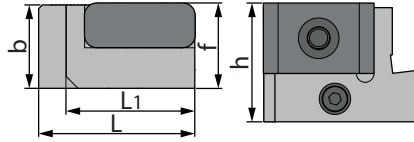
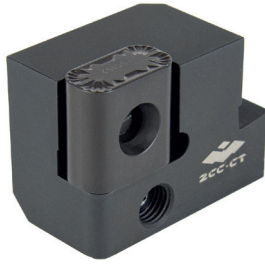

Right hand style

Turning

B

Article	*	Stock		Dimensions [mm]					Inserts
		R	L	b	L	h	L ₁	f	
RW-PLANR/L-19	*	○	○	22.5	43	32	35	23	LNUX1919**
RW-PLANR/L-30	*	○	○	22.5	43	32	35	23	LNUX3019**

● Ex stock ○ On demand

* With internal cooling

Milling

C

Spare parts

	Insert	LNUX1919**	LNUX3019**
	h	25-32	25-32
	Knee lever	L5 RWL	L5 RWL
	Screw	LEM8×25 RWL (10.2 Nm)	LEM8×25 RWL (10.2 Nm)
	Wrench	WH30L	WH30L

Drilling

D

Insert



Heavy Turning

A115

Technical Information

E

Index

System code > A314

Grade selection > A42

Technical info > A501

Cutting data > A366

LN** holder (external) P-Clamping

RW-PLFNR/L Kr: 90°



Right hand style

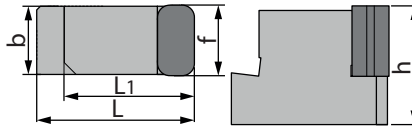



Article	*	Stock		Dimensions [mm]					Inserts
		R	L	b	L	h	L ₁	f	
RW-PLFNR/L-19	*	○	○	18.6	43	32	35	19.1	LNUX1919**

● Ex stock ○ On demand

* With internal cooling

Spare parts

	Insert	LNUX1919**
	h	25-32
	Knee lever	L5 RWL
	Screw	LEM8×25 RWL (10.2 Nm)
	Wrench	WH30L

Insert



Heavy Turning
A115

A

Turning

CN** holder (external) P-Clamping

RW-PCLNR/L Kr: 95°

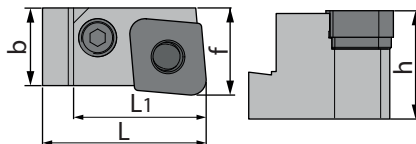

Right hand style

B

Milling

Article	*	Stock		Dimensions [mm]					Inserts
		R	L	b	L	h	L ₁	f	
RW-PCLNR/L-1907	*	○	○	24.8	43	32	35	19.1	CNMM1907**
RW-PCLNR/L-1911	*	○	○	24.8	43	32	35	19.1	CNMM1911**

● Ex stock ○ On demand

* With internal cooling

C

Drilling

Spare parts

	Insert	CNMM1907**	CNMM1911**
	h	25-32	25-32
	Knee lever	L5 RWC	L5 RWC
	Screw	LEM8×25 RWC (10.2 Nm)	LEM8×25 RWC (10.2 Nm)
	Shim pin (shim)	SP5 RWC	SP5 RWC
	Shim	C19 RWC	C19 RWC
	Wrench	WH30L	WH30L

D

Technical Information

Insert

Finishing	Roughing
A114	A114

E

Index











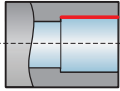
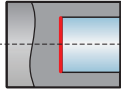
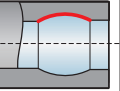
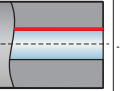
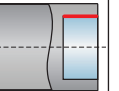







































System code > A314

Grade selection > A42

Technical info > A501











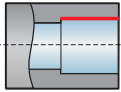
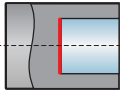
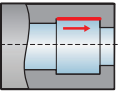
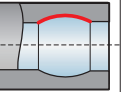
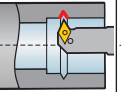
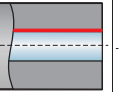
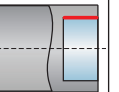

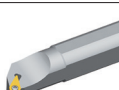

Cutting data > A366

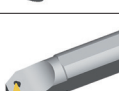
Boring bars

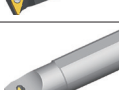
Boring bar	Application					Workpiece		Page	
	Longitudinal turning	Facing	Undercut	Contouring	Profiling	Stable	Unstable		
									
P	PDSNR/L 62°30'							A326	
	PCLNR/L 95°							A324	
	PDUNR/L 93°								A327
	PSKNR/L 75°								A329
	PTFNR/L 91°								A330
	PWLNR/L 95°								A332
S	SCFCR/L 90°								A352
	SCLCR/L 95°								A352
	SCLPR/L 95°								A354
	SDQCR/L 107°30'								A357
	SDQPR/L 107°30'								A356
	SDUCR/L 93°								A359
	SDUPR/L 93°								A358
	SDZCR/L 95°								A338

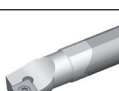
 Recommended

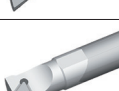
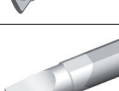
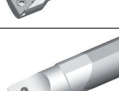
Boring bars

Boring bar	Application					Workpiece		Page
	Longitudinal turning	Facing	Undercut	Contouring	Profiling	Stable	Unstable	
								
S	SSKCR/L 75° 	<input type="checkbox"/>					<input checked="" type="checkbox"/>	A339
	STFCR/L 91° 	<input checked="" type="checkbox"/>						A361
	STUPR/L 93° 	<input checked="" type="checkbox"/>						A360
	SVQBR/L 107°30' 	<input checked="" type="checkbox"/>			<input checked="" type="checkbox"/>	<input checked="" type="checkbox"/>		A345
	SVXBR/L 93° 			<input checked="" type="checkbox"/>			<input checked="" type="checkbox"/>	A347
	SVQCR/L 107°30' 	<input checked="" type="checkbox"/>						A363
	SVUBR/L 93° 	<input checked="" type="checkbox"/>			<input checked="" type="checkbox"/>	<input checked="" type="checkbox"/>		A346
	SVUCR/L 93° 	<input checked="" type="checkbox"/>			<input checked="" type="checkbox"/>	<input checked="" type="checkbox"/>		A364
	SZLNR/L 95° 	<input checked="" type="checkbox"/>	<input checked="" type="checkbox"/>				<input checked="" type="checkbox"/>	A365
Antivibration	SCLPR/L 95° 	<input checked="" type="checkbox"/>	<input checked="" type="checkbox"/>					A348
	SDQPR/L 107°30' 	<input checked="" type="checkbox"/>			<input checked="" type="checkbox"/>	<input checked="" type="checkbox"/>		A349
	SDUPR/L 93° 	<input checked="" type="checkbox"/>						A350
	STUPR/L 93° 	<input checked="" type="checkbox"/>						A351
	SVQCR/L 107°30' 	<input checked="" type="checkbox"/>			<input checked="" type="checkbox"/>	<input checked="" type="checkbox"/>		A343
	SVUCR/L 93° 	<input checked="" type="checkbox"/>			<input checked="" type="checkbox"/>	<input checked="" type="checkbox"/>		A344

 Recommended

S 16 R – S D U C R 07 – KR93

1

2

3

4

5

6

7

8

9

10

A

Turning

B

Milling

C

Drilling

D

Technical Information

E

Index

Shank type

Code	Description
A	Steel shank (IC)
C	Solid carbide shank
E	Solid carbide shank (IC)
S	Steel shank
X	Special application

1

Shank diameter d [mm]

Code	d
16	16
20	20
25	25
32	32
40	40
50	50



2

Clamping system

Code	L
H	100
K	125
M	150
N	160
P	170
Q	180
R	200
S	250
T	300
U	350
V	400







3

Clamping system

Code	Description
P	Knee lever clamping 
S	Screw clamping 

4

Insert shape

C		D	
R		S	
T		V	
W			

5

Tool holder type and entering angle

6

Clearance angle

7

Cutting direction

8

Cutting edge length l [mm]

I.C [mm]	Insert shape						
	C	D	R	S	T	V	W
5,56	09						
6,35	06	07			11		
9,525	09	11	09	09	16	16	06
12,7	12	15	12	12	22	22	08
15,875	16	19	15	15	27		
19,05	19		19	19	33		
25,4	25		25	25	44		
32	32						

9

Entering angle

10

A

Turning

B

Milling

C

Drilling

D

Technical Information

E

Index

CN** steel boring bar P-Clamping

PCLNR/L Kr: 95°

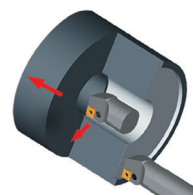
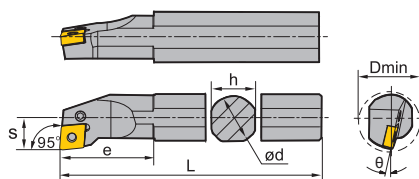
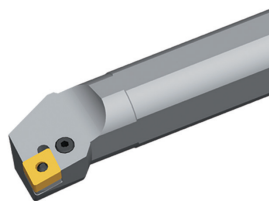

Right hand style









Article	*	Stock		Dimensions [mm]							Inserts
		R	L	ød	L	h	S	e	D _{min}	θ	
S16M-PCLNR/L09		●	●	16	150	15	11	28	20	-12	CN**0903**
S16R-PCLNR/L09		●	●	16	200	15	11	28	20	-12	CN**0903**
S20Q-PCLNR/L09		●	●	20	180	18	13	31	25	-11	CN**0903**
S20S-PCLNR/L09		●	●	20	250	18	13	31	25	-11	CN**0903**
S25Q-PCLNR/L09		○	○	25	180	23	17	35	32	-10	CN**0903**
S25T-PCLNR/L09		●	○	25	300	23	17	35	32	-10	CN**0903**
A16M-PCLNR/L09	*	○	○	16	150	14	11		20	-12	CN**0903**
S25Q-PCLNR/L12		○	○	25	180	23	17	40	32	-12	CN**1204**
S25T-PCLNR/L12		●	●	25	300	23	17	40	32	-12	CN**1204**
S32R-PCLNR/L12		●	●	32	200	30	22	50	44	-10	CN**1204**
S32U-PCLNR/L12		●	●	32	350	30	22	50	44	-10	CN**1204**
S40S-PCLNR/L12		○	●	40	250	37	27	55	54	-10	CN**1204**
S40V-PCLNR/L12		●	●	40	400	37	27	55	54	-10	CN**1204**
S50S-PCLNR/L12		○	○	50	250	47	35	56	63	-10	CN**1204**
S50W-PCLNR/L12		●	●	50	450	47	35	56	63	-10	CN**1204**
A25R-PCLNR/L12	*	●	●	25	200	24	17	40	32	-12	CN**1204**
A32S-PCLNR/L12	*	●	●	32	250	31	22	50	44	-10	CN**1204**
S50S-PCLNR/L19		○	○	50	250	47	35	63	63	-10	CN**1906**
S50W-PCLNR/L19		●	○	50	450	47	35	63	63	-10	CN**1906**

● Ex stock ○ On demand

* With internal cooling

CN steel boring bar**

Spare parts

	Insert ød	CN**0903** 16-25	CN**1204** 25	CN**1204** 32-50	CN**1906** 50
	Knee lever	L3C	L4A	L4A	L6
	Screw	LEM5×9B (4.0 Nm)			
	Screw				LEM10×27 (16.6 Nm)
	Screw		LEM6×13.4A (7.0 Nm)	LEM6×13.4A (7.0 Nm)	
	Shim pin (shim)			SP4	SP6
	Shim				C19AP
	Shim			C12APB	
	Wrench		WH25L	WH25L	WH40L
	Wrench	WT09IP			

Insert

					
Wiper	Finishing	Medium Cut	Roughing	Cast Iron	PCBN/PCD
A51	A52	A53	A57	A61	A177

System code > A322

Grade selection > A42

Technical info > A501

Cutting data > A366

DN** steel boring bar P-Clamping

PDSNR/L Kr: 62°30'

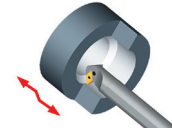
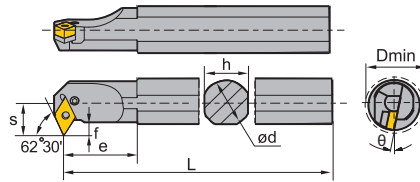
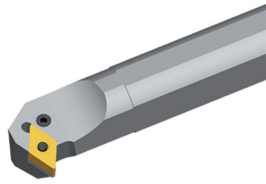

Right hand style

Article	*	Stock		Dimensions [mm]								Inserts
		R	L	ød	L	h	s	e	f	D _{min}	θ	
S32R-PDSNR/L15-3		○	○	32	200	30	22	45	8.5	40	-11	DN**1504**
S40V-PDSNR/L15-3		●		40	400	37	27	43	9.4	50	-11	DN**1504**
A32S-PDSNR/L15-3	*	○	○	32	250	31	22	45	8.5	40	-11	DN**1504**
S32R-PDSNR/L15		●	●	32	200	30	22	45	8.5	40	-11	DN**1506**
S32U-PDSNR/L15		●	●	32	350	30	22	45	8.5	40	-11	DN**1506**
S40S-PDSNR/L15		○	○	40	250	37	27	43	9.4	50	-11	DN**1506**
S40V-PDSNR/L15		○	○	40	400	37	27	43	9.4	50	-11	DN**1506**
A32S-PDSNR/L15	*	●	●	32	250	31	22	45	8.5	40	-11	DN**1506**

● Ex stock ○ On demand

* With internal cooling

Spare parts

	Insert ød	DN**1504**	DN**1506**
		32-40	32-40
	Knee lever	L4	L4B
	Screw	LEM8×21 (10.2 Nm)	LEM8×21 (10.2 Nm)
	Shim pin (shim)	SP4	SP4
	Shim	D15AP	D15AP
	Wrench	WH30L	WH30L

Insert

Wiper A62	Finishing A63	Medium Cut A63	Roughing A68	Cast Iron A69	PCBN/PCD A178

System code > A322

Grade selection > A42

Technical info > A501

Cutting data > A366

DN steel boring bar P-Clamping**

PDUNR/L Kr: 93°

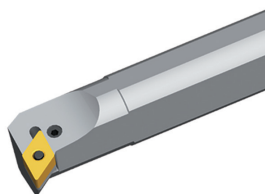

Right hand style

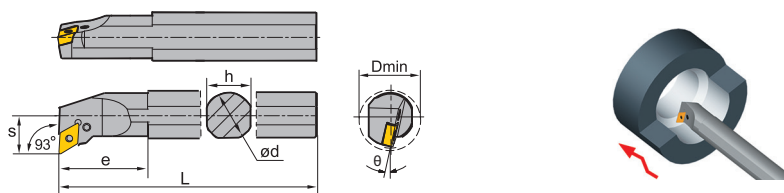

Article	*	Stock		Dimensions [mm]							Inserts
		R	L	ød	L	h	s	e	D _{min}	θ	
S20Q-PDUNR/L11	● ○	20	180	18	13	30	25	-16	DN**1104**		
S20S-PDUNR/L11	● ●	20	250	18	13	30	25	-16	DN**1104**		
S25Q-PDUNR/L11	● ●	25	180	23	17	35	32	-13	DN**1104**		
S25T-PDUNR/L11	● ●	25	300	23	17	35	32	-13	DN**1104**		
S32R-PDUNR/L11	○ ○	32	200	30	22	40	40	-16	DN**1104**		
S32U-PDUNR/L11	● ●	32	350	30	22	40	40	-16	DN**1104**		
A25R-PDUNR/L11	* ●	25	200	24	17	35	32	-13	DN**1104**		
S32R-PDUNR/L15-3	○ ○	32	200	30	22	50	40	-16	DN**1504**		
S32U-PDUNR/L15-3	● ●	32	350	30	22	50	40	-16	DN**1504**		
S40S-PDUNR/L15-3	○ ○	40	250	37	27	50	50	-11	DN**1504**		
S40V-PDUNR/L15-3	● ●	40	400	37	27	50	50	-11	DN**1504**		
A32S-PDUNR/L15-3	* ● ●	32	250	31	22	50	40	-16	DN**1504**		
S32R-PDUNR/L15	○ ○	32	200	30	22	50	40	-16	DN**1506**		
S32U-PDUNR/L15	● ●	32	350	30	22	50	40	-16	DN**1506**		
S40S-PDUNR/L15	○ ○	40	250	37	27	50	50	-11	DN**1506**		
S40V-PDUNR/L15	● ●	40	400	37	27	50	50	-11	DN**1506**		
A32S-PDUNR/L15	* ● ●	32	250	31	22	50	40	-16	DN**1506**		

● Ex stock ○ On demand

* With internal cooling

Spare parts

	Insert ød	DN**1104** 20-25	DN**1104** 32	DN**1504** 32-40	DN**1506** 32-40
	Knee lever	L3D	L3	L4	L4B
	Screw	LEM5×12B (4.0 Nm)	LEM6×17 (7.0 Nm)		
	Screw			LEM8×21 (10.2 Nm)	LEM8×21 (10.2 Nm)
	Shim pin (shim)		SP3	SP4	SP4
	Shim		D11AP	D15AP	D15AP
	Wrench		WH25L	WH30L	WH30L
	Wrench	WT09IP			

System code > A322

Grade selection > A42

Technical info > A501

Cutting data > A366



A

Turning

B

Milling

C

Drilling

D

Technical Information

E

Index

A

DN** steel boring bar

Insert



Wiper

A62



Finishing

A63



Medium Cut

A63



Roughing

A68



Cast Iron

A69



PCBN/PCD

A178

Turning

B

Milling

C

Drilling

D

Technical
Information

E

Index

System code > A322

Grade selection > A42

Technical info > A501

Cutting data > A366

SN** steel boring bar **P-Clamping**

PSKNR/L Kr: 75°

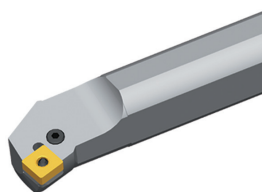

Right hand style

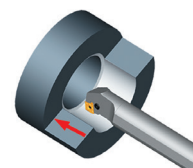
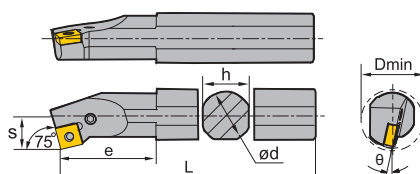

Article	*	Stock		Dimensions [mm]							Inserts
		R	L	ød	L	h	s	e	D _{min}	θ	
S25Q-PSKNR/L12		○	●	25	180	23	17	42	32	-12	SN**1204**
S25T-PSKNR/L12		●	○	25	300	23	17	42	32	-12	SN**1204**
S32R-PSKNR/L12		○	○	32	200	30	22	45	44	-10	SN**1204**
S32U-PSKNR/L12		●	●	32	350	30	22	45	44	-10	SN**1204**
S40S-PSKNR/L12		○	○	40	250	37	27	50	54	-10	SN**1204**
S40V-PSKNR/L12		●	○	40	400	37	27	50	54	-10	SN**1204**
A25R-PSKNR/L12	*	●	●	25	200	24	17	42	32	-12	SN**1204**
A32S-PSKNR/L12	*	●	●	32	250	31	22	50	44	-12	SN**1204**

● Ex stock ○ On demand

* With internal cooling

Spare parts			
	Insert ød	SN**1204**	SN**1204**
		25	32-40
	Knee lever	L4A	L4
	Screw		LEM8×21 (10.2 Nm)
	Screw	LEM6×13.4A (7.0 Nm)	
	Shim pin (shim)		SP4
	Shim		S12APB
	Wrench	WH25L	WH30L

Insert				
Finishing A73	Medium Cut A73	Roughing A78	Cast Iron A84	PCBN/PCD A162

System code > A322

Grade selection > A42

Technical info > A501

Cutting data > A366

TN** steel boring bar P-Clamping

PTFNR/L Kr: 90°

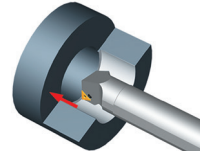
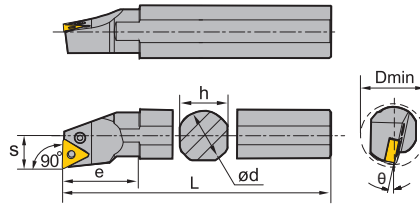
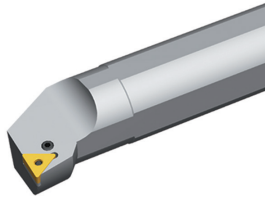

Right hand style

Article	*	Stock		Dimensions [mm]							Inserts
		R	L	ød	L	h	s	e	D _{min}	θ	
S16M-PTFNR/L11	○	○	16	150	15	11	28	20	-14	TN**1103**	
S16R-PTFNR/L11	●	●	16	200	15	11	28	20	-14	TN**1103**	
S20Q-PTFNR/L11	●	●	20	180	18	13	31	25	-12	TN**1103**	
S20S-PTFNR/L11	●	●	20	250	18	13	31	25	-12	TN**1103**	
S25Q-PTFNR/L11	○	○	25	180	23	17	35	32	-10	TN**1103**	
S25T-PTFNR/L11	○	○	25	300	23	17	35	32	-10	TN**1103**	
S25Q-PTFNR/L16	○	○	25	180	23	17	42	32	-12	TN**1604**	
S25T-PTFNR/L16	●	●	25	300	23	17	42	32	-12	TN**1604**	
S32R-PTFNR/L16	○	○	32	200	30	22	50	44	-10	TN**1604**	
S32U-PTFNR/L16	●	●	32	350	30	22	50	44	-10	TN**1604**	
S40S-PTFNR/L16	○	○	40	250	37	27	55	54	-10	TN**1604**	
S40V-PTFNR/L16	●	●	40	400	37	27	55	54	-10	TN**1604**	
A25R-PTFNR/L16	*	○	25	200	24	17	40	32	-12	TN**1604**	
A32S-PTFNR/L16	*	●	32	250	31	22	50	44	-10	TN**1604**	

● Ex stock ○ On demand

* With internal cooling

Spare parts

Insert	ød	TN**1103**	TN**1604**	TN**1604**
		16-25	25	32-40
Knee lever		L2	L3B	L3
Screw		LEM5×9B (4.0 Nm)	LEM5×12B (4.0 Nm)	LEM6×17 (7.0 Nm)
Shim pin (shim)				SP3
Shim				T16APB
Wrench			WH20L	WH25L
Wrench		WT09IP		







System code > A322

Grade selection > A42

Technical info > A501

Cutting data > A366

TN steel boring bar**

Insert					
					
Wiper	Finishing	Medium Cut	Roughing	Cast Iron	PCBN/PCD
A87	A88	A90	A92	A99	A163

A

Turning

B

Milling

C

Drilling

D

Technical Information

E

Index

System code > A322

Grade selection > A42

Technical info > A501

Cutting data > A366



WN** steel boring bar P-Clamping

PWLNR/L Kr: 95°

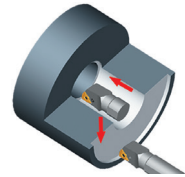
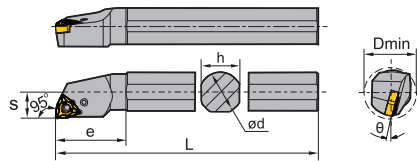
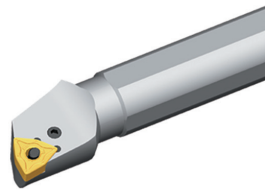

Right hand style

Article	*	Stock		Dimensions [mm]							Inserts
		R	L	ød	L	h	s	e	D _{min}	θ	
S16M-PWLNR/L06	●	●	16	150	15	11	25	20	-13	WN**0604**	
S16M-PWLNR/L06	●	○	16	150	15	11	25	20	-13	WN**0604**	
S16R-PWLNR/L06	○	○	16	200	15	11	25	20	-13	WN**0604**	
S20Q-PWLNR/L06	●	●	20	180	18	13	35	25	-13	WN**0604**	
S20S-PWLNR/L06	●	○	20	250	18	13	35	25	-13	WN**0604**	
S25Q-PWLNR/L06	○	○	25	180	23	17	35	32	-13	WN**0604**	
S25T-PWLNR/L06	○	○	25	300	23	17	35	32	-13	WN**0604**	
S20Q-PWLNR/L08	●	●	20	180	18	13	32	25	-13	WN**0804**	
S20S-PWLNR/L08	●	○	20	250	18	13	32	25	-13	WN**0804**	
S25Q-PWLNR/L08	●	○	25	180	23	17	45	32	-13	WN**0804**	
S25T-PWLNR/L08	●	●	25	300	23	17	45	32	-13	WN**0804**	
S32R-PWLNR/L08	●	●	32	200	30	22	50	40	-15	WN**0804**	
S32U-PWLNR/L08	●	●	32	350	30	22	50	40	-15	WN**0804**	
S50W-PWLNR/L08	○	○	50	450	47	35	50	63	-15	WN**0804**	

● Ex stock ○ On demand

* With internal cooling

Spare parts

	Insert	WN**0604**	WN**0804**	WN**0804**	WN**0804**
		ød	16-25	20-25	32
	Knee lever	L3B	L4A	L4	L4
	Screw	LEM5×12B (4.0 Nm)		LEM8×21 (10.2 Nm)	LEM8×21 (10.2 Nm)
	Screw		LEM6×13.4A (7.0 Nm)		
	Screw				
	Shim pin (shim)			SP4	SP4
	Shim			W08AP	W08AP
	Wrench		WH25L	WH30L	WH30L
	Wrench	WT09IP			

System code > A322

Grade selection > A42

Technical info > A501

Cutting data > A366

WN steel boring bar**

Insert					
					
Wiper	Finishing	Medium Cut	Roughing	Cast Iron	PCBN/PCD
A106	A107	A107	A109	A111	A165

A

Turning

B

Milling

C

Drilling

D

Technical Information

E

Index

System code > A322

Grade selection > A42

Technical info > A501

Cutting data > A366



CC** steel boring bar S-Clamping

SCLCR/L Kr: 95°

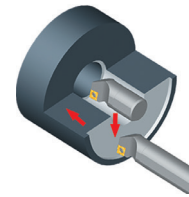
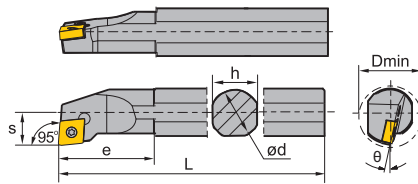
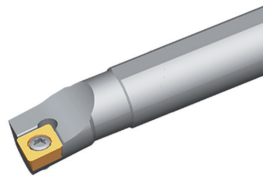

Right hand style

Article	*	Stock		Dimensions [mm]								Inserts
		R	L	ød	L	h	s	L ₂	e	D _{min}	θ	
S08K-SCLCR/L06		●	●	8	125	7	5	14	14	10	-15	CC**0602**
S10K-SCLCR/L06		●	●	10	125	7	5	14	14	10	-15	CC**0602**
S10M-SCLCR/L06		●	●	10	150	9	6	14	14	12	-13	CC**0602**
S12M-SCLCR/L06		●	●	12	150	11	9	25	25	16	-10	CC**0602**
A08F-SCLCR/L06	*	●	●	8	80	7.5	5	14	14	10	-15	CC**0602**
A10H-SCLCR/L06	*	●	●	10	100	9.5	6	14	14	12	-13	CC**0602**
A12K-SCLCR/L06	*	●	●	12	125	11.5	9	25	25	16	-10	CC**0602**
S12M-SCLCR/L09		●	●	12	150	11	9	25	25	16	-10	CC**09T3**
S16M-SCLCR/L09		●	○	16	150	15	11	32.5	32.5	20	-12	CC**09T3**
S16R-SCLCR/L09		●	●	16	200	15	11	32.5	32.5	20	-12	CC**09T3**
S20Q-SCLCR/L09		●	●	20	180	18	13	38	38	25	-8	CC**09T3**
S20S-SCLCR/L09		●	●	20	250	18	13	38	38	25	-8	CC**09T3**
S25Q-SCLCR/L09		●	○	25	180	23	17	45	45	32	-6	CC**09T3**
S25T-SCLCR/L09		●	●	25	300	23	17	45	45	32	-6	CC**09T3**
A12K-SCLCR/L09	*	●	●	12	125	11.5	9	25	25	16	-10	CC**09T3**
A16M-SCLCR/L09	*	●	●	16	150	15.5	11	32.5	32.5	20	-12	CC**09T3**
A20Q-SCLCR/L09	*	●	●	20	180	19	13	38	38	25	-8	CC**09T3**
A25R-SCLCR/L09	*	●	●	25	200	24	17	45	45	32	-6	CC**09T3**
S25Q-SCLCR/L12		●	○	25	180	23	17	45	45	32	-6	CC**1204**
S25T-SCLCR/L12		●	●	25	300	23	17	45	45	32	-6	CC**1204**
S32R-SCLCR/L12		●	●	32	200	30	22	50	50	40	-10	CC**1204**
S32U-SCLCR/L12		●	●	32	350	30	22	50	50	40	-10	CC**1204**
S40S-SCLCR/L12		○		40	250	37	27	60	60	50	-8	CC**1204**
S40V-SCLCR/L12		●	●	40	400	37	27	60	60	50	-8	CC**1204**
A25R-SCLCR/L12	*	●	●	25	200	24	17	45	45	32	-6	CC**1204**
A32T-SCLCR/L12	*	○		32	300	30	22			40	-10	CC**1204**
A32S-SCLCR/L12	*	●	●	32	250	31	22	50	50	40	-10	CC**1204**

● Ex stock ○ On demand

* With internal cooling

System code > A322







Grade selection > A42

Technical info > A501







Cutting data > A366

CC steel boring bar**

Spare parts

	Insert ød	CC**0602** 8-12	CC**09T3** 12-20	CC**09T3** 25	CC**1204** 25	CC**1204** 32-40
	Screw	I60M2.5×5.5 (1.0 Nm)	I60M3.5×8 (2.7 Nm)	I60M3.5×10 (2.7 Nm)		
	Screw				I60M4×11X (3.4 Nm)	I60M4×11X (3.4 Nm)
	Screw (shim)					SM6×10XA
	Shim					C12B5
	Wrench (screw)	WT07IP	WT15IP	WT15IP	WT15IP	WT15IP
	Wrench (shim)					WH40L

Insert

					
Finishing	Medium Cut	Roughing	Alum Machining	Cast Iron	PCBN/PCD
A116	A119	A121	A122	A121	A180

A

Turning

B

Milling

C

Drilling

D

Technical
Information

E

Index

System code > A322

Grade selection > A42

Technical info > A501

Cutting data > A366

General turning Boring bars

DC** steel boring bar **S-Clamping**

SDQCR/L Kr: 107°30'

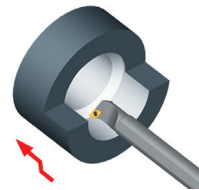
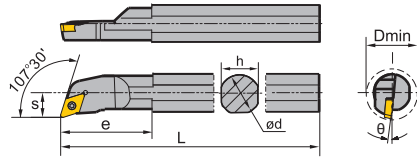
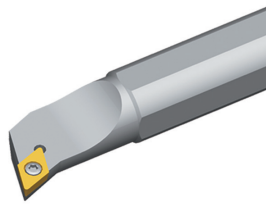

Right hand style

Article	*	Stock		Dimensions [mm]								Inserts
		R	L	ød	L	h	s	L ₂	e	D _{min}	θ	
S10M-SDQCR/L07	•	•	10	150	9	7	20	20	13	-8	DC**0702**	
S12M-SDQCR/L07	•	•	12	150	11	9	22	22	16	-8	DC**0702**	
S16M-SDQCR/L07	○	•	16	150	15	11	27	27	20	-6	DC**0702**	
S16Q-SDQCR/L07	•	•	16	180	15	11	27	27	20	-6	DC**0702**	
S16R-SDQCR/L07	•	•	16	200	15	11	27	27	20	-6	DC**0702**	
A10H-SDQCR/L07	*	•	•	10	100	9.5	7	20	20	13	-8	DC**0702**
A12K-SDQCR/L07	*	•	•	12	125	11.5	9	22	22	16	-8	DC**0702**
S20Q-SDQCR/L11	•	○	20	180	18	13	32	32	25	-6	DC**11T3**	
S20S-SDQCR/L11	•	•	20	250	18	13	32	32	25	-6	DC**11T3**	
S25Q-SDQCR/L11	•	○	25	180	23	17	32	32	32	-6	DC**11T3**	
S25T-SDQCR/L11	•	•	25	300	23	17	32	32	32	-6	DC**11T3**	
A16M-SDQCR/L11	*	•	•	16	150	15.5	11	27	27	20	-6	DC**11T3**
A20Q-SDQCR/L11	*	•	•	20	180	19	13	32	32	25	-6	DC**11T3**
A25R-SDQCR/L11	*	•	•	25	200	24	17	32	32	32	-6	DC**11T3**

• Ex stock ○ On demand

* With internal cooling

Spare parts

Insert	ød	DC**0702**	DC**0702**	DC**11T3**	DC**11T3**	DC**11T3**
		10	12-16	16-20	20	25
Screw		I60M2.5×5.5 (1.0 Nm)	I60M2.5×6.5 (1.0 Nm)	I60M3.5×8 (2.7 Nm)	I60M3.5×8 (2.7 Nm)	I60M3.5×10 (2.7 Nm)
Wrench (screw)		WT07IP	WT07IP	WT15IP	WT15IP	WT15IP

Insert

Finishing A126	Medium Cut A127	Roughing A129	Alum Machining A129	Cast Iron A129	PCBN/PCD A184

System code > A322

Grade selection > A42

Technical info > A501

Cutting data > A366

DC steel boring bar S-Clamping**

SDUCR/L Kr: 93°

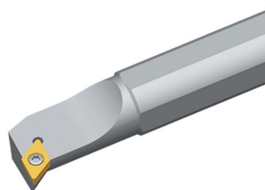

Right hand style

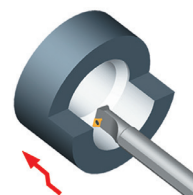
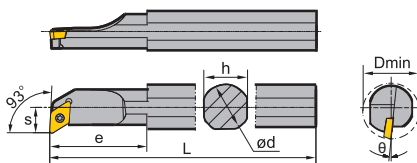

Article	*	Stock		Dimensions [mm]								Inserts
		R	L	ød	L	h	s	L ₂	e	D _{min}	θ	
S10M-SDUCR/L07	●	●	10	150	9	7	-	0	13	-8	DC**0702**	
S12M-SDUCR/L07	●	●	12	150	11	9	22	22	16	-8	DC**0702**	
S16M-SDUCR/L07	●	●	16	150	15	11	27	27	20	-6	DC**0702**	
S16R-SDUCR/L07	●	●	16	200	15	11	27	27	20	-6	DC**0702**	
A10H-SDUCR/L07	*	●	10	100	9.5	7	-	0	13	-8	DC**0702**	
A12K-SDUCR/L07	*	●	12	125	11.5	9	22	22	16	-8	DC**0702**	
A16M-SDUCR/L07	*	●	16	150	15.5	11	27	27	20	-6	DC**0702**	
S20Q-SDUCR/L11	●	●	20	180	18	13	40	40	25	-6	DC**11T3**	
S20S-SDUCR/L11	●	●	20	250	18	13	40	40	25	-6	DC**11T3**	
S25Q-SDUCR/L11	●	○	25	180	23	17	46	46	32	-6	DC**11T3**	
S25T-SDUCR/L11	●	●	25	300	23	17	46	46	32	-6	DC**11T3**	
A16R-SDUCR/L11	*	○	16	200	15	14.5	27	27	23	-6	DC**11T3**	
A20Q-SDUCR/L11	*	●	20	180	19	13	40	40	25	-6	DC**11T3**	
A25R-SDUCR/L11	*	●	25	200	24	17	46	46	32	-6	DC**11T3**	

● Ex stock ○ On demand

* With internal cooling

Spare parts			
	Insert	DC**0702**	DC**11T3**
	ød	10-16	16-25
	Screw	I60M2.5x5.5 (1.0 Nm)	I60M3.5x8 (2.7 Nm)
	Wrench	WT07IP	WT15IP

Insert					
Finishing A126	Medium Cut A127	Roughing A129	Alum Machining A129	Cast Iron A129	PCBN/PCD A184

DC** steel boring bar S-Clamping

SDZCR/L Kr: 85°

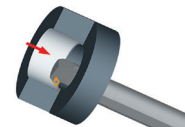
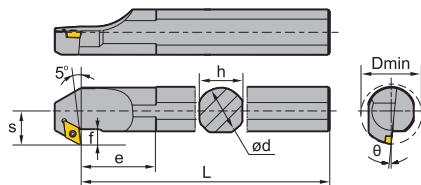
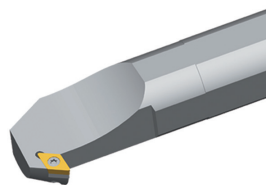

Right hand style

Article	*	Stock		Dimensions [mm]								Inserts
		R	L	ød	L	h	s	e	f	D _{min}	θ	
S25Q-SDZCR/L11		●	●	25	180	23	17	30	6.9	32	-6	DC**11T3**
S25T-SDZCR/L11		●	●	25	300	23	17	30	6.9	32	-6	DC**11T3**
S32R-SDZCR/L11		○		32	200	30	22	39	8.4	40	-6	DC**11T3**
S32U-SDZCR/L11		●	●	32	350	30	22	39	8.4	40	-6	DC**11T3**
S40S-SDZCR/L11		○	●	40	250	37	27	47	9.4	50	-4	DC**11T3**
S40V-SDZCR/L11		●	●	40	400	37	27	47	9.4	50	-4	DC**11T3**
A25R-SDZCR/L11	*	●	●	25	200	24	17	30	4.5	32	-6	DC**11T3**
A32S-SDZCR/L11	*	●	●	32	250	31	22	39	6	40	-6	DC**11T3**

● Ex stock ○ On demand

* With internal cooling

Spare parts

	Insert ød	DC**11T3**	
		25	32-40
Screw		I60M3.5x10 (2.7 Nm)	I60M3.5x12 (2.7 Nm)
Screw (shim)			SM5x8.65XA
Shim			D11BS
Wrench (screw)		WT15IP	WT15IP
Wrench (shim)			WH35L

Insert

Finishing A126	Medium Cut A127	Roughing A129	Alum Machining A129	Cast Iron A129	PCBN/PCD A184

SC steel boring bar S-Clamping**

SSKCR/L Kr: 75°

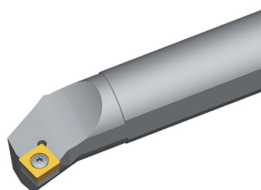

Right hand style

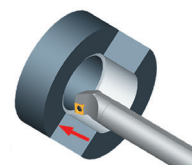
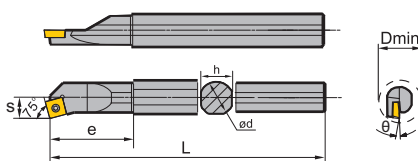

Article	*	Stock		Dimensions [mm]							Inserts
		R	L	ød	L	h	s	e	D _{min}	θ	
S12M-SSKCR/L09	●	●	12	150	11	9	26	16	-10	SC**09T3**	
S16M-SSKCR/L09	○	○	16	150	15	11	32.5	20	-11	SC**09T3**	
S16R-SSKCR/L09	○	○	16	200	15	11	32.5	20	-11	SC**09T3**	
S20Q-SSKCR/L09	○	○	20	180	18	13	34.5	25	-6	SC**09T3**	
S20S-SSKCR/L09	●	○	20	250	18	13	34.5	25	-6	SC**09T3**	
A12K-SSKCR/L09	*	●	○	12	125	11	9	26	-10	SC**09T3**	
A16M-SSKCR/L09	*	●	○	16	150	15	11	32.5	-11	SC**09T3**	
A20Q-SSKCR/L09	*	●	○	20	180	19	13	34.5	-6	SC**09T3**	
S25Q-SSKCR/L12	○	○	25	180	23	17	36.3	32	-8	SC**1204**	
S25T-SSKCR/L12	●	○	25	300	23	17	36.3	32	-8	SC**1204**	
S32R-SSKCR/L12	○	○	32	200	30	22	43.5	40	-10	SC**1204**	
S32U-SSKCR/L12	●	○	32	350	30	22	43.5	40	-10	SC**1204**	
A25R-SSKCR/L12	*	●	○	25	200	24	17	41.3	-8	SC**1204**	
A32S-SSKCR/L12	*	●	○	32	250	31	22	42.8	-10	SC**1204**	

● Ex stock ○ On demand

* With internal cooling

Spare parts

	Insert ød	SC**09T3**	SC**1204**	SC**1204**
		12-20	25	32
	Screw	I60M3.5x8 (2.7 Nm)		
	Screw		I60M4x11X (3.4 Nm)	I60M4x11X (3.4 Nm)
	Screw (shim)			SM6x10XA
	Shim			S12BS
	Wrench (screw)	WT15IP	WT15IP	WT15IP
	Wrench (shim)			WH40L

System code > A322

Grade selection > A42

Technical info > A501

Cutting data > A366



A

Turning

B

Milling

C

Drilling

D

Technical Information





E

Index

A

Turning

SC** steel boring bar

Insert			
			
Finishing	Medium Cut	Roughing	Alum Machining
A134	A135	A136	A136

B

Milling

C

Drilling

D

Technical Information

E

Index

System code > A322

Grade selection > A42

Technical info > A501

Cutting data > A366

TC steel boring bar S-Clamping**

STFCR/L Kr: 91°

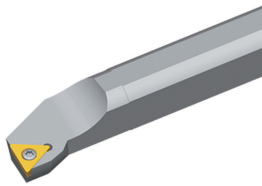

Right hand style

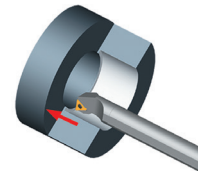
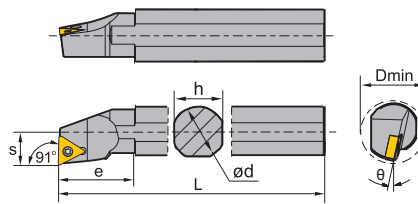

Article	*	Stock		Dimensions [mm]							Inserts
		R	L	ød	L	h	s	e	D _{min}	θ	
S12M-STFCR/L11		●	●	12	150	11	9	30	16	-10	TC**1102**
S16M-STFCR/L11		○	●	16	150	15	11	35	20	-6	TC**1102**
S16R-STFCR/L11		●	●	16	200	15	11	35	20	-6	TC**1102**
S20Q-STFCR/L11		○	○	20	180	18	13	36	25	-3	TC**1102**
S20S-STFCR/L11		●	●	20	250	18	13	36	25	-3	TC**1102**
A12K-STFCR/L11	*	●	●	12	125	11.5	9	26	16	-10	TC**1102**
A16M-STFCR/L11	*	●	●	16	150	15.5	11	30	20	-6	TC**1102**
A20Q-STFCR/L11	*	●	●	20	180	19	13	36	25	-3	TC**1102**
S25Q-STFCR/L16		●	○	25	180	23	17	49	32	-6	TC**16T3**
S25T-STFCR/L16		●	●	25	300	23	17	49	32	-6	TC**16T3**
S32R-STFCR/L16		●	●	32	200	30	22	50	40	-10	TC**16T3**
S32U-STFCR/L16		●	●	32	350	30	22	50	40	-10	TC**16T3**
S40S-STFCR/L16		○	○	40	250	37	27	60	50	-8	TC**16T3**
S40V-STFCR/L16		●	●	40	400	37	27	60	50	-8	TC**16T3**
A25R-STFCR/L16	*	●	●	25	200	24	17	45	32	-6	TC**16T3**
A32S-STFCR/L16	*	●	○	32	250	31	22	49	40	-10	TC**16T3**

● Ex stock ○ On demand

* With internal cooling







Spare parts

	Insert ød	TC**1102**	TC**16T3**	TC**16T3**
		12-20	25	32-40
Screw		I60M2.5×6.5 (1.0 Nm)	I60M3.5×10 (2.7 Nm)	I60M3.5×12 (2.7 Nm)
Screw (shim)				SM5×8.65XA
Shim				T16BS
Wrench (screw)		WT07IP	WT15IP	WT15IP
Wrench (shim)				WH35L

A

Turning

TC** steel boring bar

Insert					
					
Finishing	Medium Cut	Roughing	Alum Machining	Cast Iron	PCBN/PCD
A141	A142	A143	A145	A143	A187

B

Milling

C

Drilling

D

Technical Information

E

Index

System code > A322

Grade selection > A42

Technical info > A501

Cutting data > A366

VC steel boring bar S-Clamping**

SVQCR/L Kr: 107°30'

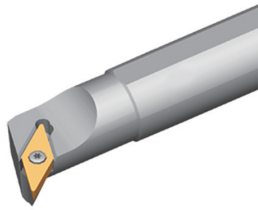

Right hand style

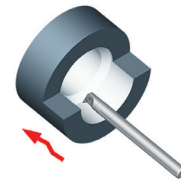
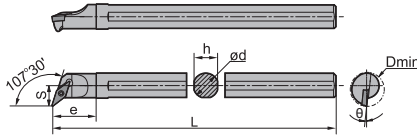



Article	*	Stock		Dimensions [mm]						Inserts
		R	L	ød	L	h	s	e	D _{min}	θ
S16Q-SVQCR/L11	●	●	16	180	15	13	28	22	-6	VC**1103**
S20R-SVQCR/L11	●	○	20	200	18	15	32	26	-4	VC**1103**

● Ex stock ○ On demand

* With internal cooling

Spare parts

	Insert	VC**1103**
	ød	16-20
	Screw	I60M2.5×6.5 (1.0 Nm)
	Wrench (screw)	WT07IP

Insert

Finishing	Alum Machining	PCBN/PCD
		
A156	A154	A193

System code > A322

Grade selection > A42

Technical info > A501

Cutting data > A366

VC** steel boring bar S-Clamping

SVUCR/L Kr: 93°

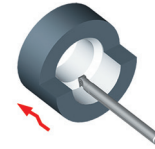
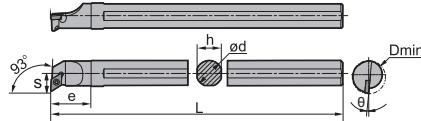
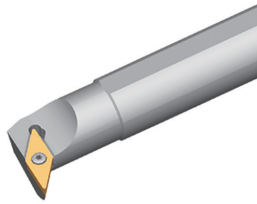

Right hand style

Article	*	Stock		Dimensions [mm]								Inserts
		R	L	ød	L	h	s	L ₂	e	D _{min}	θ	
S16Q-SVUCR/L11	● ○	16	180	15	15	25	25	24	-6	VC**1103**		
S20R-SVUCR/L11	● ●	20	200	18	17	30	30	28	-4	VC**1103**		
S40U-SVUCR/L16	○	40	350	37	27	56	56	50	-8	VC**1604**		

● Ex stock ○ On demand

* With internal cooling

Spare parts

	Insert	VC**1103**	VC**1604**
	ød	16-20	40
	Screw	I60M2.5×6.5 (1.0 Nm)	I60M3.5×12 (2.7 Nm)
	Screw (shim)		SM5×8.65XA (4.0 Nm)
	Shim		V16BSC
	Wrench (screw)	WT07IP	WT15IP
	Wrench (shim)		WH35L

Insert

Finishing	Medium Cut	Alum Machining	PCBN/PCD
A156	A156	A154	A193

VB steel boring bar S-Clamping**

SVQBR/L Kr: 107°30'

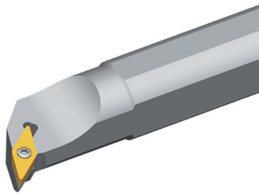

Right hand style

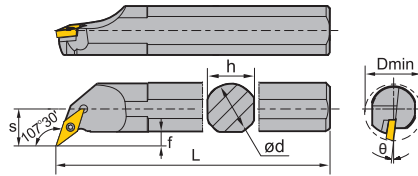

Article	*	Stock		Dimensions [mm]								Inserts
		R	L	ød	L	h	s	e	f	D _{min}	θ	
S32R-SVQBR/L16	●	●	32	200	30	22	56	8.4	40	-8	VB**1604**	
S32U-SVQBR/L16	●	●	32	350	30	22	56	8.4	40	-8	VB**1604**	
S40V-SVQBR/L16	●	●	40	400	37	27	64	9.4	50	-8	VB**1604**	
A32S-SVQBR/L16	* ○	○	32	250	31	22	56	8.4	40	-8	VB**1604**	

● Ex stock ○ On demand

* With internal cooling

Spare parts

	Insert ød	VB**1604** 32-40
	Screw	I60M3.5×12 (2.7 Nm)
	Screw (shim)	SM5×8.65XA
	Shim	V16BS
	Wrench (screw)	WT15IP
	Wrench (shim)	WH35L

Insert

Finishing A148	Medium Cut A151	Roughing A152	PCBN/PCD A191

System code > A322

Grade selection > A42

Technical info > A501

Cutting data > A366

VB** steel boring bar S-Clamping

SVUBR/L Kr: 93°

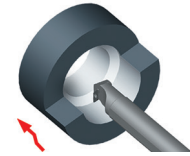
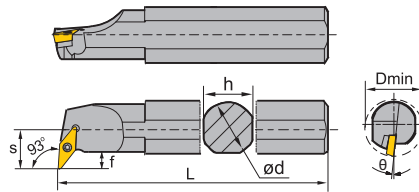
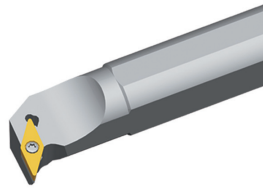

Right hand style

Article	*	Stock		Dimensions [mm]								Inserts
		R	L	ød	L	h	s	e	f	D _{min}	θ	
S32R-SVUBR/L16		●	○	32	200	30	22	49	8.4	40	-8	VB**1604**
S32U-SVUBR/L16		●	●	32	350	30	22	49	8.4	40	-8	VB**1604**
S40S-SVUBR/L16		●	○	40	250	37	27	56.5	9.4	50	-8	VB**1604**
S40V-SVUBR/L16		●	●	40	400	37	27	56.5	9.4	50	-8	VB**1604**
A32S-SVUBR/L16	*	●	●	32	250	31	22	49	8.4	40	-8	VB**1604**

● Ex stock ○ On demand

* With internal cooling

Spare parts

	Insert ød	VB**1604** 32-40
	Screw	I60M3.5×12 (2.7 Nm)
	Screw (shim)	SM5×8.65XA
	Shim	V16BS
	Wrench (screw)	WT15IP
	Wrench (shim)	WH35L

Insert

Finishing A148	Medium Cut A151	Roughing A152	PCBN/PCD A191

System code > A322

Grade selection > A42

Technical info > A501

Cutting data > A366

VB steel boring bar S-Clamping**

SVXBR/L Kr: 93°

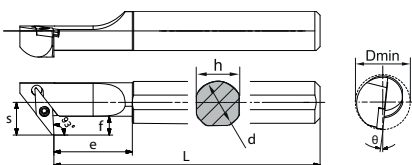
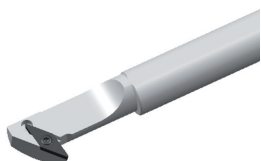

Right hand style

Article	Stock		Dimensions [mm]								Inserts
	R	L	ød	L	h	s	e	f	D _{min}	θ	
S16P-SVXBR/L1102-KR93	○	○	16	170	15	12.5	30	72	21	-8	VB**1102**
S16P-SVXBR/L11-KR93	○	○	16	170	15	12.5	30	72	21	-8	VB**1103**
S20R-SVXBR/L11-KR93	○	○	20	187	20	13	22	5.7	25	-8	VB**1103**
S25S-SVXBR/L16-KR93	○	○	25	235	25	19	26	10.2	32	-8	VB**1604**
S32T-SVXBR/L16-KR93	○	○	32	280	32	22	80	11.7	40	-8	VB**1604**
S40M-SVXBR/L16-KR93	○	○	40	130	40	27	40	14.3	50	-8	VB**1604**
S40U-SVXBR/L16-KR93	○	○	40	330	40	27	90	14.3	50	-8	VB**1604**

- Ex stock ○ On demand
- * With internal cooling

Spare parts

	Insert ød	VB**1102**	VB**1103**	VB**1604**
		16-20	16-20	25-40
	Screw	I60M2.5x6.5 (1.0 Nm)	I60M2.5x6.5 (1.0 Nm)	I60M3.5x12 (2.7 Nm)
	Screw (shim)			SM5x8.65XA (4.0 Nm)
	Shim			V16BS
	Wrench (screw)			WT15IP
	Wrench (shim)			WH35L
	Wrench	WT07IP	WT07IP	WT15IP

Insert

Finishing A148	Medium Cut A151	Roughing A152	PCBN/PCD A191

System code > A322

Grade selection > A42

Technical info > A501

Cutting data > A366



A

Turning

B

Milling

C

Drilling

D

Technical Information

E

Index

CP** steel boring bar S-Clamping

SCLPR/L Kr: 95°

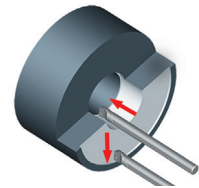
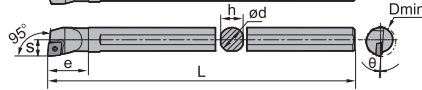
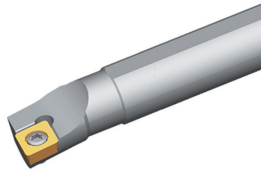



Right hand style

Article	Stock		Dimensions [mm]								Inserts
	R	L	ød	L	h	s	e	D _{min}	θ		
S10K-SCLPR/L06	●	●	10	125	9	6	17	12	-7	CP**0602**	
S12M-SCLPR/L06	●	●	12	150	11	8	20	16	-4	CP**0602**	
S16Q-SCLPR/L09	●	●	16	180	15	10	29	20	-4	CP**09T3**	
S20R-SCLPR/L09	○	○	20	200	18	13	35	25	-4	CP**09T3**	

● Ex stock ○ On demand

* With internal cooling

Spare parts

	Insert	CP**0602**	CP**09T3**
	ød	10-12	20-25
	Screw	I60M2.5×5.5 (1.0 Nm)	I60M3.5×8 (2.7 Nm)
	Wrench (screw)	WT07IP	WT15IP

Insert

		
Finishing	Medium Cut	Cast Iron
A124	A124	A124

System code > A322

Grade selection > A42

Technical info > A501

Cutting data > A366

DP** steel boring bar **S-Clamping**

SDQPR/L Kr: 107°30'

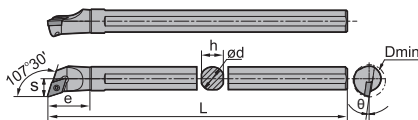
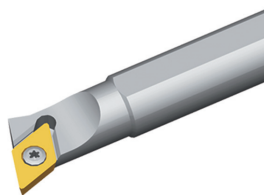



Right hand style

Article	*	Stock		Dimensions [mm]							Inserts
		R	L	ød	L	h	s	e	D _{min}	θ	
S10K-SDQPR/L07	●	●	10	125	9	7	20	13	-8	DP**0702**	
S12M-SDQPR/L07	●	●	12	150	11	9	22	16	-8	DP**0702**	
S16Q-SDQPR/L07	●	●	16	180	15	11	27	20	-6	DP**0702**	
S16Q-SDQPR/L11	●	●	16	180	15	11	32	20	-6	DP**11T3**	
S20R-SDQPR/L11	○	○	20	200	18	13	33	25	-6	DP**11T3**	

● Ex stock ○ On demand

* With internal cooling

Spare parts

	Insert	DP**0702**	DP**0702**	DP**11T3**
	ød	10-12	16	16-20
	Screw	I60M2.5×5.5 (1.0 Nm)	I60M2.5×6.5 (1.0 Nm)	I60M3.5×8 (2.7 Nm)
	Wrench (screw)	WT07IP	WT07IP	WT15IP

Insert



Finishing

A131

System code > A322

Grade selection > A42

Technical info > A501

Cutting data > A366

DP** steel boring bar S-Clamping

SDUPR/L Kr: 93°

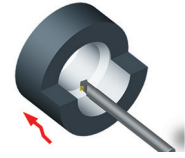
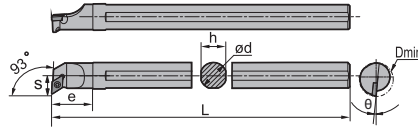
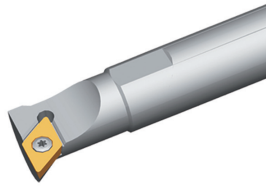



Right hand style

Article	Stock		Dimensions [mm]							Inserts
	R	L	ød	L	h	s	e	D _{min}	θ	
S10K-SDUPR/L07	●	●	10	125	9	9	18	15	-8	DP**0702**
S12M-SDUPR/L07	●	●	12	150	11	9	19	16	-8	DP**0702**
S16Q-SDUPR/L07	●	●	16	180	15	11	25	20	-6	DP**0702**

● Ex stock ○ On demand

* With internal cooling

Spare parts

	Insert	DP**0702**	DP**0702**
	ød	10-12	16
	Screw	I60M2.5×5.5 (1.0 Nm)	I60M2.5×6.5 (1.0 Nm)
	Wrench (screw)	WT07IP	WT07IP

Insert



Finishing

A131

A

Turning

B

Milling

C

Drilling

D

Technical Information

E

Index

TP steel boring bar** S-Clamping

STUPR/L Kr: 93°

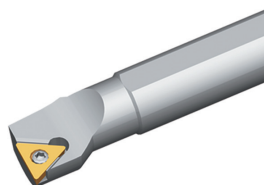

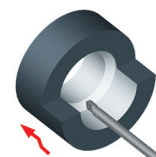
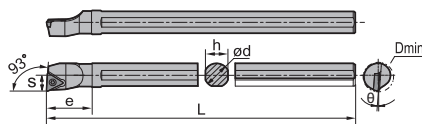

Right hand style



Article	*	Stock		Dimensions [mm]							Inserts
		R	L	ød	L	h	s	e	D _{min}	θ	
S10K-STUPR/L09	●	●	10	125	9	6	20	12	-6	TP**0902**	
S12M-STUPR/L09	●	●	12	150	11	8	22	16	-4	TP**0902**	
S12M-STUPR/L11	●	●	12	150	11	8	25	16	-4	TP**1103**	
S16Q-STUPR/L11	●	●	16	180	15	10	27	20	-3	TP**1103**	

● Ex stock ○ On demand

* With internal cooling

Spare parts			
	Insert	TP**0902**	TP**1103**
	ød	10-12	12-16
	Screw	I60M2.2×5.5 (0.8 Nm)	I60M2.5×6.5 (1.0 Nm)
	Wrench	WT07IP	WT07IP

Insert



Finishing

A147

System code > A322

Grade selection > A42

Technical info > A501

Cutting data > A366

CC** steel boring bar S-Clamping

SCFCR/L Kr: 90°

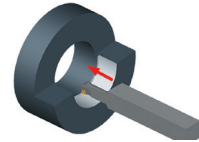
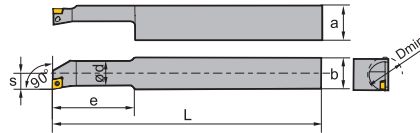
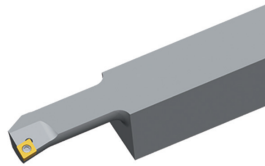

Article	*	Stock		Dimensions [mm]							Inserts
		R	L	ød	a	b	L	s	e	D _{min}	
S10M-SCFCR/L06S25	• ○	10	27	25	150	7	30	13	CC**0602**		
S12P-SCFCR/L06S25	•	12	27	25	170	9	35	16	CC**0602**		
S16Q-SCFCR/L09S25	• ○	16	27	25	180	11	40	20	CC**09T3**		
S20R-SCFCR/L09S25	•	20	27	25	200	13	45	25	CC**09T3**		
S25R-SCFCR/L12S25	• •	25	27	25	200	17	50	32	CC**1204**		

• Ex stock ○ On demand

* With internal cooling

Spare parts				
	Insert	CC**0602**	CC**09T3**	CC**1204**
	ød	10-12	16-20	25
	Screw	I60M2.5×5.5 (1.0 Nm)	I60M3.5×8 (2.7 Nm)	I60M4×12 (3.4 Nm)
	Wrench	WT07IP	WT15IP	WT20IP

Insert					
Finishing	Medium Cut	Roughing	Alum Machining	Cast Iron	PCBN/PCD
A116	A119	A121	A122	A121	A180

System code > A322

Grade selection > A42

Technical info > A501

Cutting data > A366

CC steel boring bar S-Clamping**

SCLCR Kr: 95°

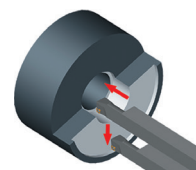
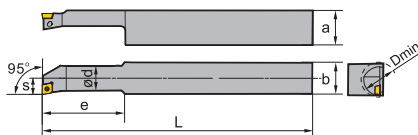
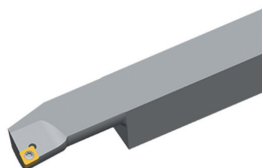

Article	*	Stock	Dimensions [mm]							Inserts
			ød	a	b	L	s	e	D _{min}	
S10M-SCLCR06S20		○	10	22	20	150	7	30	13	CC**0602**
S12P-SCLCR06S20		○	12	22	20	170	9	35	16	CC**0602**
S16Q-SCLCR09S20		●	16	22	20	180	11	40	20	CC**09T3**
S20R-SCLCR09S20		●	20	22	20	200	13	60	25	CC**09T3**

● Ex stock ○ On demand

* With internal cooling

Spare parts			
	Insert	CC**0602**	CC**09T3**
	ød	10-12	16-20
	Screw	I60M2.5x5.5 (1.0 Nm)	I60M3.5x8 (2.7 Nm)
	Wrench	WT07IP	WT15IP

Insert					
Finishing	Medium Cut	Roughing	Alum Machining	Cast Iron	PCBN/PCD
A116	A119	A121	A122	A121	A180

CP** solid carbide boring bar S-Clamping

SCLPR/L Kr: 95°

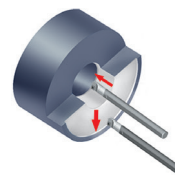
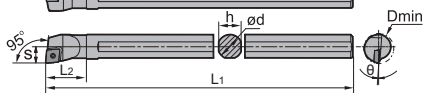
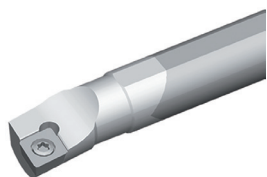



Right hand style

Article	*	Stock		Dimensions [mm]							Inserts
		R	L	∅D	∅d	h	s	L ₁	L ₂	θ	
C10M-SCLPR/L06	●	●	12	10	9	6	150	17	7	CP**0602**	
C12Q-SCLPR/L06	●	○	16	12	11	8	180	20	4	CP**0602**	
C16R-SCLPR/L09	●	●	20	16	15	10	200	29	4	CP**09T3**	
E16R-SCLPR/L09	*	○	19	16	15.5	10	200	-	-2	CP**09T3**	
C20S-SCLPR/L09	●	○	25	20	18	13	250	35	4	CP**09T3**	
E20S-SCLPR/L09	*	○	24	20	19.5	13	250	-	-2	CP**09T3**	

● Ex stock ○ On demand

* With internal cooling

Spare parts

	Insert	CP**0602**	CP**09T3**
	∅d	10-12	16-20
	Screw	I60M2.5×5.5 (1.0 Nm)	I60M3.5×10 (2.7 Nm)
	Wrench (screw)	WT07IP	WT15IP

Insert

		
Finishing	Medium Cut	Cast Iron
A124	A124	A124

System code > A322

Grade selection > A42

Technical info > A501

Cutting data > A366

CC solid carbide boring bar** S-Clamping

SCLCR/L Kr: 95°

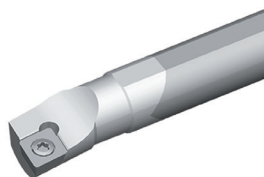

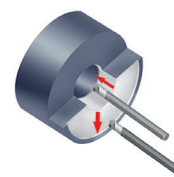
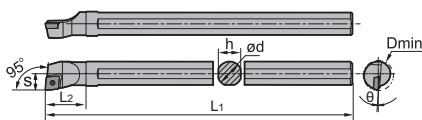

Right hand style









Article	*	Stock		Dimensions [mm]							Inserts
		R	L	ØD	ød	h	s	L ₁	L ₂	θ	
E08K-SCLCR/L06-09	*	●	●	9	8	7.5	5	125	-	-12	CC**0602**
E08K-SCLCR/L06-10	*	●	●	10	8	7.5	6	125	-	-12	CC**0602**
E10M-SCLCR/L06	*	●	●	12	10	9.5	7	150	-	-10	CC**0602**
E12Q-SCLCR/L06	*	●	●	15	12	11.5	9	180	-	-10	CC**0602**
E16R-SCLCR/L06	*	●	●	18	16	15.5	10	200	-	-8	CC**0602**
E12Q-SCLCR/L09	*	●	●	15	12	11.5	9	180	-	-9	CC**09T3**
E16R-SCLCR/L09	*	●	●	18	16	15.5	10	200	-	-10	CC**09T3**
E20S-SCLCR/L09	*	●	●	24	20	19.5	13	250	-	-8	CC**09T3**
E25T-SCLCR/L09	*	●	●	31	25	24	17	300	-	-6	CC**09T3**

● Ex stock ○ On demand

* With internal cooling

Spare parts			
	Insert	CC**0602**	CC**09T3**
	ød	8-16	12
	Screw	I60M2.5x5.5 (1.0 Nm)	I60M3.5x8 (2.7 Nm)
	Wrench (screw)	WT07IP	WT15IP

Insert					
					
Finishing	Medium Cut	Roughing	Alum Machining	Cast Iron	PCBN/PCD
A116	A119	A121	A122	A121	A180

DP** solid carbide boring bar S-Clamping

SDQPR/L Kr: 107°30'

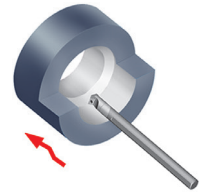
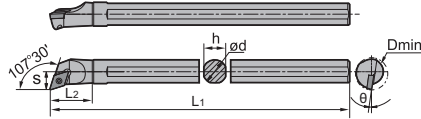
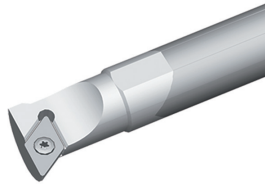



Right hand style

Article	*	Stock		Dimensions [mm]							Inserts
		R	L	ØD	ød	h	s	L ₁	L ₂	θ	
C10M-SDQPR/L07	●	●	13	10	9	7	150	20	8	DP**0702	
C12Q-SDQPR/L07	○	●	16	12	11	9	180	22	8	DP**0702	
C16R-SDQPR/L07	○	○	20	16	15	11	200	27	6	DP**0702	
C16R-SDQPR/L11	○	○	20	16	15	11	200	32	6	DP**11T3**	
C20S-SDQPR/L11	●	○	25	20	18	13	250	33	6	DP**11T3**	

● Ex stock ○ On demand

* With internal cooling

Spare parts

	Insert ød	DP**0702 10-12	DP**0702 16	DP**11T3** 16-20
 Screw		I60M2.5×5.5 (1.0 Nm)	I60M2.5×6.5 (1.0 Nm)	I60M3.5×8 (2.7 Nm)
 Wrench (screw)		WT07IP	WT07IP	WT15IP

Insert



Finishing

A131

A

Turning

B

Milling

C

Drilling

D

Technical Information

E

Index

System code > A322

Grade selection > A42

Technical info > A501

Cutting data > A366

DC solid carbide boring bar** S-Clamping

SDQCR/L Kr: 107°30'

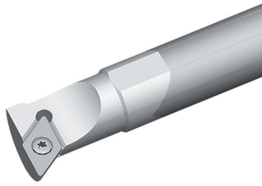

Right hand style

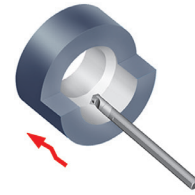
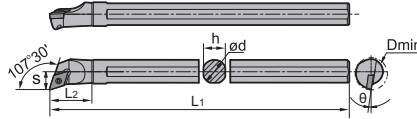

Article	*	Stock		Dimensions [mm]							Inserts
		R	L	ØD	ød	h	s	L ₁	L ₂	θ	
E08K-SDQCR/L07	*	●	●	11	8	7.5	6.5	125	-	-12	DC**0702**
E10M-SDQCR/L07	*	●	●	12	10	9.5	7	150	-	-10	DC**0702**
E12Q-SDQCR/L07	*	●	●	15	12	11.5	9	180	-	-10	DC**0702**
E16R-SDQCR/L07	*	●	○	18	16	15.5	10	200	27-	-6	DC**0702**
E20S-SDQCR/L07	*	●	○	24	20	19.5	13	250	33-	-4	DC**0702**
E16R-SDQCR/L11	*	●	●	18	16	15.5	10	200	-	-8	DC**11T3**
E20S-SDQCR/L11	*	●	○	24	20	19.5	13	250	-	-8	DC**11T3**
E25T-SDQCR/L11	*	●	○	31	25	24	17	300	-	-6	DC**11T3**

● Ex stock ○ On demand

* With internal cooling

Spare parts

	Insert	DC**0702**	DC**11T3**
	ød	8-20	16-25
	Screw	I60M2.5x5.5 (1.0 Nm)	I60M3.5x10 (2.7 Nm)
	Wrench (screw)	WT07IP	WT15IP

Insert

Finishing A126	Medium Cut A127	Roughing A129	Alum Machining A129	Cast Iron A129	PCBN/PCD A184

System code > A322

Grade selection > A42

Technical info > A501

Cutting data > A366

DP** solid carbide boring bar S-Clamping

SDUPR/L Kr: 93°

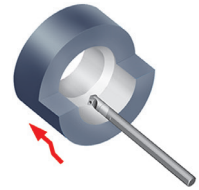
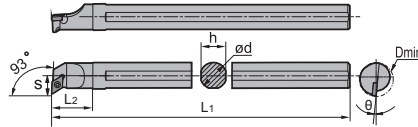
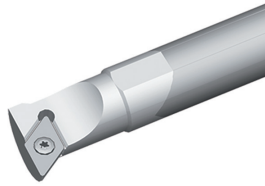



Right hand style

Article	Stock		Dimensions [mm]							Inserts
	R	L	ØD	ød	h	s	L ₁	L ₂	θ	
C10M-SDUPR/L07	●	●	15	10	9	9	150	18	8	DP**0702**
C12Q-SDUPR/L07	●	○	16	12	11	9	180	19	8	DP**0702**
C16R-SDUPR/L07	○	○	20	16	15	11	200	25	6	DP**0702**

● Ex stock ○ On demand

* With internal cooling

Spare parts

	Insert	DP**0702**
	ød	15-20
	Screw	I60M2.5×5.5 (1.0 Nm)
	Wrench	WT07IP

Insert



Finishing

A131

System code > A322

Grade selection > A42

Technical info > A501

Cutting data > A366

DC solid carbide boring bar S-Clamping**

SDUCR/L Kr: 93°

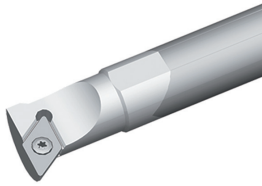

Right hand style

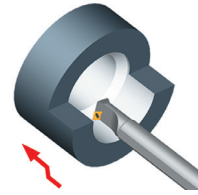
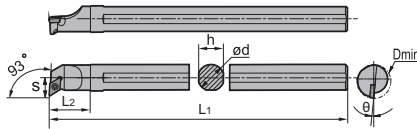

Article	*	Stock		Dimensions [mm]							Inserts
		R	L	ØD	ød	h	s	L ₁	L ₂	θ	
E10M-SDUCR/L07	*	●	○	12	10	9.5	7	150	-	-10	DC**0702**
E12Q-SDUCR/L07	*	●	●	15	12	11.5	9	180	-	-10	DC**0702**
E16R-SDUCR/L07	*	●	○	18	16	15.5	10	200	-	-6	DC**0702**
E20S-SDUCR/L07	*	○	○	24	20	19.5	13	250	-	-4	DC**0702**
E16R-SDUCR/L11	*	●	○	18	16	15.5	10	200	-	-8	DC**11T3**
E20S-SDUCR/L11	*	●	●	24	20	19.5	13	250	-	-8	DC**11T3**
E25T-SDUCR/L11	*	○	○	31	25	24	17	300	-	-6	DC**11T3**

● Ex stock ○ On demand

* With internal cooling

Spare parts

	Insert	DC**0702**	DC**11T3**
	ød	10-20	16-25
	Screw	I60M2.5x5.5 (1.0 Nm)	I60M3.5x10 (2.7 Nm)
	Wrench (screw)	WT07IP	WT15IP

Insert

Finishing A126	Medium Cut A127	Roughing A129	Alum Machining A129	Cast Iron A129	PCBN/PCD A184

System code > A322

Grade selection > A42

Technical info > A501

Cutting data > A366



A

Turning

B

Milling

C

Drilling

D

Technical Information

E

Index

TP** solid carbide boring bar S-Clamping

STUPR/L Kr: 93°

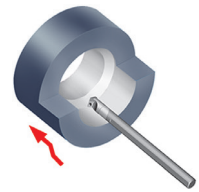
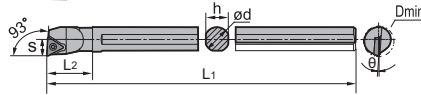
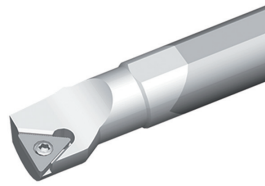



Right hand style

Article	Stock		Dimensions [mm]							Inserts
	R	L	ØD	ød	h	s	L ₁	L ₂	θ	
C10M-STUPR/L09	○	○	12	10	9	6	150	20	6	TP**0902**
C12Q-STUPR/L09	●		16	12	11	8	180	22	4	TP**0902**
C12Q-STUPR/L11	●		16	12	11	8	180	25	4	TP**1103
C16R-STUPR/L11	○	○	20	16	15	10	200	27	3	TP**1103

● Ex stock ○ On demand

* With internal cooling

Spare parts

Insert		TP**0902**	TP**1103
		10-12	12-16
	Screw	I60M2.2×5.5 (0.8 Nm)	I60M2.5×6.5 (1.0 Nm)
	Wrench (screw)	WT07IP	WT07IP

Insert



Finishing

A147

A

Turning

B

Milling

C

Drilling

D

Technical Information

E

Index

System code > A322

Grade selection > A42

Technical info > A501

Cutting data > A366

TC solid carbide boring bar** S-Clamping

STFCR/L Kr: 90°

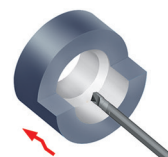
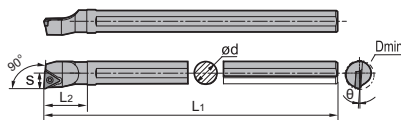
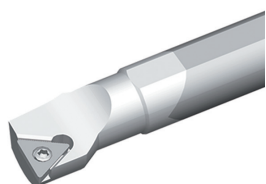

Right hand style

Article	*	Stock		Dimensions [mm]							Inserts
		R	L	ØD	ød	h	s	L ₁	L ₂	θ	
E08K-STFCR/L09	*	○	●	11	8	7.5	6	125	-	-12	TC**0902**
E10M-STFCR/L09	*	○	○	12	10	9.5	7	150	-	-10	TC**0902**
E12Q-STFCR/L11	*	○	○	15	12	11.5	9	180	-	-10	TC**1102**
E16R-STFCR/L11	*	○	○	18	16	15.5	10	200	-	-8	TC**1102**
E20S-STFCR/L11	*	○	○	24	20	19.5	13	250	-	-8	TC**1102**
E20S-STFCR/L16	*	○	○	24	20	19.5	13	250	-	-8	TC**16T3**
E25T-STFCR/L16	*	○	○	31	25	24	17	300	-	-6	TC**16T3**

- Ex stock ○ On demand
- * With internal cooling

Spare parts

Insert		TC**0902**	TC**1102**	TC**16T3**
		8-10	12-20	20-25
	Screw	I60M2.2x5.5 (0.8 Nm)	I60M2.5x5.5 (1.0 Nm)	I60M3.5x10 (2.7 Nm)
	Wrench (screw)	WT07IP	WT07IP	WT15IP

Insert

Finishing A141	Medium Cut A142	Roughing A143	Alum Machining A145	Cast Iron A143	PCBN/PCD A187

System code > A322

Grade selection > A42

Technical info > A501

Cutting data > A366



A

Turning

B

Milling

C

Drilling

D

Technical Information

E

Index

TC** solid carbide boring bar S-Clamping

STFPR/L Kr: 90°

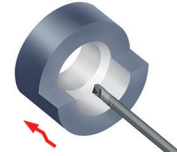
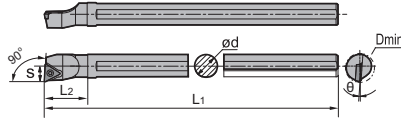
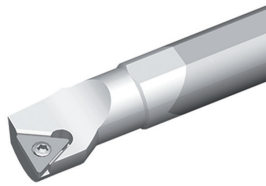



Right hand style

Article	*	Stock		Dimensions [mm]							Inserts
		R	L	ØD	ød	h	s	L ₁	L ₂	θ	
E10M-STFPR/L11	*	○	○	12	10	9.5	6	150	-	-5	TP**1103**
E12Q-STFPR/L11	*	○	○	15	12	11.5	8	180	-	-4	TP**1103**
E16R-STFPR/L11	*	○	○	19	16	15.5	10	200	-	-2	TP**1103**
E20S-STFPR/L11	*	○	○	24	20	19	13	250	-	-2	TP**1103**

● Ex stock ○ On demand

* With internal cooling

Spare parts

	Insert	TP**1103**
		10-20
	Screw	I60M3.0×7.0 (1.8 Nm)
	Wrench (screw)	WT08IP

Insert



Finishing

A147

A

Turning

B

Milling

C

Drilling

D

Technical Information

E

Index

System code > A322

Grade selection > A42

Technical info > A501

Cutting data > A366

VC solid carbide boring bar** S-Clamping

SVQCR/L Kr: 107°30'

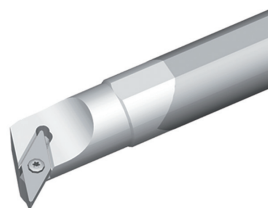

Right hand style

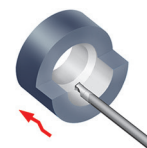
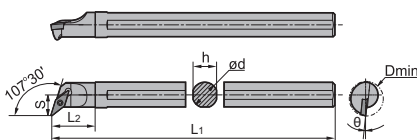

Article	*	Stock		Dimensions [mm]						Inserts
		R	L	ØD	ød	h	s	L ₁	L ₂	
C16R-SVQCR/L11	○	○	22	16	15	13	200	28	-6	VC**1103**
C20S-SVQCR/L11	○	○	26	20	18	15	250	32	-4	VC**1103**

● Ex stock ○ On demand

* With internal cooling

Spare parts		
	Insert	VC**1103**
		16-20
	Screw	I60M2.5×6.5 (1.0 Nm)
	Wrench (screw)	WT07IP

Insert		
Finishing	Alum Machining	PCBN/PCD
A156	A154	A193

System code > A322

Grade selection > A42

Technical info > A501

Cutting data > A366

VC** solid carbide boring bar S-Clamping

SVUCR/L Kr: 93°

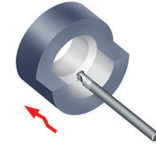
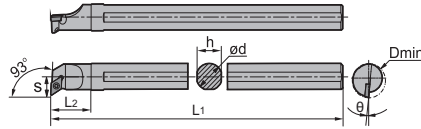
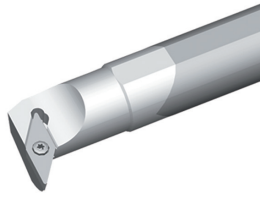

Right hand style

Article	*	Stock		Dimensions [mm]							Inserts
		R	L	ØD	ød	h	s	L ₁	L ₂	θ	
C16R-SVUCR/L11		○		24	16	15	15	200	25	6	VC**1103**
E16R-SVUCR/L11	*	○	○	22	16	15	13	200	-	-6.5	VC**1103**
C20S-SVUCR/L11		●	●	28	20	18	17	250	30	4	VC**1103**
E20S-SVUCR/L11	*	○	○	27	20	18	13	250	-	-6.5	VC**1103**
E25T-SVUCR/L16	*	○	○	35	25	23	20.5	300	-	-6.5	VC**1604**

● Ex stock ○ On demand

* With internal cooling

Spare parts

	Insert	VC**1103** 16-20	VC**1604** 25
	Screw	I60M2.5×6.5 (1.0 Nm)	I60M3.5×10 (2.7 Nm)
	Wrench (screw)	WT07IP	WT15IP

Insert

Finishing	Medium Cut	Alum Machining	PCBN/PCD
A156	A156	A154	A193

System code > A322

Grade selection > A42

Technical info > A501

Cutting data > A366

ZNEX solid carbide boring bar **S clamping**

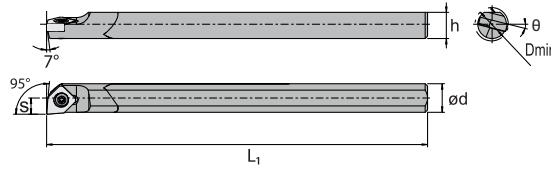

SZLNR Kr: 95°



Article	*	Stock		Dimensions [mm]						Insert	
		R	L	D _{min}	ød	h	s	L ₁	L ₂	θ	
C06X-SZLNR04	●			7	6	5,5	3,4	80	-	-14	ZNEX0401**

● Ex stock ○ On demand

* With internal cooling

Spare parts		
	Insert	ZNEX0401**
	ød	6
	Screw	I60M2x3,7 (0,5 Nm)
	Wrench (Screw)	WT06IP

C06X holder**

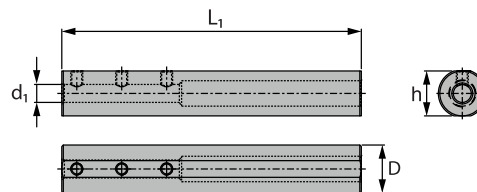

SZLNR Kr: 95°



Article	Stock	Dimensions [mm]			
		D	d ₁	L ₁	h
SHSZ1600.06.100	●	16	6	100	15

● Ex stock ○ On demand

* With internal cooling

Spare parts		
	Screw	M4x5SH
	Wrench (Screw)	WH20L

Register on our website and order online now.



www.zcct-europe.com

Turning insert, negative

	Material group	Composition / structure / heat treatment		Brinell hardness HB	Machining group	Starting values for cutting speed v_c [m/min]									
						HC (CVD)									
						YBC103			YB6315			YBC152			
						Feed rate [mm]			Feed rate [mm]			Feed rate [mm]			
		0,1	0,2	0,6	0,1	0,2	0,6	0,1	0,2	0,6					
P	Unalloyed steel	approx. 0,15 % C	annealed	125	1	520	420	280	500	400	270	500	400	270	
		approx. 0,45 % C	annealed	190	2	440	360	250	420	340	230	420	340	230	
		approx. 0,45 % C	tempered	250	3	350	300	220	330	280	200	330	280	200	
		approx. 0,75 % C	annealed	270	4	340	290	210	320	270	190	320	270	190	
		approx. 0,75 % C	tempered	300	5	300	260	190	280	240	170	280	240	170	
	Low-alloyed steel			annealed	180	6	420	320	200	400	300	180	400	300	180
				tempered	275	7	300	250	170	280	230	150	280	230	150
				tempered	300	8	280	240	170	260	220	150	260	220	150
				tempered	350	9	250	210	140	230	190	120	230	190	120
		High-alloyed steel and high-alloyed tool steel			annealed	200	10	380	310	210	360	290	190	360	290
			hardened and tempered	325	11	210	180	150	190	160	130	190	160	130	
M	Stainless steel	ferritic/martensitic	annealed	200	12										
			martensitic	tempered	240	13									
			austenitic	quench hardened	180	14									
			austenitic-ferritic		230	15									
K	Grey cast iron	perlitic/ferritic		180	16										
		perlitic (martensitic)		260	17										
	Cast iron with spheroidal graphite	ferritic		160	18										
		perlitic		250	19										
	Malleable cast iron	ferritic		130	20										
		perlitic		230	21										
N	Aluminium wrought alloys	cannot be hardened		60	22										
		hardenable	hardened	100	23										
	Cast aluminium alloys	$\leq 12\%$ Si, cannot be hardened		75	24										
		$\leq 12\%$ Si, hardenable	hardened	90	25										
		$> 12\%$ Si, cannot be hardened		130	26										
	Copper and copper alloys (bronze/brass)	machining steel, PB > 1%		110	27										
		CuZn, CuSnZn		90	28										
	CuSn, Pb-free copper, electrolytic copper		100	29											
S	Heat-resistant alloys	Fe-based alloys	annealed	200	30										
			hardened	280	31										
		Ni or Co base	annealed	250	32										
			hardened	350	33										
		cast	320	34											
Titanium alloys	pure titanium		R _m 400	35											
	α and β alloys	hardened	R _m 1050	36											
H	Hardened steel		hardened and tempered	55 HRC	37										
			hardened and tempered	60 HRC	38										
	Hard cast iron		cast	400	39										
	Hardened cast iron		hardened and tempered	55 HRC	40										
X	Non-metallic materials	Thermoplastics			41										
		Thermosetting plastics			42										
		Plastic, glass-fibre reinforced GFRP			43										
		Plastic, carbon fibre reinforced CFRP			44										
		Graphite			45										
		Wood			46										

Note: The given cutting values are guide values, which were determined under ideal conditions.
 The values have to be adapted in individual cases.
 For examples of material for cutting tool groups view page D11.

A
 Turning
B
 Milling
C
 Drilling
D
 Technical Information
E
 Index

Starting values for cutting speed v_c [m/min]																							
HC (CVD)																							
YBC203			YBC252			YBC352			YBM153			YBM253			YBD102			YB7315			YBD152		
Feed rate [mm]			Feed rate [mm]			Feed rate [mm]			Feed rate [mm]			Feed rate [mm]			Feed rate [mm]			Feed rate [mm]			Feed rate [mm]		
0,1	0,4	0,8	0,1	0,4	0,8	0,2	0,5	1,0	0,2	0,4	0,6	0,2	0,4	0,6	0,1	0,3	0,4	0,1	0,3	0,5	0,1	0,3	0,5
480	370	230	480	370	230	430	330	220															
400	310	190	400	310	190	350	270	180															
310	250	160	310	250	160	260	210	150															
300	240	150	300	240	150	250	200	140															
260	210	130	260	210	130	210	170	120															
380	290	170	380	290	170	320	240	150															
260	210	140	260	210	140	200	170	120															
240	200	140	240	200	140	180	160	120															
220	180	110	220	180	110	150	130	90															
310	250	170	310	250	170	220	180	130															
150	130	100	150	130	100	-	-	-															
									380	295	210	350	265	180									
									190	155	120	150	110	65									
									250	200	150	200	140	80									
									200	160	130	160	115	70									
															530	380	220	600	410	220	540	375	210
															240	200	150	330	240	150	280	210	140
															300	210	145	340	250	160	290	215	140
															220	150	105	260	190	120	210	155	100
															330	265	220	370	300	230	320	265	210
															230	155	100	280	200	120	230	165	100

- HC Coated carbide
- HT Uncoated carbide, primary component (TiC) or (TiN), cermet
- HW Uncoated carbide, primary component (WC)
- BL Cubic boron nitride with low BN content
- BH Cubic boron nitride with high BN content
- CN Si3N4 ceramic
- CM Mixed ceramic
- HC₁ Coated cermet
- BC CBN with coating
- CC Coated cutting ceramic
- CR Cutting ceramic, primary component aluminium oxide (Al₂O₃), reinforced
- DP Polycrystalline diamond

A

Turning

B

Milling

C

Drilling

D

Technical Information

E

Index



Turning insert, negative

	Material group	Composition / structure / heat treatment		Brinell hardness HB	Machining group	Starting values for cutting speed v_c [m/min]									
						HC (CVD)			HC (PVD)						
						YBD152C			YBG101			YBG102			
						Feed rate [mm]			Feed rate [mm]			Feed rate [mm]			
					0,1	0,3	0,5	0,1	0,3	0,6	0,1	0,3	0,6		
P	Unalloyed steel	approx. 0,15 % C	annealed	125	1										
		approx. 0,45 % C	annealed	190	2										
		approx. 0,45 % C	tempered	250	3										
		approx. 0,75 % C	annealed	270	4										
		approx. 0,75 % C	tempered	300	5										
	Low-alloyed steel		annealed	180	6										
			tempered	275	7										
			tempered	300	8										
			tempered	350	9										
	High-alloyed steel and high-alloyed tool steel		annealed	200	10										
			hardened and tempered	325	11										
M	Stainless steel	ferritic/martensitic	annealed	200	12							360	290	200	
		martensitic	tempered	240	13							180	150	110	
		austenitic	quench hardened	180	14							240	190	140	
		austenitic-ferritic		230	15							190	150	110	
K	Grey cast iron	perlitic/ferritic		180	16	570	395	220							
		perlitic (martensitic)		260	17	310	230	150							
	Cast iron with spheroidal graphite	ferritic		160	18	310	230	150							
		perlitic		250	19	230	170	110							
	Malleable cast iron	ferritic		130	20	340	280	220							
		perlitic		230	21	250	180	110							
N	Aluminium wrought alloys	cannot be hardened		60	22				2000	1200	-	2000	1200	-	
		hardenable	hardened	100	23				610	420	-	610	420	-	
	Cast aluminium alloys	$\leq 12\%$ Si, cannot be hardened		75	24				550	300	-	550	300	-	
		$\leq 12\%$ Si, hardenable	hardened	90	25				360	190	-	360	190	-	
		$> 12\%$ Si, cannot be hardened		130	26				320	170	-	320	170	-	
	Copper and copper alloys (bronze/brass)	machining steel, PB > 1%			110	27				730	350	-	730	350	-
		CuZn, CuSnZn			90	28				370	330	-	370	330	-
		CuSn, Pb-free copper, electrolytic copper			100	29				270	200	-	270	200	-
	S	Heat-resistant alloys	Fe-based alloys	annealed	200	30							65	45	-
				hardened	280	31							60	40	-
Ni or Co base			annealed	250	32							60	40	-	
			hardened	350	33							55	35	-	
cast		320	34							55	35	-			
Titanium alloys	pure titanium		R _m 400	35							100	60	-		
α and β alloys	hardened		R _m 1050	36							80	40	-		
H	Hardened steel		hardened and tempered	55 HRC	37										
			hardened and tempered	60 HRC	38										
	Hard cast iron		cast	400	39										
	Hardened cast iron		hardened and tempered	55 HRC	40										
X	Non-metallic materials	Thermoplastics			41										
		Thermosetting plastics			42										
		Plastic, glass-fibre reinforced GFRP			43										
		Plastic, carbon fibre reinforced CFRP			44										
		Graphite			45										
		Wood			46										

Note: The given cutting values are guide values, which were determined under ideal conditions.
 The values have to be adapted in individual cases.
 For examples of material for cutting tool groups view page D11.

A Turning
B Milling
C Drilling
D Technical Information
E Index

Starting values for cutting speed v_c [m/min]																							
HC (PVD)															HC ₁			HT					
YBS103			YBG105			YB9320			YBG205			YPD201			YNG151C			YNG151			YNT251		
Feed rate [mm]			Feed rate [mm]			Feed rate [mm]			Feed rate [mm]			Feed rate [mm]			Feed rate [mm]			Feed rate [mm]			Feed rate [mm]		
0,1	0,3	0,6	0,1	0,3	0,6	0,1	0,3	0,6	0,1	0,3	0,6	0,1	0,3	0,6	0,1	0,2	0,4	0,1	0,2	0,4	0,1	0,2	0,4
															510	350	–	510	350	–	510	350	–
															430	270	–	430	270	–	430	270	–
															330	220	–	330	220	–	330	220	–
															320	200	–	320	200	–	320	200	–
															280	170	–	280	170	–	280	170	–
															400	240	–	400	240	–	400	240	–
															290	180	–	290	180	–	290	180	–
															240	170	–	240	170	–	240	170	–
															220	150	–	220	150	–	220	150	–
															340	220	–	340	220	–	340	220	–
															180	110	–	180	110	–	180	110	–
	360	290	200	360	290	200	360	290	200	320	250	160	360	290	200								
	180	150	110	180	150	110	190	155	110	170	150	110	190	155	110								
	240	190	140	240	190	140	250	210	150	230	190	140	250	210	150								
	190	150	110	190	150	110	200	165	120	180	150	110	200	165	120								
															430	365	280	430	365	280	430	365	280
															390	340	270	390	340	270	390	340	270
															360	300	220	360	300	220	360	300	220
															340	295	230	340	295	230	340	295	230
															310	260	190	310	260	190	310	260	190
															250	210	150	250	210	150	250	210	150
	80	65	45	65	45	–	55	35	–	55	–	–	–	65	45								
	75	60	40	60	40	–	50	30	–	50	–	–	–	60	40								
	70	60	40	60	40	–	50	30	–	50	–	–	–	60	40								
	65	55	35	55	35	–	45	25	–	45	–	–	–	55	35								
	65	55	35	55	35	–	45	25	–	45	–	–	–	55	35								
	110	100	60	100	60	–	80	60	–	70	–	–	–	100	60								
	90	80	40	80	40	–	60	40	–	50	–	–	–	80	40								

HC Coated carbide
 HT Uncoated carbide, primary component (TiC) or (TiN), cermet
 HW Uncoated carbide, primary component (WC)
 BL Cubic boron nitride with low BN content
 BH Cubic boron nitride with high BN content
 CN Si₃N₄ ceramic
 CM Mixed ceramic
 HC₁ Coated cermet
 BC CBN with coating
 CC Coated cutting ceramic
 CR Cutting ceramic, primary component aluminium oxide (Al₂O₃), reinforced
 DP Polycrystalline diamond

A

Turning

B

Milling

C

Drilling

D

Technical Information

E

Index



Turning insert, negative

Material group	Composition / structure / heat treatment		Brinell hardness HB	Machining group	Starting values for cutting speed v_c [m/min]									
					HW						BL			
					YD101			YD201			YCB112			
					Feed rate [mm]			Feed rate [mm]			Feed rate [mm]			
	0,05	0,2	0,35	0,1	0,2	0,3	0,1	0,2	0,3					
P Unalloyed steel	approx. 0,15 % C	annealed	125	1										
	approx. 0,45 % C	annealed	190	2										
	approx. 0,45 % C	tempered	250	3										
	approx. 0,75 % C	annealed	270	4										
	approx. 0,75 % C	tempered	300	5										
P Low-alloyed steel		annealed	180	6										
		tempered	275	7										
		tempered	300	8										
		tempered	350	9										
High-alloyed steel and high-alloyed tool steel		annealed	200	10										
		hardened and tempered	325	11										
M Stainless steel	ferritic/martensitic	annealed	200	12										
	martensitic	tempered	240	13										
	austenitic	quench hardened	180	14										
	austenitic-ferritic		230	15										
Grey cast iron	perlitic/ferritic		180	16										
	perlitic (martensitic)		260	17										
Cast iron with spheroidal graphite	ferritic		160	18										
	perlitic		250	19										
Malleable cast iron	ferritic		130	20										
	perlitic		230	21										
N Aluminium wrought alloys	cannot be hardened		60	22	1750	1200	800	1750	1200	800				
	hardenable	hardened	100	23	510	380	250	510	380	250				
	≤ 12% Si, cannot be hardened		75	24	460	320	175	460	320	175				
	≤ 12% Si, hardenable	hardened	90	25	300	205	110	300	205	110				
Cast aluminium alloys	> 12% Si, cannot be hardened		130	26	270	185	100	270	185	100				
	machining steel, PB> 1%		110	27	610	410	205	610	410	205				
Copper and copper alloys (bronze/brass)	CuZn, CuSnZn		90	28	310	250	195	310	250	195				
	CuSn, Pb-free copper, electrolytic copper		100	29	225	170	115	225	170	115				
S Heat-resistant alloys	Fe-based alloys	annealed	200	30										
		hardened	280	31										
	Ni or Co bass	annealed	250	32								180	160	140
		hardened	350	33								160	140	120
Titanium alloys	cast	320	34								120	100	80	
	pure titanium		R _m 400	35										
	α and β alloys	hardened	R _m 1050	36										
H Hardened steel		hardened and tempered	55 HRC	37								220	170	130
		hardened and tempered	60 HRC	38								200	160	120
Hard cast iron		cast	400	39								200	150	100
Hardened cast iron		hardened and tempered	55 HRC	40								200	150	100
X Non-metallic materials	Thermoplastics			41										
	Thermosetting plastics			42										
	Plastic, glass-fibre reinforced GFRP			43										
	Plastic, carbon fibre reinforced CFRP			44										
	Graphite			45										
	Wood			46										

Note: The given cutting values are guide values, which were determined under ideal conditions. The values have to be adapted in individual cases. For examples of material for cutting tool groups view page D11.

A Turning
B Milling
C Drilling
D Technical Information
E Index

Turning insert, negative

	Material group	Composition / structure / heat treatment		Brinell hardness HB	Machining group	Starting values for cutting speed v_c [m/min]									
						BC			BH			CM			
						YZB630C			YZB233			CA1000			
						Feed rate [mm]			Feed rate [mm]			Feed rate [mm]			
		0,1	0,3	0,5	0,3	0,9	1,5	0,1	0,6	1,5					
P	Unalloyed steel	approx. 0,15 % C	annealed	125	1										
		approx. 0,45 % C	annealed	190	2										
		approx. 0,45 % C	tempered	250	3										
		approx. 0,75 % C	annealed	270	4										
		approx. 0,75 % C	tempered	300	5										
	Low-alloyed steel		annealed	180	6										
			tempered	275	7										
			tempered	300	8										
			tempered	350	9										
	High-alloyed steel and high-alloyed tool steel		annealed	200	10										
			hardened and tempered	325	11										
M	Stainless steel	ferritic/martensitic	annealed	200	12										
		martensitic	tempered	240	13										
		austenitic	quench hardened	180	14										
		austenitic-ferritic		230	15										
K	Grey cast iron	perlitic/ferritic		180	16				1500	950	400				
		perlitic (martensitic)		260	17				1250	780	320				
	Cast iron with spheroidal graphite	ferritic		160	18				-	-	-				
		perlitic		250	19				500	300	100				
	Malleable cast iron	ferritic		130	20				-	-	-				
		perlitic		230	21				500	300	100				
N	Aluminium wrought alloys	cannot be hardened		60	22										
		hardenable	hardened	100	23										
	Cast aluminium alloys	≤ 12% Si, cannot be hardened		75	24										
		≤ 12% Si, hardenable	hardened	90	25										
		> 12% Si, cannot be hardened		130	26										
	Copper and copper alloys (bronze/brass)	machining steel, PB> 1%			110	27									
		CuZn, CuSnZn			90	28									
		CuSn, Pb-free copper, electrolytic copper			100	29									
S	Heat-resistant alloys	Fe-based alloys	annealed	200	30										
			hardened	280	31										
		Ni or Co base	annealed	250	32										
			hardened	350	33										
	Titanium alloys		cast	320	34										
		pure titanium		R _m 400	35										
	α and β alloys	hardened	R _m 1050	36											
H	Hardened steel		hardened and tempered	55 HRC	37	220	170	130				180	150	120	
			hardened and tempered	60 HRC	38	200	160	120				140	120	80	
	Hard cast iron		cast	400	39	200	150	100				80	60	40	
	Hardened cast iron		hardened and tempered	55 HRC	40	200	150	100				-	-	-	
X	Non-metallic materials	Thermoplastics			41										
		Thermosetting plastics			42										
		Plastic, glass-fibre reinforced GFRP			43										
		Plastic, carbon fibre reinforced CFRP			44										
		Graphite			45										
		Wood			46										

Note: The given cutting values are guide values, which were determined under ideal conditions.
 The values have to be adapted in individual cases.
 For examples of material for cutting tool groups view page D11.

A Turning
B Milling
C Drilling
D Technical Information
E Index

Turning insert, positive

	Material group	Composition / structure / heat treatment		Brinell hardness HB	Machining group	Starting values for cutting speed v_c [m/min]									
						HC (CVD)									
						YBC103			YB6315			YBC152			
						Feed rate [mm]			Feed rate [mm]			Feed rate [mm]			
		0,1	0,2	0,4	0,1	0,2	0,4	0,1	0,2	0,4					
P	Unalloyed steel	approx. 0,15 % C	annealed	125	1	460	400	280	450	390	270	450	390	270	
		approx. 0,45 % C	annealed	190	2	390	340	240	380	330	230	380	330	230	
		approx. 0,45 % C	tempered	250	3	310	275	210	300	265	200	300	265	200	
		approx. 0,75 % C	annealed	270	4	300	265	200	290	255	190	290	255	190	
		approx. 0,75 % C	tempered	300	5	260	235	180	250	225	170	250	225	170	
	Low-alloyed steel			annealed	180	6	370	310	190	360	300	180	360	300	180
				tempered	275	7	260	220	160	250	210	150	250	210	150
				tempered	300	8	240	210	160	230	200	150	230	200	150
				tempered	350	9	210	180	130	200	170	120	200	170	120
		High-alloyed steel and high-alloyed tool steel			annealed	200	10	330	285	200	320	275	190	320	275
			hardened and tempered	325	11	170	160	140	160	150	130	160	150	130	
M	Stainless steel	ferritic/martensitic	annealed	200	12										
			martensitic	tempered	240	13									
			austenitic	quench hardened	180	14									
			austenitic-ferritic		230	15									
K	Grey cast iron	perlitic/ferritic		180	16										
		perlitic (martensitic)		260	17										
	Cast iron with spheroidal graphite	ferritic		160	18										
		perlitic		250	19										
	Malleable cast iron	ferritic		130	20										
		perlitic		230	21										
N	Aluminium wrought alloys	cannot be hardened		60	22										
		hardenable	hardened	100	23										
	Cast aluminium alloys	$\leq 12\%$ Si, cannot be hardened		75	24										
		$\leq 12\%$ Si, hardenable	hardened	90	25										
		$> 12\%$ Si, cannot be hardened		130	26										
	Copper and copper alloys (bronze/brass)	machining steel, PB > 1%			110	27									
		CuZn, CuSnZn			90	28									
	CuSn, Pb-free copper, electrolytic copper			100	29										
S	Heat-resistant alloys	Fe-based alloys	annealed	200	30										
			hardened	280	31										
		Ni or Co base	annealed	250	32										
			hardened	350	33										
		cast	320	34											
Titanium alloys	pure titanium		R _m 400	35											
	α and β alloys	hardened	R _m 1050	36											
H	Hardened steel		hardened and tempered	55 HRC	37										
			hardened and tempered	60 HRC	38										
	Hard cast iron		cast	400	39										
	Hardened cast iron		hardened and tempered	55 HRC	40										
X	Non-metallic materials	Thermoplastics			41										
		Thermosetting plastics			42										
		Plastic, glass-fibre reinforced GFRP			43										
		Plastic, carbon fibre reinforced CFRP			44										
		Graphite			45										
		Wood			46										

Note: The given cutting values are guide values, which were determined under ideal conditions.
 The values have to be adapted in individual cases.
 For examples of material for cutting tool groups view page D11.

A
 Turning
B
 Milling
C
 Drilling
D
 Technical Information
E
 Index

Starting values for cutting speed v_c [m/min]																							
HC (CVD)																							
YBC203			YBC252			YBC352			YBM153			YBM253			YBD102			YB7315			YBD152		
Feed rate [mm]			Feed rate [mm]			Feed rate [mm]			Feed rate [mm]			Feed rate [mm]			Feed rate [mm]			Feed rate [mm]			Feed rate [mm]		
0,1	0,3	0,6	0,1	0,3	0,6	0,2	0,4	0,6	0,1	0,2	0,4	0,1	0,2	0,4	0,1	0,2	0,4	0,1	0,2	0,4	0,1	0,2	0,4
430	350	230	430	350	230	390	310	230															
360	295	190	360	295	190	315	250	190															
280	235	160	280	235	160	230	195	160															
270	225	150	270	225	150	220	185	150															
235	195	130	235	195	130	185	155	120															
340	270	170	340	270	170	290	225	150															
235	195	140	235	195	140	170	150	130															
220	180	140	220	180	140	150	140	130															
190	155	110	190	155	110	130	110	90															
280	230	170	280	230	170	180	160	140															
130	115	100	130	115	100	-	-	-															
									360	340	260	330	300	230									
									180	170	140	150	130	95									
									240	220	170	195	170	115									
									190	175	140	160	140	100									
															480	345	200	540	370	200	490	340	190
															220	180	135	300	220	135	250	190	130
															270	210	130	300	230	145	260	200	125
															200	150	95	230	180	110	190	140	90
															275	240	180	310	260	190	265	230	170
															190	145	85	230	170	100	190	140	90

- HC Coated carbide
- HT Uncoated carbide, primary component (TiC) or (TiN), cermet
- HW Uncoated carbide, primary component (WC)
- BL Cubic boron nitride with low BN content
- BH Cubic boron nitride with high BN content
- CN Si3N4 ceramic
- CM Mixed ceramic
- HC₁ Coated cermet
- BC CBN with coating
- CC Coated cutting ceramic
- CR Cutting ceramic, primary component aluminium oxide (Al₂O₃), reinforced
- DP Polycrystalline diamond



Turning insert, positive

	Material group	Composition / structure / heat treatment		Brinell hardness HB	Machining group	Starting values for cutting speed v_c [m/min]									
						HC (CVD)			HC (PVD)						
						YBD152C			YBG101			YBG102			
						Feed rate [mm]			Feed rate [mm]			Feed rate [mm]			
			0,1	0,2	0,4	0,1	0,2	0,4	0,1	0,2	0,4				
P	Unalloyed steel	approx. 0,15 % C	annealed	125	1										
		approx. 0,45 % C	annealed	190	2										
		approx. 0,45 % C	tempered	250	3										
		approx. 0,75 % C	annealed	270	4										
		approx. 0,75 % C	tempered	300	5										
	Low-alloyed steel		annealed	180	6										
			tempered	275	7										
			tempered	300	8										
			tempered	350	9										
		High-alloyed steel and high-alloyed tool steel		annealed	200	10									
			hardened and tempered	325	11										
M	Stainless steel	ferritic/martensitic	annealed	200	12						305	245	205		
		martensitic	tempered	240	13						150	125	100		
		austenitic	quench hardened	180	14						200	165	145		
		austenitic-ferritic		230	15						160	130	115		
K	Grey cast iron	perlitic/ferritic		180	16	520	360	200							
		perlitic (martensitic)		260	17	280	210	135							
	Cast iron with spheroidal graphite	ferritic		160	18	280	220	135							
		perlitic		250	19	210	160	100							
	Malleable cast iron	ferritic		130	20	280	245	180							
		perlitic		230	21	210	160	100							
N	Aluminium wrought alloys	cannot be hardened		60	22				1800	880	-	1800	880	-	
		hardenable	hardened	100	23				540	380	-	540	380	-	
	Cast aluminium alloys	$\leq 12\%$ Si, cannot be hardened		75	24				500	270	-	500	270	-	
		$\leq 12\%$ Si, hardenable	hardened	90	25				320	170	-	320	170	-	
		$> 12\%$ Si, cannot be hardened		130	26				290	150	-	290	150	-	
	Copper and copper alloys (bronze/brass)	machining steel, PB > 1%		110	27				660	320	-	660	320	-	
		CuZn, CuSnZn		90	28				330	300	-	330	300	-	
	CuSn, Pb-free copper, electrolytic copper		100	29				220	175	-	220	175	-		
S	Heat-resistant alloys	Fe-based alloys	annealed	200	30							60	45	-	
			hardened	280	31								55	40	-
		Ni or Co bass	annealed	250	32								55	40	-
			hardened	350	33								50	35	-
		cast	320	34								50	35	-	
	Titanium alloys	pure titanium		R _m 400	35							95	60	-	
	α and β alloys	hardened		R _m 1050	36						75	40	-		
H	Hardened steel		hardened and tempered	55 HRC	37										
			hardened and tempered	60 HRC	38										
	Hard cast iron		cast	400	39										
	Hardened cast iron		hardened and tempered	55 HRC	40										
X	Non-metallic materials	Thermoplastics			41										
		Thermosetting plastics			42										
		Plastic, glass-fibre reinforced GFRP			43										
		Plastic, carbon fibre reinforced CFRP			44										
		Graphite			45										
		Wood			46										

Note: The given cutting values are guide values, which were determined under ideal conditions.
 The values have to be adapted in individual cases.
 For examples of material for cutting tool groups view page D11.

A Turning
B Milling
C Drilling
D Technical Information
E Index

Starting values for cutting speed v_c [m/min]																								
HC (PVD)																								
YBS103			YBG105			YB9320			YBG205			YPD201			YNG151C			YNG151			YNT251			
Feed rate [mm]			Feed rate [mm]			Feed rate [mm]			Feed rate [mm]			Feed rate [mm]			Feed rate [mm]			Feed rate [mm]						
0,1	0,2	0,4	0,1	0,2	0,4	0,1	0,2	0,4	0,1	0,2	0,4	0,1	0,3	0,6	0,1	0,2	0,4	0,1	0,2	0,4	0,1	0,2	0,4	
															470	320	-	470	320	-	470	320	-	
															400	250	-	400	250	-	400	250	-	
															300	200	-	300	200	-	300	200	-	
															290	180	-	290	180	-	290	180	-	
															245	150	-	245	150	-	245	150	-	
															370	220	-	370	220	-	370	220	-	
															255	160	-	255	160	-	255	160	-	
															200	140	-	200	140	-	200	140	-	
															185	130	-	185	130	-	185	130	-	
															285	180	-	285	180	-	285	180	-	
															150	90	-	150	90	-	150	90	-	
	305	245	205	305	245	205	305	245	206	270	205	165	360	290	200									
	150	125	100	150	125	100	160	130	110	145	125	100	190	155	110									
	200	165	145	200	165	145	210	180	155	195	165	145	250	210	150									
	160	130	115	160	130	115	170	140	120	155	130	115	200	165	120									
																390	330	255	390	330	255	390	330	255
																355	310	245	355	310	245	355	310	245
																330	270	200	330	270	200	330	270	200
																310	270	210	310	270	210	310	270	210
																260	220	160	260	220	160	260	220	160
																210	170	120	210	170	120	210	170	120
	70	50	-	60	45	-	50	35	-	50	-	-	-	50	35									
	60	45	-	55	40	-	45	30	-	45	-	-	-	45	30									
	60	45	-	55	40	-	45	30	-	45	-	-	-	45	30									
	66	40	-	50	35	-	40	-	-	40	-	-	-	40	-									
	66	40	-	50	35	-	40	-	-	40	-	-	-	40	-									
	100	65	-	95	60	-	75	60	-	70	-	-	-	75	60									
	75	50	-	75	40	-	55	40	-	45	-	-	-	55	40									

HC Coated carbide
 HT Uncoated carbide, primary component (TiC) or (TiN), cermet
 HW Uncoated carbide, primary component (WC)
 BL Cubic boron nitride with low BN content
 BH Cubic boron nitride with high BN content
 CN Si₃N₄ ceramic
 CM Mixed ceramic
 HC₁ Coated cermet
 BC CBN with coating
 CC Coated cutting ceramic
 CR Cutting ceramic, primary component aluminium oxide (Al₂O₃), reinforced
 DP Polycrystalline diamond

A
 Turning
B
 Milling
C
 Drilling
D
 Technical Information
E
 Index



Turning insert, positive

	Material group	Composition / structure / heat treatment		Brinell hardness HB	Machining group	Starting values for cutting speed v_c [m/min]								
						HW						BL		
						YD101			YD201			YCB112		
						Feed rate [mm]			Feed rate [mm]			Feed rate [mm]		
					0,1	0,2	0,3	0,1	0,2	0,3	0,1	0,2	0,3	
P	Unalloyed steel	approx. 0,15 % C	annealed	125	1									
		approx. 0,45 % C	annealed	190	2									
		approx. 0,45 % C	tempered	250	3									
		approx. 0,75 % C	annealed	270	4									
		approx. 0,75 % C	tempered	300	5									
	Low-alloyed steel		annealed	180	6									
			tempered	275	7									
			tempered	300	8									
			tempered	350	9									
	High-alloyed steel and high-alloyed tool steel		annealed	200	10									
			hardened and tempered	325	11									
M	Stainless steel	ferritic/martensitic	annealed	200	12									
		martensitic	tempered	240	13									
		austenitic	quench hardened	180	14									
		austenitic-ferritic		230	15									
K	Grey cast iron	perlitic/ferritic		180	16									
		perlitic (martensitic)		260	17									
	Cast iron with spheroidal graphite	ferritic		160	18									
		perlitic		250	19									
	Malleable cast iron	ferritic		130	20									
		perlitic		230	21									
N	Aluminium wrought alloys	cannot be hardened		60	22	1550	1050	700	1550	1050	700			
		hardenable	hardened	100	23	450	320	200	450	320	200			
	Cast aluminium alloys	$\leq 12\%$ Si, cannot be hardened		75	24	400	270	150	400	270	150			
		$\leq 12\%$ Si, hardenable	hardened	90	25	250	170	95	250	170	95			
		$> 12\%$ Si, cannot be hardened		130	26	230	150	85	230	150	85			
	Copper and copper alloys (bronze/brass)	machining steel, PB > 1%		110	27	550	370	170	550	370	170			
		CuZn, CuSnZn		90	28	260	210	160	260	210	160			
	CuSn, Pb-free copper, electrolytic copper		100	29	190	145	95	190	145	95				
S	Heat-resistant alloys	Fe-based alloys	annealed	200	30	55	30	-	55	30	-	-	-	-
			hardened	280	31	55	25	-	55	25	-	-	-	-
		Ni or Co bass	annealed	250	32	45	25	-	45	25	-	180	160	140
			hardened	350	33	35	20	-	35	20	-	160	140	120
		cast	320	34	40	20	-	40	20	-	120	100	80	
Titanium alloys	pure titanium		R _m 400	35	60	40	-	60	40	-	-	-	-	
	α and β alloys	hardened	R _m 1050	36	30	-	-	30	-	-	-	-	-	
H	Hardened steel		hardened and tempered	55 HRC	37							220	170	130
			hardened and tempered	60 HRC	38							200	160	120
	Hard cast iron		cast	400	39							200	150	100
	Hardened cast iron		hardened and tempered	55 HRC	40							200	150	100
X	Non-metallic materials	Thermoplastics			41									
		Thermosetting plastics			42									
		Plastic, glass-fibre reinforced GFRP			43									
		Plastic, carbon fibre reinforced CFRP			44									
		Graphite			45									
		Wood			46									

Note: The given cutting values are guide values, which were determined under ideal conditions. The values have to be adapted in individual cases. For examples of material for cutting tool groups view page D11.

A Turning
B Milling
C Drilling
D Technical Information
E Index

A

Turning

B

Milling

C

Drilling

D

Technical Information

E

Index

Starting values for cutting speed v_c [m/min]																							
BL									BC									BH			DP		
YCB113			YCB121			YCB131			YCB113C			YCB121C			YCB131C			YCB215			YCD421		
Feed rate [mm]			Feed rate [mm]			Feed rate [mm]			Feed rate [mm]			Feed rate [mm]			Feed rate [mm]			Feed rate [mm]					
0,1	0,2	0,3	0,1	0,2	0,3	0,1	0,2	0,3	0,1	0,2	0,3	0,1	0,2	0,3	0,1	0,2	0,3	0,1	0,2	0,3	0,05	0,2	0,4
																		1500	980	400			
																		1250	800	320			
																		-	-	-			
																		300	200	100			
																		-	-	-			
																		300	200	100			
																					2500	2000	250
																					2500	2000	250
																					2500	2000	250
																					2500	2000	250
																					1000	800	100
																					650	530	70
																					650	530	70
																					400	330	40
							-	-	-														
							-	-	-														
							160	140	120														
							140	120	100														
							120	100	80														
							-	-	-														
							-	-	-														
	240	180	140	220	170	130	160	120	100	240	180	140	220	170	130	160	120	100					
	220	180	140	200	160	120	150	120	100	220	180	140	200	160	120	150	120	100					
	250	150	100	200	150	100	180	120	100	250	150	100	200	150	100	180	120	100					
	200	150	100	200	150	100	150	120	100	200	150	100	200	150	100	150	120	100					

- HC Coated carbide
- HT Uncoated carbide, primary component (TiC) or (TiN), cermet
- HW Uncoated carbide, primary component (WC)
- BL Cubic boron nitride with low BN content
- BH Cubic boron nitride with high BN content
- CN Si3N4 ceramic
- CM Mixed ceramic
- HC₁ Coated cermet
- BC CBN with coating
- CC Coated cutting ceramic
- CR Cutting ceramic, primary component aluminium oxide (Al₂O₃), reinforced
- DP Polycrystalline diamond



PARTING & GROOVING

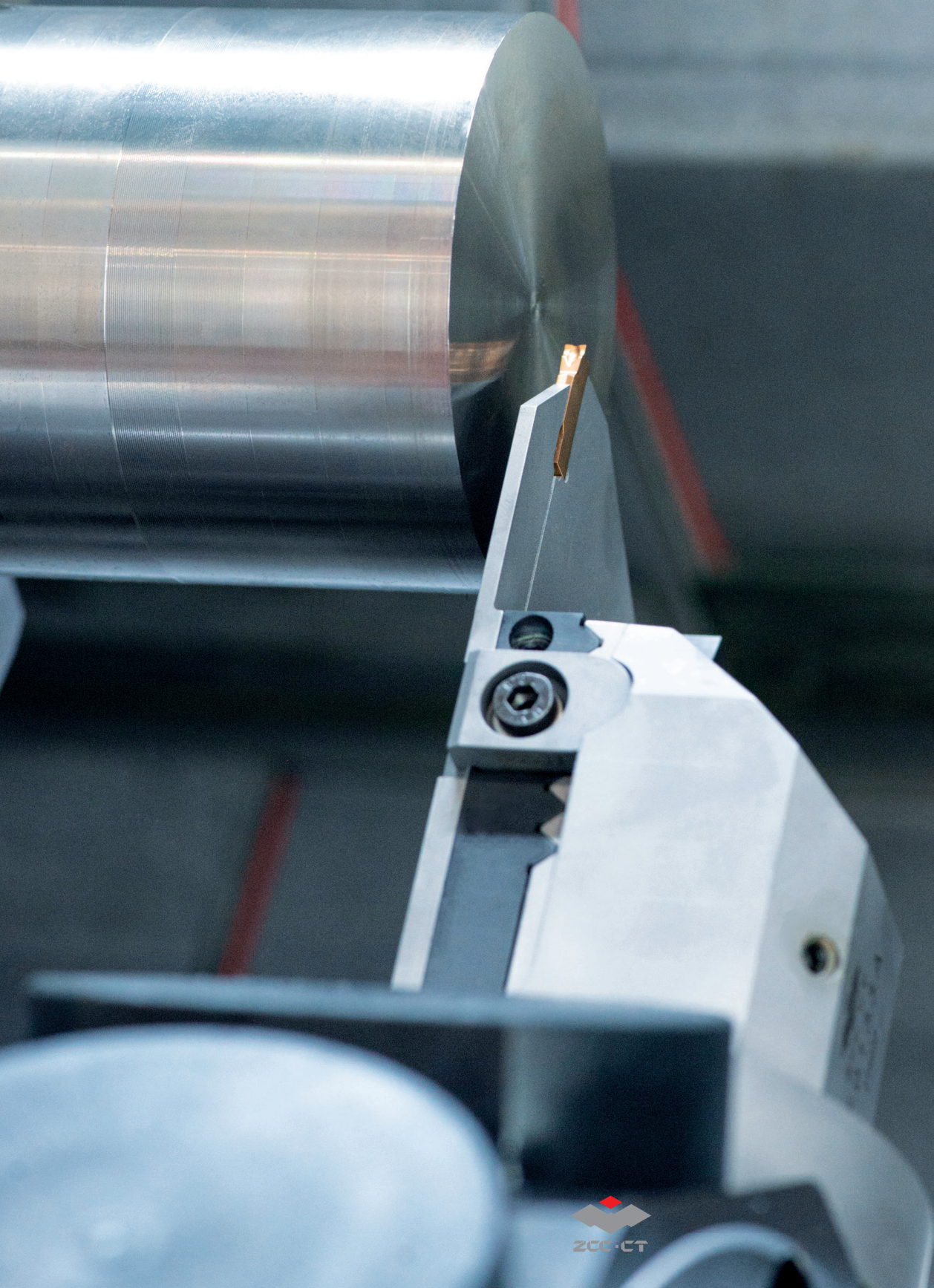

A

Turning

B

Milling

C

Drilling

DTechnical
Information**E**

Index



Parting & grooving

Product overview	A382-A383
System overview	A384-A385
Tool holder orientation	A386-A387
Chip breaker overview	A388-A389
Application fields of chip breakers	A390-A391
Grade overview	A392-A393
Application fields of grades	A394-A397
System code – inserts	A398
Inserts	A399-A415
System code – inserts – QC series	A416
Inserts – QC series	A417-A421
System code – tool holders	A422-A424
Tool holders	A425-A445
Precision monoblock tool holder	A446-A451
System code – tool holders – QC series	A452
Tool holders – QC series	A453-A455
Recommended cutting data	A456-A457
Technical Information	A510
Special tools	A513

Parting & grooving inserts

Double sided



ZT*D-MM

2-8

A399



ZT*D-MG

2.5-6

A404



ZT-EG**

1-6.5

A407



ZP*D-MG

2.5-6

A400



ZP*D-MG-R/L

2.35-2.85

A401

Width

Page



ZR*D-MG

2.5-6

A410



ZR*D-EG

3-6

A411



ZR*D-LH

6-8

A414



ZILD-LC

8

A415

Width

Page

Single sided



ZT*S-MM

2.5-6

A406



ZT*S-MG

5-6

A405



ZP*S-MG

2.5-6

A402

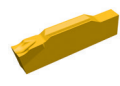

ZP*S-MG-R/L

2.5-3

A403

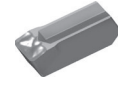

ZIMF-NM

3-6

A412



ZIGQ-NM

3-6

A413

Width

Page

Three cutting edges



QCR/L**

0.75-4.8

A417



QCR/L***R**

1-4

A420

Width

Page

A

Turning

B

Milling

C

Drilling

D



Technical Information

E

Index

External tool holders

						
GQC**R/L	QE**R/L	QE*S**N	QE*S**N-1	QE*SN30	QE*SR/L	QECDR/L
A453	A425	A431	A432	A427	A430	A428

						
QF**R/L	QF**RR/LL	QF*DR/L	QF*SRR/LL	QFHSDR/L	QX*DR/L	QZS*
A434	A436	A439	A438	A441	A429	A433

		
QE**R/L-DGC	QE**R/L-DGSC	QE**R/L-SC
A446	A448	A449

Boring bars

		
C***-Q*DR/L	C40X-Q*DR/L	S*K-QC**R/L
A444	A443	A454

A	Turning
B	Milling
C	Drilling
D	Technical Information
E	Index

A

Turning

B

Milling

C

Drilling

D

Technical Information

E

Index

	System information	Groove width S	Groove depth a, max.	Grooving	Parting	Turning	Page
QE system	<ul style="list-style-type: none"> System for radial parting off and grooving and turning Tool holders available for internal and external machining Available with targeted cooling and direct supply of coolant via the shank Inserts with one or two cutting edges Inserts for precision grooving available 	2,0–6,0 mm	max 30,0 mm	✓	✓	✓	<ul style="list-style-type: none"> ■ A425 ● A444
QZ and QE system	<ul style="list-style-type: none"> System for radial parting off and grooving Insert holder and clamping block in one Self-clamping system Inserts with one cutting edge Can be used in a wide range of applications 	2,5–6,0 mm	max 60,0 mm	✓	✓	–	■ A431
QF system	<ul style="list-style-type: none"> System for radial grooving and turning Penetration diameter range of Ø 48–400 mm Screw clamped for maximum stability Inserts with two cutting edges Tool holders available in a neutral design or with a 90° offset Right base for M3 Left base for M4 	2,0–6,0 mm	max 22,0 mm	✓	–	✓	■ A434
QX system	<ul style="list-style-type: none"> System for undercutting Shank holder with 45° approach angle Screw clamped for maximum stability For grooving inserts with two cutting edges For turning operations and machining undercuts and recesses. Can also be used in copy turning applications 	3,0–6,0 mm	max 4,0 mm	✓	–	✓	■ A429

■ External tool holders
● Boring bars

	System information	Groove width S	Groove depth a, max.	Grooving	Parting	Turning	Page
C*X-Q system	<ul style="list-style-type: none"> Special system for machining aluminium wheels Boring bar with 15° approach angle Screw clamped for maximum stability For grooving inserts with two cutting edges Penetration diameter range from Ø 160 mm Special chip breakers for aluminium machining 	6,0–8,0 mm	max 80,0 mm	–	–	✓	● A443
QE*S*N system	<ul style="list-style-type: none"> System specially designed for heat-resistant alloys Special chip breakers for heat-resistant alloys Screw clamped for maximum stability For grooving inserts with one cutting edge 	3,0–6,0 mm	max 22,0 mm	✓	–	✓	■ A430
QC system	<ul style="list-style-type: none"> System for precision grooving Tool holders available for external and internal machining Tangential screw clamping for high stability and rigidity Three cutting edges for high efficiency Precision-ground grooving inserts with high tolerances High repeatability even after replacing insert Grooving inserts with straight or round cutting edge Special feature with internal machining: right tool holder + left grooving insert / left tool holder + right grooving insert 	0,5–4,8 mm	max 5,0 mm	✓	–	–	■ A453 ● A454

■ External tool holders
● Boring bars

A

Turning

B

Milling

C

Drilling

D

Technical Information

E

Index

Tool holders for axial machining

Tool holder	Tool holder orientation
<p>A</p> <p>Turning</p> <p>QFFD****L**_**H</p>	 <p>CW/M3</p>
<p>B</p> <p>Milling</p> <p>QFFD****R**_**H</p>	 <p>CCW/M4</p>
<p>C</p> <p>Drilling</p> <p>QFFD****LL**_**H</p>	 <p>CCW/M4</p>
<p>D</p> <p>Technical Information</p> <p>QFFD****L**_**L</p>	 <p>CCW/M4</p>
<p>E</p> <p>Index</p> <p>QFFD****R**_**L</p>	 <p>CW/M3</p>

Notes

.....

.....

.....

.....

.....

.....

.....

.....

.....

.....

.....

.....

.....

.....

.....

.....

.....

.....

.....

.....

.....

.....

.....

.....

.....

A
Turning

B
Milling

C
Drilling

D
Technical Information

E
Index

A

Grooving

MM P M K S



Turning

Sintered chip breaker with straight cutting edge for general machining of steel, stainless steel, cast iron and difficult-to-machine materials. Can be used for grooving, turning and parting off.

B

MG P M K S

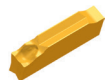
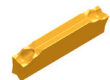

Milling

Sintered chip breaker for general machining of steel, stainless steel, cast iron and difficult-to-machine materials. Can be used for grooving, turning and parting off.

C

MG P M K S



Drilling

Universal chip breaker with round profile for general machining of steel, stainless steel and cast iron. Suitable for grooving and profiling.

D

EG M P S



Technical Information

Ground precision chip breaker for grooving and turning applications. Suitable for machining of stainless steel. E-tolerance for high repeatability.

EG M P S



Ground precision chip breaker with round profile for grooving and turning applications. Suitable for machining of stainless steel. E-tolerance for high repeatability.

E

NM S

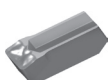

Index

Special chip breaker for machining of heat-resistant materials.

Grooving

LC

N



Ground chip breaker for profile and turning applications of non-ferrous metals.

LH

N



Ground chip breaker for profile and turning applications of non-ferrous metals.

A

Turning

B

Milling

C

Drilling

D

Technical Information

E

Index

Parting & grooving Application fields of chip breakers

A Turning
B Milling
C Drilling
D Technical Information
E Index

Chip breaker	Application	P	M	K	N	S	H	Feed	Cutting edge design
ZT****-MM	Parting & grooving ✓								
	Turning ✓	✓	✓	✓		✓			
ZP****-MG	Parting & grooving ✓								
	Turning -	✓	✓	✓		✓			
ZT****-MG	Parting & grooving ✓								
	Turning ✓	✓	✓	✓		✓			
ZR****-MG	Parting & grooving ✓								
	Turning ✓	✓	✓	✓		✓			
ZT****-EG	Parting & grooving ✓								
	Turning ✓	✓	✓	✓		✓			
ZR****-EG	Parting & grooving ✓								
	Turning ✓	✓	✓	✓		✓			
ZI****-NM	Parting & grooving ✓								
	Turning ✓		✓		✓	✓			

✓ Very suitable ✓ Suitable

■ Parting & grooving
■ Turning

Chip breaker	Application	P	M	K	N	S	H	Feed	Cutting edge design
ZR****-LH	Parting & grooving ✓				✓	✓			Round profile
	Turning ✓								
ZI****-LC	Parting & grooving ✓				✓	✓			Round profile
	Turning ✓								

✓ Very suitable

✓ Suitable

■ Parting & grooving

■ Turning

A	Turning
B	Milling
C	Drilling
D	Technical Information
E	Index

A
Turning

B
Milling

C
Drilling

D
Technical Information

E
Index

Parting & grooving

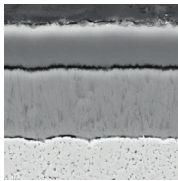
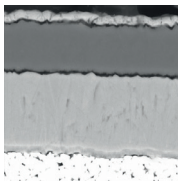
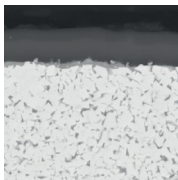
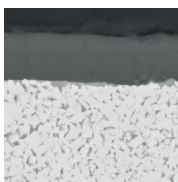
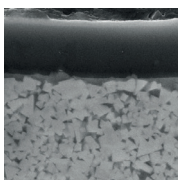
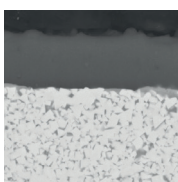
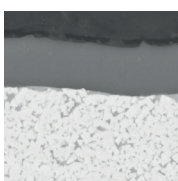
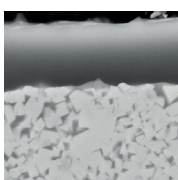
Grade	ISO	Micro structure	Grade description
YBC252	P20 - P35		CVD coated P20–P35 carbide grade for medium operation to roughing of steel and casting steel. Optimal performance of wear resistance and toughness for a wide application field.
YBC251	P20 - P35		CVD coated P20–P35 carbide grade for medium operation to roughing of steel and casting steel in lower cutting speed.
YBG105	S05 - S20		PVD multilayer coated S05–S20 carbide substrate for finishing to medium application of super alloy material but also stainless steel. Good wear resistance and thermal stability in a wide application field.
YBG102	S05 - S15		PVD coated S05–S15 carbide substrate for finishing to medium application of super alloy material, stainless steel and aluminum. Good wear resistance in a wide application field.
YB9320	P10 - P30 M10 - M25		PVD multilayer coated P10–P30/M10–M25 carbide substrate for finishing to medium machining of stainless steel, super alloys and steel (grooving/milling). Optimised coating stability for higher wear resistance and thermal stability in a wide range of applications.
YBG205	P10 - P30 M20 - M40 S15-S25		PVD multilayer coated P10–P30/M20–M40/S15–S25 carbide substrate for finishing to medium machining of stainless steel, super alloys and steel (milling). Excellent wear resistance and thermal stability in a wide range of applications.
YBG202	P10 - P30 M10 - M25		PVD coated P10–P30/M10–M25 carbide substrate for finishing to medium application of stainless steel and steel (milling). Good wear resistance in a wide application field.
YBG302	P15 - P30 M25 - M40		PVD coated P15–P30/M25–M40 carbide substrate for medium roughing application of stainless steel and steel (milling). Good wear resistance and toughness.

Parting & grooving

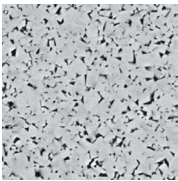
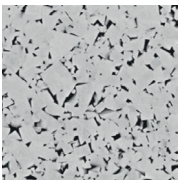
Grade	ISO	Micro structure	Grade description
YD101	K05 - K20 N05 - N20		Uncoated K05–K20/N05–N20 carbide substrate for fine to medium application in aluminum and other material.
YD201	K10 - K30 N10 - N30		Uncoated K10–K30/N10–N30 carbide substrate for medium application in aluminum and other material.

A

Turning

B

Milling

C

Drilling

DTechnical
Information**E**

Index

CVD coated carbide grades for steel

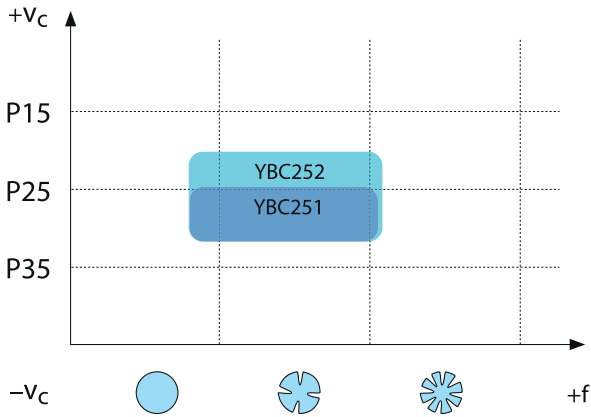

PVD coated carbide grades for stainless steel

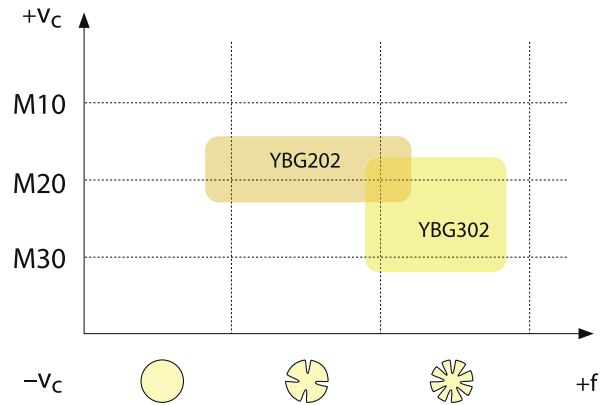
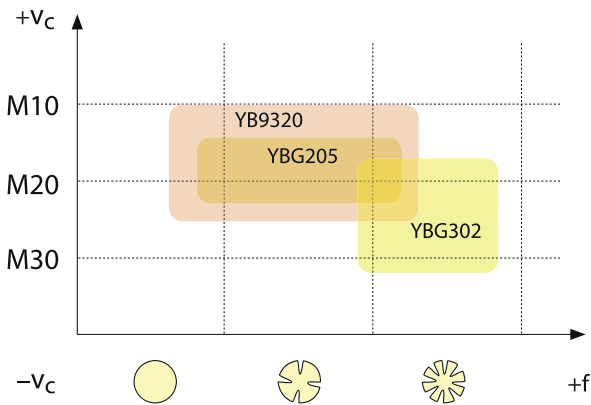

PVD coated carbide grades for superalloys

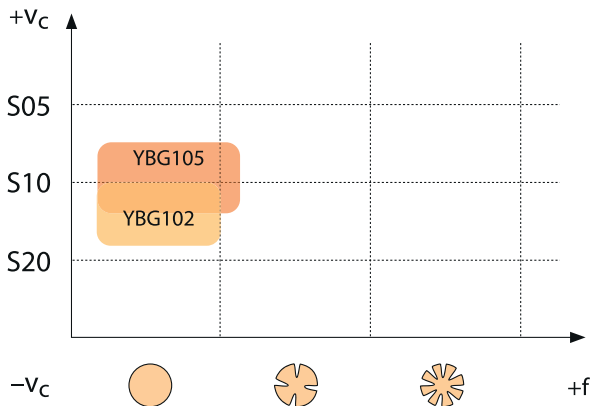

A

Turning

B

Milling

C

Drilling

D

Technical Information

E

Index

Carbide grades for non-ferrous metals

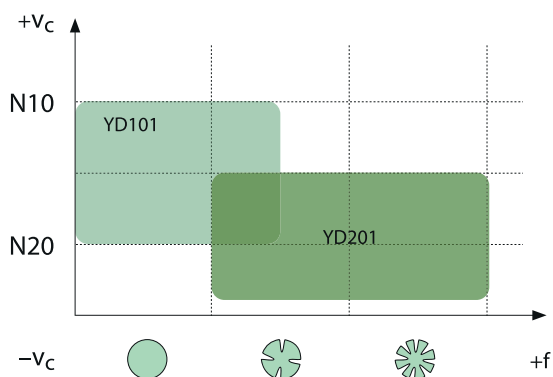

A

Turning

B

Milling

C

Drilling

D

Technical
Information

E

Index

Application fields of grades – parting & grooving

	ISO	HC ¹ (CVD)	HC ¹ (PVD)	HT	HC ²	Ceramic	HW	CBN	PCD
A Turning	P01								
	P10								
	P20	YBC251 YBC252							
	P30								
	P40								
B Milling	M01								
	M10								
	M20		YBG202 YBG205 YB9320 YBG302						
	M30								
	M40								
C Drilling	K01								
	K10								
	K20								
	K30								
D Technical Information	N01						YD101 YD102		
	N10								
	N20								
	N30								
E Index	S01								
	S10		YBG102 YBG105						
	S20								
	S30								
F Index	H01								
	H10								
	H20								
	H30								

P	Steel
M	Stainless steel
K	Cast iron

N	Non-ferrous metals
S	Heat-resistant alloys
H	Hardened materials

HC ¹	Coated carbide
HT	Uncoated cermet
HC ²	Coated cermet
HW	Uncoated carbide

Notes

Dotted lines for writing notes.

A

Turning

B

Milling

C

Drilling

D

Technical
Information

E

Index

ZP G D 04 04 – M G

1 2 3 4 5 6 7

A

Turning

B

Milling

C

Drilling

D

Technical Information

E

Index

Application	
Code	Description
ZP	Parting
ZT	Grooving & turning
ZR	Form turning

1

Insert seat size [mm]	
Groove width	
Code	Description
B	2,0
E	2,5
F	3,0
G	4,0
H	5,0
K	6,0
L	8,0

2

No. of cutting edges	
Code	Description
S	Single
D	Double

3

Insert thickness S [mm]	
	
Code	S
02	2,0
025	2,5
03	3,0
04	4,0
05	5,0
06	6,0
08	8,0

4

Nose radius r [mm]	
	
Code	r
02	0,2
03	0,3
04	0,4
08	0,8



5

Tolerance class [mm]	
Code	Description
M	±0,13
E	±0,025











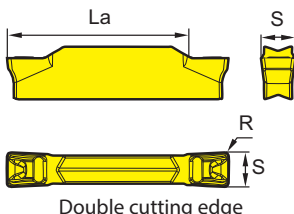









6

Chip breaker	
Code	Description
G	General chip breaker
F	Special chip breaker
M	Straight edge

7

-  Ideal machining conditions
-  Normal machining conditions
-  Unfavourable machining conditions



Parting inserts

ZT** parting & grooving insert (double sided)						HC ¹ (CVD)		HC ¹ (PVD)			HW		
 <p>Double cutting edge</p>	P	 						   					
	M							   					
	K												
	N										 		
	S								    				
	H												
ISO	R \pm 0.1	La max	S	f	YBC252 YBC251			YBG105 YBG102 YB9320 YBG205 YBG202 YBG302			YD101 YD201		
	ZTBD02002-MM	0.2	13	2	0,02-0,07								
	ZTED02503-MM	0.3	17	2.5	0,03-0,1								
	ZTFD0303-MM	0.3	17	3	0,04-0,13								
	ZTGD0404-MM	0.4	22	4	0,06-0,18								
	ZTHD0504-MM	0.4	22	5	0,08-0,23								
	ZTKD0608-MM	0.8	22	6	0,12-0,27								
	ZTLD0808-MM	0.8	28	8	0,13-0,29								

● Ex stock ○ On demand

HC¹ Coated carbide
HW Uncoated carbide

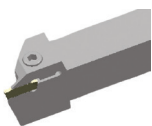
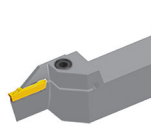
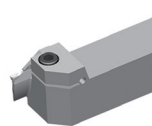
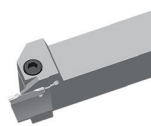
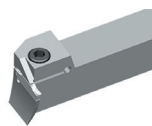
Tool holders

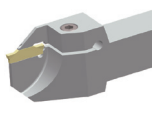
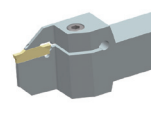
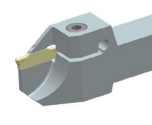
QE*D*R/L	QF*D*R/L-H	QF*D*LL-H	QF*D*RR-H	QF*D*R/L-L	*-QBDR/L	C***-Q*DR/L
						
A425	A434	A436	A436	A439	A444	A444
QE*D*R/L-DGC	QE*D*R/L-DGSC	QE*D*R/L-SC				
						
A446	A448	A449				

System code > A398

Grade selection > A394

Technical info > A501

Cutting data > A456



A

Turning

B

Milling

C

Drilling

D

Technical Information



E







Index

A

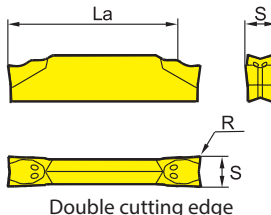
Turning

Parting inserts

-  Ideal machining conditions
-  Normal machining conditions
-  Unfavourable machining conditions

Parting & grooving insert (double sided)		HC ¹ (CVD)	HC ¹ (PVD)	HW
	P			
	M			
	K			
	N			
	S			
	H			

B

Milling

ISO	R±0.1	La max	S±0.10	f	YBC252	YBC251	YBG105	YBG102	YB9320	YBG205	YBG202	YBG302	YD101	YD201
	ZPED02502-MG	0.2	17	2.5	0,03-0,1	●			●	○	●			
	ZPFD0302-MG	0.2	17	3	0,04-0,13	●			●	○	●			
	ZPGD0402-MG	0.2	22	4	0,07-0,18	●			●		●		○	
	ZPHD0503-MG	0.3	22	5	0,1-0,24						○	●		
	ZPKD0604-MG	0.4	22	6	0,12-0,29	○					○	●		

● Ex stock ○ On demand

HC¹ Coated carbide
HW Uncoated carbide

C

Drilling

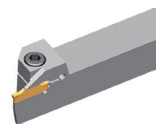
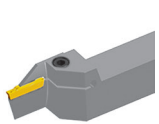
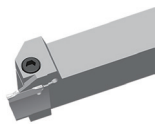
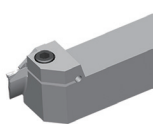
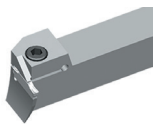
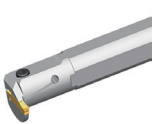
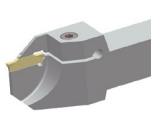
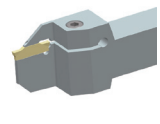
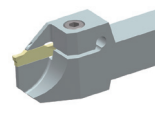
Tool holders						
QE*D*R/L	QF*D*R/L-H	QF*D*RR-H	QF*D*LL-H	QF*D*R/L-L	C***-Q*DR/L	QE*D*R/L-DGC
						
A425	A434	A436	A436	A439	A444	A446
QE*D*R/L-DGSC	QE*D*R/L-SC					
						
A448	A449					

D

Technical Information

E

Index



System code > A398











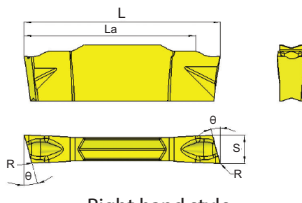







Grade selection > A394

Technical info > A501

Cutting data > A456

Parting inserts

-  Ideal machining conditions
-  Normal machining conditions
-  Unfavourable machining conditions

ZT** parting & grooving insert (double sided)								HC ¹ (CVD)		HC ¹ (PVD)			HW			
 <p>Right hand style</p>	P															
	M															
	K															
	N															
	S															
	H															
ISO	La max	L	S	θ	R	f	YBC252	YBC251	YBG105	YBG102	YB9320	YBG205	YBG202	YBG302	YD101	YD201
	ZPED02502-MG-6L	17	20	2.35	6°	0.2	0,03-0,08							●		
	ZPED02502-MG-6R	17	20	2.35	6°	0.2	0,03-0,08				●			●		
	ZPED02502-MG-15L	17	20	2.35	15°	0.2	0,03-0,05							○		
	ZPED02502-MG-15R	17	20	2.35	15°	0.2	0,03-0,05							○	○	
	ZPFD0302-MG-6L	17	20	2.85	6°	0.2	0,04-0,1				●	○	●			
	ZPFD0302-MG-6R	17	20	2.85	6°	0.2	0,04-0,1				●	○	○			
	ZPFD0302-MG-15L	17	20	2.85	15°	0.2	0,04-0,08						○	○		
	ZPFD0302-MG-15R	17	20	2.85	15°	0.3	0,04-0,08					●	○			

● Ex stock ○ On demand

HC¹ Coated carbide
HW Uncoated carbide

Tool holders

QE*D*R/L

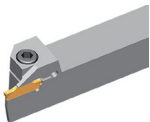

A425

System code > A398

Grade selection > A394

Technical info > A501

Cutting data > A456



A

Turning

B

Milling

C

Drilling

D

Technical Information



E











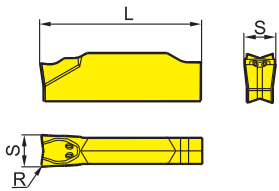



Index

A

Turning

Parting inserts

-  Ideal machining conditions
-  Normal machining conditions
-  Unfavourable machining conditions

Parting & grooving insert (single sided)					HC ¹ (CVD)		HC ¹ (PVD)			HW	
 <p>Single cutting edge</p>	P										
	M										
	K										
	N										
	S										
	H										

B

Milling



ISO	R±0.1	S±0.10	f	YBC252	YBC251	YBG105	YBG102	YB9320	YBG205	YBG202	YBG302	YD101	YD201
ZPES02502-MG	0.2	2.5	0,03-0,1					○	○	●			
ZPFS0302-MG	0.2	3	0,04-0,13	●				●		●			
ZPGS0402-MG	0.2	4	0,07-0,18	○						○	●	○	
ZPGS0402-MG-25	0.2	4	0,07-0,18					●					
ZPHS0503-MG	0.3	5	0,1-0,24						○	●			
ZPHS0503-MG-25	0.3	5	0,1-0,24					●					
ZPKS0604-MG	0.4	6	0,12-0,29							○	●		
ZPKS0604-MG-25	0.4	6	0,12-0,29					●					

● Ex stock ○ On demand
Single sided inserts only for parting blades

HC¹ Coated carbide
HW Uncoated carbide

C

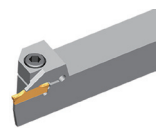
Drilling

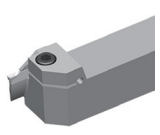
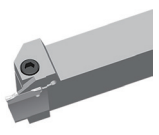
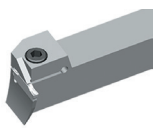
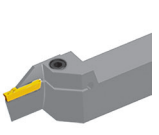
Tool holders					
QE*S*R/L	QZ**+QE**	QF*S*LL-H	QF*S*RR-H	QF*S*R/L-L	QF*S*R/L-H
					
A427	A432	A438	A438	A441	A442

D

Technical Information

E



Index

System code > A398











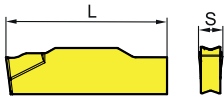







Grade selection > A394

Technical info > A501

Cutting data > A456

-  Ideal machining conditions
-  Normal machining conditions
-  Unfavourable machining conditions

Parting inserts

Parting & grooving insert (single sided)							HC ¹ (CVD)		HC ¹ (PVD)			HW					
  Single cutting edge	P																
	M																
	K																
	N																
	S																
H																	
ISO	R±0.1	L	S±0.10	θ	f	YBC252	YBC251			YBG105	YBG102	YB9320	YBG205	YBG202	YBG302	YD101	YD201
	ZPES02502-MG-6L	0.2	19.9	2.5	6°	0,03-0,08							●				
	ZPES02502-MG-6R	0.2	19.9	2.5	6°	0,03-0,08							●				
	ZPFS0302-MG-6L	0.2	19.9	3	6°	0,04-0,1							●				
	ZPFS0302-MG-6R	0.2	19.9	3	6°	0,04-0,1							●				

● Ex stock ○ On demand

Single sided inserts only for parting blades

HC¹ Coated carbide
HW Uncoated carbide

Tool holders

QZ**+QE**



A432

System code > A398

Grade selection > A394



Technical info > A501











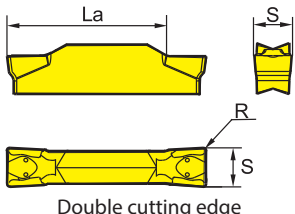













Cutting data > A456

A

Turning

Parting inserts

-  Ideal machining conditions
-  Normal machining conditions
-  Unfavourable machining conditions



Parting & grooving insert (double sided)						HC ¹ (CVD)		HC ¹ (PVD)			HW	
	P	 						   				
	M							   				
	K											
	N										 	
	S							   				
	H											
ISO	R±0.1	La max	S±0.10	f	YBC252 YBC251		YBG105 YBG102 YB9320 YBG205 YBG202 YBG302		YD101 YD201			
	ZTED02503-MG		17	2.5	0,03-0,11							
	ZTFD0303-MG		17	3	0,04-0,14							
	ZTGD0402-MG		22	4	0,07-0,2							
	ZTGD0404-MG		22	4	0,07-0,2							
	ZTHD0504-MG		22	5	0,10-0,25							
	ZTKD0604-MG		22	6	0,13-0,30							
	ZTKD0608-MG		22	6	0,13-0,30			 				

● Ex stock ○ On demand

HC¹ Coated carbide
HW Uncoated carbide

C

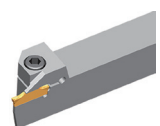
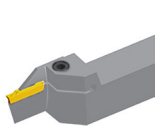
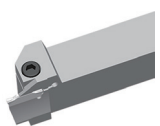
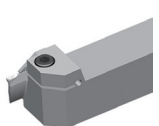
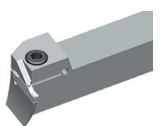
Drilling

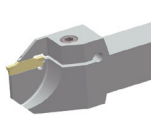
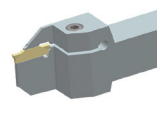
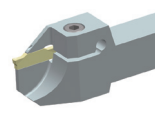
Tool holders						
QE*D*R/L	QF*D*R/L-H	QF*D*RR-H	QF*D*LL-H	QF*D*R/L-L	C***-Q*DR/L	QE*D*R/L-DGC
						
A425	A434	A436	A436	A439	A444	A446
QE*D*R/L-DGSC	QE*D*R/L-SC					
						
A448	A449					

D

Technical Information

E



Index

System code > A398











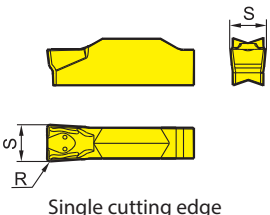







Grade selection > A394

Technical info > A501

Cutting data > A456



-  Ideal machining conditions
-  Normal machining conditions
-  Unfavourable machining conditions

Parting inserts

Parting & grooving insert (single sided)					HC ¹ (CVD)		HC ¹ (PVD)			HW	
 <p>Single cutting edge</p>	P										
	M										
	K										
	N										
	S										
	H										
ISO	R±0.1	S±0.10	f	YBC252 YBC251			YBG105 YBG102 YB9320 YBG205 YBG202 YBG302			YD101 YD201	
	ZTHS0504-MG	0.4	5	0,10-0,25				○	○	●	
	ZTKS0608-MG	0.8	6	0,13-0,30					○	●	

● Ex stock ○ On demand

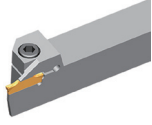
HC¹ Coated carbide
HW Uncoated carbide

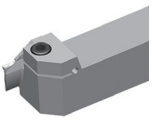
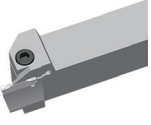
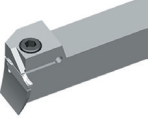
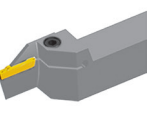
Tool holders					
QE*S*/L	QZ**+QE**	QF*S*LL-H	QF*S*RR-H	QF*S*/L-L	QF*S*/L-H
					
A427	A431	A438	A438	A441	A442

System code > A398

Grade selection > A394

Technical info > A501

Cutting data > A456



A

Turning

B

Milling

C

Drilling

D

Technical Information



E











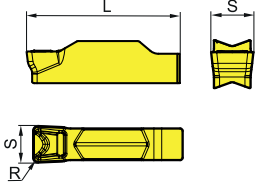







Index

A

Turning

Parting inserts

-  Ideal machining conditions
-  Normal machining conditions
-  Unfavourable machining conditions

Parting & grooving insert (single sided)						HC ¹ (CVD)		HC ¹ (PVD)			HW								
 <p>Single cutting edge</p>						P													
						M													
						K													
						N													
						S													
						H													
ISO						R±0.1	L	S±0.10	f	YBC252 YBC251			YBG105 YBG102 YB9320 YBG205 YBG202 YBG302	YD101 YD201					
	ZTES02503-MM	0.3	19.9	2.5	0,03-0,1														
	ZTFS0303-MM	0.3	19.9	3	0,04-0,13														
	ZTGS0404-MM-25	0.4	24.6	4	0,06-0,18														
	ZTHS0504-MM-25	0.4	24.6	5	0,08-0,23														
	ZTKS0608-MM-25	0.8	24.6	6	0,12-0,27														

● Ex stock ○ On demand

HC¹ Coated carbide
HW Uncoated carbide

B

Milling

C



Drilling

D

Technical Information

E

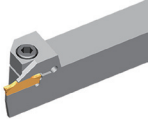
Index

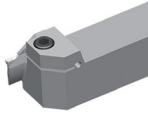
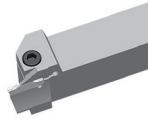
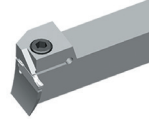
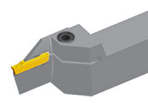
Tool holders					
QE*S*R/L	QZ**+QE**	QF*S*LL-H	QF*S*RR-H	QF*S*R/L-L	QF*S*R/L-H
					
A427	A432	A438	A438	A441	A442

System code > A398

Grade selection > A394

Technical info > A501

Cutting data > A456

- Ideal machining conditions
- Normal machining conditions
- Unfavourable machining conditions

Parting inserts

Parting & grooving insert (double sided)						HC ¹ (CVD)		HC ¹ (PVD)				HW					
						P											
						M											
						K											
						N											
						S											
						H											
ISO	La max	S±0.025	R±0.05	f	YBC252	YBC251		YBG105	YBG102	YB9320	YBG205	YBG202	YBG302	YD101	YD201		
ZTCD01002-EG	2.6	1	0.2	0,02-0,04									○				
ZTCD011502-EG	2.6	1.15	0.2	0,02-0,04									○				
ZTCD01202-EG	2.6	1.2	0.2	0,02-0,04									○				
ZTCD013802-EG	2.6	1.38	0.2	0,02-0,04									○				
ZTCD01402-EG	2.6	1.4	0.2	0,02-0,04									○				
ZTCD01500-EG	2.6	1.5	0	0,02-0,04									○				
ZTCD01502-EG	2.6	1.5	0.2	0,02-0,04									○				
ZTCD01503-EG	2.6	1.5	0.3	0,02-0,04									○				
ZTCD015503-EG	2.6	1.55	0.3	0,02-0,04									○				
ZTCD01602-EG	2.6	1.6	0.2	0,02-0,04									○				
ZTCD01702-EG	3.4	1.7	0.2	0,02-0,08									○				
ZTCD017503-EG	3.4	1.75	0.3	0,02-0,08									○				
ZTCD017602-EG	3.4	1.76	0.2	0,02-0,08									○				
ZTCD01802-EG	3.4	1.8	0.2	0,02-0,08									○				
ZTCD018502-EG	3.4	1.85	0.2	0,02-0,08									○				
ZTCD02000-EG	3.4	2	0	0,02-0,08									○				
ZTCD02002-EG	3.4	2	0.2	0,02-0,08									●				
ZTCD020503-EG	3.4	2.05	0.3	0,02-0,08									○				
ZTCD021502-EG	3.4	2.15	0.2	0,02-0,08									○				
ZTCD02302-EG	3.4	2.3	0.2	0,03-0,11									○				
ZTCD02303-EG	3.4	2.3	0.3	0,03-0,11									○				
ZTCD02402-EG	3.4	2.4	0.2	0,03-0,11									○				

● Ex stock ○ On demand

HC¹ Coated carbide
HW Uncoated carbide

Tool holders

QECD

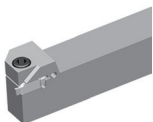

A428

System code > A398

Grade selection > A394

Technical info > A501

Cutting data > A456



A

Turning

B

Milling

C

Drilling

D

Technical Information



E











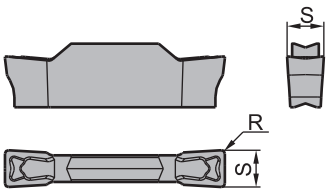





Index

A

Turning

Parting inserts

-  Ideal machining conditions
-  Normal machining conditions
-  Unfavourable machining conditions

Parting & grooving insert (double sided)					HC ¹ (CVD)		HC ¹ (PVD)					HW	
	P												
	M												
	K												
	N												
	S												
	H												

B

Milling

ISO	La max	S±0.025	R±0.05	f	YBC252 YBC251		YBG105 YBG102 YB9320 YBG205 YBG202 YBG302					YD101 YD201			
ZTED02502-EG	17	2.5	0.2	0,03-0,11											
ZTED026502-EG	17	2.65	0.2	0,03-0,11											
ZTED02702-EG	17	2.7	0.2	0,03-0,11											
ZTED02703-EG	17	2.7	0.3	0,03-0,11											
ZTED02802-EG	17	2.8	0.2	0,04-0,13											
ZTED02803-EG	17	2.8	0.3	0,04-0,13											
ZTED02804-EG	17	2.8	0.4	0,04-0,13											
ZTED02903-EG	17	2.9	0.3	0,04-0,13											
ZTFD03001-EG	17	3	0.1	0,04-0,13											
ZTFD03002-EG	17	3	0.2	0,04-0,13											
ZTFD03003-EG	17	3	0.3	0,04-0,13											
ZTFD03203-EG	17	3.2	0.3	0,04-0,13											
ZTFD0325024-EG	17	3.25	2.4	0,04-0,13											
ZTFD03302-EG	17	3.3	0.2	0,04-0,13											
ZTFD03303-EG	17	3.3	0.3	0,04-0,13											
ZTFD03403-EG	17	3.4	0.3	0,04-0,13											
ZTFD035-EG	17	3.5	0	0,04-0,13											
ZTGD039602-EG	22	3.96	0.2	0,07-0,18											
ZTGD04002-EG	22	4	0.2	0,07-0,18											
ZTGD04003-EG	22	4	0.3	0,07-0,18											
ZTGD04004-EG	22	4	0.4	0,07-0,18											
ZTGD04008-EG	22	4	0.8	0,07-0,18											
ZTGD04503-EG	22	4.5	0.3	0,07-0,18											
ZTGD04505-EG	22	4.5	0.5	0,07-0,18											
ZTGD04805-EG	22	4.8	0.5	0,1-0,24											
ZTHD05003-EG	22	5	0.3	0,1-0,24											
ZTHD05004-EG	22	5	0.4	0,1-0,24											
ZTHD05008-EG	22	5	0.8	0,1-0,24											
ZTHD05012-EG	22	5	0.12	0,1-0,24											
ZTHD05202-EG	22	5.2	0.2	0,1-0,24											
ZTHD052503-EG	22	5.25	0.3	0,1-0,24											
ZTHD05508-EG	22	5.5	0.8	0,1-0,24											

C

Drilling

D

Technical Information

E

Index

● Ex stock ○ On demand



HC¹ Coated carbide
HW Uncoated carbide

System code > A398











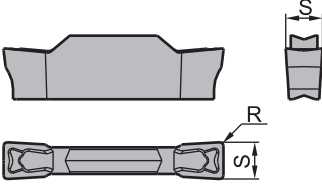







Grade selection > A394

Technical info > A501

Cutting data > A456

-  Ideal machining conditions
-  Normal machining conditions
-  Unfavourable machining conditions



Parting inserts

Parting & grooving insert (double sided)						HC ¹ (CVD)		HC ¹ (PVD)			HW	
	P	 						   				
	M							   				
	K											
	N										 	
	S								    			
	H											
ISO	La max	S±0.025	R±0.05	f	YBC252 YBC251			YBG105 YBG102 YB9320 YBG205 YBG202 YBG302			YD101 YD201	
	ZTKD06004-EG	22	6	0,4	0,12-0,29							
	ZTKD06504-EG	22	6,5	0,4	0,12-0,29							

● Ex stock ○ On demand

HC¹ Coated carbide
HW Uncoated carbide

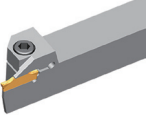
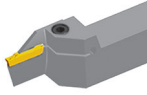
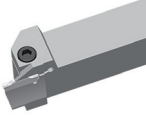
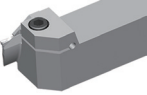
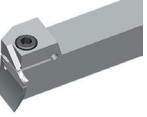
Tool holders

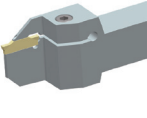
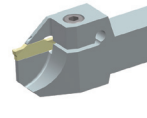
QE*D*R/L	QF*D*R/L-H	QF*D*RR-H	QF*D*LL-H	QF*D*R/L-L	C***-Q*DR/L	QE*D*R/L-DGC
						
A425	A434	A436	A436	A439	A444	A446
QE*D*R/L-DGSC	QE*D*R/L-SC					
						
A448	A449					

System code > A398

Grade selection > A394

Technical info > A501



Cutting data > A456











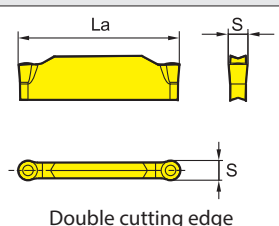







A

Turning

Parting inserts

-  Ideal machining conditions
-  Normal machining conditions
-  Unfavourable machining conditions

Parting & grooving insert (double sided)		HC ¹ (CVD)		HC ¹ (PVD)			HW		
 <p>Double cutting edge</p>	P								
	M								
	K								
	N								
	S								
H									

B

Milling

ISO	La max	S±0.10	f	YBC252		YBC251		YBG105		YBG102		YBG320		YBG205		YBG202		YBG302		YD101		YD201	
				●	○	●	○	●	○	●	○	●	○	●	○	●	○	●	○	●	○	●	○
	ZRED025-MG	17.5	2.5	0,03-0,11																			
	ZRFD03-MG	17	3	0,04-0,14																			
	ZRGD04-MG	21	4	0,07-0,2		○																	
	ZRHD05-MG	20	5	0,1-0,24																			○
	ZRKD06-MG	19	6	0,12-0,29																			

● Ex stock ○ On demand

HC¹ Coated carbide
HW Uncoated carbide

C

Drilling

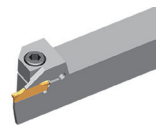
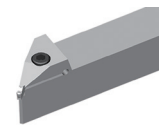
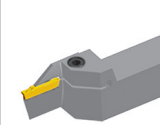
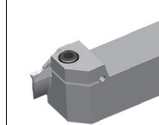
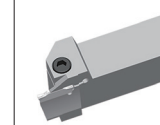
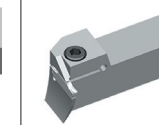
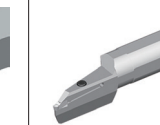
Tool holders						
QE*D*R/L	QX*D*	QF*D*R/L-H	QF*D*LL-H	QF*D*RR-H	QF*D*R/L-L	C*X-Q*DR/L
						
A425	A429	A434	A436	A436	A439	A443

C***-Q*DR/L



A444

D

Technical Information

E



Index

System code > A398











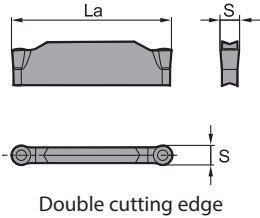







Grade selection > A394

Technical info > A501

Cutting data > A456

-  Ideal machining conditions
-  Normal machining conditions
-  Unfavourable machining conditions



Parting inserts

Parting & grooving insert (double sided)					HC ¹ (CVD)		HC ¹ (PVD)			HW		
 <p>Double cutting edge</p>	P	 					   					
	M						   					
	K											
	N									 		
	S							    				
	H											
ISO	La max	S±0.025	f	YBC252 YBC251			YBG105 YBG102 YB9320 YBG205 YBG202 YBG302		YD101 YD201			
	ZRFD03-EG	17	3	0,04-0,14				●	○			
	ZRGD04-EG	21	4	0,07-0,2				●				
	ZRHD05-EG	20	5	0,1-0,24				●	○			
	ZRKD06-EG	19	6	0,12-0,29				○				

● Ex stock ○ On demand

HC¹ Coated carbide
HW Uncoated carbide

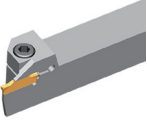
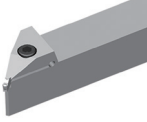
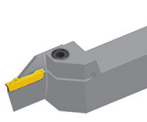
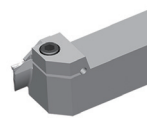
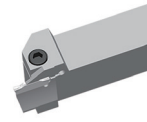
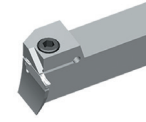
Tool holders

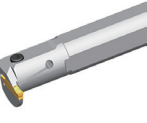
QE*D*R/L	QX*D*	QF*D*R/L-H	QF*D*LL-H	QF*D*RR-H	QF*D*R/L-L	C*X-Q*DR/L
						
A425	A429	A434	A436	A436	A439	A443
C***-Q*DR/L						
						
A444						

System code > A398

Grade selection > A394

Technical info > A501

Cutting data > A456

A

Turning

Parting inserts

- Ideal machining conditions
- ⊗ Normal machining conditions
- ⊗ Unfavourable machining conditions

Parting & grooving insert (single sided)							HC ¹ (CVD)		HC ¹ (PVD)			HW		
	P	⊗	⊗						⊗	⊗	⊗	⊗		
	M								⊗	⊗	⊗	⊗		
	K													
	N												●	⊗
	S								●	●	⊗	⊗		
	H													

B

Milling

ISO	R±0.1	W±0.05	b	L	f	YBC252		YBC251		YBG105		YBG102		YB9320		YBG205		YBG202		YBG302		YD101		YD201	
ZIMF304N-NM	0.4	3	2.4	15.3	0,04-0,11					●															
ZIMF406N-NM	0.6	4	3.2	15.3	0,07-0,16					●	○														
ZIMF506N-NM	0.6	5	4	15.3	0,1-0,2					●	○														
ZIMF608N-NM	0.8	6	4	15.3	0,12-0,23					●	○														

● Ex stock ○ On demand

HC¹ Coated carbide
HW Uncoated carbide

C

Drilling

Tool holders

QE*S*R/L-N

A430

D

Technical Information

E



Index

System code > A398











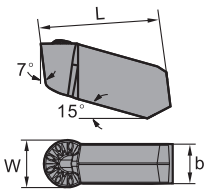







Grade selection > A394

Technical info > A501

Cutting data > A456

-  Ideal machining conditions
-  Normal machining conditions
-  Unfavourable machining conditions

Parting inserts

Parting & grooving insert (single sided)					HC ¹ (CVD)		HC ¹ (PVD)				HW							
	P																	
	M																	
	K																	
	N																	
	S																	
H																		
ISO	W±0.05	b	L	f	YBC252	YBC251				YBG105	YBG102	YB9320	YBG205	YBG202	YBG302		YD101	YD201
	ZIGQ3N-NM	3	2.4	15.3	0,04-0,11					●	○							
	ZIGQ4N-NM	4	3.2	15.3	0,07-0,16					●	○							
	ZIGQ5N-NM	5	4	15.3	0,1-0,2					●	○							
	ZIGQ6N-NM	6	5	15.3	0,13-0,24					●								

● Ex stock ○ On demand

HC¹ Coated carbide
HW Uncoated carbide

Tool holders

QE*S*R/L-N

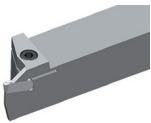

A430

System code > A398

Grade selection > A394

Technical info > A501

Cutting data > A456



A

Turning

B

Milling

C

Drilling

D

Technical Information



E











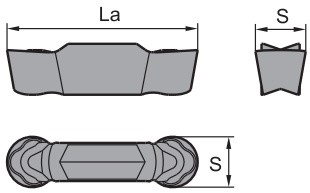







Index

A

Turning

Parting inserts

-  Ideal machining conditions
-  Normal machining conditions
-  Unfavourable machining conditions

Parting & grooving insert (double sided)					HC ¹ (CVD)		HC ¹ (PVD)			HW				
	P													
	M													
	K													
	N													
	S													
	H													
	ISO	La max	S±0.025	f	YBC252	YBC251	YBG105	YBG102	YB9320	YBG205	YBG202	YBG302	YD101	YD201
	ZRKD06-LH	19	6	0,12-0,23										
	ZRLD08-LH	22	8	0,14-0,26										

● Ex stock ○ On demand

HC¹ Coated carbide
HW Uncoated carbide

B

Milling

C

Drilling

D

Technical Information

E

Index

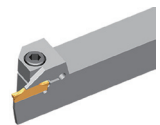
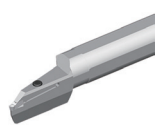
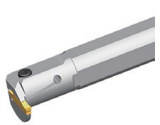

Tool holders		
QE*D*R/L	C*X-Q*DR/L	C***-Q*DR/L
		
A425	A443	A444

System code > A398











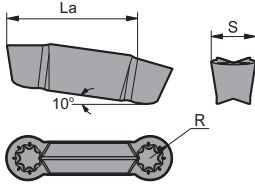







Grade selection > A394

Technical info > A501

Cutting data > A456

-  Ideal machining conditions
-  Normal machining conditions
-  Unfavourable machining conditions

Parting inserts

Parting & grooving insert (double sided)					HC ¹ (CVD)		HC ¹ (PVD)			HW		
	P											
	M											
	K											
	N											
	S											
	H											
ISO	La max	S±0.025	f	YBC252 YBC251			YBG105 YBG102 YB9320 YBG205 YBG202 YBG302				YD101 YD201	
	ZILD08-LC	22	8	0,14-0,26							○ ○	

● Ex stock ○ On demand

HC¹ Coated carbide
HW Uncoated carbide

A

Turning

B

Milling

C

Drilling

D

Technical Information

E

Index

System code > A398

Grade selection > A394

Technical info > A501



Cutting data > A456





Triangular, tangential grooving inserts (straight edge)

QC 22 R 300 – R 03

1 2 3 4 5 6



Series	Cutting edge length [mm]		Cutting direction	
	Code	I.C	Code	Description
	11	6,35	R	 Right
	16	9,525	L	 Left
	22	12,70		
1	2		3	

Groove width [mm]		Edge shape		Radius/Chamfer [mm]	
Code	Description	Code	Description	Code	Description
050	0,50	R	 Radius	005	0,05
100	1,00	C	 Chamfer	02	0,2
...	...			03	0,3
480	4,80			04	0,4
4	5	6			

Triangular, tangential grooving inserts (round edge)

QC 22 R 300 – R

1 2 3 4 5

Series	Cutting edge length [mm]		Cutting direction		Groove width [mm]		Round
	Code	I.C	Code	Description	Code	Description	
	11	6,35	R	 Right	050	0,50	
	16	9,525	L	 Left	100	1,00	
	22	12,70			
1	2	3	4	5			

A

Turning

B

Milling

C

Drilling



D

Technical Information

E

Index

Parting inserts

-  Ideal machining conditions
-  Normal machining conditions
-  Unfavourable machining conditions

QC** turning/milling insert

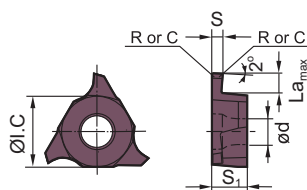

Right hand style

QC** turning/milling insert								HC ¹ (CVD)		HC ¹ (PVD)			HW				
								P	M	K	N	S	H				
ISO	La max	S±0.025	R/C	ØI.C	S1	ød	f	YBC252	YBC251	YBG105	YBG102	YB9320	YBG205	YBG202	YBG302	YD101	YD201
QC11R120-R02	1.5	1.2	0.2	6.35	3.18	2.8	0,02-0,03						●				
QC11L120-R02	1.5	1.2	0.2	6.35	3.18	2.8	0,02-0,03						●				
QC11R125-R02	1.5	1.25	0.2	6.35	3.18	2.8	0,02-0,03						●				
QC11L125-R02	1.5	1.25	0.2	6.35	3.18	2.8	0,02-0,03						●				
QC11R145-R02	1.5	1.45	0.2	6.35	3.18	2.8	0,02-0,05						●				
QC11L145-R02	1.5	1.45	0.2	6.35	3.18	2.8	0,02-0,05						●				
QC11R150-R02	1.5	1.5	0.2	6.35	3.18	2.8	0,02-0,05						●				
QC11L150-R02	1.5	1.5	0.2	6.35	3.18	2.8	0,02-0,05						●				
QC11R200-R02	2	2	0.2	6.35	3.18	2.8	0,02-0,06						●				
QC11L200-R02	2	2	0.2	6.35	3.18	2.8	0,02-0,06						●				
QC11R225-R02	2	2.25	0.2	6.35	3.18	2.8	0,02-0,06						○				
QC11L225-R02	2	2.25	0.2	6.35	3.18	2.8	0,02-0,06						○				
QC16R075-R01	2	0.75	0.1	9.525	3.18	4.4	0,02-0,03						○				
QC16L075-R01	2	0.75	0.1	9.525	3.18	4.4	0,02-0,03						○				
QC16R080-R01	2	0.8	0.1	9.525	3.18	4.4	0,02-0,03						○				
QC16R095-R01	2	0.95	0.1	9.525	3.18	4.4	0,02-0,03						○				
QC16L095-R01	2	0.95	0.1	9.525	3.18	4.4	0,02-0,03						○				
QC16L100-R01	2	1	0.1	9.525	3.18	4.4	0,02-0,03						○				
QC16R110-R01	2	1.1	0.1	9.525	3.18	4.4	0,02-0,03						○				
QC16L110-R01	2	1.1	0.1	9.525	3.18	4.4	0,02-0,03						● ○				
QC16R115-R04	2	1.15	0.4	9.525	3.18	4.4	0,02-0,03						○				
QC16R120-R01	2	1.2	0.1	9.525	3.18	4.4	0,02-0,03						○				
QC16L120-R01	2	1.2	0.1	9.525	3.18	4.4	0,02-0,03						○				
QC16R125-R02	2	1.25	0.2	9.525	3.18	4.4	0,02-0,03						○				
QC16L125-R02	2	1.25	0.2	9.525	3.18	4.4	0,02-0,03						●				
QC16R130-R02	2	1.3	0.2	9.525	3.18	4.4	0,02-0,06						○				
QC16L130-R02	2	1.3	0.2	9.525	3.18	4.4	0,02-0,06						○				
QC16R140-R02	2	1.4	0.2	9.525	3.18	4.4	0,02-0,06						○				
QC16R145-R02	2	1.45	0.2	9.525	3.18	4.4	0,02-0,06						●				
QC16L145-R02	2	1.45	0.2	9.525	3.18	4.4	0,02-0,06						●				
QC16R150-R02	2	1.5	0.2	9.525	3.18	4.4	0,02-0,06						●				
QC16L150-R02	2	1.5	0.2	9.525	3.18	4.4	0,02-0,06						○				
QC16R160-R02	2	1.6	0.2	9.525	3.18	4.4	0,02-0,06						●				
QC16L160-R02	2	1.6	0.2	9.525	3.18	4.4	0,02-0,06						●				

● Ex stock ○ On demand

HC¹ Coated carbide
HW Uncoated carbide





A
Turning
B
Milling
C
Drilling
D
Technical Information
E
Index









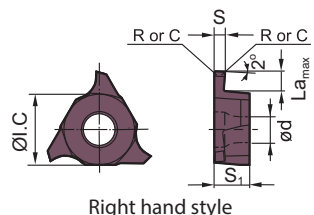





A

Turning

Parting inserts

-  Ideal machining conditions
-  Normal machining conditions
-  Unfavourable machining conditions



QC** turning/milling insert								HC ¹ (CVD)		HC ¹ (PVD)			HW		
															
															
															
															

B

Milling

ISO	La max	S±0.025	R/C	Øl.C	S1	ød	f	YBC252	YBC251	YBG105	YBG102	YB9320	YBG205	YBG202	YBG302	YD101	YD201
QC16R165-R02	2	1.65	0.2	9.525	3.18	4.4	0,02-0,06						○				
QC16L165-R02	2	1.65	0.2	9.525	3.18	4.4	0,02-0,06						○				
QC16R170-R02	2	1.7	0.2	9.525	3.18	4.4	0,02-0,06						○				
QC16L170-R02	2	1.7	0.2	9.525	3.18	4.4	0,02-0,06						○				
QC16R175-R02	2	1.75	0.2	9.525	3.18	4.4	0,02-0,07						●				
QC16L175-R02	2	1.75	0.2	9.525	3.18	4.4	0,02-0,06						○				
QC16R180-R02	2	1.8	0.2	9.525	3.18	4.4	0,02-0,07						○				
QC16R185-R02	2.5	1.85	0.2	9.525	3.18	4.4	0,02-0,07						●				
QC16L185-R02	2.5	1.85	0.2	9.525	3.18	4.4	0,02-0,07						○				
QC16R200-R02	2.5	2	0.2	9.525	3.18	4.4	0,02-0,07						●				
QC16L200-R02	2.5	2	0.2	9.525	3.18	4.4	0,02-0,07						●				
QC16L210-R02	2.5	2.1	0.2	9.525	3.18	4.4	0,02-0,07						○				
QC16L210-R05	2.5	2.1	0.5	9.525	3.18	4.4	0,02-0,07						○				
QC16R220-R02	2.5	2.2	0.2	9.525	3.18	4.4	0,02-0,07						○				
QC16L220-R02	2.5	2.2	0.2	9.525	3.18	4.4	0,02-0,07						○				
QC16R250-R02	2.5	2.5	0.2	9.525	3.18	4.4	0,02-0,08						● ○				
QC16L250-R02	2.5	2.5	0.2	9.525	3.18	4.4	0,02-0,08						●				
QC16R300-R02	3	3	0.2	9.525	3.18	4.4	0,03-0,11						●				
QC16L300-R02	3	3	0.2	9.525	3.18	4.4	0,03-0,11						●				
QC22L100-R02	2	1	0.2	12.7	4.76	5.5	0,02-0,03						○				
QC22R125-R02	2	1.25	0.2	12.7	4.76	5.5	0,02-0,03						●				
QC22L125-R02	2	1.25	0.2	12.7	4.76	5.5	0,02-0,03						○				
QC22R145-R02	2	1.45	0.2	12.7	4.76	5.5	0,02-0,06						○				
QC22L145-R02	2	1.45	0.2	12.7	4.76	5.5	0,02-0,06						○				
QC22R150-R02	3.5	1.5	0.2	12.7	4.76	5.5	0,02-0,06						○				
QC22L150-R02	3.5	1.5	0.2	12.7	4.76	5.5	0,02-0,06						○				
QC22R175-R02	3.5	1.75	0.2	12.7	4.76	5.5	0,02-0,06						●				
QC22L175-R02	3.5	1.75	0.2	12.7	4.76	5.5	0,02-0,06						○				
QC22R185-R02	3.5	1.85	0.2	12.7	4.76	5.5	0,02-0,07						●				
QC22L185-R02	3.5	1.85	0.2	12.7	4.76	5.5	0,02-0,07						○				
QC22R195-R02	3.5	1.95	0.2	12.7	4.76	5.5	0,02-0,07						○				
QC22R200-R02	3.5	2	0.2	12.7	4.76	5.5	0,02-0,07						○				
QC22L200-R02	3.5	2	0.2	12.7	4.76	5.5	0,02-0,07						○				
QC22R225-R02	3.5	2.25	0.2	12.7	4.76	5.5	0,02-0,07						○				

● Ex stock ○ On demand

HC¹ Coated carbide
HW Uncoated carbide

C

Drilling

D

Technical Information

E

Index

System code > A416

Grade selection > A394

Technical info > A501

Cutting data > A456

Parting inserts

- Ideal machining conditions
- Normal machining conditions
- Unfavourable machining conditions

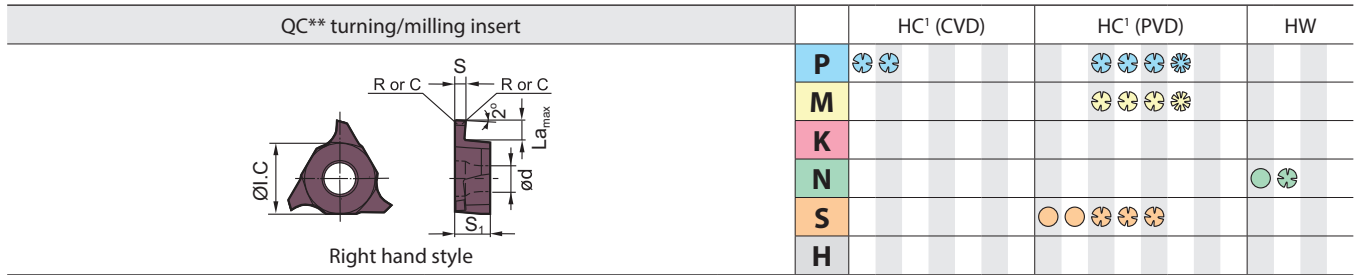

QC** turning/milling insert									HC ¹ (CVD)		HC ¹ (PVD)			HW						
									P											
									M											
									K											
									N											
									S											
									H											
ISO	La max	S±0.025	R/C	ØI.C	S1	ød	f		YBC252	YBC251		YBG105	YBG102	YB9320	YBG205	YBG202	YBG302	YD101	YD201	
QC22R230-R02	3.5	2.3	0.2	12.7	4.76	5.5	0,02-0,07								●					
QC22L230-R02	3.5	2.3	0.2	12.7	4.76	5.5	0,02-0,07								○					
QC22R250-R03	4	2.5	0.3	12.7	4.76	5.5	0,02-0,08								●					
QC22L250-R03	4	2.5	0.3	12.7	4.76	5.5	0,02-0,08								○					
QC22R265-R03	4	2.65	0.3	12.7	4.76	5.5	0,02-0,08								●					
QC22L265-R03	4	2.65	0.3	12.7	4.76	5.5	0,02-0,08								●					
QC22R280-R03	4	2.8	0.3	12.7	4.76	5.5	0,02-0,08								●					
QC22L280-R03	4	2.8	0.3	12.7	4.76	5.5	0,02-0,08								○					
QC22R300-R03	4	3	0.3	12.7	4.76	5.5	0,03-0,11								○					
QC22L300-R03	4	3	0.3	12.7	4.76	5.5	0,03-0,11								○					
QC22R320-R03	4	3.2	0.3	12.7	4.76	5.5	0,03-0,11								○					
QC22L320-R03	4	3.2	0.3	12.7	4.76	5.5	0,03-0,11								○					
QC22R330-R03	4	3.3	0.3	12.7	4.76	5.5	0,03-0,11								○					
QC22L330-R03	4	3.3	0.3	12.7	4.76	5.5	0,03-0,11								○					
QC22R350-R03	5	3.5	0.3	12.7	4.76	5.5	0,05-0,13								○					
QC22L350-R03	5	3.5	0.3	12.7	4.76	5.5	0,05-0,13								○					
QC22R400-R04	5	4	0.4	12.7	4.76	5.5	0,05-0,14								○					
QC22L400-R04	5	4	0.4	12.7	4.76	5.5	0,05-0,14								●					
QC22R430-R04	5	4.3	0.4	12.7	4.76	5.5	0,05-0,14								○					
QC22L430-R04	5	4.3	0.4	12.7	4.76	5.5	0,05-0,14								○	○				
QC22R450-R04	5	4.5	0.4	12.7	4.76	5.5	0,06-0,18								○					
QC22L450-R04	5	4.5	0.4	12.7	4.76	5.5	0,06-0,18								○				○	
QC22R480-R04	5	4.8	0.4	12.7	5.06	5.5	0,06-0,18								○					
QC22L480-R04	5	4.8	0.4	12.7	5.06	5.5	0,08-0,2								○					

● Ex stock ○ On demand



HC¹ Coated carbide
HW Uncoated carbide

Tool holders	
GQCR/L	S***-QC**R/L
A453	A454

A







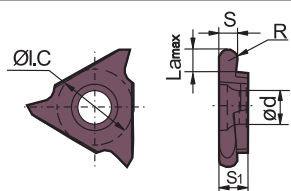













Turning

Parting inserts

-  Ideal machining conditions
-  Normal machining conditions
-  Unfavourable machining conditions



Right hand style

QC** turning/milling insert								HC ¹ (CVD)		HC ¹ (PVD)				HW	
P															
M															
K															
N															
S															
H															

B

Milling

ISO	La max	S±0.025	R/C	Øl.C	S1	ød	f	YBC252 YBC251		YBG105 YBG102 YBG320 YBG205 YBG202 YBG302					YD101 YD201	
QC16R100R	2	1	0.5	12.7	3.18	4.4	0,02-0,03									
QC16R120R	2	1.2	0.6	12.7	3.18	4.4	0,02-0,03									
QC16R150R	2	1.5	0.75	12.7	3.18	4.4	0,02-0,06									
QC16R200R	2.5	2	1	12.7	3.18	4.4	0,02-0,07									
QC16L200R	2.5	2	1	12.7	3.18	4.4	0,02-0,07									
QC16R250R	2.5	2.5	1.25	12.7	3.18	4.4	0,02-0,08									
QC16L280R	2.5	2.8	1.4	12.7	3.18	4.4	0,02-0,08									
QC16R300R	2.5	3	1.5	12.7	3.18	4.4	0,03-0,11									
QC16L300R	2.5	3	1.5	12.7	3.18	4.4	0,03-0,11									
QC22R100R	2	1	0.5	12.7	4.76	5.5	0,02-0,03									
QC22L100R	2	1	0.5	12.7	4.76	5.5	0,02-0,03									
QC22R150R	3.5	1.5	0.75	12.7	4.76	5.5	0,02-0,06									
QC22L150R	3.5	1.5	0.75	12.7	4.76	5.5	0,02-0,06									
QC22R170R	3.5	1.7	0.85	12.7	4.76	5.5	0,02-0,06									
QC22R200R	3.5	2	1	12.7	4.76	5.5	0,02-0,07									
QC22L200R	3.5	2	1	12.7	4.76	5.5	0,02-0,07									
QC22R250R	4	2.5	1.25	12.7	4.76	5.5	0,02-0,08									
QC22L250R	4	2.5	1.25	12.7	4.76	5.5	0,02-0,08									
QC22R300R	4	3	1.5	12.7	4.76	5.5	0,03-0,11									
QC22L300R	4	3	1.5	12.7	4.76	5.5	0,03-0,11									
QC22R320R	4	3.2	1.6	12.7	4.76	5.5	0,03-0,11									
QC22R400R	5	4	2	12.7	4.76	5.5	0,05-0,14									
QC22L400R	5	4	2	12.7	4.76	5.5	0,05-0,14									

● Ex stock ○ On demand

HC¹ Coated carbide
HW Uncoated carbide



C

Drilling

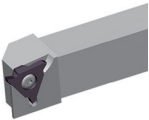

D

Technical Information

Tool holders	
GQCR/L	S***-QC**R/L
	
A453	A454

E

Index

System code > A416

Grade selection > A394

Technical info > A501

Cutting data > A456

Notes

A series of horizontal dotted lines for taking notes, organized into sections corresponding to the table of contents on the right.

A

Turning

B

Milling

C

Drilling

D

Technical
Information

E

Index

External tool holders

Q F G D 2525 R 22 (S) C – (130) (H)

1 2 3 4 5 6 7 8 9 10 11

Holder for parting & grooving
--

1

Application	
Code	Description
E	External machining
F	Axial machining

2

Insert seat size [mm]	
Holder/cutting width	
Code	Description
A	1,5
B	2,0
E	2,5
F	3,0
G	4,0
H	5,0
K	6,0
L	8,0

3

No. of cutting edges	
Code	Description
S	Single
D	Double

4

Cross section of holder [mm] x [mm]
--

5

Type	
Code	Description
R	Right
L	Left
N	Right and left

6

Max. cutting depth [mm]

7

Serie	
Code	Description
S	Swiss turning holder
DG	Cut-off holder for greater grooving depths with reinforcement
DGS	Cut-off holder for greater grooving depths without reinforcement

8

With internal cooling

9

Min. diameter of work piece for first axial grooving [mm]
--

10

Cutting head	
Code	Description
H	0°
L	90°

11

Boring bars

C 32 S – Q G D R 11 – 44

1 2 3 4 5 6 7 8 9

Clamping system	Diameter [mm]	Length [mm]		Holder for grooving
		Code	Description	
1	2	Q	180	4
		R	200	
		S	250	
		X	320	
3		4		

Insert seat size [mm]		No. of cutting edges	
Holder/Cutting width		Code	Description
Code	Description	S	Single
B	2.0	D	Double
E	2.5		
F	3.0		
G	4.0		
H	5.0		
K	6.0		
L	8.0		
5		6	

Type		Max. cutting depth [mm]	Min. internal diameter of work piece [mm]
Code	Description		
R	Right	8	9
L	Left		
N	Right and left		
7			

A
Turning
B
Milling
C
Drilling
D
Technical Information
E
Index

Blade

Q E G D 32 N (-1)

1 2 3 4 5 6 7



1

Application	
Code	Description
E	External machining

2

Insert seat size [mm]	
Holder/cutting width	
Code	Description
B	2,0
E	2,5
F	3,0
G	4,0
H	5,0
K	6,0
L	8,0

3

No. of cutting edges	
Code	Description
S	Single
D	Double

4

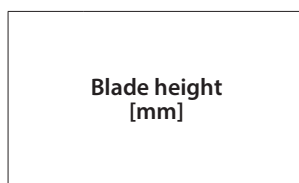

5

Type	
Code	Description
R	Right
L	Left
N	Right and left

6



7

Clamping block

QZ S 32 32

1 2 3 4

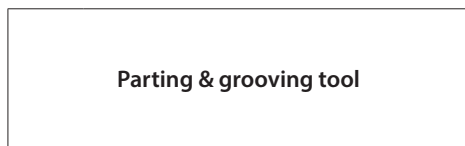

1

No. of cutting edges	
Code	Description
S	Single
D	Double

2

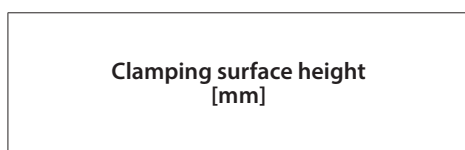

3

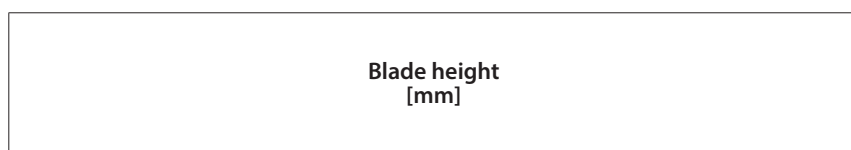

4

Parting & grooving tool holder (external)

QE**R/L

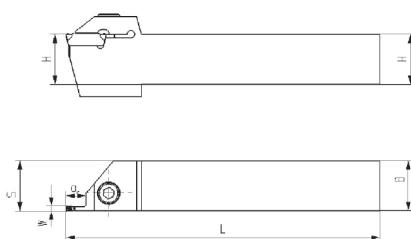
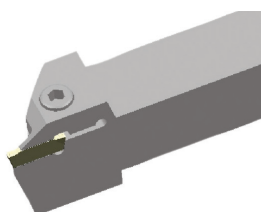

Article	*	Stock		Dimensions [mm]					Inserts
		R	L	HxB	L	S	W	ar _{max}	
QEED1616R/L10	●	●	16x16	125	15	2.5	10	Z*ED**	
QEED1616R/L17	●	●	16x16	125	15	2.5	17	Z*ED**	
QEED2020R/L17	●	●	20x20	125	19	2.5	17	Z*ED**	
QEED2020R/L10	●	●	20x20	150	10	2.5	10	Z*ED**	
QEED2525R/L10	●	●	25x25	150	19	2.5	10	Z*ED**	
QEED2525R/L17	●	●	25x25	150	19	2.5	17	Z*ED**	
QEGD2020R/L13	●	●	20x20	140	18.5	4	13	Z*GD**	
QEGD2020R/L22	●	●	20x20	140	18.5	4	22	Z*GD**	
QEGD2525R/L13	●	●	25x25	150	23.5	4	13	Z*GD**	
QEGD2525R/L22	●	●	25x25	150	23.5	4	22	Z*GD**	
QEGD3232R/L13	●	●	32x32	170	30.5	4	13	Z*GD**	
QEGD3232R/L22	●	●	32x32	170	30.5	4	22	Z*GD**	
QEHD2525R/L13	●	●	25x25	150	23	5	13	Z*HD**	
QEHD2525R/L22	●	●	25x25	150	23	5	22	Z*HD**	
QEHD3232R/L13	●	●	32x32	170	30	5	13	Z*HD**	
QEHD3232R/L22	●	●	32x32	170	30	5	22	Z*HD**	
QEKD2525R/L13	●	●	25x25	150	22.6	6	13	Z*KD**	
QEKD2525R/L22	●	●	25x25	150	22.6	6	22	Z*KD**	
QEKD3232R/L13	●	●	32x32	170	29.6	6	13	Z*KD**	
QEKD3232R/L22	●	●	32x32	170	29.6	6	22	Z*KD**	

● Ex stock ○ On demand

* With internal cooling

System code > A422

Grade selection > A394



Technical info > A501

Cutting data > A456











Parting & grooving tool holder (external)

Spare parts

	Insert	Z*BD**	Z*ED**	Z*ED**	Z*FD**	Z*FD**	Z*GD**	Z*HD**	Z*KD**
	H	16-20	16	20-32	16	20-32	20-32	20-32	20-32
 Screw		GB70-85-M5×16 (4.0 Nm)	GB70-85-M5×20 (4.0 Nm)	GB70-85-M6×20 (7.0 Nm)	GB70-85-M5×20 (4.0 Nm)	GB70-85-M6×20 (7.0 Nm)	GB70-85-M6×20 (7.0 Nm)	GB70-85-M6×20 (7.0 Nm)	GB70-85-M6×20 (7.0 Nm)
 Wrench		WH40L	WH40L	WH50L	WH40L	WH50L	WH50L	WH50L	WH50L

Insert

						
A399	A400	A401	A404	A407	A410	A411
						
A414						

System code > A422

Grade selection > A394

Technical info > A501

Cutting data > A456

Parting & grooving tool holder (external)

QE*SN30

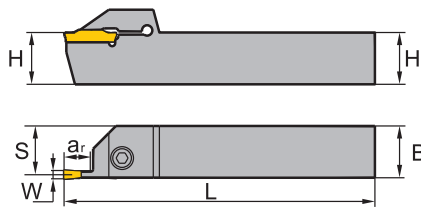
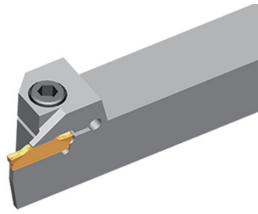

Article	*	Stock	Dimensions [mm]					Inserts
			HxB	L	S	W	ar _{max}	
QEHS2525N30		●	25x25	150	12.5	5	30	Z*HS**
QEHS3232N30		●	32x32	170	16	5	30	Z*HS**
QEKS2525N30		○	25x25	150	12.5	6	30	Z*Ks**
QEKS3232N30		○	32x32	170	16	6	30	Z*Ks**

● Ex stock ○ On demand

* With internal cooling

Spare parts			
	Insert	Z*HS**	Z*Ks**
	H	25-32	25-32
	Screw	GB70-85-M6x20 (7.0 Nm)	GB70-85-M6x20 (7.0 Nm)
	Wrench	WH50L	WH50L

Insert		
A402	A405	A406

System code > A422

Grade selection > A394

Technical info > A501

Cutting data > A456



A

Turning

B

Milling

C

Drilling

D

Technical Information

E

Index

Parting & grooving tool holder (external)

QECDR/L

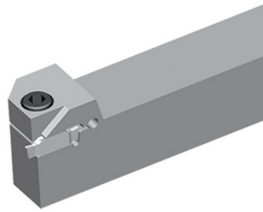

Right hand style

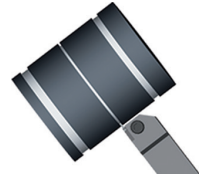
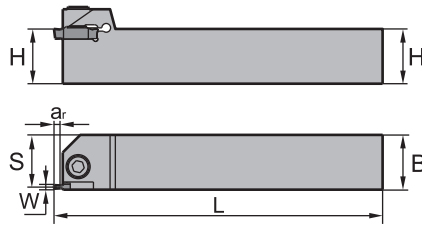

Article	*	Stock		Dimensions [mm]					Inserts
		R	L	HxB	L	S	W	ar _{max}	
QECD1616R/L025		○	○	16x16	125	14.75		2.5	Z*CD**
QECD2020R/L025		○	○	20x20	125	18.75		2.5	Z*CD**
QECD2525R/L025		○	○	25x25	150	23.75		2.5	Z*CD**

● Ex stock ○ On demand

* With internal cooling

Spare parts

	Insert	Z*CD**	Z*CD**
	H	16	20-32
	Screw	GB70-85-M5x20 (4.0 Nm)	GB70-85-M6x20 (7.0 Nm)
	Wrench	WH40L	WH50L

Insert



A407

System code > A422

Grade selection > A394

Technical info > A501

Cutting data > A456

Parting & grooving tool holder (external)

QX*DR/L

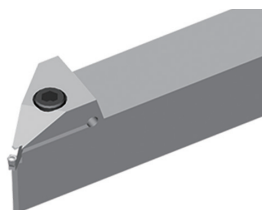

Right hand style

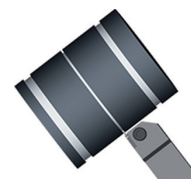
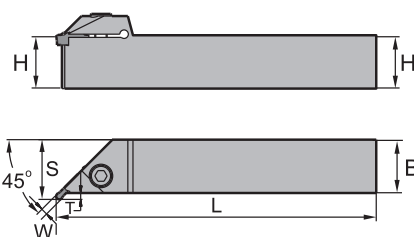

Article	*	Stock		Dimensions [mm]					Inserts
		R	L	HxB	L	S	W	ar _{max}	
QXFD2020R/L03-45		○	○	20x20	125	23	3	3	Z*FD**
QXFD2525R/L03-45		●	●	25x25	150	28	3	3	Z*FD**
QXFD3232R/L03-45		○	○	32x32	170	35	3	3	Z*FD**
QXGD2020R/L03-45		○	○	20x20	125	23	4	3	Z*GD**
QXGD2525R/L03-45		○	○	25x25	150	28	4	3	Z*GD**
QXGD3232R/L03-45		○	○	32x32	170	35	4	3	Z*GD**
QXHD2020R/L04-45		○	○	20x20	125	24	5	4	Z*HD**
QXHD2525R/L04-45		○	○	25x25	150	29	5	4	Z*HD**
QXHD3232R/L04-45		○	○	32x32	170	36	5	4	Z*HD**
QXKD2020R/L04-45		○	○	20x20	125	24	6	4	Z*KD**
QXKD2525R/L04-45		○	○	25x25	150	29	6	4	Z*KD**
QXKD3232R/L04-45		○	○	32x32	170	36	6	4	Z*KD**

● Ex stock ○ On demand

* With internal cooling

Spare parts

	Insert	Z*FD**	Z*GD**	Z*HD**	Z*KD**
	H	20-32	20-32	20-32	20-32
	Screw	GB70-85-M6x20 (7.0 Nm)	GB70-85-M6x20 (7.0 Nm)	GB70-85-M6x20 (7.0 Nm)	GB70-85-M6x20 (7.0 Nm)
	Wrench	WH50L	WH50L	WH50L	WH50L

Insert

A410	A411

Parting & grooving tool holder (external)

QE*SR/L

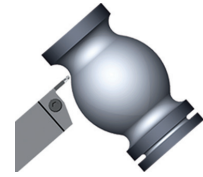
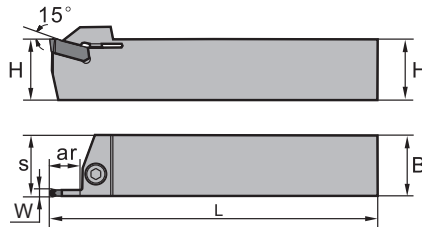
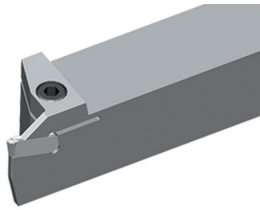

Right hand style

Article	*	Stock		Dimensions [mm]					Inserts
		R	L	HxB	L	S	W	ar _{max}	
QEFS2525R/L12-3N		○	○	25x25	150	25.3	3	12	ZI**
QEGS2525R/L12-4N		○	○	25x25	150	25.3	4	12	ZI**
QEHS2525R/L12-5N		○	○	25x25	150	25.4	5	12	ZI**
QEKS2525R/L12-6N		○	○	25x25	150	25.4	6	12	ZI**
QEFS3232R/L22-3N		○	○	32x32	170	32.3	3	22	ZI**
QEGS3232R/L22-4N		○	○	32x32	170	32.3	4	22	ZI**
QEHS3232R/L22-5N		○	○	32x32	170	32.4	5	22	ZI**
QEKS3232R/L22-6N		○		32x32	170	32.4	6	22	ZI**

● Ex stock ○ On demand

* With internal cooling

Spare parts

	Insert	ZI**
	H	25-32
	Screw	GB70-85-M6x20 (7.0 Nm)
	Wrench	WH50L

Insert

A412	A413

System code > A422

Grade selection > A394

Technical info > A501

Cutting data > A456

Parting blade for external machining

QE*S**N

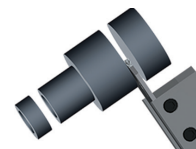
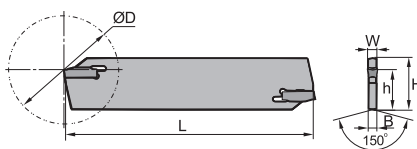
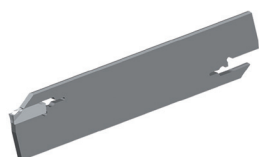

Article	*	Stock	Dimensions [mm]						Inserts
			H	L	h	B	W	ØDmax	
QEES26N	●		26	110	19	2	2.5	60	ZPES**
QEES32N	●		32	150	24.6	2	2.5	100	ZPES**
QEFS26N	●		26	110	19	2.4	3	60	ZPFS**
QEFS32N	●		32	150	24.6	2.4	3	100	ZPFS**
QEGS26N	●		26	110	19	3.2	4	70	ZPGS**
QEGS32N	●		32	150	24.6	3.2	4	120	ZPGS**
QEHS26N	●		26	110	19	4	5	70	ZPHS**
QEHS32N	●		32	150	24.6	4	5	120	ZPHS**
QEKs26N	●		26	110	19	5	6	70	ZPKS**
QEKs32N	●		32	150	24.6	5	6	120	ZPKS**

● Ex stock ○ On demand

* With internal cooling

Spare parts						
	Insert	ZPES**	ZPFS**	ZPGS**	ZPHS**	ZPKS**
	H	26-32	26-32	26-32	26-32	26-32
	Wrench	W50RL	W50RL	W50RL	W50RL	W50RL

Insert			
A402	A403	A405	A406

System code > A422

Grade selection > A394

Technical info > A501

Cutting data > A456

A

Parting blade for external machining

QE*S**N-1

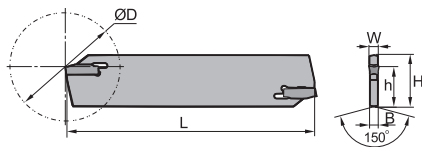
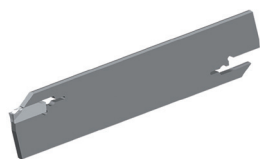

Turning

B

Article	*	Stock	Dimensions [mm]						Inserts
			H	L	h	B	W	ØDmax	
QEES26N-1	●		26	110	19	2	2.5	60	ZPES**
QEES32N-1	●		32	150	24.6	2	2.5	100	ZPES**
QEFS26N-1	●		26	110	19	2.4	3	60	ZPFS**
QEFS32N-1	●		32	150	24.6	2.4	3	100	ZPFS**
QEGS26N-1	●		26	110	19	3.2	4	70	ZPGS**
QEGS32N-1	●		32	150	24.6	3.2	4	120	ZPGS**

Milling

C

● Ex stock ○ On demand

* With internal cooling

Only compatible with clamping blocks of commercially available systems from other manufacturers.

Drilling

Spare parts				
	Insert	ZPES**	ZPFS**	ZPGS**
	H	26-32	26-32	26-32
	Wrench	W50X	W50X	W50X

W50X key must be ordered as an option.

D

Insert		
A402	A403	A406

Technical Information

E

Index

System code > A422

Grade selection > A394

Technical info > A501

Cutting data > A456

Clamping block (external)

QZS*

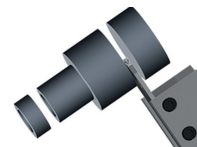
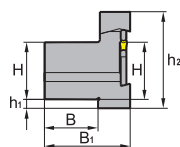
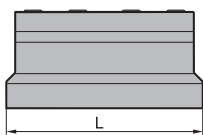
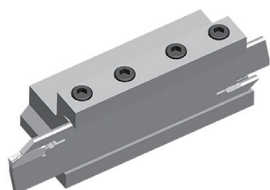

Article	*	Stock	Dimensions [mm]						Inserts
			H	L	h ₁	h ₂	B	B ₁	
QZS2026		●	20	86	10	46.6	19	38	QE**26
QZS2526		●	25	86	5	46.6	23	42	QE**26
QZS3226		○	32	86	3	51.6	30	48	QE**26
QZS2032		●	20	110	13	50	19	38	QE**32
QZS2532		●	25	110	8	50	23	42	QE**32
QZS3232		●	32	110	5	54	30	48	QE**32

● Ex stock ○ On demand

* With internal cooling

Spare parts			
	Insert	QE**26	QE**32
	H	20-32	20-32
	Clamp	QZC26	QZC32
	Screw	GB70-85-M6×20 (7.0 Nm)	GB70-85-M6×20 (7.0 Nm)
	Wrench	W50RL	W50RL

A

Turning

B

Milling

C

Drilling

D

Technical
Information

E

Index

Parting & grooving tool holder (axial)

QF**R/L

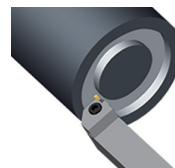
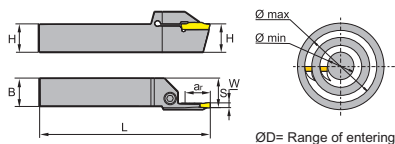
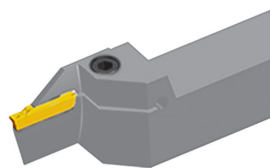

Left hand style

Article	*	Stock		Dimensions [mm]						Inserts
		R	L	HxB	L	S	W	ar _{max}	ØD (min-max)	
QFFD2020R/L7-48H	○	○	20x20	150	21	3	7	48-66	Z*FD**	
QFFD2020R/L7-60H	○	○	20x20	150	21	3	7	60-80	Z*FD**	
QFFD2020R/L7-74H	○	○	20x20	150	21	3	7	74-110	Z*FD**	
QFFD2020R/L7-100H	○	○	20x20	150	21	3	7	100-150	Z*FD**	
QFFD2020R/L10-48H	○	○	20x20	150	21	3	10	48-66	Z*FD**	
QFFD2020R/L10-60H	○	○	20x20	150	21	3	10	60-80	Z*FD**	
QFFD2020R/L10-74H	○	○	20x20	150	21	3	10	74-110	Z*FD**	
QFFD2020R/L10-100H	○	○	20x20	150	21	3	10	100-150	Z*FD**	
QFFD2525R/L10-48H	●	●	25x25	150	26	3	10	48-66	Z*FD**	
QFFD2525R/L10-60H	●	●	25x25	150	26	3	10	60-80	Z*FD**	
QFFD2525R/L10-74H	●	●	25x25	150	26	3	10	74-110	Z*FD**	
QFFD2525R/L10-100H	●	●	25x25	150	26	3	10	100-150	Z*FD**	
QFFD2525R/L17-48H	●	●	25x25	150	26	3	17	48-66	Z*FD**	
QFFD2525R/L17-60H	●	●	25x25	150	26	3	17	60-80	Z*FD**	
QFFD2525R/L17-74H	●	●	25x25	150	26	3	17	74-110	Z*FD**	
QFFD2525R/L17-100H	●	●	25x25	150	26	3	17	100-150	Z*FD**	
QFGD2020R/L10-52H	○	○	20x20	150	21	4	10	52-72	Z*GD**	
QFGD2020R/L10-64H	○	○	20x20	150	21	4	10	64-100	Z*GD**	
QFGD2020R/L10-90H	○	○	20x20	150	21	4	10	90-140	Z*GD**	
QFGD2020R/L10-130H	○	○	20x20	150	21	4	10	130-230	Z*GD**	
QFGD2020R/L15-52H	○	○	20x20	150	21	4	15	52-72	Z*GD**	
QFGD2020R/L15-64H	○	○	20x20	150	21	4	15	64-100	Z*GD**	
QFGD2020R/L15-90H	○	○	20x20	150	21	4	15	90-140	Z*GD**	
QFGD2020R/L15-130H	○	○	20x20	150	21	4	15	130-230	Z*GD**	
QFGD2525R/L13-52H	●	●	25x25	150	26	4	13	52-72	Z*GD**	
QFGD2525R/L13-64H	●	●	25x25	150	26	4	13	64-100	Z*GD**	
QFGD2525R/L13-90H	●	●	25x25	150	26	4	13	90-140	Z*GD**	
QFGD2525R/L13-130H	●	●	25x25	150	26	4	13	130-230	Z*GD**	
QFGD2525R/L22-52H	●	●	25x25	150	26	4	22	52-72	Z*GD**	
QFGD2525R/L22-64H	●	●	25x25	150	26	4	22	64-100	Z*GD**	
QFGD2525R/L22-90H	●	●	25x25	150	26	4	22	90-140	Z*GD**	
QFGD2525R/L22-130H	●	●	25x25	150	26	4	22	130-230	Z*GD**	
QFHD2525R/L13-58H	●	●	25x25	150	26	5	13	58-96	Z*HD**	
QFHD2525R/L13-86H	●	●	25x25	150	26	5	13	86-140	Z*HD**	
QFHD2525R/L13-130H	●	●	25x25	150	26	5	13	130-200	Z*HD**	
QFHD2525R/L13-185H	●	●	25x25	150	26	5	13	185-400	Z*HD**	

System code > A422

Grade selection > A394



Technical info > A501







Cutting data > A456

Article	*	Stock		Dimensions [mm]						Inserts
		R	L	HxB	L	S	W	ar _{max}	ØD (min-max)	
QFHD2523R/L16-44H		○		25x23	150		5	16	44-52	Z*HD**
QFHD2525R/L22-58H		●	●	25x25	150	26	5	22	58-96	Z*HD**
QFHD2525R/L22-86H		●	●	25x25	150	26	5	22	86-140	Z*HD**
QFHD2525R/L22-130H		●	●	25x25	150	26	5	22	130-200	Z*HD**
QFHD2525R/L22-185H		●	●	25x25	150	26	5	22	185-400	Z*HD**
QFKD2525R/L13-60H		●	●	25x25	150	26	6	13	60-100	Z*KD**
QFKD2525R/L13-88H		○	●	25x25	150	26	6	13	88-180	Z*KD**
QFKD2525R/L13-160H		●	●	25x25	150	26	6	13	160-400	Z*KD**
QFKD2525R/L20-45H			○	25x25	150		6	20	45-90	Z*KD**
QFKD2525R/L22-60H		●	●	25x25	150	26	6	22	60-100	Z*KD**
QFKD2525R/L22-88H		●	●	25x25	150	26	6	22	88-180	Z*KD**
QFKD2525R/L22-160H		●	●	25x25	150	26	6	22	160-400	Z*KD**
QFKD2525R/L30-88H		●		25x25	150		6	30	88-180	Z*KD**

● Ex stock ○ On demand

* With internal cooling

Spare parts					
	Insert	Z*FD**	Z*GD**	Z*HD**	Z*KD**
	H	20-25	20-25	20-25	20-25
	Screw	GB70-85-M6x20 (7.0 Nm)	GB70-85-M6x20 (7.0 Nm)	GB70-85-M6x20 (7.0 Nm)	GB70-85-M6x20 (7.0 Nm)
	Wrench	W50RL	W50RL	W50RL	W50RL

Insert					
					
A399	A400	A404	A407	A410	A411

System code > A422

Grade selection > A394

Technical info > A501

Cutting data > A456

Parting & grooving tool holder (axial)

QF**RR/LL

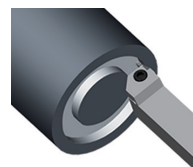
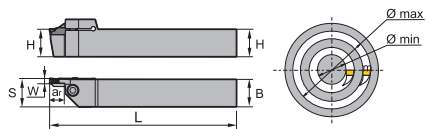
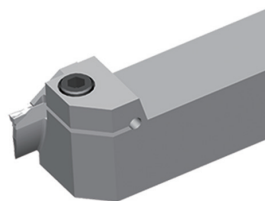

LL Version

Article	*	Stock		Dimensions [mm]						Inserts
		R	L	HxB	L	S	W	ar _{max}	ØD (min-max)	
QFFD2020LL10-48H		○		20x20	150	21	3	10	48-66	Z*FD**
QFFD2020RR10-48H		○		20x20	150	21	3	10	48-66	Z*FD**
QFFD2020RR10-60H		○		20x20	150	21	3	10	60-80	Z*FD**
QFFD2020RR10-74H		○		20x20	150	21	3	10	74-110	Z*FD**
QFFD2525LL10-48H			●	25x25	150	26	3	10	48-66	Z*FD**
QFFD2525RR10-48H		○		25x25	150	26	3	10	48-66	Z*FD**
QFFD2525LL10-60H			○	25x25	150	26	3	10	60-80	Z*FD**
QFFD2525RR10-60H		○		25x25	150	26	3	10	60-80	Z*FD**
QFFD2525LL10-74H			○	25x25	150	26	3	10	74-110	Z*FD**
QFFD2525RR10-74H		○		25x25	150	26	3	10	74-110	Z*FD**
QFFD2525LL10-100H			○	25x25	150	26	3	10	100-150	Z*FD**
QFFD2525RR10-100H		○		25x25	150	26	3	10	100-150	Z*FD**
QFFD2525LL17-48H			●	25x25	150	26	3	17	48-66	Z*FD**
QFFD2525RR17-48H		○		25x25	150	26	3	17	48-66	Z*FD**
QFFD2525LL17-60H			○	25x25	150	26	3	17	60-80	Z*FD**
QFFD2525RR17-60H		○		25x25	150	26	3	17	60-80	Z*FD**
QFFD2525LL17-74H			○	25x25	150	26	3	17	74-110	Z*FD**
QFFD2525RR17-74H		○		25x25	150	26	3	17	74-110	Z*FD**
QFFD2525LL17-100H			○	25x25	150	26	3	17	100-150	Z*FD**
QFFD2525RR17-100H		○		25x25	150	26	3	17	100-150	Z*FD**
QFGD2020LL10-52H			○	20x20	150	21	4	10	52-72	Z*GD**
QFGD2020RR10-52H		○		20x20	150	21	4	10	52-72	Z*GD**
QFGD2020LL15-52H			○	20x20	150	26	4	15	52-72	Z*GD**
QFGD2020RR15-52H		○		20x20	150	26	4	15	52-72	Z*GD**
QFGD2020LL15-90H			○	20x20	150	26	4	15	90-140	Z*GD**
QFGD2020RR15-90H		○		20x20	150	26	4	15	90-140	Z*GD**
QFGD2020RR15-130H		○		20x20	150	26	4	15	130-230	Z*GD**
QFGD2525RR13-52H			●	25x25	150	21	4	13	52-72	Z*GD**
QFGD2525LL13-64H			●	25x25	150	21	4	13	64-100	Z*GD**
QFGD2525RR13-64H		○		25x25	150	21	4	13	64-100	Z*GD**
QFGD2525LL13-130H			●	25x25	150	26	4	13	130-230	Z*GD**
QFGD2525RR13-130H		○		25x25	150	21	4	13	130-230	Z*GD**
QFGD2525LL22-52H			○	25x25	150	26	4	22	52-72	Z*GD**
QFGD2525RR22-52H		○		25x25	150	26	4	22	52-72	Z*GD**
QFGD2525LL22-64H			○	25x25	150	26	4	22	64-100	Z*GD**

System code > A422

Grade selection > A394

Technical info > A501



Cutting data > A456

Article	*	Stock		Dimensions [mm]						Inserts 
		R	L	HxB	L	S	W	ar _{max}	ØD (min-max)	
QFGD2525RR22-64H	○			25x25	150	26	4	22	64-100	Z*GD**
QFGD2525LL22-90H		○		25x25	150	26	4	22	90-140	Z*GD**
QFGD2525RR22-90H	○			25x25	150	26	4	22	90-140	Z*GD**
QFGD2525LL22-130H		○		25x25	150	26	4	22	130-230	Z*GD**
QFGD2525RR22-130H	●			25x25	150	26	4	22	130-230	Z*GD**
QFHD2525LL13-130H		○		25x25	150	26	5	13	130-200	Z*HD**
QFHD2525RR13-130H	○			25x25	150	26	5	13	130-200	Z*HD**
QFHD2525RR13-185H	○			25x25	150	26	5	13	185-400	Z*HD**
QFHD2525LL22-58H		●		25x25	150	26	5	22	58-96	Z*HD**
QFHD2525RR22-58H	●			25x25	150	26	5	22	58-96	Z*HD**
QFHD2525RR22-86H	○			25x25	150	26	5	22	86-140	Z*HD**
QFHD2525LL22-130H		○		25x25	150	26	5	22	130-200	Z*HD**
QFHD2525RR22-130H	●			25x25	150	26	5	22	130-200	Z*HD**
QFHD2525LL22-185H		○		25x25	150	26	5	22	185-400	Z*HD**
QFHD2525RR22-185H	○			25x25	150	26	5	22	185-400	Z*HD**
QFKD2525RR13-60H	○			25x25	150	26	6	13	60-100	Z*KD**
QFKD2525RR13-88H	○			25x25	150	26	6	13	88-180	Z*KD**
QFKD2525RR15-50H	○			25x25	150		6	15	50-100	Z*KD**
QFKD2525RR22-60H	○			25x25	150	26	6	22	60-100	Z*KD**
QFKD2525LL22-88H		○		25x25	150	26	6	22	88-180	Z*KD**
QFKD2525RR22-88H	○			25x25	150	26	6	22	88-180	Z*KD**
QFKD2525LL22-160H		●		25x25	150	26	6	22	160-400	Z*KD**
QFKD2525RR22-160H	○			25x25	150	26	6	22	160-400	Z*KD**







● Ex stock ○ On demand

* With internal cooling

Spare parts

	Insert	Z*FD**	Z*GD**	Z*HD**	Z*KD**
	H	20-25	20-25	20-25	20-25
	Screw	GB70-85-M6×20 (7.0 Nm)	GB70-85-M6×20 (7.0 Nm)	GB70-85-M6×20 (7.0 Nm)	GB70-85-M6×20 (7.0 Nm)
	Wrench	W50RL	W50RL	W50RL	W50RL

Insert

					
A399	A400	A404	A407	A410	A411

System code > A422

Grade selection > A394

Technical info > A501

Cutting data > A456

Parting & grooving tool holder (axial)

QF*SRR/LL

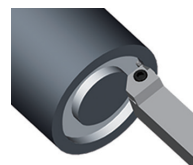
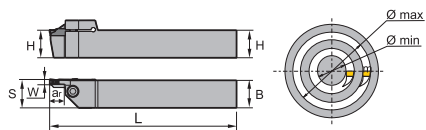
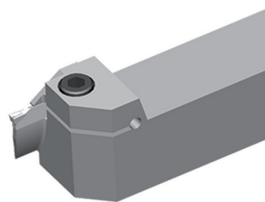

LL Version

Article	*	Stock		Dimensions [mm]						Inserts
		R	L	HxB	L	S	W	ar _{max}	ØD (min-max)	
QFHS2525LL30-185H	●			25x25	150	26	5	30	185-400	Z*HS**
QFHS2525RR30-185H	○			25x25	150	26	5	30	185-400	Z*HS**
QFKS2525RR30-160H	○			25x25	150	26	6	30	160-400	Z*KS**
QFKS2525LL30-160H	○			25x25	150	26	6	30	160-400	ZT*S**

● Ex stock ○ On demand

* With internal cooling

Spare parts

	Insert	Z*HS**	Z*KS**	ZT*S**
	H	25	25	25
	Screw	GB70-85-M6x20 (7.0 Nm)	GB70-85-M6x20 (7.0 Nm)	GB70-85-M6x20 (7.0 Nm)
	Wrench	W50RL	W50RL	W50RL

Insert

A402	A405	A406

System code > A422

Grade selection > A394

Technical info > A501

Cutting data > A456

Parting & grooving tool holder (axial)

QF*DR/L

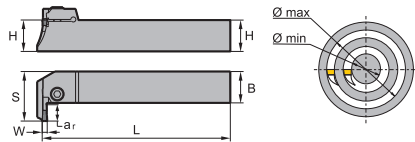
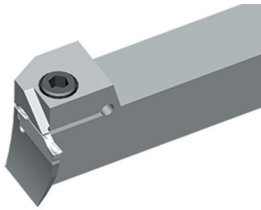

Right hand style

Article	*	Stock		Dimensions [mm]						Inserts
		R	L	HxB	L	S	W	ar _{max}	ØD (min-max)	
QFFD2020R/L10-48L	○ ○			20x20	150	31.5	3	10	48-66	Z*FD**
QFGD2020R/L10-52L	○ ○			20x20	150	31.5	4	10	52-72	Z*GD**
QFFD2020R/L10-74L	● ○			20x20	150	31.5	3	10	74-110	Z*FD**
QFGD2020R/L10-90L	● ○			20x20	150	31.5	4	10	90-140	Z*GD**
QFFD2020R/L10-100L	○ ○			20x20	150	31.5	3	10	100-150	Z*FD**
QFGD2020R/L15-52L	○ ○			20x20	150	36.5	4	15	52-72	Z*GD**
QFFD2525R/L10-48L	● ●			25x25	150	36.5	3	10	48-66	Z*FD**
QFFD2525R/L10-60L	● ○			25x25	150	36.5	3	10	60-80	Z*FD**
QFFD2525R/L10-74L	○ ○			25x25	150	36.5	3	10	74-110	Z*FD**
QFFD2525R/L10-100L	○ ○			25x25	150	36.5	3	10	100-150	Z*FD**
QFGD2525R/L13-52L	○ ○			25x25	150	39.5	4	13	52-72	Z*GD**
QFKD2525R/L13-60L	○ ○			25x25	150	39.5	6	13	60-100	Z*KD**
QFGD2525R/L13-64L	○ ●			25x25	150	39.5	4	13	64-100	Z*GD**
QFGD2525R/L13-90L	○ ○			25x25	150	39.5	4	13	90-140	Z*GD**
QFGD2525R/L13-130L	○ ○			25x25	150	39.5	4	13	130-230	Z*GD**
QFFD2525R/L17-48L	○ ○			25x25	150	43.5	3	17	48-66	Z*FD**
QFFD2525R/L17-60L	○ ○			25x25	150	43.5	3	17	60-80	Z*FD**
QFFD2525R/L17-74L	○ ○			25x25	150	43.5	3	17	74-110	Z*FD**
QFFD2525R/L17-100L	● ○			25x25	150	43.5	3	17	100-150	Z*FD**
QFGD2525R/L22-52L	○ ○			25x25	150	48.5	4	22	52-72	Z*GD**
QFKD2525R/L22-60L	○ ●			25x25	150	48.5	6	22	60-100	Z*KD**
QFGD2525R/L22-64L	○ ○			25x25	150	48.5	4	22	64-100	Z*GD**
QFKD2525R/L22-88L	○ ●			25x25	150	48.5	6	22	88-180	Z*KD**
QFGD2525R/L22-90L	○ ○			25x25	150	48.5	4	22	90-140	Z*GD**
QFGD2525R/L22-130L	● ○			25x25	150	48.5	4	22	130-230	Z*GD**
QFFD2020R/L7-74L	○			20x20	150	28.5	3	7	74-110	Z*FD**
QFFD2020R/L10-60L	●			20x20	150	31.5	3	10	60-80	Z*FD**
QFGD2020R/L10-130L	●			20x20	150	31.5	4	10	130-230	Z*GD**
QFGD2020R/L15-64L	○			20x20	150	36.5	4	15	64-100	Z*GD**
QFGD2020R/L15-90L	○			20x20	150	36.5	4	15	90-140	Z*GD**
QFGD2020R/L15-130L	○			20x20	150	36.5	4	15	130-230	Z*GD**
QFHD2525R/L13-58L	○			25x25	150	39.5	5	13	58-96	Z*HD**
QFHD2525R/L13-86L	●			25x25	150	39.5	5	13	86-140	Z*HD**
QFHD2525R/L13-130L	○ ○			25x25	150	39.5	5	13	130-200	Z*HD**
QFHD2525R/L13-185L	○			25x25	150	39.5	5	13	185-400	Z*HD**
QFHD2525R/L22-58L	○ ○			25x25	150	48.5	5	22	58-96	Z*HD**

System code > A422

Grade selection > A394

Technical info > A501

Cutting data > A456



A

Turning

B

Milling

C

Drilling

D

Technical Information

E

Index

A

Turning



Article	*	Stock		Dimensions [mm]						Inserts 
		R	L	HxB	L	S	W	ar _{max}	ØD (min-max)	
QFHD2525R/L22-86L		○	○	25x25	150	48.5	5	22	86-140	Z*HD**
QFHD2525R/L22-130L		○	○	25x25	150	48.5	5	22	130-200	Z*HD**
QFHD2525R/L22-185L		○	○	25x25	150	48.5	5	22	185-400	Z*HD**
QFKD2525R/L13-88L			○	25x25	150	39.5	6	13	88-180	Z*KD**

● Ex stock ○ On demand

* With internal cooling







B

Milling

Spare parts					
	Insert H	Z*FD** 20-25	Z*GD** 20-25	Z*HD** 20-25	Z*KD** 20-25
	Screw	GB70-85-M6x20 (7.0 Nm)	GB70-85-M6x20 (7.0 Nm)	GB70-85-M6x20 (7.0 Nm)	GB70-85-M6x20 (7.0 Nm)
	Wrench	W50RL	W50RL	W50RL	W50RL

C

Drilling

Insert					
					
A399	A400	A404	A407	A410	A411

D

Technical Information

E

Index

System code > A422

Grade selection > A394

Technical info > A501

Cutting data > A456

Parting & grooving tool holder (axial)

QFHSDR/L

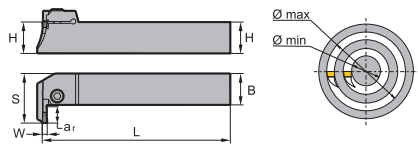
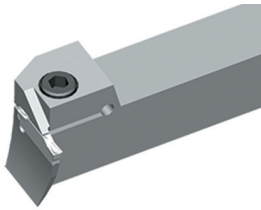



Right hand style

Article	*	Stock		Dimensions [mm]						Inserts
		R	L	HxB	L	S	W	ar _{max}	ØD (min-max)	
QFHS2525R/L30-185L		○	○	25x25	150	56.5	5	30	185-400	Z*HS**

● Ex stock ○ On demand

* With internal cooling

Spare parts

	Insert	Z*HS**
	H	25
	Screw	GB70-85-M6x20 (7.0 Nm)
	Wrench	W50RL

Insert

		
A402	A405	A406

System code > A422

Grade selection > A394

Technical info > A501

Cutting data > A456

Parting & grooving tool holder (axial)

QF**R/L

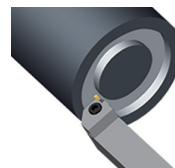
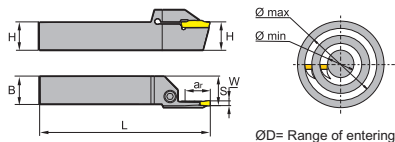
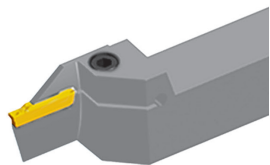

Left hand style

Article	*	Stock		Dimensions [mm]						Inserts
		R	L	HxB	L	S	W	ar _{max}	ØD (min-max)	
QFHS2525R/L30-185H	•	•	25x25	150	26	5	30	185-400	Z*HS**	
QFKS2525R/L30-160H	•	•	25x25	150	26	6	30	160-400	Z*KS**	

• Ex stock ○ On demand

* With internal cooling

Spare parts

	Insert	Z*HS**	Z*KS**
	H	25	25
	Screw	GB70-85-M6x20 (7.0 Nm)	GB70-85-M6x20 (7.0 Nm)
	Wrench	W50RL	W50RL

Insert

A402	A405	A406

System code > A422

Grade selection > A394

Technical info > A501

Cutting data > A456

Parting & grooving tool holder (external)

C40X-Q*DR/L

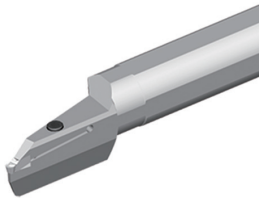

Right hand style

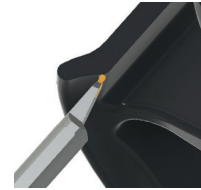
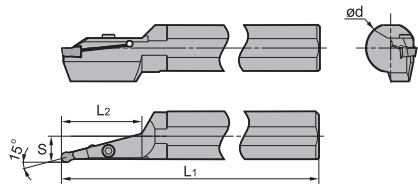

Article	*	Stock		Dimensions [mm]					Inserts
		R	L	ØD	ød	S	L ₁	L ₂	
C40X-QKDR/L60-15A		○	○	160	40	20	320	60	Z*KD**
C40X-QKDR/L75-15A		●	○	160	40	20	320	75	Z*KD**
C40X-QLDR/L65-15A		○	○	160	40	21	320	65	Z*LD**
C40X-QLDR/L80-15A		○	○	160	40	21	320	80	Z*LD**

● Ex stock ○ On demand

* With internal cooling

Spare parts			
	Insert	Z*KD**	Z*LD**
	Ød	32-40	32-40
	Screw	GB70-85-M6×20 (7.0 Nm)	GB70-85-M6×20 (7.0 Nm)
	Wrench	WH50L	WH50L

Insert		
A410	A411	A414

System code > A422

Grade selection > A394

Technical info > A501

Cutting data > A456



A

Turning

B

Milling

C

Drilling

D

Technical Information

E

Index

Parting & grooving tool holder (internal)

C***-Q*DR/L

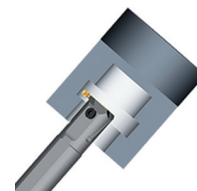
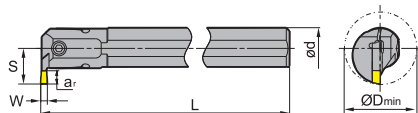
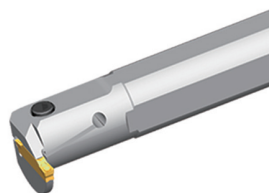

Article	*	Stock		Dimensions [mm]						Inserts
		R	L	ØDmin	ød	L	S	W	ar _{max}	
C16M-QBDR/L04-20	● ○	●	○	20	16	150		2	4	Z*BD**
C20Q-QEDR/L05-27	● ●	●	●	27	20	180		2.5	5	Z*ED**
C25R-QEDR/L07-33	● ●	●	●	33	25	200		2.5	7	Z*ED**
C32S-QEDR/L09-42	● ●	●	●	42	32	250		2.5	9	Z*ED**
C20Q-QFDR/L05-27	● ●	●	●	27	20	0		3	5	Z*FD**
C25R-QFDR/L07-33	● ●	●	●	33	25	200		3	7	Z*FD**
C32S-QFDR/L09-42	● ●	●	●	42	32	250		3	9	Z*FD**
C25R-QGDR/L08-35	● ●	●	●	35	25	200		4	8	Z*GD**
C32S-QGDR/L11-44	● ●	●	●	44	32	250		4	11	Z*GD**
C40T-QGDR/L13-54	● ●	●	●	5	40	300		4	13	Z*GD**
C25R-QHDR/L08-35	● ●	●	●	35	25	200		5	8	Z*HD**
C32S-QHDR/L11-44	● ●	●	●	44	32	250		5	11	Z*HD**
C40T-QHDR/L13-54	● ●	●	●	54	40	300		5	13	Z*HD**
C25R-QKDR/L08-35	○ ●	○	●	35	25	200		6	8	Z*KD**
C32S-QKDR/L11-44	● ●	●	●	44	32	250		6	11	Z*KD**
C40T-QKDR/L13-54	● ●	●	●	54	40	300		6	13	Z*KD**

● Ex stock ○ On demand

* With internal cooling

Spare parts

	Insert	Z*BD**	Z*ED**	Z*ED**	Z*ED**	Z*FD**	Z*FD**	Z*FD**	Z*GD**	Z*GD**	Z*HD**	Z*HD**	Z*KD**	Z*KD**
		Ød	16	20	25	32-40	20	25	32-40	25	32-40	25	32-40	25
	Screw	GB70-85-M5x10 (4.0 Nm)	GB70-85-M4x12 (2.6 Nm)	GB70-85-M5x16 (4.0 Nm)	GB70-85-M6x20 (7.0 Nm)	GB70-85-M4x12 (2.6 Nm)	GB70-85-M5x16 (4.0 Nm)	GB70-85-M6x20 (7.0 Nm)	GB70-85-M5x16 (4.0 Nm)	GB70-85-M6x20 (7.0 Nm)	GB70-85-M5x16 (4.0 Nm)	GB70-85-M6x20 (7.0 Nm)	GB70-85-M5x16 (4.0 Nm)	GB70-85-M6x20 (7.0 Nm)
	Wrench	WH40L	WH30L	WH40L	WH50L	WH30L	WH40L	WH50L	WH40L	WH50L	WH40L	WH50L	WH40L	WH50L







System code > A422

Grade selection > A394

Technical info > A501

Cutting data > A456

Parting & grooving tool holder (internal)

Insert						
						
A399	A400	A404	A407	A410	A411	A414

A

Turning

B

Milling

C

Drilling

D

Technical
Information

E

Index

System code > A422

Grade selection > A394

Technical info > A501

Cutting data > A456

Parting & grooving tool holder (external)

QE**R/L-DGC

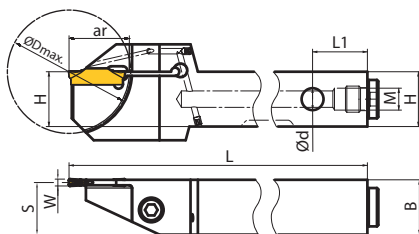
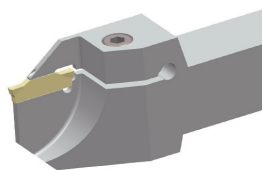

Article	*	Stock		Dimensions [mm]									Inserts
		R	L	HxB	ød	L	S	L ₁	W	ar _{max}	ØD _{max}	M	
QEED1616R/L20-DGC	*	○	○	16x16	G1/8	96	15	20	2	20	40	G1/8	Z*BD**
QEED1616R/L30-DGC	*	●	●	16x16	G1/8	105	15	20	2	30	60	G1/8	Z*BD**
QEED2020R/L20-DGC	*	○	○	20x20	G1/8	111	19	20	2	20	40	G1/8	Z*BD**
QEED2020R/L30-DGC	*	●	●	20x20	G1/8	120	19	20	2	30	60	G1/8	Z*BD**
QEED2525R/L20-DGC	*	○	○	25x25	G1/8	126	24	20	2	20	40	G1/8	Z*BD**
QEED2525R/L30-DGC	*	●	●	25x25	G1/8	135	24	20	2	30	60	G1/8	Z*BD**
QEED1616R/L20-DGC	*	○	○	16x16	G1/8	96	14.75	20	2.5	20	40	G1/8	Z*ED**
QEED1616R/L30-DGC	*	●	●	16x16	G1/8	105	14.75	20	2.5	30	60	G1/8	Z*ED**
QEED2020R/L20-DGC	*	○	○	20x20	G1/8	111	18.75	20	2.5	20	40	G1/8	Z*ED**
QEED2020R/L30-DGC	*	●	○	20x20	G1/8	120	18.75	20	2.5	30	60	G1/8	Z*ED**
QEED2525R/L20-DGC	*	○	○	25x25	G1/8	126	23.75	20	2.5	20	40	G1/8	Z*ED**
QEED2525R/L30-DGC	*	○	○	25x25	G1/8	135	23.75	20	2.5	30	60	G1/8	Z*ED**
QEFD1616R/L20-DGC	*	○	○	16x16	G1/8	96	14.5	20	3	20	40	G1/8	Z*FD**
QEFD1616R/L30-DGC	*	●	●	16x16	G1/8	105	14.5	20	3	30	60	G1/8	Z*FD**
QEFD2020R/L20-DGC	*	○	○	20x20	G1/8	111	18.5	20	3	20	40	G1/8	Z*FD**
QEFD2020R/L30-DGC	*	●	●	20x20	G1/8	120	18.5	20	3	30	60	G1/8	Z*FD**
QEFD2525R/L20-DGC	*	○	○	25x25	G1/8	126	23.5	20	3	20	40	G1/8	Z*FD**
QEFD2525R/L30-DGC	*	○	○	25x25	G1/8	135	23.5	20	3	30	60	G1/8	Z*FD**
QEGD1616R/L20-DGC	*	○	○	16x16	G1/8	96	14	20	4	20	40	G1/8	Z*GD**
QEGD1616R/L30-DGC	*	●	●	16x16	G1/8	105	14	20	4	30	60	G1/8	Z*GD**
QEGD2020R/L20-DGC	*	○	○	20x20	G1/8	111	18	20	4	20	40	G1/8	Z*GD**
QEGD2020R/L30-DGC	*	○	○	20x20	G1/8	120	18	20	4	30	60	G1/8	Z*GD**
QEGD2525R/L20-DGC	*	○	○	25x25	G1/8	126	23	20	4	20	40	G1/8	Z*GD**
QEGD2525R/L30-DGC	*	○	○	25x25	G1/8	135	23	20	4	30	60	G1/8	Z*GD**

● Ex stock ○ On demand

* With internal cooling

Spare parts

	Insert	Z*BD**	Z*ED**	Z*FD**	Z*GD**
		H	16-25	16-25	16-25
	Grub screw	PT1/8x4	PT1/8x4	PT1/8x4	PT1/8x4
	Screw	GB70-85-M5x20 (4.0 Nm)	GB70-85-M5x20 (4.0 Nm)	GB70-85-M5x20 (4.0 Nm)	GB70-85-M5x20 (4.0 Nm)
	Wrench	WH40L	WH40L	WH40L	WH40L
	Wrench	WH50L	WH50L	WH50L	WH50L





System code > A422

Grade selection > A394

Technical info > A501

Cutting data > A456

Parting & grooving tool holder (external)

Insert			
			
A399	A400	A404	A407

A

Turning

B

Milling

C

Drilling

D

Technical
Information

E

Index

System code > A422

Grade selection > A394

Technical info > A501

Cutting data > A456

Parting & grooving tool holder (external)

QE**R/L-DGSC

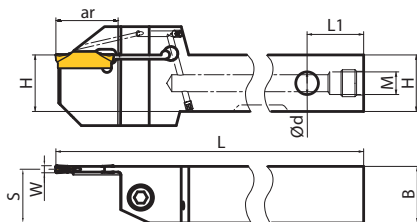
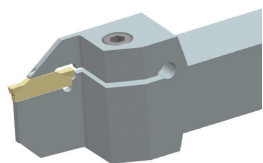

Article	*	Stock		Dimensions [mm]								Inserts
		R	L	HxB	ød	L	S	L ₁	W	ar _{max}	M	
QEED1616R/L30-DGSC	*	●	●	16x16	G1/8	105	14.75	20	2.5	30	G1/8	Z*ED**
QEED2020R/L30-DGSC	*	●	○	20x20	G1/8	120	18.75	20	2.5	30	G1/8	Z*ED**
QEED2525R/L30-DGSC	*	○	○	25x25	G1/8	135	23.75	20	2.5	30	G1/8	Z*ED**
QEFD1616R/L30-DGSC	*	●	●	16x16	G1/8	105	14.5	20	3	30	G1/8	Z*FD**
QEFD2020R/L30-DGSC	*	○	○	20x20	G1/8	120	18.5	20	3	30	G1/8	Z*FD**
QEFD2525R/L30-DGSC	*	○	○	25x25	G1/8	135	23.5	20	3	30	G1/8	Z*FD**
QEGD1616R/L30-DGSC	*	○	○	16x16	G1/8	105	14	20	4	30	G1/8	Z*GD**
QEGD2020R/L30-DGSC	*	○	○	20x20	G1/8	120	18	20	4	30	G1/8	Z*GD**
QEGD2525R/L30-DGSC	*	○	○	25x25	G1/8	135	23	20	4	30	G1/8	Z*GD**
QEHD2525R/L30-DGSC	*	○	○	25x25	G1/8	135	22.5	20	5	30	G1/8	Z*HD**
QEKD2525R/L30-DGSC	*	○	○	25x25	G1/8	135	22	20	6	30	G1/8	Z*KD**

● Ex stock ○ On demand

* With internal cooling

Spare parts

Insert H	Z*ED**	Z*FD**	Z*GD**	Z*HD**	Z*KD**
	16-25	16-25	20-25	20-25	20-25
Grub screw	PT1/8x4	PT1/8x4	PT1/8x4	PT1/8x4	PT1/8x4
Screw	GB70-85-M5x20 (4.0 Nm)	GB70-85-M5x20 (4.0 Nm)	GB70-85-M5x20 (4.0 Nm)	GB70-85-M6x20 (7.0 Nm)	GB70-85-M6x20 (7.0 Nm)
Wrench	WH40L	WH40L	WH40L	WH50L	WH50L
Wrench	WH50L	WH50L	WH50L	WH50L	WH50L

Insert

A399	A400	A404	A407

System code > A422

Grade selection > A394

Technical info > A501

Cutting data > A456

Parting & grooving tool holder (external)

QE**R/L-SC

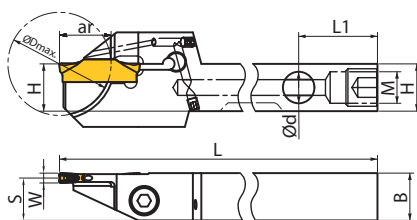
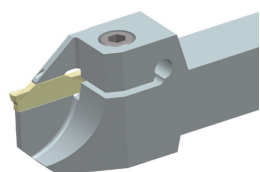

Article	*	Stock		Dimensions [mm]									Inserts
		R	L	HxB	ød	L	S	L ₁	W	ar _{max}	ØD _{max}	M	
QEAD1010R/L10-SC	*	○	○	10x10	G1/16	125	9	20	1.5	10	20	G1/16	Z*AD**
QEAD1212R/L13-SC	*	○	○	12x12	G1/8	125	12	20	1.5	13	26	G1/8	Z*AD**
QEAD1616R/L13-SC	*	○	○	16x16	G1/8	125	15	20	1.5	13	26	G1/8	Z*AD**
QEAD2020R/L13-SC	*	○	○	20x20	G1/8	125	19	20	1.5	13	26	G1/8	Z*AD**
QEBD1010R/L10-SC	*	○	○	10x10	G1/16	110	9	20	2	10	20	G1/16	Z*BD**
QEBD1212R/L13-SC	*	●	●	12x12	G1/8	110	11	20	2	13	26	G1/8	Z*BD**
QEBD1616R/L13-SC	*	●	●	16x16	G1/8	110	15	20	2	13	26	G1/8	Z*BD**
QEBD2020R/L13-SC	*	○	○	20x20	G1/8	110	19	20	2	13	26	G1/8	Z*BD**
QEED1010R/L10-SC	*	○	○	10x10	G1/16	110	8.75	20	2.5	10	20	G1/16	Z*ED**
QEED1212R/L13-SC	*	●	●	12x12	G1/8	110	10.75	20	2.5	13	26	G1/8	Z*ED**
QEED1616R/L17-SC	*	●	●	16x16	G1/8	110	14.75	20	2.5	17	34	G1/8	Z*ED**
QEED2020R/L17-SC	*	●	●	20x20	G1/8	110	18.75	20	2.5	17	34	G1/8	Z*ED**
Qefd1212R/L13-SC	*	●	●	12x12	G1/8	110	10.5	20	3	13	26	G1/8	Z*FD**
Qefd1616R/L17-SC	*	●	●	16x16	G1/8	110	14.5	20	3	17	34	G1/8	Z*FD**
Qefd2020R/L22-SC	*	●	●	20x20	G1/8	110	18.5	20	3	22	44	G1/8	Z*FD**

● Ex stock ○ On demand

* With internal cooling

Spare parts

Insert	H	Z*AD**	Z*AD**	Z*AD**	Z*AD**	Z*BD**	Z*BD**	Z*BD**	Z*ED**	Z*ED**	Z*ED**	Z*FD**	Z*FD**
		10	12	16	20	10	12	16-20	10	12	16-20	12	16-20
	Grub screw	PT1/16x6	PT1/8x4	PT1/8x4	PT1/8x4	PT1/16x6	PT1/8x4	PT1/8x4	PT1/16x6	PT1/8x4	PT1/8x4	PT1/8x4	PT1/8x4
	Screw	GB70-85-M4x12 (2.6 Nm)	GB70-85-M4x12 (2.6 Nm)	GB70-85-M4x14	GB70-85-M4x18	GB70-85-M4x12 (2.6 Nm)	GB70-85-M4x12 (2.6 Nm)	GB70-85-M6x20 (7.0 Nm)	GB70-85-M4x12 (2.6 Nm)	GB70-85-M4x12 (2.6 Nm)	GB70-85-M6x20 (7.0 Nm)	GB70-85-M4x12 (2.6 Nm)	GB70-85-M5x20 (4.0 Nm)
	Wrench	WH30L	WH30L	WH30L	WH30L	WH30L	WH30L	WH40L	WH30L	WH30L	WH40L	WH30L	WH40L
	Wrench	WH40L	WH50L	WH50L	WH50L	WH40L	WH50L	WH50L	WH40L	WH50L	WH50L	WH50L	WH50L

System code > A422

Grade selection > A394





Technical info > A501

Cutting data > A456



A

Parting & grooving tool holder (external)

Insert			
			
A399	A400	A404	A407

Turning

B

Milling

C

Drilling

D

Technical
Information

E

Index

System code > A422

Grade selection > A394

Technical info > A501

Cutting data > A456

Accessoires

Coolant hose



Article	Dimensions [mm]			Stock
	L	Th1	Th2	
HOSE G1/8-7/16/200BS	200	G1/8"-28 BSPP	G1/8"-28 BSPP	○
HOSE G1/8-7/16/300BS	300	G1/8"-28 BSPP	G1/8"-28 BSPP	○
HOSE G1/8-7/16/200BB	200	G1/8"-28 BSPP	G1/8"-28 BSPP	○
HOSE G1/8-7/16/300BB	300	G1/8"-28 BSPP	G1/8"-28 BSPP	○

● Ex stock ○ On demand

Coolant connection

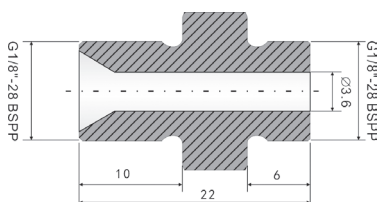

Article	Stock
NIPPLE G1/8- G1/8	○

● Ex stock ○ On demand

A

Turning

B

Milling

C

Drilling

D

Technical Information

E

Index

External tool holders – QC series

GQC R 20 20 K 22 – 15

1 2 3 4 5 6 7

Series	Type		Height [mm]		Width [mm]		Length [mm]	
	Code	Description	Code	Description	Code	Description	Code	Description
	R	Right	16	16	16	16	K	125
L	Left	20	20	20	20	M	150	
		25	25	25	25			

1

2

3

4

5

Cutting edge length [mm]	
Code	I.C
11	6,35
16	9,252
22	12,70

6

Cutting width range [mm]		
Code	Insert size	
15	0,5 ≤ S < 1,8 (QC16***)	1,0 ≤ S < 2,3 (QC22***)
25	1,8 ≤ S < 3,0 (QC16***)	2,3 ≤ S < 3,3 (QC22***)
35	–	3,3 ≤ S ≤ 4,8 (QC22***)

7

Boring bars – QC series

S 20 K – QC 16 15 R 25

1 2 3 4 5 6 7 8

Shank type	
Code	Material
S	Steel shank
C	Solid carbide shank
A	Solid carbide shank (IC)

1

Diameter [mm]	
Code	Description
16	16
20	20
25	25

2

Length [mm]	
Code	Description
H	100
K	125
M	150

3

Series	Cutting edge length [mm]	
	Code	I.C
	11	6,35
16	9,252	
22	12,70	

4

5

Cutting width range [mm]			
Code	Insert size		
15	0,5 ≤ S < 1,8 (QC11***)	0,5 ≤ S < 1,8 (QC16***)	1,0 ≤ S < 2,3 (QC22***)
25	1,8 ≤ S < 3,0 (QC11***)	1,8 ≤ S < 3,0 (QC16***)	2,3 ≤ S < 3,3 (QC22***)
35	–	–	3,3 ≤ S ≤ 4,8 (QC22***)

6

Cutting direction	
Code	Description
R	Right
L	Left

7

Starting diameter [mm]			
Code	∅	Code	∅
16	16	25	25
20	20	35	35

8

Grooving (external)

GQC**R/L

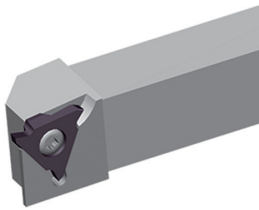

Right hand style

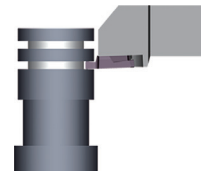
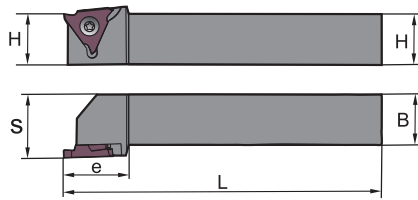



Article	*	Stock		Dimensions [mm]						Inserts
		R	L	H	L	S	e	B	Width	
GQCR/L1616K16-15	●	●	16	125	21	25.5	16	0.5-1.80	QC16R/L 050-180	
GQCR/L2020K16-15	○	●	20	125	25	25.5	20	0.5-1.80	QC16R/L 050-180	
GQCR/L2525M16-15	○	●	25	150	30	25.5	25	0.5-1.80	QC16R/L 050-180	
GQCR/L1616K16-25	●	●	16	125	21	25.5	16	1.8-3.0	QC16R/L 180-300	
GQCR/L2020K16-25	○	●	20	125	25	25.5	20	1.8-3.0	QC16R/L 180-300	
GQCR/L2525M16-25	○	●	25	150	30	25.5	25	1.8-3.0	QC16R/L 180-300	
GQCR/L2020K22-15	○	●	20	125	25	25.5	20	1.0-2.3	QC22R/L 100-230	
GQCR/L2525M22-15	○	●	25	150	30	25.5	25	1.0-2.3	QC22R/L 100-230	
GQCR/L2020K22-25	○	●	20	125	25	25.5	20	2.3-3.3	QC22R/L 230-330	
GQCR/L2525M22-25	○	●	25	150	30	25.5	25	2.3-3.3	QC22R/L 230-330	
GQCR/L2020K22-35	●	●	20	125	25	25.5	20	3.3-4.8	QC22R/L 330-480	
GQCR/L2525M22-35	●	●	25	150	30	25.5	25	3.3-4.8	QC22R/L 330-480	

● Ex stock ○ On demand

* With internal cooling

Spare parts

	Insert	QC16R/L 050-180	QC16R/L 180-300	QC22R/L 100-230	QC22R/L 230-330	QC22R/L 330-480
	H	16-32	16-32	16-32	16-32	16-32
	Screw	I60M3.5×10 (2.7 Nm)	I60M3.5×10 (2.7 Nm)	I60M5×13 (6.7 Nm)	I60M5×13 (6.7 Nm)	I60M5×13 (6.7 Nm)
	Wrench (shim)	WT15IP	WT15IP	WT20IP	WT20IP	WT20IP

Insert



Medium Cut

A417

S_QCR/L

S*K-QC**R/L

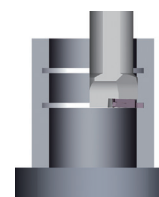
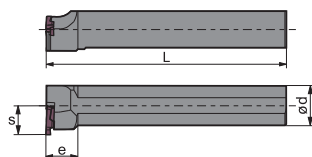
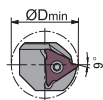
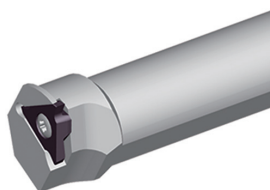

Right hand style

Article	*	Stock		Dimensions [mm]						Inserts
		R	L	ØDmin	ød	L	S	e	Width	
S16H-QC1115R/L20	●	●		21	16	100	11.5	12	0.5-1.80	QC11R/L 050-180
S20K-QC1115R/L16	●	●		16	20	125	11.1	40	0.5-1.80	QC11R/L 050-180
S16H-QC1125R/L20	●	●		21	16	100	11.5	12	1.8-3.0	QC11R/L 180-300
S20K-QC1125R/L16	○	○		16	20	125	11.1	40	1.8-3.0	QC11R/L 180-300
S20M-QC1615R/L25	○	●		26	20	150	12.5	15	0.5-1.80	QC16R/L 050-180
S20M-QC1625R/L25	●	●		26	20	150	12.5	15	1.8-3.0	QC16R/L 180-300
S25M-QC2215R/L35	●	●		35	25	150	18.2	15	1.0-2.3	QC22R/L 100-230
S25M-QC2225R/L35	●	●		35	25	150	18.2	20	2.3-3.3	QC22R/L 230-330
S25M-QC2235R/L35	○	●		35	25	150	18.2	20	3.3-4.8	QC22R/L 330-480

● Ex stock ○ On demand

* With internal cooling

Right-hand tool holder for left-hand grooving insert.

Left-hand tool holder for right-hand grooving insert.

Spare parts

	Insert	QC11R/L 050-180	QC11R/L 180-300	QC16R/L 050-180	QC16R/L 180-300	QC22R/L 100-230	QC22R/L 230-330	QC22R/L 330-480
	ød	16-20	16-20	20	20	25	25	25
	Screw	I60M2.5×6.5 (1.0 Nm)	I60M2.5×6.5 (1.0 Nm)	I60M3.5×10 (2.7 Nm)	I60M3.5×10 (2.7 Nm)	I60M5×13 (6.7 Nm)	I60M5×13 (6.7 Nm)	I60M5×13 (6.7 Nm)
	Wrench (shim)	WT07IP	WT07IP	WT15IP	WT15IP	WT20IP	WT20IP	WT20IP

Insert



Medium Cut

A417

System code > A452

Grade selection > A394

Technical info > A501

Cutting data > A456

Parting & grooving inserts

	Material group	Composition / structure / heat treatment		Brinell hardness HB	Machining group	Starting values for cutting speed v_c [m/min]			
						HC (CVD)		HC (PVD)	
						YBC252	YBG102	YBG105	
A Turning	P Unalloyed steel	approx. 0,15 % C	annealed	125	1	190			
		approx. 0,45 % C	annealed	190	2	175			
		approx. 0,45 % C	tempered	250	3	145			
		approx. 0,75 % C	annealed	270	4	140			
		approx. 0,75 % C	tempered	300	5	135			
	B Milling	Low-alloyed steel		annealed	180	6	170		
				tempered	275	7	125		
				tempered	300	8	115		
				tempered	350	9	105		
	C Drilling	High-alloyed steel and high-alloyed tool steel		annealed	200	10	125		
			hardened and tempered	325	11	95			
D Technical Information	M Stainless steel	ferritic/martensitic	annealed	200	12	165	165	170	
		martensitic	tempered	240	13	135	135	140	
		austenitic	quench hardened	180	14	155	155	160	
		austenitic-ferritic		230	15	135	135	140	
E Index	Grey cast iron	perlitic/ferritic		180	16	240			
		perlitic (martensitic)		260	17	185			
	Cast iron with spheroidal graphite	ferritic		160	18	220			
		perlitic		250	19	165			
	Malleable cast iron	ferritic		130	20	175			
		perlitic		230	21	165			
F Index	Aluminium wrought alloys	cannot be hardened		60	22				
		hardenable	hardened	100	23				
	Cast aluminium alloys	$\leq 12\% \text{ Si}$, cannot be hardened		75	24				
		$\leq 12\% \text{ Si}$, hardenable	hardened	90	25				
		$> 12\% \text{ Si}$, cannot be hardened		130	26				
	Copper and copper alloys (bronze/brass)	machining steel, PB > 1%			110	27			
		CuZn, CuSnZn			90	28			
CuSn, Pb-free copper, electrolytic copper			100	29					
G Index	Heat-resistant alloys	Fe-based alloys	annealed	200	30		95	100	
			hardened	280	31		50	50	
		Ni or Co base	annealed	250	32		80	80	
			hardened	350	33		70	70	
	Titanium alloys	cast		320	34		70	70	
pure titanium			R_m 400	35		145	150		
H Index	Hardened steel		hardened and tempered	55 HRC	37				
			hardened and tempered	60 HRC	38				
I Index	Hard cast iron		cast	400	39				
	Hardened cast iron		hardened and tempered	55 HRC	40				
J Index	X Non-metallic materials	Thermoplasts			41				
		Thermosetting plastics			42				
		Plastic, glass-fibre reinforced GFRP			43				
		Plastic, carbon fibre reinforced CFRP			44				
		Graphite			45				
		Wood			46				

Note: The given cutting values are guide values, which were determined under ideal conditions.
The values have to be adapted in individual cases.
For examples of material for cutting tool groups view page D11.

THREADING

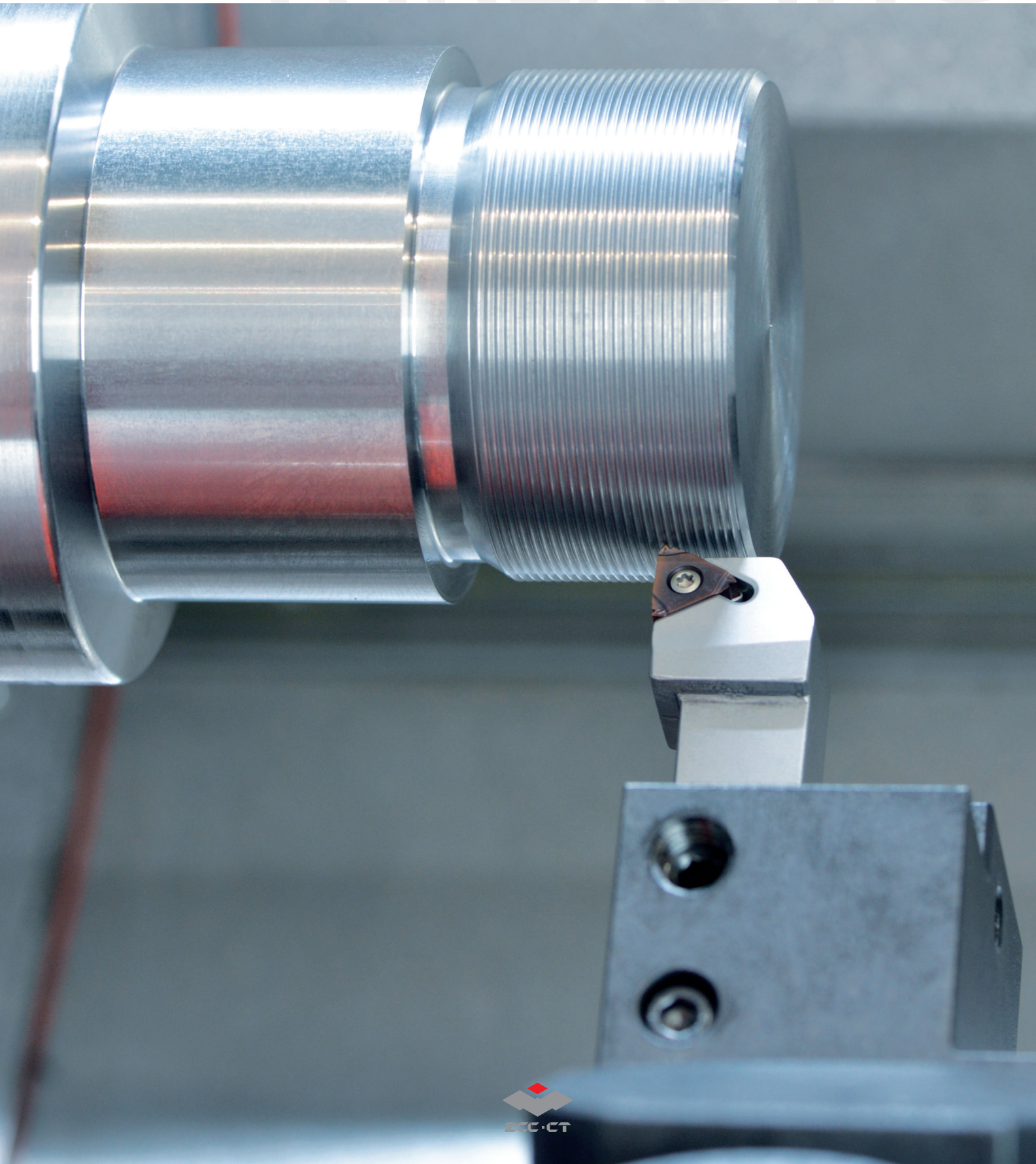

A

Turning

B

Milling

C

Drilling











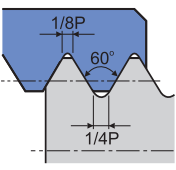

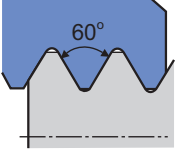

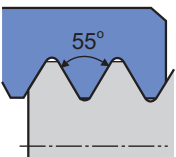

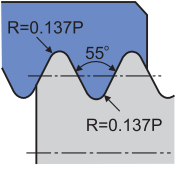
DTechnical
Information**E**

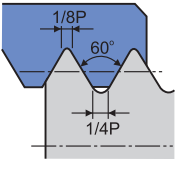

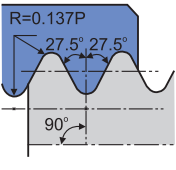

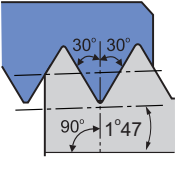

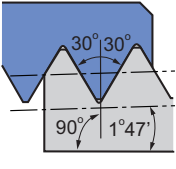



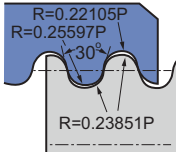

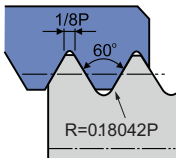

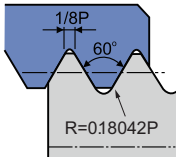

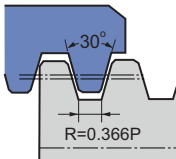
Index

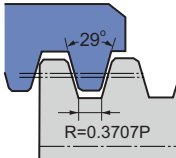
Threading

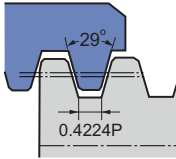
System overview	A460-A463
Grade overview	A464
Application fields of grades	A465
System code - inserts	A466
Inserts	A467-A491
System code - threading tool holders	A492
Threading tool holders	A493-A499
Recommended cutting data	A500
Trouble shooting	A504
Technical Information	A511-A512
Special tools	A513

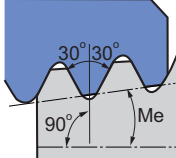

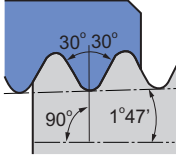
A	Turning	B	Milling	C	Drilling	D Technical Information	E	Index					
Thread types	Profile	Sectional drawing	Insert	Internal thread pitch mm (TPI)	External thread pitch mm (TPI)	Page							
ISO metric coarse thread 60° full profile	GM			0,5-6,0	0,5-6,0	A467	60° partial profile	60°			0,5-5,0 (5-48)	0,5-5,0 (5-48)	A469
55° partial profile	55°			0,5-5,0 (5-48)	0,5-5,0 (5-48)	A470	Whitworth	W			(8-16)	(8-16)	A471
UN unified conventional thread 60° full profile	UN			(8-20)	(8-20)	A472	BSPT Whitworth taper pipe thread	BSPT			(11-28)	11-28	A473
NPT American taper pipe thread	NPT			(8-27)	(8-27)	A474	NPTF dryseal American taper pipe thread 60°	NPTF			(8-27)	(8-27)	A475

Thread types	Profile	Sectional drawing	Insert	Internal thread pitch mm (TPI)	External thread pitch mm (TPI)	Page
R knuckle thread 30°	R			(6-10)	(6-10)	A476
MJ thread for aerospace	MJ			---	1,5-2,0	A477
UNJ unified screw thread	UNJ			---	(8-32)	A478
TR metrical ISO trapezoidal thread 30°	Tr			1,5-3,0	1,5-3,0	A479
ACME American national thread 29°	AC			(8-16)	(8-16)	A480
STUB-ACME thread	STAC			(8-16)	(8-16)	A481
API 60° thread	AP			4-5	(4-5)	A482
API round thread	RD			8-10	(8-10)	A483

A	Turning
B	Milling
C	Drilling
D	Technical Information
E	Index

A
Turning

B
Milling

C
Drilling

D
Technical Information

E
Index

Thread types	Profile	Sectional drawing	Insert	Internal thread pitch mm (TPI)	External thread pitch mm (TPI)	Page
API American buttress thread	BUT			(5)	(5)	A484
ISO metric coarse thread 60° full profile (thin type)	GM			0,5-3,0	0,5-3,0	A485
60° partial profile (thin type)	60°			0,5-3,0 (8-48)	0,5-3,0 (8-48)	A486
55° partial profile (thin type)	55°			0,5-3,0 (8-48)	0,5-3,0 (8-48)	A487
Whitworth (thin type)	W			(8-16)	(8-16)	A488
UN unified conventional thread 60° full profile (thin type)	UN			(8-24)	(8-20)	A489
BSPT Whitworth taper pipe thread (thin type)	BSPT			(11-28)	(11-28)	A490
NPT American taper pipe thread (thin type)	NPT			(8-27)	(8-27)	A491

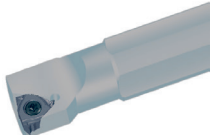
Type	Tool holder	Dimensions [mm]	Page
External thread holder		16×16×100 20×20×125 25×25×150 32×25×170 32×32×170 40×40×250	A493
Internal thread holder		16×125×12 16×150×16 16×150×20 20×150×25 20×180×25 25×150×32 32×200×40 32×250×40 40×300×50 50×350×63	A495
External thread holder (Thin Type)		16×16×100 32×25×170 20×20×125 32×32×170 25×25×150	A497
Internal thread holder (Thin Type)		16×150×20 32×200×40 20×180×25 32×250×40 25×150×32	A498

A

Turning

B

Milling

C

Drilling

D

Technical
Information

E

Index

Threading

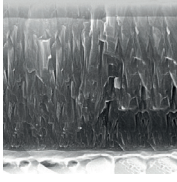
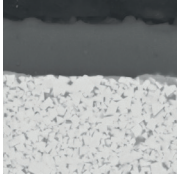
Grade	ISO	Micro structure	Grade description
YBG201	P10 - P30 M10 - M30		PVD coated P10–P30/M10–M30 carbide substrate for finishing to medium application of steel and stainless steel. Good wear resistance in a wide application field.
YBG205	P10 - P30 M20 - M40 S15-S25		PVD multilayer coated P10–P30/M20–M40/S15–S25 carbide substrate for finishing to medium machining of stainless steel, super alloys and steel (milling). Excellent wear resistance and thermal stability in a wide range of applications.

A

Turning

B

Milling

C

Drilling

D

Technical
Information

E

Index

Application fields of grades – threading

	ISO	HC ¹ (CVD)	HC ¹ (PVD)	HT	HC ²	Ceramic	HW	CBN	PCD
P	P01								
	P10		YBG205						
	P20								
	P30								
	P40								
M	M01								
	M10		YBG205						
	M20								
	M30								
	M40								
K	K01								
	K10								
	K20								
	K30								
N	N01								
	N10								
	N20								
	N30								
S	S01								
	S10		YBG205						
	S20								
	S30								
H	H01								
	H10								
	H20								
	H30								

P	Steel
M	Stainless steel
K	Cast iron

N	Non-ferrous metals
S	Heat-resistant alloys
H	Hardened materials

HC ¹	Coated carbide
HT	Uncoated cermet
HC ²	Coated cermet
HW	Uncoated carbide

A

Turning

B

Milling

C

Drilling

D

Technical Information

E

Index

R T 22. 01 W – 3.50 GM (P) (B)

1 2 3 4 5 6 7 8 9

A

Turning

Type	
Code	Description
R	Right
L	Left

1

Insert shape	
T 	Z Special

2

Insert size [mm]	
Code	I.C
11	6,35
16	9,252
22	12,70

3

B

Milling

Teeth per cutting edge	
Code	Description
01	1
02	2

4

Application	
Code	Description
W	External thread
N	Internal thread

5

Pitch		
Code	Pitch range (part profile)	
A	0,5 – 1,5 mm	48 – 16 (TPI)
AG	0,5 – 3,0 mm	48 – 8 (TPI)
G	1,75 – 3,0 mm	14 – 8 (TPI)
N	3,5 – 5,0 mm	7 – 5 (TPI)
Pitch range [mm] (full profile)		
0,50 0,75 1,00 1,25 1,50		
1,75 2,00 2,50 3,00 3,50		
4,00 4,50 5,00 5,50 6,00		
Pitch range (TPI) (full profile)		
4 5 6 8		
10 11 11,5 12		
14 16 18 19		
20 24 27 28		

6

C

Drilling

D

Technical Information

Thread profile	
Code	Description
GM	ISO metric coarse thread 60°
60	Partial profile 60°
55	Partial profile 55°
W	Whitworth
UN	Unified conventional thread
BSPT	Whitworth taper pipe thread
NPT	American taper pipe thread
NPTF	Dryseal American taper pipe thread
R	Knuckle thread 30°
MJ	Thread for aerospace
UNJ	Unified screw thread
TR	Metrical ISO trapezoidal thread
AC	American national thread
STAC	STUB-ACME thread
AP	API 60° thread
RD	API round thread
BUT	American buttress thread

7

Chip breaker

8

Insert thickness [mm]

Code	Description
B	Thin type

9

E

Index

R/LT**N/W	I.C	S	d
11	6.35	3.18	2.8
16	9.525	3.97	4.4
22	12.7	5.56	5.5

Threading inserts

ISO metric coarse thread 60° full profile

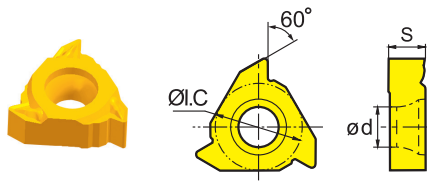

External right hand
Internal left hand

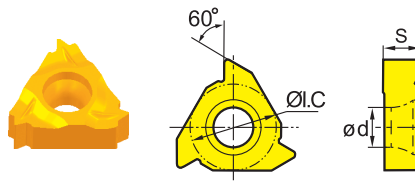

Internal right hand
External left hand

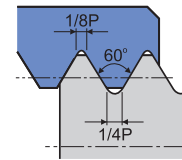

ISO 965-1980 DIN 13
GB-T 197-2003 Tolerance: 6g-6H

ISO	Pitch (mm)	External	HC ¹ (PVD)				Internal	HC ¹ (PVD)			
			YBG201	YBG205				YBG201	YBG205		
11	0.50	-					RT11.01N-0.50GM	○			
11		-					LT11.01N-0.50GM	○			
11	0.75	-					RT11.01N-0.75GM	●			
11		-					LT11.01N-0.75GM	○			
11	1.00	-					RT11.01N-1.00GM	○ ●			
11		-					LT11.01N-1.00GM	●			
11	1.25	-					RT11.01N-1.25GM	●			
11		-					LT11.01N-1.25GM	●			
11	1.50	-					RT11.01N-1.50GM	○ ●			
11		-					LT11.01N-1.50GM	●			
11	1.75	-					RT11.01N-1.75GM	○			
11		-					LT11.01N-1.75GM	●			
11	2.00	-					RT11.01N-2.00GM	○ ●			
11		-					LT11.01N-2.00GM	●			
16	0.50	-					RT16.01N-0.50GM	○			
16		-					LT16.01N-0.50GM	○			
16	0.75	-					RT16.01N-0.75GM	○			
16		-					LT16.01N-0.75GM	○			
16	1.00	RT16.01W-1.00GM	○ ●				RT16.01N-1.00GM	○			
16		LT16.01W-1.00GM	●				LT16.01N-1.00GM	●			
16	1.25	RT16.01W-1.25GM	○ ●				RT16.01N-1.25GM	○			
16		LT16.01W-1.25GM	●				LT16.01N-1.25GM	●			
16	1.50	RT16.01W-1.50GM	○ ●				RT16.01N-1.50GM	●			
16		LT16.01W-1.50GM	●				LT16.01N-1.50GM	●			
16	1.75	RT16.01W-1.75GM	●				RT16.01N-1.75GM	○			
16		LT16.01W-1.75GM	●				LT16.01N-1.75GM	●			
16	2.00	RT16.01W-2.00GM	○ ●				RT16.01N-2.00GM	○ ●			

● Ex stock ○ On demand

HC¹ Coated carbide

System code > A466

Grade selection > A465

Technical info > A501

Cutting data > A500



A

Turning

B

Milling

C

Drilling

D

Technical Information

E

Index

R/LT**N/W	I.C	S	d
11	6.35	3.18	2.8
16	9.525	3.97	4.4
22	12.7	5.56	5.5

Threading inserts

ISO metric coarse thread 60° full profile

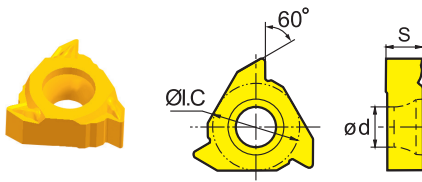

External right hand
Internal left hand

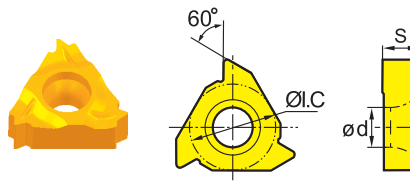

Internal right hand
External left hand

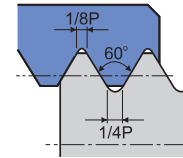



ISO 965-1980 DIN 13
GB-T 197-2003 Tolerance: 6g-6H

ISO	Pitch (mm)	External	HC ¹ (PVD)					Internal	HC ¹ (PVD)					
			YBG201	YBG205					YBG201	YBG205				
16	2.00	LT16.01W-2.00GM	●					LT16.01N-2.00GM	●					
16	2.50	RT16.01W-2.50GM	○	●				RT16.01N-2.50GM	○	●				
16		LT16.01W-2.50GM	●					LT16.01N-2.50GM	●					
16	3.00	RT16.01W-3.00GM	○	●				RT16.01N-3.00GM	○	●				
16		LT16.01W-3.00GM	●					LT16.01N-3.00GM	●					
22	3.50	RT22.01W-3.50GM	○					RT22.01N-3.50GM	○	●				
22		LT22.01W-3.50GM	●					LT22.01N-3.50GM	●					
22	4.00	RT22.01W-4.00GM	○	●				RT22.01N-4.00GM	●					
22		LT22.01W-4.00GM	●					LT22.01N-4.00GM	●					
22	4.50	RT22.01W-4.50GM	○					RT22.01N-4.50GM	○	●				
22		LT22.01W-4.50GM	○					LT22.01N-4.50GM	●					
22	5.00	RT22.01W-5.00GM	○					RT22.01N-5.00GM	○					
22		LT22.01W-5.00GM	●					LT22.01N-5.00GM	●					
22	5.50	RT22.01W-5.50GM	○					RT22.01N-5.50GM	○					
22		LT22.01W-5.50GM	○					LT22.01N-5.50GM	●					
22	6.00	RT22.01W-6.00GM	○	●				RT22.01N-6.00GM	○	●				
22		LT22.01W-6.00GM	●					LT22.01N-6.00GM	●					

● Ex stock ○ On demand

HC¹ Coated carbide

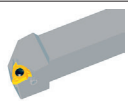
Tool holders

SWR/L	SNR/L
	
A493-A494	A495-A496

System code > A466

Grade selection > A465

Technical info > A501

Cutting data > A500

Threading inserts

R/LT**N/W	I.C	S	d
16	9.525	3.97	4.4
22	12.7	5.56	5.5

60° partial profile

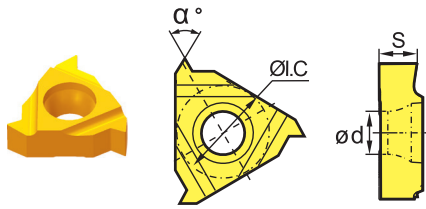

External right hand
Internal left hand

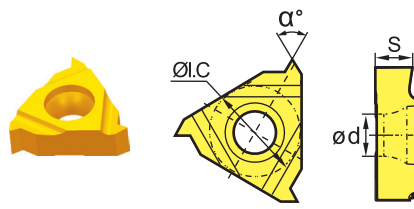

Internal right hand
External left hand

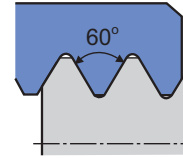



ISO	Pitch (mm)	External	HC ¹ (PVD)					Internal	HC ¹ (PVD)					
			YBG201	YBG205					YBG201	YBG205				
16	0.50 - 1.50	RT16.01W-A60	○	●				RT16.01N-A60	○					
16		LT16.01W-A60	●					LT16.01N-A60	●					
16	0.50 - 3.00	RT16.01W-AG60	○	●				RT16.01N-AG60	○					
16		LT16.01W-AG60	●					LT16.01N-AG60	●	●				
16	1.75 - 3.00	RT16.01W-G60	○					RT16.01N-G60	○					
16		LT16.01W-G60	●					LT16.01N-G60	○					
16		LT16.01W-G60P	●					LT16.01N-G60P	○					
16		RT16.01W-G60P*	○	○				RT16.01N-G60P*	○					
22	3.50 - 5.00	LT22.01W-N60P	○					-						
22		RT22.01W-N60P*	●					RT22.01N-N60P*	●					
22		LT22.01W-N60P*						LT22.01N-N60P*	○					

● Ex stock ○ On demand
P*: Inserts with chip-breakers

HC¹ Coated carbide

Tool holders

SWR/L	SNR/L
	
A493-A494	A495-A496

R/LT**N/W	I.C	S	d
16	9.525	3.97	4.4
22	12.7	5.56	5.5

Threading inserts

55° partial profile

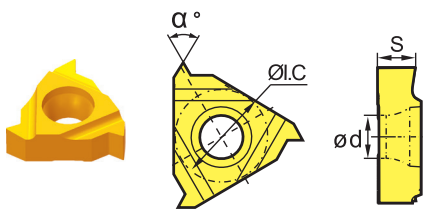

External right hand
Internal left hand

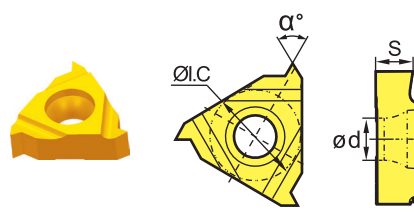

Internal right hand
External left hand

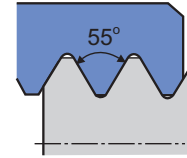



ISO	Pitch (T.Pi)	External	HC ¹ (PVD)					Internal	HC ¹ (PVD)					
			YBG201	YBG205						YBG201	YBG205			
16	48 - 16	RT16.01W-A55	○					RT16.01N-A55	○					
16		LT16.01W-A55	●					LT16.01N-A55	○					
16	48 - 8	RT16.01W-AG55	●					RT16.01N-AG55	○ ●					
16		LT16.01W-AG55	○					LT16.01N-AG55	●					
16	14 - 8	RT16.01W-G55	○					RT16.01N-G55	○					
16		LT16.01W-G55	●					LT16.01N-G55	○					
16		LT16.01W-G55P	●					LT16.01N-G55P	●					
16		RT16.01W-G55P*	○					RT16.01N-G55P*	○					
22	7 - 5	RT22.01W-N55P	○					RT22.01N-N55P	○					
22		-						LT22.01N-N55	○					

● Ex stock ○ On demand
P*: Inserts with chip-breakers

HC¹ Coated carbide

Tool holders

SWR/L	SNR/L
	
A493-A494	A495-A496

System code > A466

Grade selection > A465

Technical info > A501

Cutting data > A500

Threading inserts

R/LT**N/W	I.C	S	d
16	9.525	3.97	4.4

Whitworth

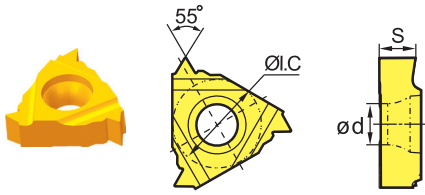

External right hand
Internal left hand

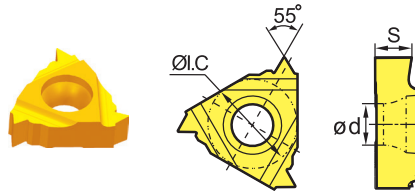

Internal right hand
External left hand

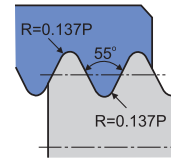

ISO 228-1:1982 DIN 259
B.S.84: 1956 Tolerance: Medium Class 1

ISO	Pitch (T.P.i)	External	HC ¹ (PVD)					Internal	HC ¹ (PVD)					
			YBG201	YBG205					YBG201	YBG205				
16	8.00	RT16.01W-8W	○					RT16.01N-8W	○					
16		LT16.01W-8W	●					LT16.01N-8W	●					
16	9.00	-						RT16.01N-9W	○					
16		LT16.01W-9W	○					LT16.01N-9W	○					
16	10.00	RT16.01W-10W	○					RT16.01N-10W	○					
16		LT16.01W-10W	○					LT16.01N-10W	○					
16	11.00	RT16.01W-11W	○ ●					RT16.01N-11W	○ ●					
16		LT16.01W-11W	●					LT16.01N-11W	○					
16	12.00	RT16.01W-12W	○					RT16.01N-12W	○					
16		LT16.01W-12W	○					LT16.01N-12W	○					
16	14.00	RT16.01W-14W	●					RT16.01N-14W	○ ●					
16		LT16.01W-14W	○					LT16.01N-14W	○					
16	16.00	RT16.01W-16W	○ ●					RT16.01N-16W	○ ●					
16		LT16.01W-16W	○					LT16.01N-16W	○					

● Ex stock ○ On demand

HC¹ Coated carbide

Tool holders

SWR/L	SNR/L
A493-A494	A495-A496

A

Threading inserts

R/LT**N/W	I.C	S	d
16	9.525	3.97	4.4

Turning

UN unified conventional thread 60° full profile

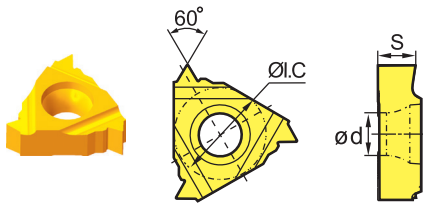

External right hand
Internal left hand

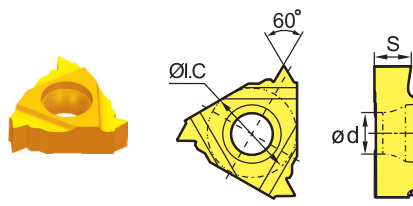

Internal right hand
External left hand

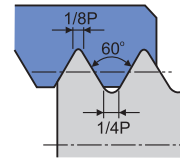

AS/E B1.1-1989
Tolerance: 2A-2B

B

Milling

ISO	Pitch (T.Pi)	External	HC ¹ (PVD)				Internal	HC ¹ (PVD)			
			YBG201	YBG205				YBG201	YBG205		
16	8.00	RT16.01W-8UN	○				RT16.01N-8UN	○			
16		LT16.01W-8UN	○				LT16.01N-8UN	○			
16	10.00	RT16.01W-10UN	○				RT16.01N-10UN	○			
16		LT16.01W-10UN	○				LT16.01N-10UN	○			
16	12.00	RT16.01W-12UN	○				RT16.01N-12UN	○			
16		LT16.01W-12UN	○				LT16.01N-12UN	○			
16	14.00	RT16.01W-14UN	○				RT16.01N-14UN	○			
16		LT16.01W-14UN	○				LT16.01N-14UN	○			
16	16.00	RT16.01W-16UN	○				RT16.01N-16UN	○			
16		LT16.01W-16UN	○				LT16.01N-16UN	○			
16	18.00	RT16.01W-18UN	○				RT16.01N-18UN	○			
16		LT16.01W-18UN	○				LT16.01N-18UN	○			
16	20.00	RT16.01W-20UN	○				RT16.01N-20UN	○			
16		LT16.01W-20UN	○				LT16.01N-20UN	○			
16	24.00	-					RT16.01N-24UN	○			
16		-					LT16.01N-24UN	○			

● Ex stock ○ On demand

HC¹ Coated carbide



C

Drilling

D

Technical Information

Tool holders

SWR/L	SNR/L
	
A493-A494	A495-A496

E

Index

System code > A466

Grade selection > A465

Technical info > A501

Cutting data > A500

Threading inserts

R/LT**N/W	I.C	S	d
16	9.525	3.97	4.4

BSPT Whitworth taper pipe thread

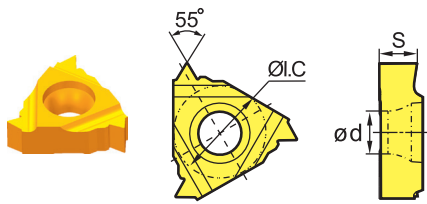

External right hand
Internal left hand

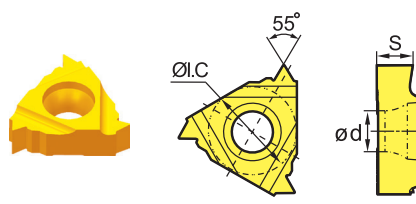

Internal right hand
External left hand

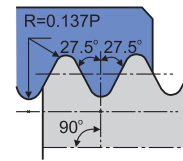



ISO 7-1: 1984 B.S.21:1985
Standard BSPT

ISO	Pitch (T.P.i)	External	HC ¹ (PVD)				Internal	HC ¹ (PVD)			
			YBG201	YBG205				YBG201	YBG205		
16	11.00	RT16.01W-11BSPT	○				RT16.01N-11BSPT	○			
16		LT16.01W-11BSPT	●				LT16.01N-11BSPT	○			
16	14.00	RT16.01W-14BSPT	○				RT16.01N-14BSPT	○			
16		LT16.01W-14BSPT	○				LT16.01N-14BSPT	○			
16	19.00	RT16.01W-19BSPT	○				RT16.01N-19BSPT	○			
16		LT16.01W-19BSPT	○				LT16.01N-19BSPT	○			
16	28.00	RT16.01W-28BSPT	○				RT16.01N-28BSPT	○			
16		LT16.01W-28BSPT	○				LT16.01N-28BSPT	○			

● Ex stock ○ On demand

HC¹ Coated carbide

Tool holders

SWR/L	SNR/L
	
A493-A494	A495-A496

A

Threading inserts

R/LT**N/W	I.C	S	d
16	9.525	3.97	4.4

Turning

NPT American taper pipe thread

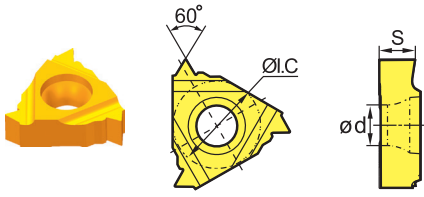

External right hand
Internal left hand

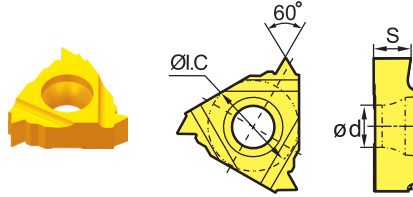

Internal right hand
External left hand

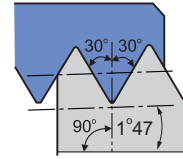

ASME B1.20.1-1983
Standard NPT

B

Milling

ISO	Pitch (T.P.i)	External	HC ¹ (PVD)				Internal	HC ¹ (PVD)			
			YBG201	YBG205				YBG201	YBG205		
16	8.00	RT16.01W-8NPT	○				RT16.01N-8NPT	○			
16		LT16.01W-8NPT	○				LT16.01N-8NPT	○			
16	11.50	RT16.01W-11.5NPT	○				RT16.01N-11.5NPT	○			
16		LT16.01W-11.5NPT	○				LT16.01N-11.5NPT	○			
16	14.00	RT16.01W-14NPT	○ ○				RT16.01N-14NPT	○			
16		LT16.01W-14NPT	○				LT16.01N-14NPT	○			
16	18.00	RT16.01W-18NPT	○				RT16.01N-18NPT	○			
16		LT16.01W-18NPT	○				LT16.01N-18NPT	○			
16	27.00	RT16.01W-27NPT	○				RT16.01N-27NPT	○			
16		LT16.01W-27NPT	○				LT16.01N-27NPT	○			

● Ex stock ○ On demand

HC¹ Coated carbide



C

Drilling

D

Technical Information

Tool holders

SWR/L	SNR/L
	
A493-A494	A495-A496

E

Index

System code > A466

Grade selection > A465

Technical info > A501

Cutting data > A500

Threading inserts

R/LT**N/W	I.C	S	d
16	9.525	3.97	4.4

NPTF dryseal American taper pipe thread 60°

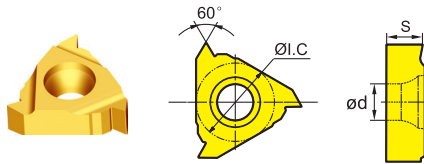

External right hand
Internal left hand

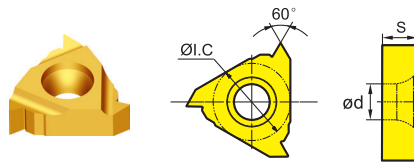

Internal right hand
External left hand

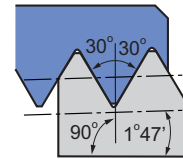



ASME B1.20.1-1983
Tolerance: 2

ISO	Pitch (T.P.i)	External	HC ¹ (PVD)					Internal	HC ¹ (PVD)					
			YBG201	YBG205					YBG201	YBG205				
16	8.00	-							○					
16	11.50	RT16.01W-11.5NPTF	○						○					
16	14.00	RT16.01W-14NPTF	○						○					
16	18.00	RT16.01W-18NPTF	○						○					
16	27.00	-							○					

● Ex stock ○ On demand

HC¹ Coated carbide

Tool holders

SWR/L	SNR/L
	
A493	A495

System code > A466

Grade selection > A465

Technical info > A501

Cutting data > A500

A

Threading inserts

R/LT**N/W	I.C	S	d
16	9.525	3.97	4.4

Turning

R knuckle thread 30°

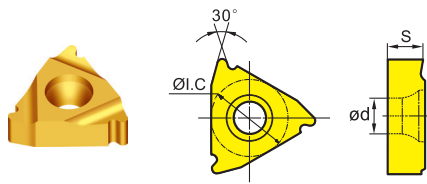

External right hand
Internal left hand

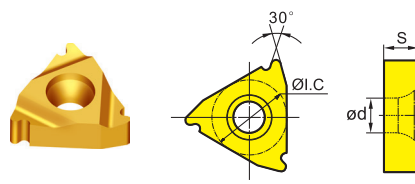

Internal right hand
External left hand

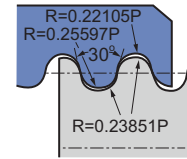

DIN 405
Tolerance: 7

B

Milling

ISO	Pitch (T.P.i)	External	HC ¹ (PVD)				Internal	HC ¹ (PVD)			
			YBG201	YBG205				YBG201	YBG205		
16	6.00	RT16.01W-6R	○				RT16.01N-6R	○	○		
16	8.00	RT16.01W-8R	○				RT16.01N-8R	○	○		
16	10.00	RT16.01W-10R	○				RT16.01N-10R	○	○		

● Ex stock ○ On demand

HC¹ Coated carbide

C

Drilling

Tool holders

SWR/L	SNR/L
A493	A495

D

Technical Information

E

Index

System code > A466

Grade selection > A465

Technical info > A501

Cutting data > A500

Threading inserts

R/LT**N/W	I.C	S	d
16	9.525	3.97	4.4

MJ thread for aerospace

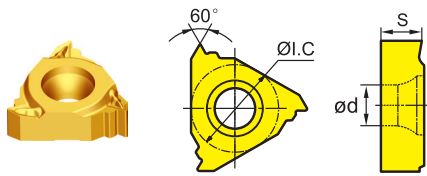

External right hand
Internal left hand

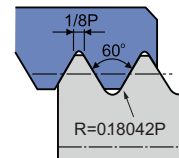

ISO 5855-1999
Tolerance: 4

ISO	Pitch (mm)	External	HC ¹ (PVD)					Internal	HC ¹ (PVD)					
			YBG201	YBG205					YBG201	YBG205				
16	1.50	RT16.01W-1.50MJ	○					-						
16	2.00	RT16.01W-2.00MJ	○					-						

● Ex stock ○ On demand

HC¹ Coated carbide

Tool holders

SWR/L



A493

A

Turning

B

Milling

C

Drilling

D

Technical Information

E

Index

A

Threading inserts

R/LT**N/W	I.C	S	d
16	9.525	3.97	4.4

Turning

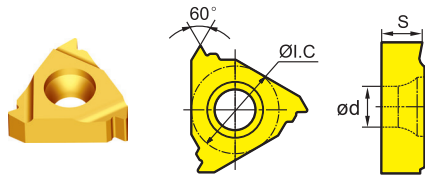

External right hand
Internal left hand

UNJ unified screw thread

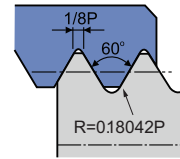

ISO 3161-1999
Tolerance: 3A

B

Milling

ISO	Pitch (T.P.i)	External	HC ¹ (PVD)					Internal	HC ¹ (PVD)					
			YBG201	YBG205						YBG201	YBG205			
16	10.00	RT16.01W-10UNJ	○					-						
16	12.00	RT16.01W-12UNJ	○					-						
16	14.00	RT16.01W-14UNJ	○					-						
16	18.00	RT16.01W-18UNJ	○					-						
16	20.00	RT16.01W-20UNJ	○					-						
16	24.00	RT16.01W-24UNJ	○					-						
16	28.00	RT16.01W-28UNJ	○					-						
16	32.00	RT16.01W-32UNJ	○					-						

● Ex stock ○ On demand

HC¹ Coated carbide

C

Drilling

Tool holders

SWR/L



A493

D

Technical Information

E

Index

System code > A466

Grade selection > A465

Technical info > A501

Cutting data > A500

Threading inserts

R/LT**N/W	I.C	S	d
16	9.525	3.97	4.4

TR metrical ISO trapezoidal thread 30°

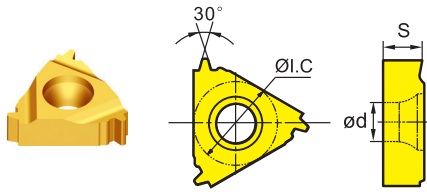

External right hand
Internal left hand

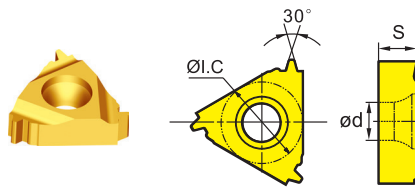

Internal right hand
External left hand

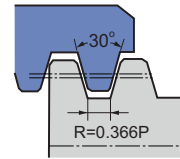



ISO 2901-2904
Tolerance: 7

ISO	Pitch (mm)	External	HC ¹ (PVD)					Internal	HC ¹ (PVD)					
			YBG201	YBG205					YBG201	YBG205				
16	1.50	RT16.01W-1.50TR	○					●						
16	2.00	RT16.01W-2.00TR	○ ○					○ ○						
16	3.00	RT16.01W-3.00TR	○ ○					○ ●						

● Ex stock ○ On demand

HC¹ Coated carbide

Tool holders

SWR/L	SNR/L
	
A493	A495

A

Turning

B

Milling

C

Drilling

D

Technical Information

E

Index

R/LT**N/W	I.C	S	d
16	9.525	3.97	4.4

Threading inserts

ACME American national thread 29°

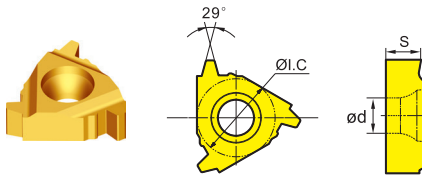

External right hand
Internal left hand

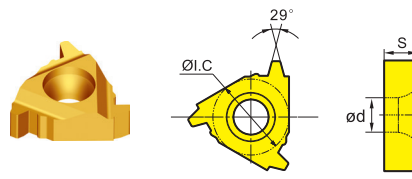

Internal right hand
External left hand

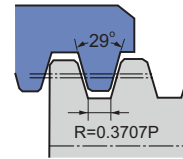



ANSI B1.5-1988
Tolerance: 2G

ISO	Pitch (T.P.i)	External	HC ¹ (PVD)				Internal	HC ¹ (PVD)			
			YBG201	YBG205				YBG201	YBG205		
16	8.00	RT16.01W-8AC	○				RT16.01N-8AC	○			
16	10.00	RT16.01W-10AC	○				RT16.01N-10AC	○			
16	12.00	RT16.01W-12AC	○				RT16.01N-12AC	○			
16	14.00	RT16.01W-14AC	○				RT16.01N-14AC	○			
16	16.00	RT16.01W-16AC	○				RT16.01N-16AC	○			

● Ex stock ○ On demand

HC¹ Coated carbide

Tool holders

SWR/L	SNR/L
	
A493	A495

A

Turning

B

Milling

C

Drilling

D

Technical Information

E

Index

System code > A466

Grade selection > A465

Technical info > A501

Cutting data > A500

Threading inserts

R/LT**N/W	I.C	S	d
16	9.525	3.97	4.4

STUB-ACME thread

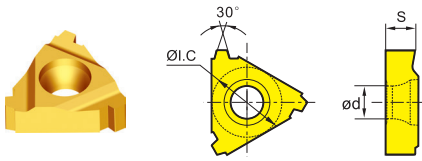

External right hand
Internal left hand

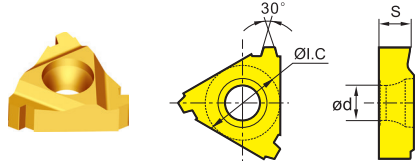

Internal right hand
External left hand

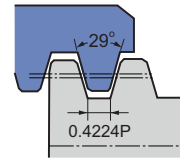



ANSI B1.8-1988
Tolerance: API Standard

ISO	Pitch (T.P.i)	External	HC ¹ (PVD)				Internal	HC ¹ (PVD)			
			YBG201	YBG205				YBG201	YBG205		
16	8.00	RT16.01W-8STAC	○				RT16.01N-8STAC	○			
16	10.00	RT16.01W-10STAC	○				RT16.01N-10STAC	○			
16	12.00	RT16.01W-12STAC	○				RT16.01N-12STAC	○			
16	14.00	RT16.01W-14STAC	○				RT16.01N-14STAC	○			
16	16.00	RT16.01W-16STAC	○				RT16.01N-16STAC	○			

● Ex stock ○ On demand

HC¹ Coated carbide

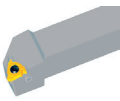
Tool holders

SWR/L	SNR/L
	
A493	A495

A

Turning

B

Milling

C

Drilling

D

Technical Information

E

Index

A

Threading inserts

R/LT**N/W	I.C	S	d
22	12.7	5.56	5.5

Turning

API 60° thread

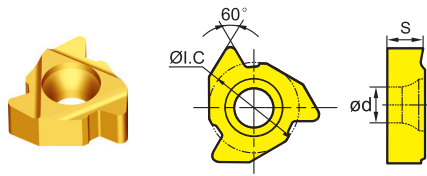

External right hand
Internal left hand

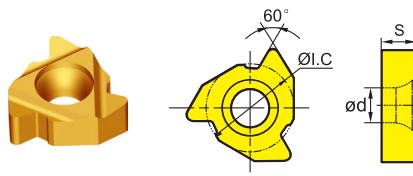

Internal right hand
External left hand

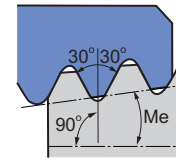

Me = taper, 2i.p.f-4°46', 3i.p.f-7°01'
API SPEC7:1990 Tolerance: API Standard

B

Milling



ISO	Pitch (T.P.i)	External	HC ¹ (PVD)				Internal	HC ¹ (PVD)			
			YBG201	YBG205				YBG201	YBG205		
22	4.00	RT22.01W-4AP382	○				RT22.01N-4AP382	○			
22		RT22.01W-4AP383	○				RT22.01N-4AP383	○			
22		RT22.01W-4AP502	○				RT22.01N-4AP502	○			
22		RT22.01W-4AP503	○				RT22.01N-4AP503	○			
22	5.00	RT22.01W-5AP403	○				RT22.01N-5AP403	○			

● Ex stock ○ On demand

HC¹ Coated carbide

C

Drilling

Tool holders	
SWR/L	SNR/L
	
A493	A495

D

Technical Information

E

Index

System code > A466

Grade selection > A465

Technical info > A501

Cutting data > A500

Threading inserts

R/LT**N/W	I.C	S	d
16	9.525	3.97	4.4
22	12.7	5.56	5.5

API round thread

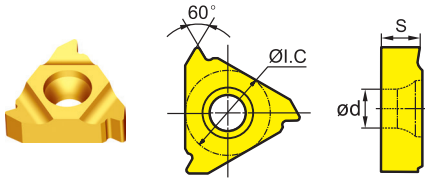

External right hand
Internal left hand

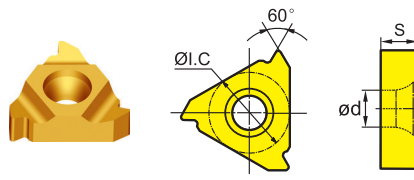

Internal right hand
External left hand

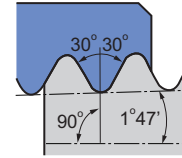



API spec.5B
Tolerance: API RD

ISO	Pitch (T.P.i)	External	HC ¹ (PVD)				Internal	HC ¹ (PVD)			
			YBG201	YBG205				YBG201	YBG205		
16	8.00	RT16.01W-8RD	○				RT16.01N-8RD	○			
16	10.00	RT16.01W-10RD	○				RT16.01N-10RD	○			
22	8.00	RT22.01W-8RD	○				RT22.01N-8RD	○			
22	10.00	RT22.01W-10RD	○				RT22.01N-10RD	○			

● Ex stock ○ On demand

HC¹ Coated carbide

Tool holders

SWR/L	SNR/L
	
A493	A495

System code > A466

Grade selection > A465

Technical info > A501

Cutting data > A500

A

Threading inserts

R/LT**N/W	I.C	S	d
22	12.7	5.56	5.5

Turning

API American buttress thread

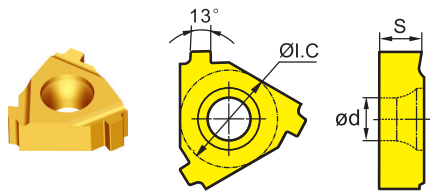

External right hand
Internal left hand

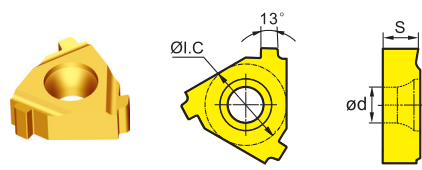

Internal right hand
External left hand

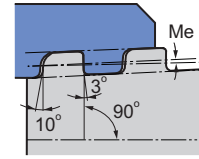

Me=taper 3/4i.p.f-1°47'-1°47' for Ø 4 1/2-13 3/8"
1 i.p.f--2°23' for Ø16" SEPC.5B.1979 Tol.: API Std.

B

Milling

ISO	Pitch (T.P.i)	External	HC ¹ (PVD)				Internal	HC ¹ (PVD)			
			YBG201	YBG205				YBG201	YBG205		
22	5.00	RT22.01W-5BUT	○				RT22.01N-5BUT	○			



● Ex stock ○ On demand

HC¹ Coated carbide

C

Drilling

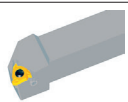
Tool holders

SWR/L	SNR/L
	
A493	A495

D

Technical Information

E

Index

System code > A466

Grade selection > A465

Technical info > A501

Cutting data > A500

Threading inserts (thin type)

R/LT**N/W	I.C	S	d
16	9.525	3.52	4

ISO metric coarse thread 60° full profile (thin type)

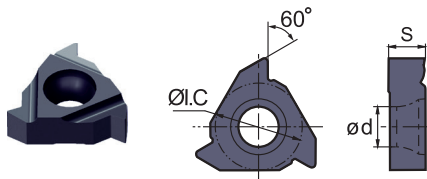

External right hand
Internal left hand

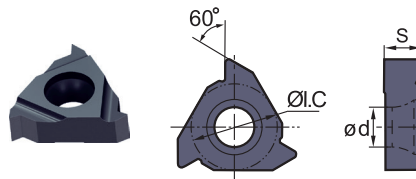

Internal right hand
External left hand

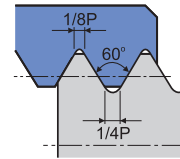



ISO 965-1980 DIN 13
GB-T 197-2003 Tolerance: 6g/6H

ISO	Pitch (mm)	External	HC ¹ (PVD)					Internal	HC ¹ (PVD)					
			YBG202	YBG205					YBG202	YBG205				
16	0.50	RT16.01W-0.50GMB	○	○				RT16.01N-0.50GMB	○	○				
16	0.75	RT16.01W-0.75GMB	○	○				RT16.01N-0.75GMB	○	○				
16	1.00	RT16.01W-1.00GMB	○	○				RT16.01N-1.00GMB	○	○				
16		-						RT16.01N-1.00GMPB	○					
16	1.25	RT16.01W-1.25GMB	○	○				RT16.01N-1.25GMB	○	○				
16	1.50	RT16.01W-1.50GMB	○	○				RT16.01N-1.50GMB	○					
16		RT16.01W-1.50GMPB*	○	○				-						
16	1.75	RT16.01W-1.75GMB	○	○				RT16.01N-1.75GMB	○	○				
16	2.00	RT16.01W-2.00GMB	○	○				RT16.01N-2.00GMB	○	○				
16		-						RT16.01N-2.00GMPB*	○	○				
16	2.50	RT16.01W-2.50GMB	○	○				RT16.01N-2.50GMB	○	○				
16	3.00	RT16.01W-3.00GMB	○	○				RT16.01N-3.00GMB	○	○				
16		-						RT16.01N-3.00GMPB*	○					

● Ex stock ○ On demand
PB*: Inserts with chip-breakers

HC¹ Coated carbide

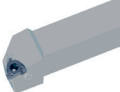
Tool holders

SWR	SNR
	
A497	A498

System code > A466

Grade selection > A465

Technical info > A501

Cutting data > A500



A

Threading inserts (thin type)

R/LT**N/W	I.C	S	d
16	9.525	3.52	4

Turning

60° partial profile (thin type)

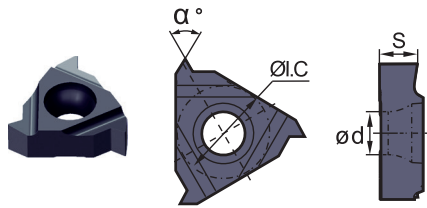

External right hand
Internal left hand

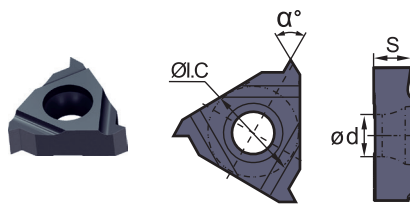

Internal right hand
External left hand

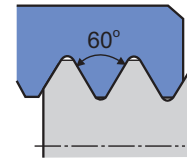

B

Milling

ISO	Pitch (mm)	External	HC ¹ (PVD)				Internal	HC ¹ (PVD)			
			YBG202	YBG205				YBG202	YBG205		
16	0.50 - 1.50	RT16.01W-A60B	○				RT16.01N-A60B	○			
16	0.50 - 3.00	RT16.01W-AG60B	○				RT16.01N-AG60B	○			
16		RT16.01W-AG60PB*	○				-				
16	1.75 - 3.00	RT16.01W-G60B	○				RT16.01N-G60B	○			



● Ex stock ○ On demand
PB*: Inserts with chip-breakers

HC¹ Coated carbide

C

Drilling

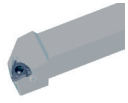
Tool holders

SWR	SNR
	
A497	A498

D

Technical Information

E

Index

System code > A466

Grade selection > A465

Technical info > A501

Cutting data > A500

Threading inserts (thin type)

R/LT**N/W	I.C	S	d
16	9.525	3.52	4

55° partial profile (thin type)

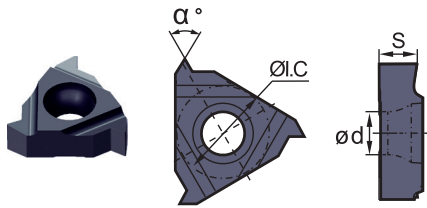

External right hand
Internal left hand

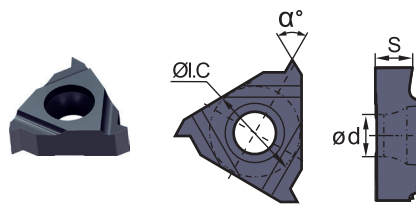

Internal right hand
External left hand

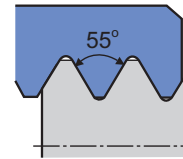



ISO	Pitch (T.P.i)	External	HC ¹ (PVD)					Internal	HC ¹ (PVD)					
			YBG202	YBG205					YBG202	YBG205				
16	48 - 16	RT16.01W-A55B	○					RT16.01N-A55B	○					
16	48 - 8	RT16.01W-AG55B	○					RT16.01N-AG55B	○					
16		RT16.01W-AG55PB	○	○				-						
16	14 - 8	RT16.01W-G55B	○					RT16.01N-G55B	○					

● Ex stock ○ On demand
PB*: Inserts with chip-breakers

HC¹ Coated carbide

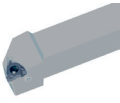
Tool holders

SWR	SNR
	
A497	A498

System code > A466

Grade selection > A465

Technical info > A501

Cutting data > A500

A

Turning

B

Milling

C

Drilling

D

Technical Information

E

Index

A

Threading inserts (thin type)

R/LT**N/W	I.C	S	d
16	9.525	3.52	4

Turning

Whitworth (thin type)

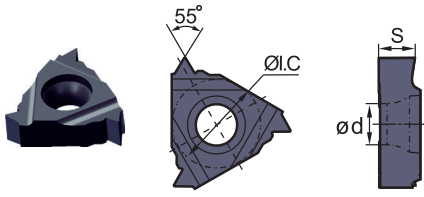

External right hand
Internal left hand

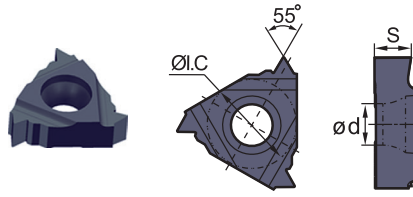

Internal right hand
External left hand

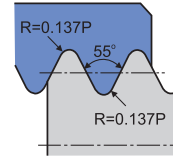

ISO 965-1980 DIN 13
GB-T 197-2003 Tolerance: Medium Class A

B

Milling

ISO	Pitch (T.Pi)	External	HC ¹ (PVD)					Internal	HC ¹ (PVD)					
			YBG202	YBG205					YBG202	YBG205				
16	8.00	RT16.01W-8WB	○					RT16.01N-8WB	○					
16	9.00	RT16.01W-9WB	○					RT16.01N-9WB	○					
16	10.00	RT16.01W-10WB	○					RT16.01N-10WB	○					
16	11.00	RT16.01W-11WB	○	○				RT16.01N-11WB	○					
16		-						RT16.01N-11WPB	○					
16	12.00	RT16.01W-12WB	○					RT16.01N-12WB	○					
16		RT16.01W-14WB	○					RT16.01N-14WB	○					
16	14.00	-						RT16.01N-14WPB*	○					
16		RT16.01W-16WB	○					RT16.01N-16WB	○	○				

C

Drilling



● Ex stock ○ On demand
PB*: Inserts with chip-breakers

HC¹ Coated carbide

D

Technical Information

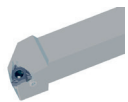
Tool holders

SWR	SNR
	
A497	A498

E

Index

System code > A466

Grade selection > A465

Technical info > A501

Cutting data > A500

Threading inserts (thin type)

R/LT**N/W	I.C	S	d
16	9.525	3.52	4

UN unified conventional thread 60° full profile (thin type)

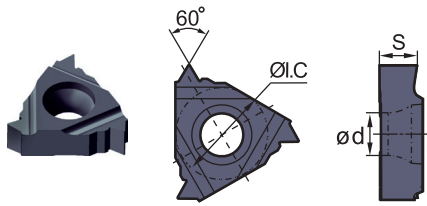

External right hand
Internal left hand

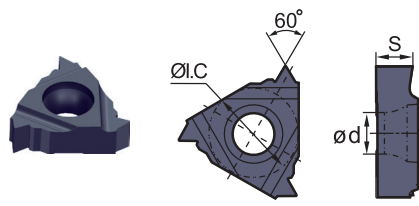

Internal right hand
External left hand

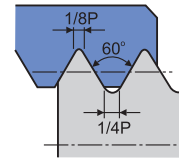



ASME B1.1-1989
Tolerance: 2A/2B

ISO	Pitch (T.P.i)	External	HC ¹ (PVD)				Internal	HC ¹ (PVD)			
			YBG202	YBG205				YBG202	YBG205		
16	8.00	RT16.01W-8UNB	○				RT16.01N-8UNB	○			
16	10.00	RT16.01W-10UNB	○				RT16.01N-10UNB	○			
16	12.00	RT16.01W-12UNB	○				RT16.01N-12UNB	○			
16	14.00	RT16.01W-14UNB	○				RT16.01N-14UNB	○			
16	16.00	RT16.01W-16UNB	○				RT16.01N-16UNB	○			
16	18.00	RT16.01W-18UNB	○				RT16.01N-18UNB	○			
16	20.00	RT16.01W-20UNB	○				RT16.01N-20UNB	○			
16	24.00	-					RT16.01N-24UNB	○			

● Ex stock ○ On demand

HC¹ Coated carbide

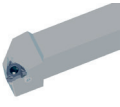
Tool holders

SWR	SNR
	
A497	A498

A

Threading inserts (thin type)

R/LT**N/W	I.C	S	d
16	9.525	3.52	4

Turning

BSPT Whitworth taper pipe thread (thin type)

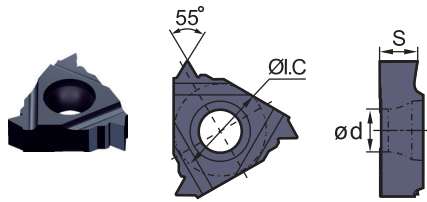

External right hand
Internal left hand

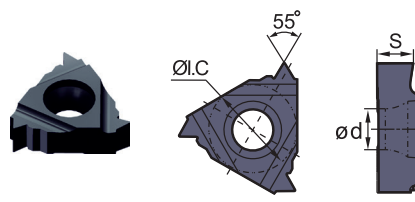

Internal right hand
External left hand

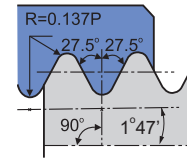

ASME B1.1-1989
Standard BSPT

B

Milling

ISO	Pitch (T.Pi)	External	HC ¹ (PVD)				Internal	HC ¹ (PVD)			
			YBG202	YBG205				YBG202	YBG205		
16	11.00	RT16.01W-11BSPTB	○	○			RT16.01N-11BSPTB	○	○		
16	14.00	RT16.01W-14BSPTB	○				RT16.01N-14BSPTB	○			
16		RT16.01W-14BSPTPB*	○				RT16.01N-14BSPTPB*	○	○		
16	19.00	RT16.01W-19BSPTB	○				RT16.01N-19BSPTB	○			
16	28.00	RT16.01W-28BSPTB	○				RT16.01N-28BSPTB	○			

● Ex stock ○ On demand
PB*: Inserts with chip-breakers

HC¹ Coated carbide

C

Drilling

Tool holders	
SWR	SNR
A497	A498

D

Technical Information

E

Index

System code > A466

Grade selection > A465

Technical info > A501

Cutting data > A500

Threading inserts (thin type)

R/LT**N/W	I.C	S	d
16	9.525	3.52	4

NPT American taper pipe thread (thin type)

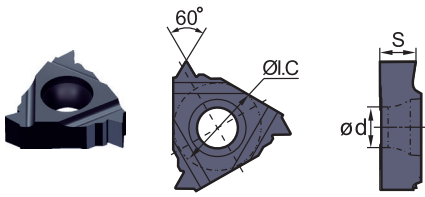

External right hand
Internal left hand

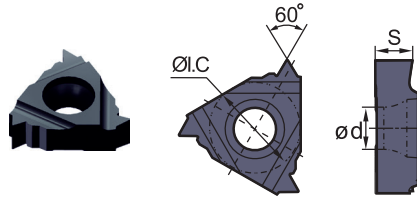

Internal right hand
External left hand

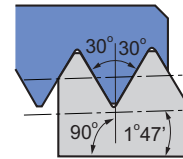



ASME B1.20.1-1983
Standard NPT

ISO	Pitch (T.P.i)	External	HC ¹ (PVD)					Internal	HC ¹ (PVD)					
			YBG202	YBG205					YBG202	YBG205				
16	8.00	RT16.01W-8NPTB	○					RT16.01N-8NPTB	○					
16	11.50	RT16.01W-11.5NPTB	○					RT16.01N-11.5NPTB	○					
16		-						RT16.01N-11.5NPTPB*	○					
16	14.00	RT16.01W-14NPTB	○	○				RT16.01N-14NPTB	○					
16		-						RT16.01N-14NPTPB*	○	○				
16	18.00	RT16.01W-18NPTB	○					RT16.01N-18NPTB	○					
16	27.00	RT16.01W-27NPTB	○					RT16.01N-27NPTB	○					

● Ex stock ○ On demand
PB*: Inserts with chip-breakers

HC¹ Coated carbide

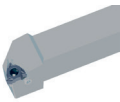
Tool holders



SWR	SNR
	
A497	A498

S W R 20 20 K 16 (B)

1 2 3 4 5 6 7 8

A

Turning

Clamping system	
Code	Description
S	Screw clamping 
C	Top clamping 

Application	
Code	Description
W	External thread tool holder
N	Internal thread tool holder

B

Milling

1

2

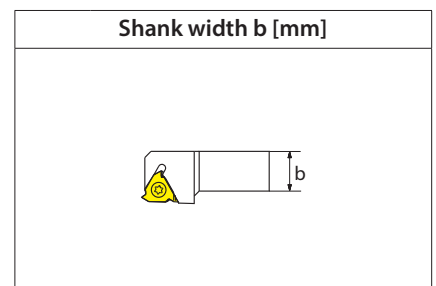
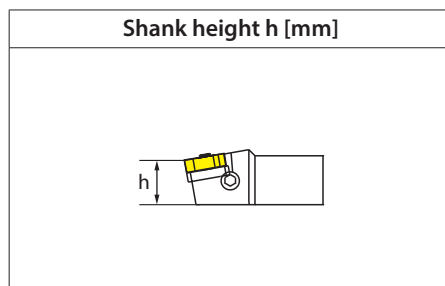
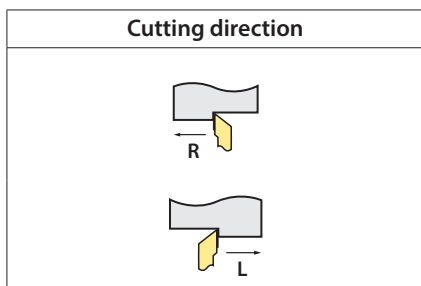

3

4

5

C

Drilling

Shank length L [mm]	
Code	L
H	100
K	125
M	150
P	170
Q	180
R	200
S	250
T	300

Insert size [mm]	
Code	Height
11	6,35
16	9,525
22	12,7

6

7

D

Technical Information

Holder for thin thread inserts
(B type)

8

E

Index

Threading tool holder (external)

SWR/L

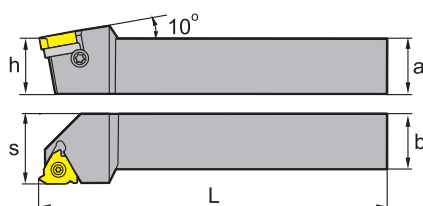
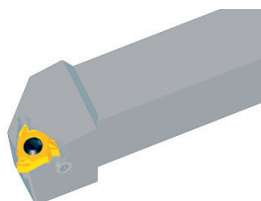

Article	*	Stock	Dimensions [mm]					Inserts
			a	b	L	h	s	
SWR1616H16		●	16	16	100	16	20	RT16.01W-****
SWR2020K16		●	20	20	125	20	25	RT16.01W-****
SWR2525M16		●	25	25	150	25	32	RT16.01W-****
SWR3225P16		●	32	25	170	32	32	RT16.01W-****
SWR3232P16		●	32	32	170	32	40	RT16.01W-****
SWR2525M22		●	25	25	150	25	32	RT22.01W-****
SWR3225P22		●	32	25	170	32	32	RT22.01W-****
SWR3232P22		●	32	32	170	32	40	RT22.01W-****
SWR4040S22		○	40	40	250	40	50	RT22.01W-****

● Ex stock ○ On demand

* With internal cooling

Spare parts			
	Insert	RT16.01W-****	RT22.01W-****
	h	16-32	25-40
	Screw	I60M3.5x12 (2.7 Nm)	I60M5x17 (6.7 Nm)
	Screw (shim)	SM4x8C	SM5x8.5C
	Shim	MT16-__M	MT22-__M
	Wrench (screw)	WT15IP	WT20IP

Insert



Medium Cut
A467

System code > A492

Grade selection > A465

Technical info > A501

Cutting data > A500



A

Turning

B

Milling

C

Drilling

D

Technical Information

E

Index

Threading tool holder (external)

SWR/L

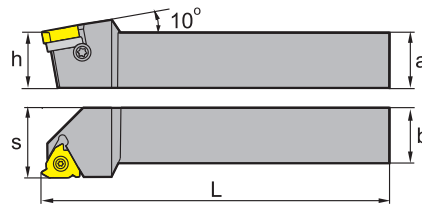
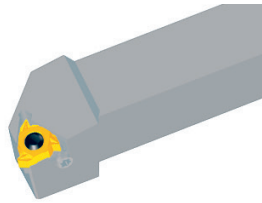

Article	*	Stock	Dimensions [mm]					Inserts
			a	b	L	h	s	
SWL1616H16		●	16	16	100	16	20	LT16.01W-****
SWL2020K16		●	20	20	125	20	25	LT16.01W-****
SWL2525M16		●	25	25	150	25	32	LT16.01W-****
SWL3225P16		●	32	25	170	32	32	LT16.01W-****
SWL3232P16		○	32	32	170	32	40	LT16.01W-****
SWL2525M22		●	25	25	150	25	32	LT22.01W-****
SWL3225P22		○	32	25	170	32	32	LT22.01W-****
SWL3232P22		●	32	32	170	32	40	LT22.01W-****
SWL4040S22		○	40	40	250	40	50	LT22.01W-****

● Ex stock ○ On demand

* With internal cooling

Spare parts			
	Insert	LT16.01W-****	LT22.01W-****
	h	16-32	25-40
	Screw	I60M3.5×12 (2.7 Nm)	I60M5×17 (6.7 Nm)
	Screw (shim)	SM4×8C	SM5×8.5C
	Shim	MT16-__M	MT22-__M
	Wrench (screw)	WT15IP	WT20IP

Insert
Medium Cut
A467

System code > A492

Grade selection > A465

Technical info > A501

Cutting data > A500

Threading tool holder (internal)

SNR/L

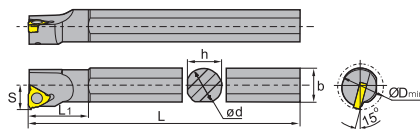
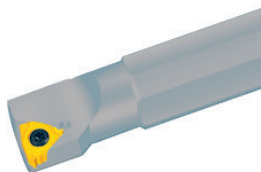

Article	*	Stock	Dimensions [mm]							Inserts
			ød	b	L	h	s	L ₁	D _{min}	
SNR0016K11	●	●	16	16	125	15	10	20.9	12	RT11.01N-****
SNR0016M11	●	●	16	15.5	150	15	10.5	25.9	16	RT11.01N-****
SNR0016M16	●	●	16	15.5	150	15	12	27	20	RT16.01N-****
SNR0020M16	●	●	20	19	150	18	14	28.7	25	RT16.01N-****
SNR0020Q16	●	●	20	19	180	18	14	34	25	RT16.01N-****
SNR0025M16	●	●	25	24	150	23	17	28.8	32	RT16.01N-****
SNR0032R16	●	●	32	31	200	30	22	30.9	40	RT16.01N-****
SNR0032S16	●	●	32	31	250	30	22	30.9	40	RT16.01N-****
SNR0040T16	●	●	40	38.5	300	37	27	31.5	50	RT16.01N-****
SNR0050U16	○	○	50	49.5	350	49	35	40.2	63	RT16.01N-****
SNR0020Q22	●	●	20	21.5	180	18	15	35	25	RT22.01N-****
SNR0025R22	●	●	25	24	200	23	19	39	32	RT22.01N-****
SNR0032S22	●	●	32	31	250	30	22	36.4	40	RT22.01N-****
SNR0040T22	●	●	40	38.5	300	37	27	37.2	50	RT22.01N-****
SNR0050U22	●	●	50	48.5	350	47	35	42.6	63	RT22.01N-****

● Ex stock ○ On demand

* With internal cooling

Spare parts						
	Insert	RT11.01N-****	RT16.01N-****	RT16.01N-****	RT22.01N-****	RT22.01N-****
	ød	16	16	20-50	20	25-50
	Screw	I60M2.5x6.5 (1.0 Nm)	I60M3.5x8 (2.7 Nm)	I60M3.5x12 (2.7 Nm)	I60M5x10 (6.7 Nm)	I60M5x17 (6.7 Nm)
	Screw (shim)			SM4x8C		SM5x8.5C
	Shim			MT16-__M		MT22-__M
	Wrench (screw)	WT07IP	WT15IP	WT15IP	WT20IP	WT20IP

Insert



Medium Cut

A467

System code > A492

Grade selection > A465

Technical info > A501

Cutting data > A500



Threading tool holder (internal)

SNR/L

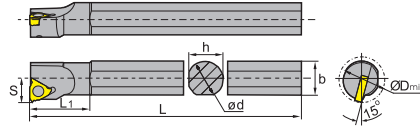

Article	*	Stock	Dimensions [mm]								Inserts
			ød	b	L	h	s	L ₁	D _{min}		
SNL0016K11	●	●	16	16	125	15	10	20.9	12	LT11.01N-****	
SNL0016M11	●	●	16	15.5	150	15	10.5	25.9	16	LT11.01N-****	
SNL0016M16	●	●	16	15.5	150	15	12	27	20	LT16.01N-****	
SNL0020M16	○	○	20	19	150	18	14	28.7	25	LT16.01N-****	
SNL0020Q16	●	●	20	19	180	18	14	34	25	LT16.01N-****	
SNL0025M16	●	●	25	24	150	23	17	28.8	32	LT16.01N-****	
SNL0032R16	●	●	32	31	200	30	22	30.9	40	LT16.01N-****	
SNL0032S16	○	○	32	31	250	30	22	30.9	40	LT16.01N-****	
SNL0040T16	●	●	40	38.5	300	37	27	31.5	50	LT16.01N-****	
SNL0050U16	○	○	50	49.5	350	49	35	40.2	63	LT16.01N-****	
SNL0020Q22	●	●	20	21.5	180	18	15	35	25	LT22.01N-****	
SNL0025R22	○	○	25	24	200	23	19	39	32	LT22.01N-****	
SNL0032S22	●	●	32	31	250	30	22	36.4	40	LT22.01N-****	
SNL0040T22	●	●	40	38.5	300	37	27	37.2	50	LT22.01N-****	
SNL0050U22	●	●	50	48.5	350	47	35	42.6	63	LT22.01N-****	

● Ex stock ○ On demand

* With internal cooling

Spare parts						
	Insert	LT11.01N-****	LT16.01N-****	LT16.01N-****	LT22.01N-****	LT22.01N-****
	ød	16	16	20-50	20	25-50
	Screw	I60M2.5×6.5 (1.0 Nm)	I60M3.5×8 (2.7 Nm)	I60M3.5×12 (2.7 Nm)	I60M5×10 (6.7 Nm)	I60M5×17 (6.7 Nm)
	Screw (shim)			SM4×8C		SM5×8.5C
	Shim			MT16-__M		MT16-__M
	Wrench (screw)	WT07IP	WT15IP	WT15IP	WT20IP	WT20IP

Insert



Medium Cut
A467

System code > A492

Grade selection > A465

Technical info > A501

Cutting data > A500

Threading tool holder (external)

SWR-B Thin Type

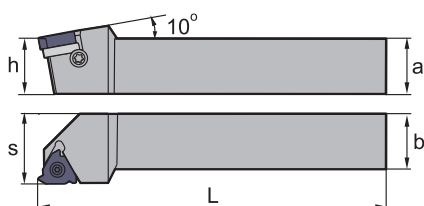
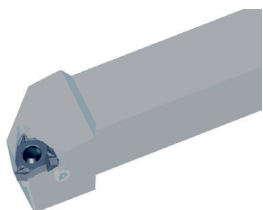

Article	*	Stock	Dimensions [mm]					Inserts
			a	b	L	h	s	
SWR1616H16B		●	16	16	100	16	20	RT16.01W-****B
SWR2020K16B		●	20	20	125	20	25	RT16.01W-****B
SWR2525M16B		●	25	25	150	25	32	RT16.01W-****B
SWR3225P16B		●	32	25	170	32	32	RT16.01W-****B
SWR3232P16B		●	32	32	170	32	40	RT16.01W-****B

● Ex stock ○ On demand

* With internal cooling

Spare parts		
	Insert	RT16.01W-****B
	h	16-32
	Screw	I60M3.5x12TT (2.7 Nm)
	Screw (shim)	SM4x8C
	Shim	MT16-__M
	Wrench (screw)	WT15IP

Insert
Medium Cut
A486

System code > A492

Grade selection > A465

Technical info > A501

Cutting data > A500

Threading tool holder (internal)

SNR-B Thin Type

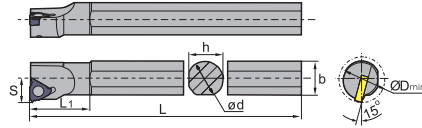
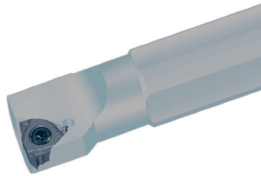

Article	*	Stock	Dimensions [mm]							Inserts
			ød	b	L	h	s	L ₁	D _{min}	
SNR0016M16B	●		16	15.5	150	15	12	27	20	RT16.01N-****B
SNR0020Q16B	●		20	19	180	18	14	34	25	RT16.01N-****B
SNR0025M16B	●		25	24	150	23	17	28.8	32	RT16.01N-****B
SNR0032R16B	●		32	31	200	30	22	30.9	40	RT16.01N-****B
SNR0032S16B	●		32	31	250	30	22	30.9	40	RT16.01N-****B

● Ex stock ○ On demand

* With internal cooling

Spare parts			
	Insert	RT16.01N-****B	RT16.01N-****B
	ød	16	20-32
	Screw	I60M3.5×08TT (2.7 Nm)	
	Screw		I60M3.5×12TT (2.7 Nm)
	Screw (shim)		SM4×8C
	Shim		MT16-__M
	Wrench (screw)	WT15IP	WT15IP

System code > A492

Grade selection > A465

Technical info > A501

Cutting data > A500

Threading inserts

Material group	Composition / structure / heat treatment		Brinell hardness HB	Machining group	Starting values for cutting speed v_c [m/min]			
					HC (PVD)			
					YBG201	YBG205		
P Unalloyed steel Low-alloyed steel High-alloyed steel and high-alloyed tool steel	approx. 0,15 % C	annealed	125	1	190	190		
		approx. 0,45 % C	annealed	190	2	175	175	
		approx. 0,45 % C	tempered	250	3	145	145	
		approx. 0,75 % C	annealed	270	4	140	140	
	approx. 0,75 % C	tempered	300	5	135	135		
		annealed	180	6	170	170		
		tempered	275	7	125	125		
	High-alloyed steel and high-alloyed tool steel	tempered	300	8	115	115		
		tempered	350	9	105	105		
	M Stainless steel	ferritic/martensitic	annealed	200	12	165	165	
martensitic		tempered	240	13	135	135		
austenitic		quench hardened	180	14	155	155		
austenitic-ferritic			230	15	135	135		
perlitic/ferritic			180	16	240	240		
K Grey cast iron Cast iron with spheroidal graphite Malleable cast iron	perlitic (martensitic)		260	17	185	185		
	ferritic		160	18	220	220		
	perlitic		250	19	165	165		
	ferritic		130	20	175	175		
	perlitic		230	21	165	165		
N Aluminium wrought alloys Cast aluminium alloys Copper and copper alloys (bronze/brass)	cannot be hardened		60	22	800	800		
	hardenable	hardened	100	23	600	600		
	$\leq 12\% \text{ Si}$, cannot be hardened		75	24	320	320		
	$\leq 12\% \text{ Si}$, hardenable	hardened	90	25	240	240		
	$> 12\% \text{ Si}$, cannot be hardened		130	26	160	160		
	machining steel, PB > 1%		110	27	160	160		
	CuZn, CuSnZn		90	28	600	600		
S Heat-resistant alloys Titanium alloys	CuSn, Pb-free copper, electrolytic copper		100	29	200	200		
	Fe-based alloys	annealed	200	30	95	95		
		hardened	280	31	50	50		
		annealed	250	32	80	80		
		hardened	350	33	70	70		
	Ni or Co bass	cast	320	34	70	70		
		pure titanium	R_m 400	35	145	145		
α and β alloys	hardened	R_m 1050	36	50	50			
H Hardened steel Hard cast iron Hardened cast iron	hardened and tempered	55 HRC	37					
	hardened and tempered	60 HRC	38					
	cast	400	39					
X Non-metallic materials	hardened and tempered	55 HRC	40					
	Thermoplasts		41					
	Thermosetting plastics		42					
	Plastic, glass-fibre reinforced GFRP		43					
	Plastic, carbon fibre reinforced CFRP		44					
	Graphite		45					
Wood		46						

Note: The given cutting values are guide values, which were determined under ideal conditions. The values have to be adapted in individual cases. For examples of material for cutting tool groups view page D11.

HC Coated carbide

Technical information

Trouble shooting - turning

A502-A504

Technical Information - turning

A505-A512

Special tools – turning

A513

A

A

Turning

B

Milling

C

Drilling

D

Technical
Information

E

Index

Trouble shooting – general turning

Fig.	Type of wear	Effects	Reason	Countermeasure
1+2	Flank wear	<ul style="list-style-type: none"> – Bad surface quality and dimensional stability – Increase of cutting force 	<ul style="list-style-type: none"> – Grade not wear-resistant enough – Cutting speed too high – Clearance angle too small – Feed rate too low 	<ul style="list-style-type: none"> – Grade with higher wear-resistance – Reduce cutting speed – Increase clearance angle – Reduce feed rate
3	Crater wear	<ul style="list-style-type: none"> – Bad surface quality and chip control 	<ul style="list-style-type: none"> – Grade not wear-resistant enough – Cutting speed too high – Feed rate too low 	<ul style="list-style-type: none"> – Grade with higher wear-resistance – Reduce cutting speed – Reduce feed rate
4	Chipping	<ul style="list-style-type: none"> – Unstable tool life – Sudden breakage of cutting edge 	<ul style="list-style-type: none"> – Grade too hard – Feed rate too high – Cutting edge not stable enough – Stability of the holder or tension insufficient 	<ul style="list-style-type: none"> – Grade with higher toughness – Reduce feed rate – Change honing of cutting edge – Use a more stable tool holder
5	Breakage	<ul style="list-style-type: none"> – Increase of cutting force – Bad surface quality and dimensional stability 	<ul style="list-style-type: none"> – Grade too hard – Feed rate too high – Cutting edge not stable enough – Stability of the holder or tension insufficient 	<ul style="list-style-type: none"> – Grade with higher toughness – Reduce feed rate – Change honing of cutting edge – Use a more stable tool holder
6	Plastic deformation	<ul style="list-style-type: none"> – Bad dimensional stability – Damage to cutting edge 	<ul style="list-style-type: none"> – Grade not wear-resistant enough – Cutting speed too high – Cutting depth and/or feed rate too high – Temperature on the cutting edge too high 	<ul style="list-style-type: none"> – Grade with higher toughness – Reduce cutting speed – Reduce cutting depth and feed rate – Grade with higher heat-resistance
7	Welding	<ul style="list-style-type: none"> – Increase of cutting force – Bad surface quality 	<ul style="list-style-type: none"> – Cutting speed too low – Cutting edge not sharp enough – Grade not suitable 	<ul style="list-style-type: none"> – Increase cutting speed – Increase rake angle – Use a more suitable grade
8	Thermal cracks	<ul style="list-style-type: none"> – Breakage due to thermal interaction, often caused when cutting is interrupted (milling) 	<ul style="list-style-type: none"> – Temperature fluctuation when machining – Grade too hard 	<ul style="list-style-type: none"> – Dry machining – Grade with higher toughness
9	Notch wear	<ul style="list-style-type: none"> – Burr formation – Increase of cutting force 	<ul style="list-style-type: none"> – Damage through chips (jagged edges) – Feed rate and cutting speed too high 	<ul style="list-style-type: none"> – Grade with higher wear-resistance – Increase rake angle to get a sharper cutting edge – Reduce cutting speed
10	Flaking (coating)	<ul style="list-style-type: none"> – Often appears when machining hardened materials or caused by vibration 	<ul style="list-style-type: none"> – Cutting edge adhesion and chipping – Bad chip removal 	<ul style="list-style-type: none"> – Increase rake angle to get a sharper cutting edge – Chip breaker with bigger chip space

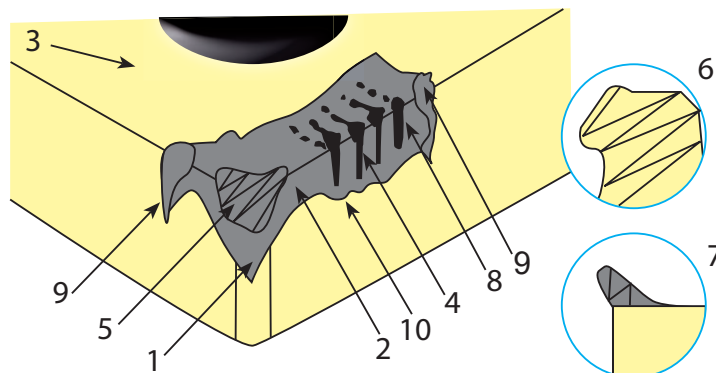

Trouble shooting – PCBN & PCD

Type of wear	Countermeasure	
	Geometry	Cutting condition
Flank wear	<ul style="list-style-type: none"> - Sharper cutting edge for reduced cutting force - Smaller negative chamfer - Use positive inserts 	<ul style="list-style-type: none"> - Reduce cutting speed - Increase feed rate to reduce operation time
Notch wear	<ul style="list-style-type: none"> - Bigger radius 	<ul style="list-style-type: none"> - Use "method of altering feed rate"
Crater wear/breakage due to crater wear	<ul style="list-style-type: none"> - Sharper cutting edge for reduced cutting force 	<ul style="list-style-type: none"> - Reduce cutting speed - Increase feed rate to minimise operation time and to increase distance between cutting edge and crater
Chipping due to rough condition or vibration	<ul style="list-style-type: none"> - Bigger negative chamfer angle and/or honed chamfer 	<ul style="list-style-type: none"> - Increase feed rate to reduce number of hits
Flaking	<ul style="list-style-type: none"> - Sharper cutting edge to reduce cutting force - Smaller negative chamfer - Use positive inserts 	<ul style="list-style-type: none"> - Increase feed rate to reduce operation time
Thermal crack/breakage	<ul style="list-style-type: none"> - Sharper cutting edge for reduced cutting force - Smaller negative chamfer - Use positive inserts 	<ul style="list-style-type: none"> - Reduce cutting speed, feed rate and depth of cut - Dry machining
Chipping	<ul style="list-style-type: none"> - Bigger negative chamfer 	<ul style="list-style-type: none"> - Increase cutting speed to reduce cutting force

For investigation please send us the used inserts. If breakage is the problem please use inserts only 80–90% of expected tool life because broken inserts almost have no information.

A

Turning

B

Milling

C

Drilling

D

Technical Information

E

Index

Trouble shooting – threading

Problème	Cause	Solution
Big flank wear	– Cutting speed too high	– Reduce cutting speed
	– Width of cut too small	– Reduce number of width of cut
	– Insert over/under centre line	– Adjust insert height
Asymmetric wear on left and right cutting edge	– Width of cut not optimal	– Adjust width of cut
	– Inclination angle and lead angle are not optimally aligned	– Change the shim to get the correct angle
Breakage	– Cutting speed too low	– Increase cutting speed
	– Cutting force too high	– Increase number of width of cut – Reduce width of cut
	– Unstable conditions	– Improve clamping and overhang to avoid vibrations
	– Bad chip control	– Increase coolant pressure for better chip removal
Déformation plastique	– Cutting speed and temperature too high	– Reduce cutting speed – Increase number of width of cut – Reduce width of cut
	– Insufficient coolant supply	– Improve coolant supply
Mauvais état de surface du filet	– Cutting speed too low	– Increase cutting speed
	– Insert over/under centre line	– Adjust insert height
	– Bad chip control	– Change feed rate and/or width of cut
Profil de filet incorrect	– Incorrect insert height	– Change insert height
	– Tool holder doesn't form a 90° angle	– Adjust tool holder
	– Pitch error in machine	– Adjust machine
Profil de filetage de profondeur insuffisante	– Incorrect insert height	– Change insert height
	– Breakage of cutting edge	– Change insert
	– Excessive wear	– Change insert
Formation d'arêtes rapportées	– Temperature on cutting edge is too low	– Increase cutting speed
	– Often occurs when machining of carbon steel and stainless steel	– Use grade with sufficient toughness (PVD coated)
Vibrations	– Incorrect cutting data	– Increase or highly decrease cutting speed
	– Incorrect insert height	– Change insert height
	– Insufficient clamping	– Improve clamping system and minimise overhang

A

Turning

B

Milling

C

Drilling

D

Technical Information

E

Index

General turning

Cutting tool geometry

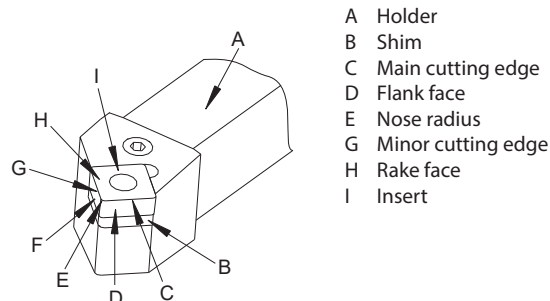
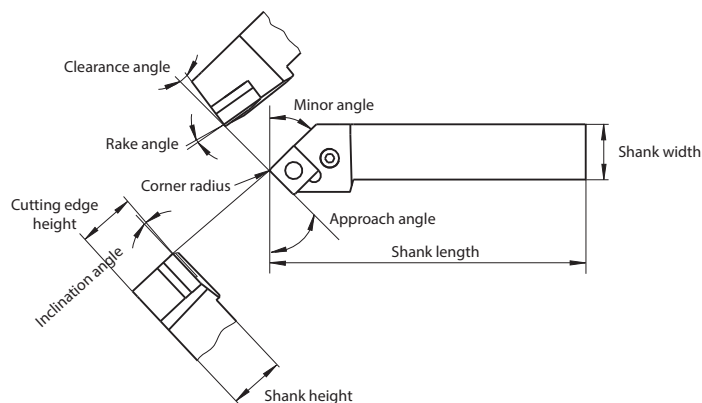

- A Holder
- B Shim
- C Main cutting edge
- D Flank face
- E Nose radius
- G Minor cutting edge
- H Rake face
- I Insert

Rake angle

The rake angle is a cutting edge angle that has large effects on cutting resistance, chip disposal, cutting temperature and tool life. Increasing the rake angle in positive direction improves the sharpness of the cutting edge and the cutting force decreases but at the same time it lowers the strength. To increase the cutting resistance the rake angle must be increased in negative direction.

Rake angle	Applications
Small	Machining of fragile and hard materials, roughing and interrupted cut
Large	Machining of plastic materials and soft materials, precision machining

Clearance angle

The flank angle prevents friction between the flank face and work piece resulting in smooth feed. Increasing the flank angle decreases the cutting force and the surface roughness becomes better but on the other hand this lowers the cutting edge strength and decreases the flank wear occurrence.

Clearance angle	Applications
Small	Machining of hard and demure materials, for roughing operation with stable cutting edge
Large	Precision machining with low cutting force, work pieces suffer from work hardening easily

Inclination angle

The positive and negative edge inclination angle determines the discharging direction of chips. In heavy cutting, the cutting edge receives extremely large shocks at the beginning of cutting. Cutting edge inclination keeps the cutting edge from receiving this shock and prevents fracturing. On the other hand the back force increases and occurs vibration. For a finishing operation a positive angle is more suitable.

When the edge inclination angle is negative, i.e. the cutting edge is located at the lowest point relative to the bottom plane of the tool holder, the chips flow to the machined surface of workpiece.

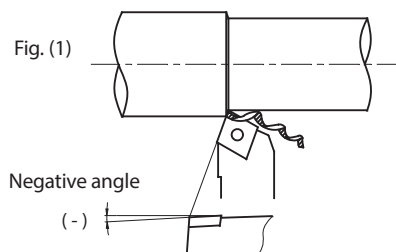

As shown in Fig. (2), when the edge inclination angle is positive, i.e. the cutting edge is located at the highest point relative to the bottom plane of the tool holder, the chips flow to the un-machined surface of workpiece.

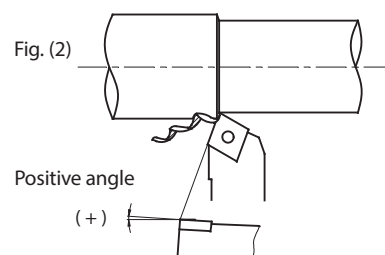

A

Turning

B

Milling

C

Drilling

D

Technical Information

E

Index

A

Turning

General turning

Entering angle (main cutting edge)

Reducing the lead angle increases the strength of the cutting edge. Because the lead angle is small, the cutting width is long, the force on the unit cutting edge length is small. At the same time, reducing the lead angle can increase the tool life. Normally, when turning thin long shaft and ladder shaft, the lead angle adapts 90°. The lead angle is increased, radial force is reduced, cutting is stable, cutting thickness is increased and chip breaking performance is good.

Entering angle	Applications
Small	For material with high tensile strength, high hardness or hardened layer on surface
Large	For machining with low rigidity

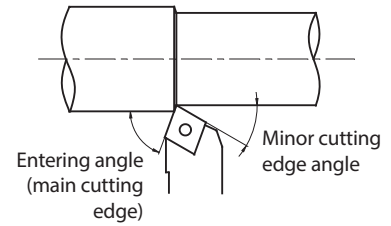

B

Milling

Minor cutting edge

The minor cutting edge angle is the main angle on influence surface roughness; its size is also influence strength of cutter. When the minor cutting edge angle is too small, the cutting force increases and results in chattering and vibration. The selection principle for the minor cutting edge angle is under the condition of rough machining, or un-influencing friction and producing vibration, the smaller angle should be chosen; the bigger angle can be used for precision machining.

Nose radius

The nose radius effects the cutting edge strength and the finished surface. By increasing the nose radius the surface finish becomes better and the cutting edge strength improves. Flank and rake wear decreases. If the radius becomes too big, the cutting force increases and causes vibration which effects the chip control negative.

Radius	Applications
Small	Finishing with small cutting depth, machining thin long shaft, rigidity of machine is insufficient
Large	Rough machining, high cutting edge strength is required, rigidity of machine is good, machining hardened materials and interrupted cut

C

Drilling

D

Technical Information

E

Index

General turning

Cutting speed V_c

$$V_c = \frac{\pi \times D \times n}{1000} \text{ [m/min]}$$

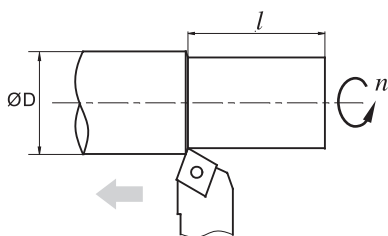

External machining

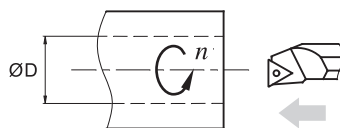

Internal machining

V_c : Cutting speed [m/min]
 n : Revolution [1/min]
 f : Feed rate [mm]

Example: $n = 250$ 1/min, $f = 0,2$ mm,
 $l = 150$ mm

Result: [insert values in formula V_c]

Feed rate F

$$f = \frac{l}{n} \text{ [mm/rev]}$$

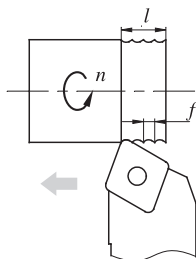

f : Feed rate [mm]
 l : Cutting length [mm/min]
 n : Revolution [1/min]

Example: $n = 500$ 1/min, $l = 100$ mm/min
 Result: [insert values in formula f]

$$f = \frac{l}{n} = \frac{100}{500} = 0,2 \text{ mm}$$

Cutting time T_c

$$T_c = \frac{l}{f \times n} \text{ [min]}$$

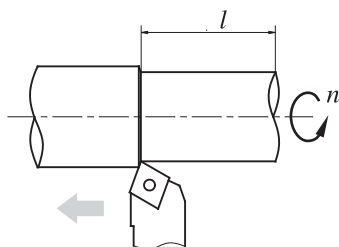

External machining

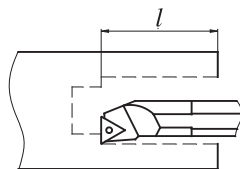

Internal machining

T_c : Cutting time [min]
 l : Cutting length [mm/min]
 f : Feed rate [mm]
 n : Revolution [1/min]

Example: $n = 250$ 1/min, $f = 0,2$ mm,
 $l = 150$ mm

Result: [insert values in formula T_c]

A

Turning

B

Milling

C

Drilling

D

Technical Information

E

Index

A

General turning

Cutting time T_C for face milling

$$T_C = \frac{\pi \times (a^2 - b^2)}{4000 \times V_C \times f} \text{ [min]}$$

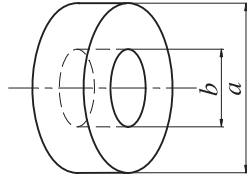

T_C : Cutting time [min]
 V_C : Cutting speed [m/min]
 f : Feed rate [mm]

Turning

B

Theoretical surface roughness R

$$R = \frac{f^2}{8r_c} \times 1000 \text{ [\mu m]}$$

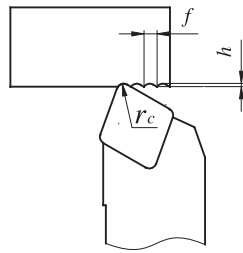

R: Surface roughness [μ m]
f: Feed rate [mm]
 r_c : Radius of insert [mm]

Example: $f = 0,2$ mm,
 $r_c = 0,4$ mm

Milling

C

Drilling

D

Technical Information

E

Index

General turning

Three effects of cutting condition for turning

Today short machining time, long tool life and high machining accuracy is expected from modern tools. Based on the machine performance, material shape and hardness of the components the right choice of tool and cutting conditions are the premise for a successful machining process. Cutting speed, feed rate and depth of cut are what we call the “Three effects of cutting”.

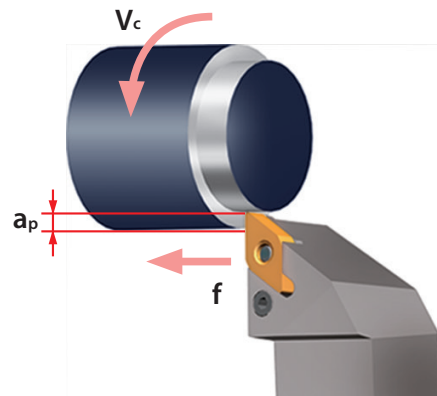

1. Cutting speed (V_c)

Cutting speed is defined as the rate (or speed) that the material moves past the cutting edge of the tool. The unit for V_c is meter per minute [m/min].

Cutting speed influence: Cutting speed is one of the three important effects of turning and has influence on tool life. Increasing the cutting speed also increases the cutting temperature and that decreases the tool life. Depending on the hardness and type of material the cutting speed varies. Therefore to choose a suitable grade for the cutting speed is necessary.

In general situation, when cutting speed is increased by 20% the tool life will be reduced $\frac{1}{2}$; when the cutting speed is increased by 50% the tool life decreases $\frac{1}{3}$. Lower cutting speed results in vibration which will shorten tool life.

2. Feed rate (f)

In turning application feed rate is the distance the tool holder moves per work piece revolution. That has influence to the surface quality. The unit for feed rate is millimetre per revolution [mm/rev]

Feed rate influence: Decreasing the feed rate will increase flank wear and tool life will be shortened. Increasing the feed rate increases the cutting temperature and also flank wear. On the other hand the efficiency will be improved.

3. Depth of cut (a_p)

The depth of cut refers to the half different value between the diameter of the unmachined and machined work piece. The unit is millimetre [mm].

Depth of cut influence: Changing depth of cut has no big influence to the tool life. Machining hardened layer with small depth of cut results in friction and short tool life. Machining uncut surface or cast iron material, choose maximum depth of cut according to the machine power so that the cutting edge and corner radius is out of the hardened layer. That helps to prevent chipping and abnormal wear.

A

Turning

B

Milling

C

Drilling

D

Technical Information

E

Index

A

Parting & grooving

Adjusting the cutting edge height

- Mount the tool holder in a 90° angle to the central axis of the workpiece. This improves the surface quality and decreases the risk of vibrations.

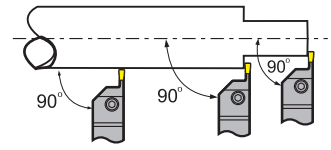

- Height tolerance between the cutting edge of the insert and the centre of the work piece should be kept ± 0.1 mm, especially for parting of rods and grooving of materials with a small diameter. This extends the tool life and reduces the cutting forces as well as the formation of burrs.

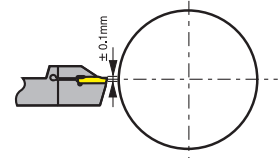

Turning

B

Parting off

- When the cutting edge nears the central axis of the work piece, reducing the feed rate by 30 % can extend the tool life of the insert.
- Pick a tool holder with the smallest possible overhang to avoid vibrations and tool deflection.

Milling

C

Longitudinal turning and profile turning

- Machining sequence 0.5 mm:
 1. Bring radial feed rate to required cutting depth (ap max. $0.75 \times$ cutting edge width)
 2. Radial relocating by 0.1 mm
 3. Longitudinal turning to opposite shoulder
 4. Diagonal relocating by 0.5 mm outward axial feed rate to the starting point
 5. Radial feed rate to required cutting depth, etc.

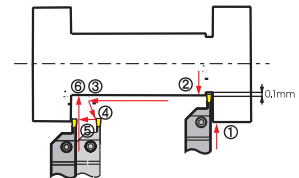

- When machining the chamfer or the base of the slot follow the steps as shown in figure. This reduces tool deflection and avoids cutting edge chipping.

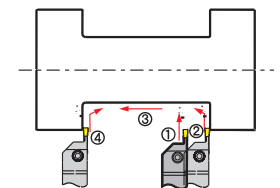

Drilling

D

Surface grooving and turning

- Roughing: Processing from largest diameter to the axis. When returning it's recommended to bend the tool slightly.

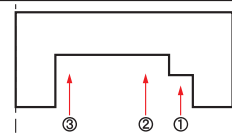

- Flute turning: Depth of axial turning less than $0.75 \times S$ (width of insert). When the pocket width is bigger than the depth follow the working steps as shown. When the pocket depth is bigger than the width, we recommend to go to the required diameter step by step.

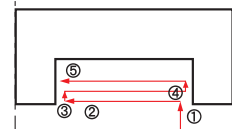

- Finishing: When finishing begin with the outer diameter and the bottom. Then go on with the inner diameter to the required size.

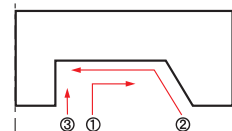

Technical Information

E

Internal machining

- Procedure according to figure. For better chip removal in blind holes machine from the inside out.

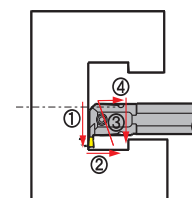

Index

Threading

Steps for best results when thread-cutting

1. Choice of threading method
2. Choice of angle and shim
3. Choice of tool holder and inserts
4. Choice of cutting data
5. Choice of cutting direction

Thread turning method

External machining

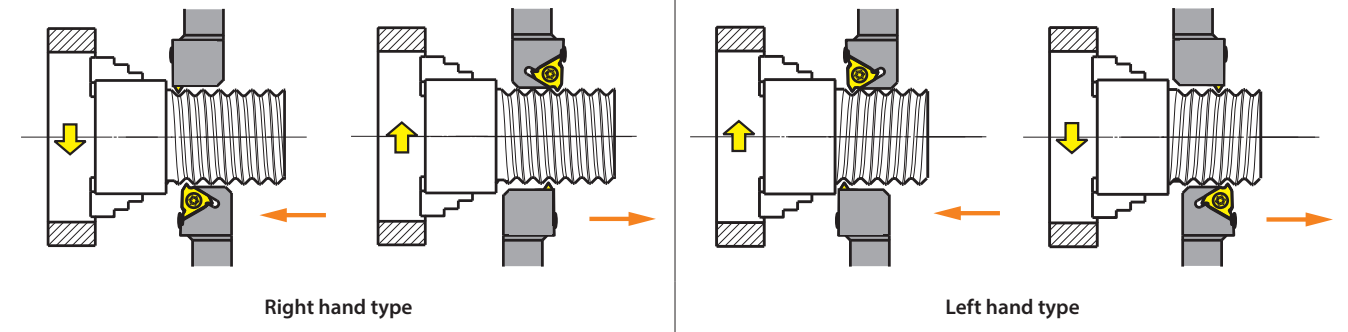

Internal machining

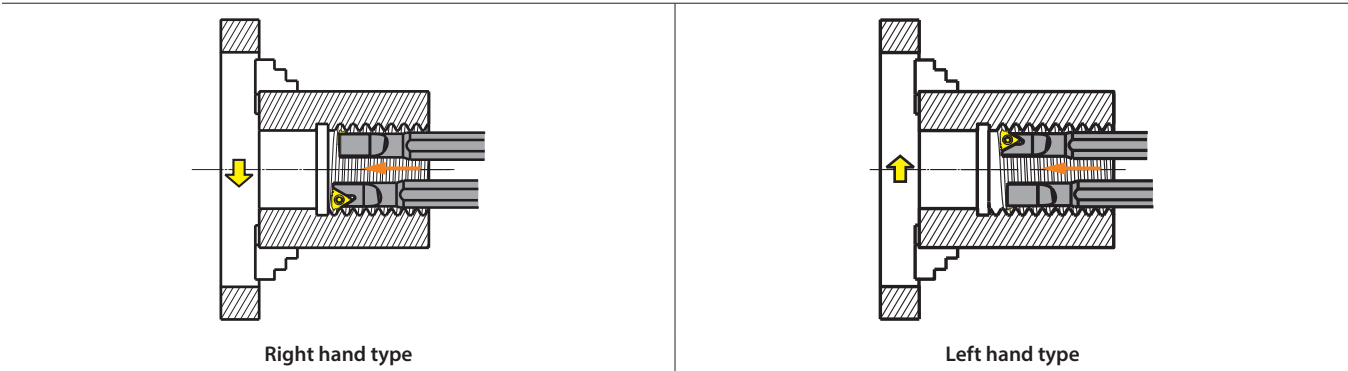

A

Turning

B

Milling

C

Drilling

D

Technical
Information

E

Index

A

Choice of angle and shim

Choice of angle

The flank clearance angles of the thread profile depend on the helical angle of the thread. The helical angle of the thread must coincide with the insert's angle of inclination angle as far as possible to get the ideal profile, to avoid longer unfavourable wear on one of the flanks and thus to ensure tool life.

$$\lambda = \arctan \frac{p}{d_2 \times \pi}$$

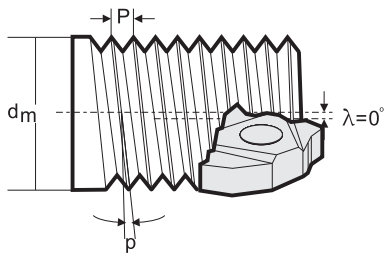

Helix angle (p)

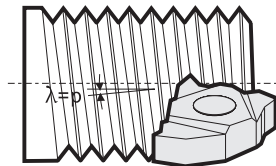

Pitch angle (λ)

p Pitch
d₂ Flank diameter
λ Pitch angle

Turning

B

Milling

C

Choice of shim

Pitch range	Dimension	Pitch angle	Shim
0,5–0,3	16	0	MT16-00M
		1	MT16-01M
		2	MT16-02M
		3	MT16-03M
3,5–6,0	22	0	MT22-00M
		1	MT22-01M
		2	MT22-02M
		3	MT22-03M

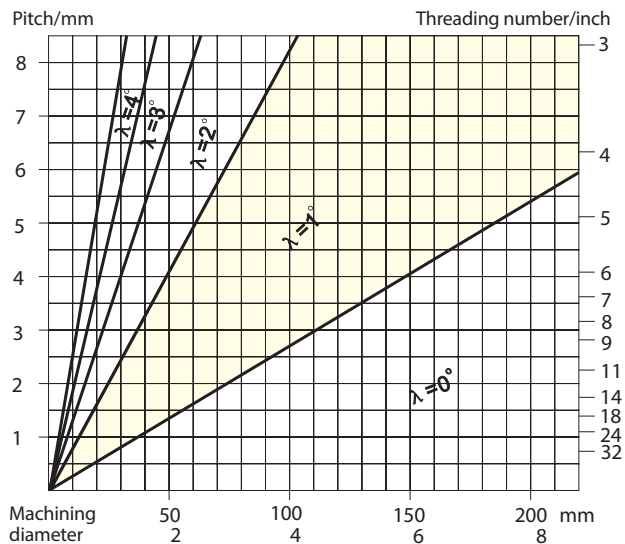

The shim $\lambda = 1^\circ$ is delivered with the tool holder.

Drilling

D

Technical Information

Infeed way of threading

The number of passes and widths of cut are the key points of threading operation. Please choose the cutting parameters with the recommended form according to experience data. In case of breakages or too much wear please have a look at page A447 (trouble shooting).

E

Index

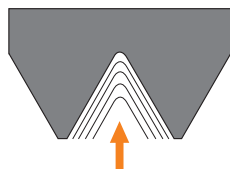

Radial width of cut

Radial width of cut requires low cutting depth, sharp cutting edge and tough grade. It is recommended when the pitch is smaller than 2 mm, not ideal for material with long chips.

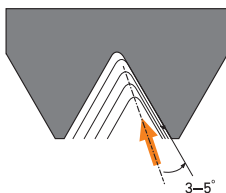

Modified flank width of cut

Infeed at an angle of 3–5° to the flank of the teeth. It is easy for chips flow. Suitable for long chip material and internal threading.



Alternating width of cut

Alternating width of cut is mainly used for large pitches and long chip materials. To get equal insert wear on both edges.

Go directly to the special tool tailored for your turning applications

Are there turning applications at your company where having custom tools tailored to your unique needs would deliver real benefits both in terms of logistics and at a technical and commercial level? ZCC Cutting Tools Europe is there to advise and assist you during the planning, development and ordering process. Use our new online tool to request a special tool and get your personal quotation in just a few short steps (<https://www.zcct-europe.com/en/tools/special-tools/>).

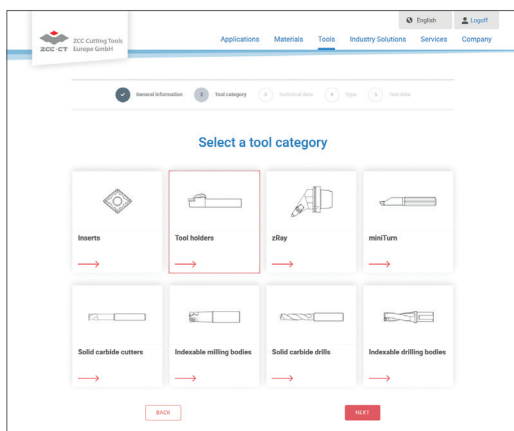

'Online tool for special tools' launch page where you can select the tool category

Selecting the tool category

Scan the QR code on this page to go directly to the launch page of our online tool where you can request the special tool you need. You can begin by selecting the tool category you need. It's that easy.

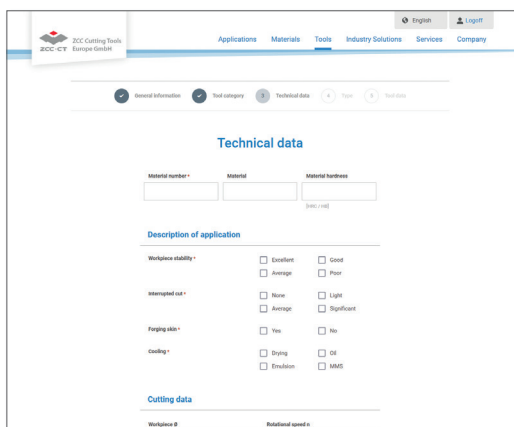

Define the relevant tool parameters.

Defining the tool parameters

You are now guided step by step through the process. You can also securely upload your drawings, diagrams and 3D models (where available).

It's the easy way to order your custom-made special tool from ZCC Cutting Tools Europe GmbH.



Now go directly to the new **special tool form** on our website and get started.

INDEXABLE MILLING



A

Turning

B

Milling

C

Drilling

DTechnical
Information**E**

Index

B









Indexable milling

Product overview	B2-B3
System overview	B4-B19
Chip breaker overview	B20
Grade overview	B21-B23
Application fields of grades	B24-B25
System code – milling bodies	B26-B27
ISO code – inserts	B28-B29
System code – slot milling	B30
System code – QCH series	B31-B32
Face milling	B33-B102
Square shoulder milling	B103-B132
Profile milling	B133-B150
Slot milling	B151-B162
High feed milling	B163-B172
Bore milling	B173-B174
T-slot milling	B175-B176
Helical milling	B177-B182
Chamfer milling	B183-B194
QCH series	B195-B217
General milling inserts	B218-B229
Recommended cutting data	B230-B263
Trouble shooting	B528
Technical information	B529-B536
Special tools	B541

Milling inserts









A

Turning

								
ANGX-GM	ANGX-LH	APKT-ALH	APKT-APF	APKT-APM	APKT-LH	APKT-NM	APKT-PF	
11 15	11 15	11 16	11 16	07 11 16	11 16	11	11 16	Edge length
B124, B126, B128, B130, B132	B124, B126, B128, B130, B132	B104, B107, B111, B114, B116, B202, B213	B104, B107, B111, B114, B116, B202, B213	B104, B107, B111, B114, B116, B202, B213	B104, B107, B111, B114, B116, B202, B213	B104, B107, B111, B114, B116, B202, B213	B104, B107, B111, B114, B116, B202, B213	Page









B

Milling

								
APKT-PM/PR	APKT-XR	APMT	CNE-A/B	HNEX-DR	HNGX-HDR	HNGX-MR	LNCX	
11 15 16	11	11 16	12	09	09	09	18	Edge length
B104, B107, B111, B114, B116, B202, B213	B104, B107, B111, B114, B116, B202, B213	B118	B174	B64	B218	B218	B220	Page









C









Drilling









								
LNE32.534	LNKT-GL	LNKT-GM	LNKT-ZR	MPHT-DM	ODHT-GH	ODHT-GL	ODHT-GM	
	08 12 16	08 12 16	12 15 20 25	06 08 12	06	06	06	Edge length
B219	B120, B122	B120, B122	B66, B73, B80	B156, B158, B176	B47	B47	B47	Page

D

Technical Information









								
ODHT-LH	ODMT-GM	OFKR-DF	OFKR-DM	OFKR-LH	OFKT-DF	OFKT-DM	OFKT-LH	
06	06	07	07	07	05	05	05	Edge length
B47	B47	B45	B45	B45	B43	B43	B43	Page

								
ONHU-CM	ONHU-GH	ONHU-GL	ONHU-GM	ONHU-PF	ONHU-PM	PNEG-CF	PNEG-CM	
06 08	06	06	06 08	06 08	06 08	11	11	Edge length
B49, B51	B56	B56	B56	B49, B51	B49, B51	B59, B61	B59, B61	Page









								
PNEG-CR	PNEG-PF	PNEG-PM	PNEG-PR	RCKT-DM	RCKT-DR	RCKT-ER	RCKT-NM	
11	11	11	11	10 12 16 20	12 16 20	12 16 20	12 16 20	Edge length
B59, B61	B58, B61	B58, B61	B58, B61	B89, B92	B89, B92	B89, B92	B89, B92	Page









E









Index









								
RDKT-MM	RDKW	ROHX	SDMT	SDMT-DM	SDMT-NM	SDMT-PM	SEEN	
10 12	07 08 10 12 16 20	12 16 20	09	06 09 12 15	09 12	06 09 12 15	12	Edge length
B95, B99, B205	B95, B99, B205	B137	B135	B164, B167, B198, B211	B164	B164, B167, B198, B211	B41	Page









Milling inserts









								
SEET-APF	SEET-APM	SEET-APR	SEET-CF	SEET-CM	SEET-CR	SEET-DF	SEET-DM	
09 12	09 12	09 12	12	12	12	12	12 18	Edge length
B77	B77	B77	B35, B37	B35, B37	B35, B37	B35, B37	B35, B37	Page

								
SEET-DR	SEET-EF	SEET-EM	SEET-LH	SEET-PF	SEET-PM	SEET-PR	SEET-W	
12	12	12	12	09 12	09 12	09 12	12	Edge length
B35, B37	B35, B37	B35, B37	B35, B37	B77	B77	B77	B34, B37	Page

								
SEKN	SEKR	SNEG-E	SNEG-GM	SNEG-GR	SNEG-HGR	SNEG-W	SNKN	
12 15	12	15	12 15	12 15 19	15	12	12 15	Edge length
B40	B41	B53	B53	B53	B53	B54	B221	Page

								
SPCN	SPGN	SPKN	SPKR	SPKR-GM	SPKT	SPKW	SPMR	
12 15	12	12 15	12	12 15	12	12	09 12	Edge length
B222	B225	B70	B71	B71	B68	B68	B223	Page

								
SPMT	SPMT-HT	SPMT-KT	SPMT-PM	SPUN	TPKN	TPMR	TPUN	
06 09 12	09 12	06	12	12 15	16 22	11 16 22	11 16 22	Edge length
B135, B184, B186, B188, B190, B192, B194	B224	B135, B224	B178, B180, B182	B225	B75, B226	B227	B227	Page

								
WPGT	WPGT-PM	XEEC	XPHT-GM	XSEQ	ZDET	ZDET-PM	ZOHX-GF	
05 06 08 09	05 06 08 09	12	16 20 25 30 32 40 50	12	08 11	13	12 16 20 25 30 32	Edge length
B169, B171, B200	B169, B171, B200	B87	B139, B141, B143, B145, B196	B152, B154	B134	B134	B147, B149, B209	Page

		
ZOHX-GM	ZPNT	
12 16 20 25 30 32	22	Edge length
B147, B149, B209	B134	Page

A

Turning

B

Milling

C

Drilling









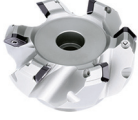

D

Technical Information

E

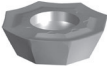
Index

Face milling

Series	Milling body	Inserts	Kr	Application						Features	Page
				P	M	K	N	S	H		
FMA01		 SEET12T3 SEET18T6	45°	✓	✓	✓	✓	✓		<ul style="list-style-type: none"> • Diameter range Ø50 – 315 mm • For steel, stainless steel, cast iron, non-ferrous metals and heatresistant alloys • Milling cutter with positive, soft cutting geometry • Wiper inserts for good surface quality 	B33
FMA02		 SEET12T3	45°	✓	✓	✓	✓	✓		<ul style="list-style-type: none"> • Diameter range Ø50 – 125 mm • For steel, stainless steel, cast iron, non-ferrous metals and heatresistant alloys • Milling cutter with positive, soft cutting geometry • Wide pitch 	B36
FMA03		 SEEN1203 SEKN1203 SEKR1203 SEKN1504 SEKR1504	45°	✓	✓	✓	✓			<ul style="list-style-type: none"> • Diameter range Ø80 – 315 mm • For steel, stainless steel and cast iron • Milling cutter with positive, soft cutting geometry • Wedge clamping 	B39
FMA04		 OFKT05T3	45°	✓	✓	✓	✓			<ul style="list-style-type: none"> • Diameter range Ø50 – 160 mm • For steel, stainless steel, cast iron and non-ferrous metals • Inserts with eight cutting edges • Screw clamping 	B42
FMA04		 OFKR0704	45°	✓	✓	✓	✓			<ul style="list-style-type: none"> • Diameter range Ø125 – 315 mm • For steel, stainless steel, cast iron and non-ferrous metals • Inserts with eight cutting edges • Wedge clamping 	B44
FMA04		 OD*T0605**	45°	✓	✓	✓	✓			<ul style="list-style-type: none"> • Diameter range Ø50 – 160 mm • For steel, stainless steel, cast iron and non-ferrous metals • Inserts with eight cutting edges • Screw clamping 	B46

✓ Very suitable ✓ Suitable

A
Turning













B
Milling

C
Drilling

D
Technical Information

E
Index

Face milling

Series	Milling body	Inserts	Kr	Application						Features	Page	
				P	M	K	N	S	H			
FMA07		 ONHU0604 ONHU08T5	45°	✓		✓				✓	<ul style="list-style-type: none"> • Diameter range Ø25 – 50 mm • For steel and cast iron • Inserts with 16 cutting edges 	B48
FMA07		 ONHU0604 ONHU08T5	45°	✓		✓				✓	<ul style="list-style-type: none"> • Diameter range Ø40 – 315 mm • For steel and cast iron • Inserts with 16 cutting edges 	B50
FMA11		 SNEG1205 SNEG1506 SNEG1907	45°	✓	✓	✓			✓		<ul style="list-style-type: none"> • Diameter range Ø63 – 315 mm • For steel, stainless steel and cast iron • Inserts with eight cutting edges • Double sided, thicker inserts for high stability and deeper cutting depths • Wiper geometry for good surface quality • Normal and fine pitch 	B52
FMA12		 ON*U0604** ONHU08T6	45°	✓	✓	✓			✓		<ul style="list-style-type: none"> • Diameter range Ø63 – 315 mm • For steel, stainless steel and cast iron • Inserts with 16 cutting edges 	B55
FMD02		 PNEG1105	67°	✓	✓	✓					<ul style="list-style-type: none"> • Diameter range Ø50 – 315 mm • For steel, stainless steel and cast iron • Inserts with ten cutting edges • Wedge clamping or screw clamping • Normal and fine pitch 	B57
FMD02		 PNEG1105	67°			✓					<ul style="list-style-type: none"> • Diameter range Ø50 – 315 mm • For steel, stainless steel and cast iron • Inserts with ten cutting edges • Wedge clamping or screw clamping • Normal and fine pitch 	B60

✓ Very suitable ✓ Suitable

A

Turning

B

Milling

C

Drilling











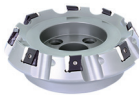

D

Technical Information

E

Index

Face milling

Series	Milling body	Inserts	Kr	Application						Features	Page	
				P	M	K	N	S	H			
FMD02		 HNEX0905	55°			✓					<ul style="list-style-type: none"> • Diameter range Ø80 – 315 mm • For cast iron • Wedge clamping • Inserts with twelve cutting edges 	B63
FMD03		 LNKT2007-ZR LNKT2510-ZR	60°	✓		✓					<ul style="list-style-type: none"> • Diameter range Ø100 – 400 mm • For steel, stainless steel and cast iron • Tangential insert with four cutting edges • Heavy duty machining for high cutting depths • Screw clamping 	B65
FME02		 SPKT1204 SPKW1204	75°	✓	✓	✓					<ul style="list-style-type: none"> • Diameter range Ø50 – 125 mm • For steel and cast iron • Screw clamping 	B67
FME03		 SPKN1203 SPKR1203 SPEX1203 SPKN1504 SPKR1504 SPEX1504	75°	✓	✓	✓					<ul style="list-style-type: none"> • Diameter range Ø80 – 400 mm • For steel and cast iron • Wedge clamping 	B69
FME04		 LNKT1506-ZR	75°	✓		✓					<ul style="list-style-type: none"> • Diameter range Ø125 – 315 mm • For steel, stainless steel and cast iron • Tangential insert with four cutting edges • Heavy duty machining for high cutting depths • Screw clamping 	B72
FMP01		 TPKN2204	90°	✓	✓	✓			✓		<ul style="list-style-type: none"> • Diameter range Ø80 – 315 mm • For steel, stainless steel and cast iron • Milling cutter with positive, soft cutting geometry • Wedge clamping 	B74

✓ Very suitable ✓ Suitable

A
Turning













B
Milling

C
Drilling

D
Technical Information

E
Index

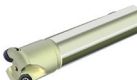
Face milling

Series	Milling body	Inserts	Kr	Application						Features	Page
				P	M	K	N	S	H		
FMP02		 SEET09T3 SEET1203	90°	✓	✓	✓	✓	✓		<ul style="list-style-type: none"> • Diameter range Ø50 – 315 mm • For steel, stainless steel, cast iron an non-ferrous metals • Screw clamping 	B76
FMP03		 LNKT120608-ZR LNKT1506EN-ZR LNKT2007DN-ZR LNKT2510-ZR	89°	✓		✓				<ul style="list-style-type: none"> • Diameter range Ø50 – 315 mm • For steel, stainless steel and cast iron • Tangential insert with four cutting edges • Screw clamping 	B79
FMP12		 WNHU0604 WNHU0806	90°	✓		✓				<ul style="list-style-type: none"> • Diameter range Ø50 – 315 mm • For steel, stainless steel and cast iron • Tangential insert with four cutting edges • Screw clamping 	B81
FMP12		 WNHU0604	90°	✓		✓				<ul style="list-style-type: none"> • Diameter range Ø50 – 315 mm • For steel, stainless steel and cast iron • Tangential insert with four cutting edges • Screw clamping 	B83
FMWX		 XEEC1209		✓		✓				<ul style="list-style-type: none"> • Diameter range Ø50–125 mm • High feed finishing cutters for steel and cast materials • Inserts with four cutting edges • Reserve insert seats for increased safety • The milling body is only equipped with two opposing inserts 	B86
FMR01		 RCKT10T3 RCKT1204 RCGX1204		✓	✓	✓	✓	✓		<ul style="list-style-type: none"> • Diameter range Ø25 – 63 mm • For steel, stainless steel, cast iron, non-ferrous metals and heatresistant alloys • Screw clamping 	B88

✓ Very suitable ✓ Suitable

A
Turning











B
Milling

C
Drilling

D
Technical Information

E
Index

Face milling

Series	Milling body	Inserts	Kr	Application						Features	Page
				P	M	K	N	S	H		
FMR02		 RCGX1204 RCKT1204 RCMW1204 RCKT1606 RCKT2006		✓	✓	✓	✓	✓		<ul style="list-style-type: none"> • Diameter range Ø50 – 250 mm • For steel, stainless steel, cast iron, non-ferrous metals and heatresistant alloys • Screw clamping 	B90
FMR03		 RD**0803 RD**10T3 RD**1204		✓	✓	✓			✓	<ul style="list-style-type: none"> • Diameter range Ø15 – 50 mm • For steel, stainless steel and cast iron • Screw clamping • Mould and die industry 	B94
FMR03		 RDKW0702 RDKW1003		✓	✓	✓			✓	<ul style="list-style-type: none"> • Diameter range Ø15 – 50 mm • For steel, stainless steel and cast iron • Screw clamping • Mould and die industry 	B96
FMR04		 RD**1204 RD**1605 RD**2006		✓	✓	✓			✓	<ul style="list-style-type: none"> • Diameter range Ø50 – 200 mm • For steel, stainless steel and cast iron • Screw clamping • Mould and die industry 	B98
FMR04		 RDKW1003 RDKW12T3 RDKW1604		✓	✓	✓			✓	<ul style="list-style-type: none"> • Diameter range Ø42 – 200 mm • For steel, stainless steel and cast iron • Screw clamping • Mould and die industry 	B100

✓ Very suitable ✓ Suitable

A

Turning

B

Milling

C

Drilling











D

Technical Information

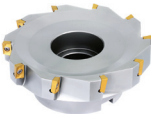
E

Index

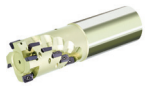
Square shoulder milling

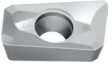
Series	Milling body	Inserts	Kr	Application						Features	Page
				P	M	K	N	S	H		
EMP01		 APKT0702 APKT11T3 APKT1604	90°	✓	✓	✓	✓	✓		<ul style="list-style-type: none"> • Diameter range Ø12 – 63 mm • For steel, stainless steel, cast iron, non-ferrous metals and heatresistant alloys • Weldon shank • For square shoulder milling, slot milling and ramping • Milling cutter with positive, soft cutting geometry • Inserts with two cutting edges 	B103
EMP01		 APKT11T3 APKT0702 APKT1604	90°	✓	✓	✓	✓	✓		<ul style="list-style-type: none"> • Diameter range Ø12 – 63 mm • For steel, stainless steel, cast iron, non-ferrous metals and heatresistant alloys • Weldon shank • For square shoulder milling, slot milling and ramping • Milling cutter with positive, soft cutting geometry • Inserts with two cutting edges 	B106
EMP02		 APKT0702 APKT11T3 APKT1604	90°	✓	✓	✓	✓	✓		<ul style="list-style-type: none"> • Diameter range Ø40–250 mm • For steel, stainless steel, cast iron, non-ferrous metals and heat-resistant alloys • For square-shoulder, slot and plunge milling • Milling cutter with positive, soft cutting geometry • INSERTs with two cutting edges 	B109
EMP03		 APKT11T3	90°	✓	✓	✓	✓			<ul style="list-style-type: none"> • Diameter range Ø50–100 mm • For steel, stainless steel, cast iron, non-ferrous metals and heat-resistant alloys • For square-shoulder, slot and plunge milling • Milling cutter with positive, soft cutting geometry • INSERTs with two cutting edges 	B113
EMP04		 APKT11T3	90°	✓	✓	✓	✓			<ul style="list-style-type: none"> • Diameter range Ø20–40 mm • For steel, stainless steel, cast iron, non-ferrous metals and heat-resistant alloys • For square-shoulder, slot and plunge milling • Milling cutter with positive, soft cutting geometry • INSERTs with two cutting edges 	B115
EMP05		 APMT1135	90°	✓	✓	✓				<ul style="list-style-type: none"> • Diameter range Ø25–40 mm • For steel, stainless steel and cast iron • Straight shank • For square-shoulder, slot and plunge milling • Milling cutter with positive, soft cutting geometry • INSERTs with two cutting edges • Machining in z-direction possible 	B117

✓ Very suitable ✓ Suitable

A

Turning

B

Milling

C

Drilling











D

Technical
Information

E





Index

Square shoulder milling





Series	Milling body	Inserts	Kr	Application						Features	Page
				P	M	K	N	S	H		
EMP09		 LNKT0804PNR LNKT1206PNR LNKT1607PNR	90°	✓	✓	✓				<ul style="list-style-type: none"> Diameter range Ø40 – 125 mm Sharp cutting edge geometry combined with robust tangential inserts First choice for large cutting depths with high feed rates. Specially designed cutting edge with high precision control for high quality 90 degree square shoulder milling 	B119
EMP09		 LNKT1206PNR	90°	✓	✓	✓				<ul style="list-style-type: none"> Diameter range Ø40 – 80 mm Sharp cutting edge geometry combined with robust tangential inserts First choice for large cutting depths with high feed rates. Specially designed cutting edge with high precision control for high quality 90 degree square shoulder milling 	B121
EMP13		 ANGX1105 ANGX1506	90°	✓	✓	✓	✓			<ul style="list-style-type: none"> Diameter range Ø40 – 250 mm For steel, cast iron and non-ferrous metals Double sided, thicker inserts for high stability and deeper cutting depths Inserts with four cutting edges 	B123
EMP13		 ANGX1105 ANGX1506	90°	✓	✓	✓	✓			<ul style="list-style-type: none"> Diameter range Ø25 – 40 mm For steel, cast iron and non-ferrous metals Double sided, thicker inserts for high stability and deeper cutting depths Inserts with four cutting edges 	B125
EMP13		 ANGX1105 ANGX1506	90°	✓	✓	✓	✓			<ul style="list-style-type: none"> Diameter range Ø25 – 40 mm For steel, cast iron and non-ferrous metals Double sided, thicker inserts for high stability and deeper cutting depths Inserts with four cutting edges 	B127

✓ Very suitable ✓ Suitable

Square shoulder milling

Series	Milling body	Inserts	Kr	Application						Features	Page
				P	M	K	N	S	H		
EMP13		 ANGX1105 ANGX1506	90°	✓	✓	✓	✓			<ul style="list-style-type: none"> • Diameter range Ø50 – 80 mm • For steel, cast iron and non-ferrous metals • Double sided, thicker inserts for high stability and deeper cutting depths • Inserts with four cutting edges 	B129
EMP13		 ANGX1105 ANGX1506	90°	✓	✓	✓	✓			<ul style="list-style-type: none"> • Diameter range Ø25 – 40 mm • For steel, cast iron and non-ferrous metals • Double sided, thicker inserts for high stability and deeper cutting depths • Inserts with four cutting edges 	B131

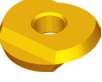
Profile milling

BMR01		 ZDET08T2 & SPMT0603 ZDET1103 & SPMT0603 ZDET13T2 & SDMT0903 ZPNT2204 & SPMT1204		✓	✓	✓				<ul style="list-style-type: none"> • Diameter range Ø20 – 63 mm • For steel, stainless steel and cast iron • Very suitable for roughing of big moulds • Inserts with three cutting edges 	B133
BMR02		 ROHX1203 ROHX1604 ROHX2005		✓	✓	✓				<ul style="list-style-type: none"> • Diameter range Ø12 – 20 mm • For steel, stainless steel and cast iron • Very suitable for finishing in mould and die industry • Inserts with two cutting edges 	B136
BMR03		 XPHT16 XPHT20 XPHT25 XPHT30 XPHT32 XPHT40		✓	✓	✓				<ul style="list-style-type: none"> • Diameter range Ø16 – 40 mm • For steel and cast iron • Very suitable for roughing in mould and die industry • Tool with high stability 	B138

✓ Very suitable ✓ Suitable

A

Turning

B

Milling

C

Drilling









D

Technical Information

E

Index

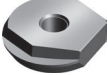
Profile milling

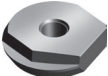
Series	Milling body	Inserts	Kr	Application						Features	Page
				P	M	K	N	S	H		
BMR03		 XPHT16 XPHT20 XPHT25 XPHT30 XPHT32 XPHT40 XPHT50		✓	✓	✓				<ul style="list-style-type: none"> • Diameter range Ø16 – 40 mm • For steel and cast iron • Very suitable for roughing in mould and die industry • Tool with high stability 	B140
BMR03		 XPHT20 XPHT25 XPHT30 XPHT32 XPHT40 XPHT50		✓	✓	✓				<ul style="list-style-type: none"> • Diameter range Ø16 – 40 mm • For steel and cast iron • Very suitable for roughing in mould and die industry • Tool with high stability 	B142
BMR03		 XPHT40 XPHT50		✓	✓	✓				<ul style="list-style-type: none"> • Diameter range Ø16 – 40 mm • For steel and cast iron • Very suitable for roughing in mould and die industry • Tool with high stability 	B144
BMR04		 ZOHX12 ZOHX16 ZOHX20 ZOHX25 ZOHX30 ZOHX32		✓	✓	✓				<ul style="list-style-type: none"> • Diameter range Ø12 – 32 mm • For steel, stainless steel and cast iron • Very suitable for finishing in mould and die industry • Inserts with two cutting edges 	B146
BMR04		 ZOHX12 ZOHX16 ZOHX20 ZOHX25 ZOHX30 ZOHX32		✓	✓	✓				<ul style="list-style-type: none"> • Diameter range Ø12 – 32 mm • For steel, stainless steel and cast iron • Very suitable for finishing in mould and die industry • Inserts with two cutting edges 	B148

✓ Very suitable ✓ Suitable

A

Turning

B

Milling

C

Drilling











D

Technical Information

E

Index

Slot milling

Series	Milling body	Inserts	Kr	Application						Features	Page
				P	M	K	N	S	H		
SMP01		 XSEQ1202 XSEQ1203 XSEQ12T3 XSEQ1204 XSEQ12T4	90°	✓	✓	✓				<ul style="list-style-type: none"> • Diameter range Ø100 – 250 mm • For steel, stainless steel and cast iron • Bore with keyway • Groove widths 4, 5, 6, 7, 8 mm 	B151
SMP01		 XSEQ1202 XSEQ1203 XSEQ12T3 XSEQ1204 XSEQ12T4	90°	✓	✓	✓				<ul style="list-style-type: none"> • Diameter range Ø63 – 160 mm • For steel, stainless steel and cast iron • Groove widths 4, 5, 6, 7, 8 mm 	B153
SMP03		 MPHT0603 MPHT0803 MPHT1204	90°	✓	✓	✓				<ul style="list-style-type: none"> • Diameter range Ø80 – 200 mm • For steel, stainless steel and cast iron • Bore with keyway • Groove widths 8, 10, 12, 16, 18, 20 mm 	B155
SMP03		 MPHT0603 MPHT0803 MPHT1204	90°	✓	✓	✓				<ul style="list-style-type: none"> • Diameter range Ø80 – 200 mm • For steel, stainless steel and cast iron • Groove widths 8, 10, 12, 16, 18, 20 mm 	B157
SMP05		 QC16L QC22L	90°	✓	✓	✓				<ul style="list-style-type: none"> • Diameter range Ø25 – 44 mm • For steel, stainless steel and cast iron • Groove widths range 1,1 – 4,8 mm 	B159

✓ Very suitable ✓ Suitable

A

Turning

B

Milling

C

Drilling









D

Technical Information



E

Index

High-feed milling



Series	Milling body	Inserts	Kr	Application						Features	Page
				P	M	K	N	S	H		
XMR01		 SDMT06T2 SDMT09T3 SDMT1204 SDMT1505	15°	✓	✓	✓				<ul style="list-style-type: none"> • Diameter range Ø20 – 40 mm • For steel, stainless steel and cast iron • Inserts with four cutting edges • Ramping possible • Double clamping system for inserts 	B163
XMR01		 SDMT06T2 SDMT09T3 SDMT1204 SDMT1505	15°	✓	✓	✓				<ul style="list-style-type: none"> • Diameter range Ø40 – 125 mm • For steel, stainless steel and cast iron • Inserts with four cutting edges • Ramping possible • Double clamping system for inserts 	B165
XMR01		 WPGT0503 WPGT0604	11°- 22°	✓	✓	✓				<ul style="list-style-type: none"> • Diameter range Ø20 – 40 mm • For steel, stainless steel and cast iron • Inserts with three cutting edges • Ramping possible • Double clamping system for inserts 	B168
XMR01		 WPGT0604 WPGT0806 WPGT0907	11°- 22°	✓	✓	✓				<ul style="list-style-type: none"> • Diameter range Ø42 – 160 mm • For steel, stainless steel and cast iron • Inserts with three cutting edges • Ramping possible • Double clamping system for inserts 	B170

Bore milling





XMP01		 CNE12	90°	✓	✓	✓				<ul style="list-style-type: none"> • Diameter range Ø80 – 400 mm • For steel, stainless steel and cast iron • Also for face and square shoulder milling 	B173
-------	---	--	-----	---	---	---	--	--	--	--	------

✓ Very suitable ✓ Suitable

T-slot milling

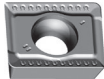
Series	Milling body	Inserts	Kr	Application						Features	Page
				P	M	K	N	S	H		
TMP01		 MPHT0603 MPHT0803 MPHT1204	90°	✓	✓	✓				<ul style="list-style-type: none"> • Diameter range Ø21 – 60 mm • For cast iron • Groove widths 9, 11, 14, 18, 22, 28 mm 	B175

Helical milling

HMP01		 APKT1504 & SPMT1204	90°	✓	✓	✓				<ul style="list-style-type: none"> • Diameter range Ø40 – 50 mm • For steel and cast iron • Weldon shank 	B177
HMP01		 APKT1504 & SPMT1204	90°	✓	✓	✓				<ul style="list-style-type: none"> • Diameter range Ø50 – 80 mm • For steel and cast iron • With JT coupling 	B179
HMP01-EC		 APKT1504 & SPMT1204	90°	✓	✓	✓				<ul style="list-style-type: none"> • Diameter range Ø50 – 80 mm • For steel and cast iron • With JT coupling • With indexable head 	B181

✓ Very suitable ✓ Suitable

A

Turning

B

Milling

C

Drilling













D

Technical
Information

E

Index

Chamfer milling

Series	Milling body	Inserts	Kr	Application						Features	Page
				P	M	K	N	S	H		
CMZ01		 SPMT1204	30°	✓	✓	✓				<ul style="list-style-type: none"> • Diameter range Ø12 – 32 mm • For steel, stainless steel and cast iron • Chamfer milling cutter 30° 	B185
CMZ01		 SPMT1204	30°	✓	✓	✓				<ul style="list-style-type: none"> • Diameter range Ø12 – 32 mm • For steel, stainless steel and cast iron • Chamfer milling cutter 30° 	B183
CMA01		 SPMT1204	45°	✓	✓	✓				<ul style="list-style-type: none"> • Diameter range Ø12 – 32 mm • For steel, stainless steel and cast iron • Chamfer milling cutter 45° • Weldon shank 	B187
CMA01		 SPMT1204	45°	✓	✓	✓				<ul style="list-style-type: none"> • Diameter range Ø12 – 32 mm • For steel, stainless steel and cast iron • Chamfer milling cutter 45° • Weldon shank 	B189
CMD01		 SPMT1204	60°	✓	✓	✓				<ul style="list-style-type: none"> • Diameter range Ø12 – 32 mm • For steel, stainless steel and cast iron • Chamfer milling cutter 60° • Weldon shank 	B191
CMD01		 SPMT1204	60°	✓	✓	✓				<ul style="list-style-type: none"> • Diameter range Ø12 – 32 mm • For steel, stainless steel and cast iron • Chamfer milling cutter 60° • Weldon shank 	B193

✓ Very suitable ✓ Suitable

A

Turning

B

Milling

C

Drilling











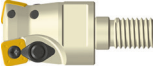

D

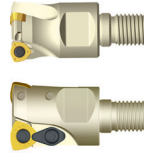
Technical Information

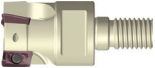
E

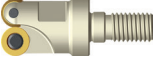
Index

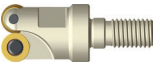
Indexable heads - QCH series

Series	Milling body	Inserts	Kr	Application						Features	Page
				P	M	K	N	S	H		
QCH-XPHT		 XPHT16 XPHT20 XPHT25 XPHT30 XPHT32		✓	✓	✓				<ul style="list-style-type: none"> Diameter range Ø16 – 32 mm For steel and cast iron Very suitable for roughing in mould and die industry 	B195
QCH-SDMT		 SDMT06T2 SDMT09T3 SDMT1204	15°	✓	✓	✓				<ul style="list-style-type: none"> Diameter range Ø20 – 40 mm For steel, stainless steel and cast iron Inserts with four cutting edges Ramping possible Double clamping system for inserts 	B197
QCH-WPGT		 WPGT0503 WPGT0604 WPGT0806	11°- 22°	✓	✓	✓				<ul style="list-style-type: none"> Diameter range Ø16 – 42 mm For steel, stainless steel and cast iron Inserts with three cutting edges Ramping possible Double clamping system for inserts 	B199
QCH-APKT		 APKT11T3 APKT1604	90°	✓	✓	✓	✓	✓		<ul style="list-style-type: none"> Diameter range Ø16–40 mm For steel, stainless steel, cast iron, non-ferrous metals and heat-resistant alloys For square-shoulder, slot and plunge milling Milling cutter with positive, soft cutting geometry INSERTs with two cutting edges For metric ISO threads according to DIN standard only 	B201
QCH-RD		 RDKW0702 RDKW10T3 RDKW1605		✓	✓	✓			✓	<ul style="list-style-type: none"> Diameter range Ø15 – 42 mm For steel, stainless steel and cast iron Screw clamping Mould and die industry For two different thicknesses of inserts 	B204
QCH-RD		 RDKW0702 RDKW1003 RDKW12T3 RDKW1604		✓	✓	✓			✓	<ul style="list-style-type: none"> Diameter range Ø15 – 42 mm For steel, stainless steel and cast iron Screw clamping Mould and die industry For two different thicknesses of inserts 	B206

✓ Very suitable ✓ Suitable

A

Turning

B

Milling

C

Drilling







D

Technical Information

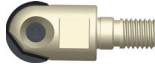
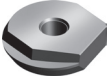
E

Index

QCH series

Series	Milling body	Inserts	Kr	Application						Features	Page
				P	M	K	N	S	H		
QCH-ZOHX		 ZOHX16 ZOHX20 ZOHX25 ZOHX30 ZOHX32		✓	✓	✓				<ul style="list-style-type: none"> • Diameter range Ø16 – 32 mm • For steel, stainless steel and cast iron • Very suitable for finishing in mould and die industry • Inserts with two cutting edges 	B208
QCH-SDMT-Q		 SDMT09T3		✓	✓	✓				<ul style="list-style-type: none"> • Diameter range Ø16–40 mm
 • For steel, stainless steel, cast iron, non-ferrous metals and heat-resistant alloys
 • For square-shoulder, slot and plunge milling
 • Milling cutter with positive, soft cutting geometry
 • Inserts with two cutting edges
 • Only for Q-thread according to ZCC-CT factory standard 	B210
QCH-APKT-Q		 APKT11T3	90°	✓	✓	✓				<ul style="list-style-type: none"> • Diameter range Ø20 – 40 mm
 • For steel, stainless steel and cast iron
 • Inserts with four cutting edges
 • Ramping possible
 • Double clamping system for inserts
 • Only for Q-thread according to ZCC-CT factory standard 	B212
QCH-SPGT-Q		 SPGT0502		✓	✓	✓				<ul style="list-style-type: none"> • Diameter range Ø16 – 20 mm
 • For steel, stainless steel and cast iron
 • For deburring and chamfer milling
 • Soft cutting milling cutter with large, positive cutting edge geometry
 • Inserts with four cutting edges
 • Only for Q-thread according to ZCC-CT factory standard 	B214

A

Turning

B

Milling

C

Drilling

D

Technical Information



E

Index

Chip breaker overview

	Finishing	Medium machining	Roughing	
A Turning	DF	DM	DR	
	APF	APM	-	
	PF	PM	PR	
	GF	GM	GR	
	GL	GM	GH	
	-	HGR	-	
	-	-	ZR	
	-	XR	-	
	-	MM	-	
	MO-2	MO-1	MO-3	
B Milling	EF	EM	-	
	APF	APM	-	
	DF	DM	-	
	PF	PM	PR	
	GF	GM	GR	
	GL	GM	GH	
	-	HGR	-	
	E	E	-	
	-	-	ZR	
	-	XR	-	
C Drilling	-	MM	-	
	CF	CM	CR	
	DF	DM	DR	
	EDFR	DER	DER	
	PF	PM	PR	
	GF	GM	GR	
	GL	GM	GH	
	-	-	ZR	
	-	XR	-	
	MO-2	MO-1	MO-3	
D Technical Information	EF	EM	-	
	NM	NM	-	
	LH	LH	LH	
	ALH	ALH	ALH	
	E Index			

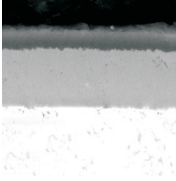
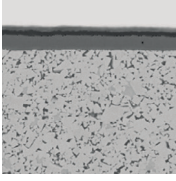
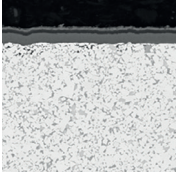
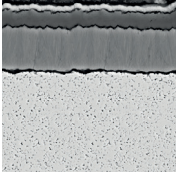
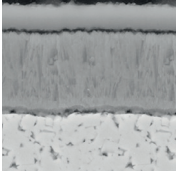
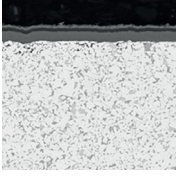
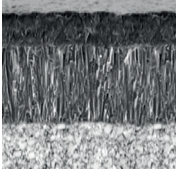
Coated cemented carbide CVD

Grade	ISO	Micro structure	Grade description
YBC302	P20 - P35		CVD coated P20-P35 carbide grade for medium operation to roughing of steel at higher cutting speed. Optimal performance of wear resistance and toughness for a wide application field.
YBC301	P20 - P35		CVD coated P20-P35 carbide grade for medium operation to roughing of steel at lower cutting speed.
YBC401	P30 - P50 M30 - M40		CVD coated P30-P50/M30-M40 carbide grade for roughing operation of steel at lower cutting speed and unstable condition.
YBM251	P20 - P30 M15 - M35		CVD coated P20-P30/M15-M35 carbide grade for medium to roughing operation in stainless steel and steel with wide application field. Good wear resistance and capability against plastic deformation at normal cutting speed.
YBM253	M15 - M35		CVD coated M15-M35 carbide grade for medium to roughing operation in stainless steel with wide application field. High wear resistance and capability against plastic deformation at higher cutting speed.
YBM351	P25 - P40 M20 - M40		CVD coated P25-P40/M25-M40 carbide grade for roughing operation in stainless steel and steel. Good wear resistance and edge stability at normal cutting speed.
YBD152	K10 - K25		CVD coated K10-K25 carbide substrate. Optimized for medium to roughing operation of cast iron. Good wear resistance and toughness at higher cutting speed.
YBD252	K20 - K35		CVD coated K20-K35 carbide substrate. Optimized for medium to roughing operation of cast iron and Steel. Good wear resistance and toughness at higher cutting speed.

A

Turning

B

Milling

C

Drilling

DTechnical
Information**E**

Index

Coated cemented carbide PVD

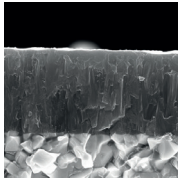
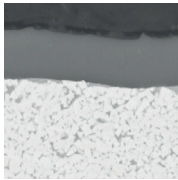
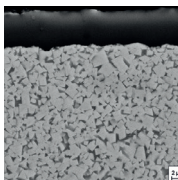
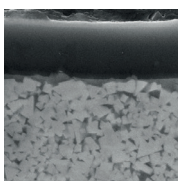
Grade	ISO	Micro structure	Grade description
A Turning	YBG101	N05–N20	 <p>PVD coated N05–N20 carbide substrate for finishing to semi-finishing in aluminium materials. Coating only on the top face, in combination with the aluminium chip breakers, prevents built-up edges and gives a smooth cut.</p>
B Milling	YBG202	P10 - P30 M10-M25	 <p>PVD coated P10–P30/M10–M25 carbide substrate for finishing to medium application of stainless steel and steel (milling). Good wear resistance in a wide application field.</p>
D Technical Information	YBS203	S15 – S25	 <p>Turning and milling grades for processing heat-resistant materials. A special carbon substrate and the latest PVD coating technology enable a very good wear behaviour, high fracture toughness and high thermal stability.</p>
YBG302	P15 - P30 M25 - M40	 <p>PVD multilayer coated P10–P30/M10–M25 carbide substrate for finishing to medium machining of stainless steel, super alloys and steel (grooving/milling). Optimised coating stability for higher wear resistance and thermal stability in a wide range of applications.</p>	
			YBG302

Coated cemented carbide PVD

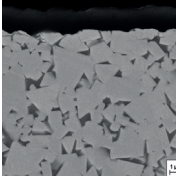
Grade	ISO	Micro structure	Grade description
YBS303	S25 - S35		Milling grade for machining titanium alloys. A tough carbide substrate and the latest PVD coating technology with increased impact resistance and high thermal stability.

Cermet

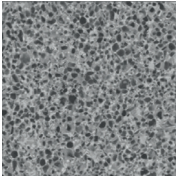
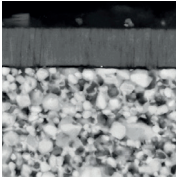
Grade	ISO	Micro structure	Grade description
YNG151	P05 - P15		Uncoated P05-P15 cermet grade for fine finishing operation of steel and stainless steel. Good resistance against plastic deformation for good surface finishing.
YNG151C	P05 - P15		PVD coated P05-P15 cermet grade for fine finishing operation of steel and stainless steel. Good wear resistance and capability against plastic deformation for good surface roughness.

Uncoated cemented carbide

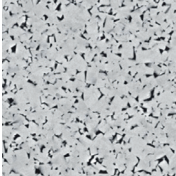
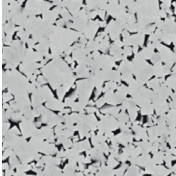
Grade	ISO	Micro structure	Grade description
YD101	N05 - N25 K05 - K20		Uncoated K05-K20/N05-N20 carbide substrate for fine to medium application in aluminum and other material.
YD201	K10 - K30 N10 - N30		Uncoated K10-K30/N10-N30 carbide substrate for medium application in aluminum and other material.

A

Turning

B

Milling

C

Drilling

DTechnical
Information**E**

Index

Application fields of grades – indexable milling

	ISO	HC ¹ (CVD)	HC ¹ (PVD)	HT	HC ²	HW	PCBN/PCD
P	P01		YBG102		YNG151C		
	P10		YBG202	YNG151			
	P20	YBC301	YBG205				
	P30	YBC401	YBG302			YC305	
	P40	YBM351	YB9320				
M	M01		YBG102		YNG151C		
	M10	YBM251	YBG202	YNG151			
	M20	YBM253	YBG205				
	M30	YBM351	YBG302			YC305	
	M40	YBC401	YB9320				
K	K01		YBG102				
	K10	YBD152	YBG152				
	K20	YBD252	YBG202			YD201	
	K30						
	K40						
N	N01					YD051	
	N10		YBG101			YD101	
	N20		YBG202				YD201
	N30						
S	S01		YBG102				
	S10		YBG202				
	S20		YBG205				
	S30		YBS203				
			YBS303				
H	H01		YBG102				
	H10						
	H20						
	H30						

P	Steel
M	Stainless steel
K	Cast iron

N	Non-ferrous metals
S	Heat-resistant alloys
H	Hardened materials

HC ¹	Coated carbide
HT	Uncoated cermet
HC ²	Coated carbide
HW	Uncoated carbide

Notes

Dotted lines for notes

A

Turning

B

Milling

C

Drilling

D

Technical
Information

E





Index

FM A 12 050 – A22 O – N 06 – 04 (L) (C)

1 2 3 4 5 6 7 8 9 10 11

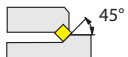
Type	
Code	Description
BM	Profile milling
CM	Chamfer milling
EM	Square shoulder milling
FM	Face milling
HM	Helical milling
SM	Slot milling
TM	T-slot milling
XM	Special

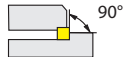
1

Entering angle	
A	
E	
D	
P	
R	

2

Serial number

3

Nominal diameter [mm]	
Code	Description
025	25
050	50
160	160
315	315
...	

4

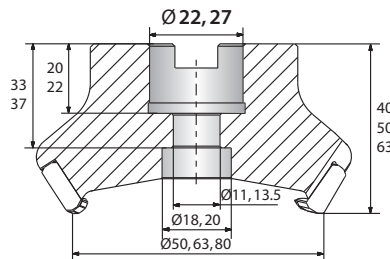
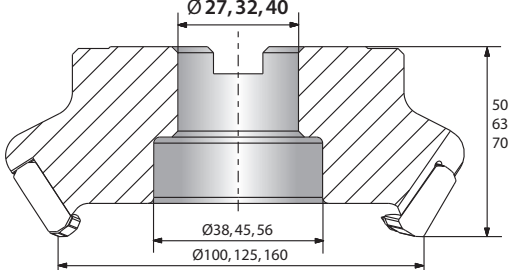
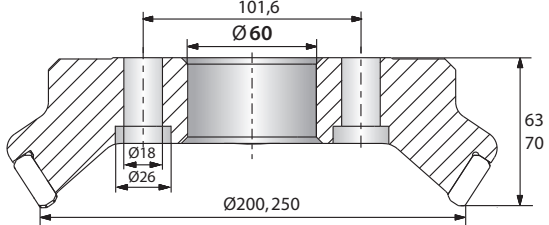
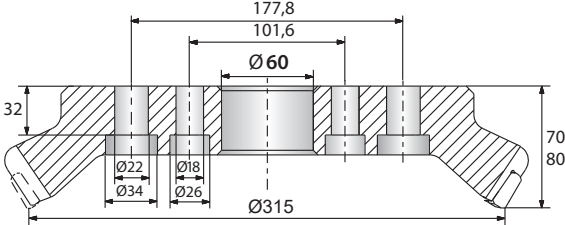
Type and size of tool holders			
Code	Type	Code	Type
A	<p>Nominal diameter $\varnothing 50 - 80$ mm</p> 	B	<p>Nominal diameter $\varnothing 100 - 160$ mm</p> 
C	<p>Nominal diameter $\varnothing 200 - 250$ mm</p> 	D	<p>Nominal diameter $\varnothing 315$ mm</p> 
G	Straight shank	XP	Weldon shank
K	Bore with keyway		

5

With respect to mounting please adhere to the information provided by the tool holder manufacturer.

Insert shape	
A	C
H	L
M	O
P	R
S	T
W	X Special
Z Special	

6

Clearance angle	
B	C
D	E
F	N
P	

7

Cutting edge length l [mm]	
Insert shape	
A	C, M
H, O, P	L
R	S
T	W

8

Number of teeth

9

Cutting direction	
Code	Description
L	Left

10

With inner cooling

11



Tools with B coupling and inner coolant supply require the following spare parts:



Coolant clamp screw



Coolant shower plate



Spare parts (B coupling with inner coolant supply)

		B27	B32	B40	B40
	Ø	80	100	125	160
	Coolant clamp screw	LDB27C	LDB32C	LDB40C	LDB40C
	Coolant shower plate	B27-002-CP	B32-002-CP	B40-002-CP	B40-003-CP

When purchasing tools with inner coolant supply and B coupling these spare parts are included in delivery.

A

Turning

B

Milling

C

Drilling

D

Technical Information

E

Index

S P K N 12 04 ED T21K R – DM

1 2 3 4 5 6 7 8 9 10

A

Turning

B

Milling

C











Drilling







D

Technical Information

E

Index

Insert shape	
A 	C 
H 	L 
M 	O 
P 	R 
S 	T 
W 	X Special
Z Special	















Clearance angle	
B 	C 
D 	E 
F 	N 
P 	









Tolerance class			
			
Code	I.C [mm]	m [mm]	S [mm]
A	±0,025	±0,005	±0,025
C	±0,025	±0,013	±0,025
E	±0,025	±0,025	±0,025
F	±0,013	±0,005	±0,025
G	±0,025	±0,025	±0,130
H	±0,013	±0,013	±0,025
J	±0,05-0,13	±0,005	±0,025
K	±0,05-0,13	±0,013	±0,025
L	±0,05-0,13	±0,025	±0,025
M	±0,05-0,13	±0,08-0,18	±0,130
N	±0,05-0,13	±0,08-0,18	±0,025
U	±0,08-0,25	±0,13-0,38	±0,130

1

2

3

Fastening features (metric)	
Insert shape	
A 	B 
C 	F 
G 	H 
J 	M 
N 	Q 
R 	T 
U 	W 
X Special	

Cutting edge length l [mm]	
Insert shape	
	
A	C, M
	
H, O, P	L
	
R	S
	
T	W

4

5

Insert thickness S [mm]			
Code	S	Code	S
00	0,79	05	5,56
T0	0,99	T5	5,95
01	1,59	06	6,35
T1	1,98	T6	6,75
02	2,38	07	7,94
T2	2,58	09	9,52
03	3,18	T9	9,72
T3	3,97	11	11,11
04	4,76	12	12,70
T4	4,96		

6

Angle			
Code	Kr	Code	an
A	45°	A	3°
D	60°	B	5°
E	75°	C	7°
F	85°	D	15°
P	90°	E	20°
Z	Special	F	25°
		G	30°
		N	0°
		P	11°
		Z	Special

7

Chamfer							
Code	Type	Code	Angle	Code	Width [mm]	Code	Position
F		0	5°	0	0,10	K	
E		1	10°	1	0,15	P	
T		2	15°	2	0,20	W	
S		3	20°	3	0,25	-	
		4	25°	4	0,30		
		5	30°	5	0,35		
				6	0,40		
				7	0,45		

8

Cutting direction	
Code	Description
R	Right
L	Left
N	Right and left

9

Chip breaker overview
(on page B20)

10

A

Turning

B

Milling

C

Drilling

D

Technical Information

E

Index

SM P 03 – 160 × 16 – K 40 – M P 12 – 12 L

1 2 3 4 5 6 7 8 9 10 11 12

A

Turning

Type	
Code	Description
SM	Slot milling cutter

1

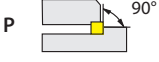
Entering angle

2

B

Milling

Serial number

3

Nominal diameter [mm]

4

Cutting width [mm]

5

C

Drilling

Tool holder type			
Code	Description	Code	Description
A	A type	B	B type
C	C type	D	D type
K	With feather key		



6

Diameter of mounting hole [mm]



7

D

Technical Information

Insert shape	
M 	S 

8

Clearance angle	
N 	P 

9

Insert size [mm]

10

Number of teeth

11

Cutting direction	
Code	Description
R	Right
L	Left

12

E

Index

QCH – 35 – SDMT 09 – Q 18 – 03

1 2 3 4 5 6 7

Series [mm]	
Code	Description
QCH	Indexable head system



Nominal diameter [mm]	
Code	Description
16	16
20	20
25	25
35	35
...	

Insert shape

1

2

3

Cutting edge length l [mm]	
A	
R	
S	

Thread type	
Code	Description
M	Metric
Q	Q thread

Thread size [mm]	
Code	Description
8	8
10	10
12	12
14	14
...	

4

5

6

Number of teeth

7

A

Turning

B

Milling

C

Drilling

D

Technical Information

E

Index

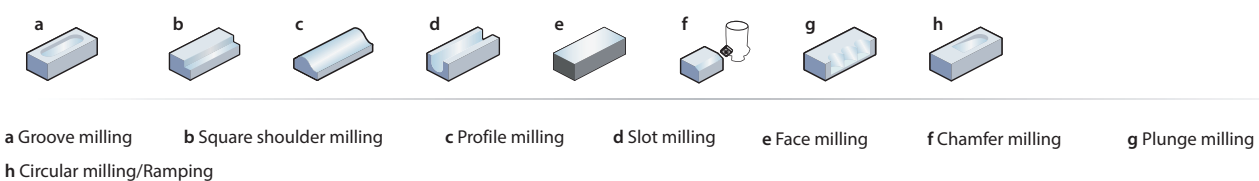

A

G 25 – QCH – Q 12 – 250 C – (ZJ) (115)

1

2

3

4

5

6

7

8

9

Turning

Clamping form	
Code	Description
G	Cylindrical
XP	Weldon

Clamping diameter [mm]	
Code	Description
12	12
16	16
20	20
25	25
32	32

Series [mm]	
Code	Description
QCH	Indexable head system

1

2

3

B

Milling

Thread type	
Code	Description
M	Metric
Q	Q thread

Thread size [mm]	
Code	Description
8	8
10	10
12	12
14	14
...	

Total length [mm]	
Code	Description
85	85
150	150
200	200
...	

4

5

6

C

Drilling

Material	
Code	Description
C	Solid carbide
S	Steel

Shank	
Code	Description
ZJ	Conical
-	Cylindrically stepped

Taper length [mm]	
Code	Description
90	90
115	115
...	

7

8

9

D

Technical Information

E

Index

Face milling

FMA01 Kr: 45°

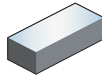

Fine pitch

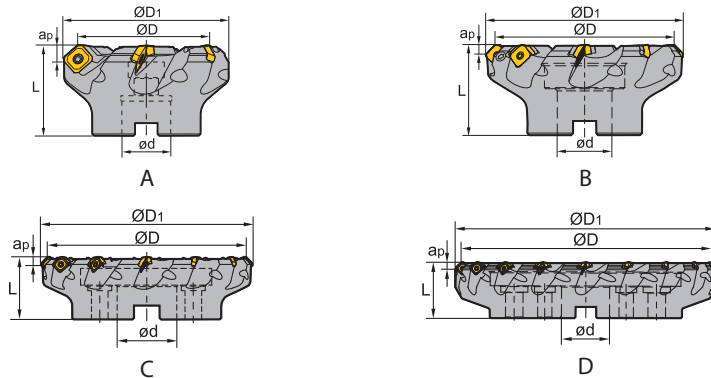

Article	*	Stock		Dimensions [mm]					Teeth	Coupling	kg	Inserts
		R	L	ØD	ØD ₁	ød	L	a _{p max}				
FMA01-050-A22-SE12-04	● ○	50	61	22	40	6	4	A	0.3	SEET12T3		
FMA01-050-A22-SE12-04C	* ● ○	50	61	22	40	6	4	A	0.3			
FMA01-063-A22-SE12-05	● ○	63	74	22	40	6	5	A	0.5			
FMA01-063-A22-SE12-05C	* ● ○	63	74	22	40	6	6	A	1.2			
FMA01-080-A27-SE12-06	● ●	80	91	27	50	6	6	A	1.2			
FMA01-080-A27-SE12-06C	* ● ○	80	91	27	50	6	6	A	1.2			
FMA01-100-B32-SE12-07	● ○	100	107	32	50	6	7	B	1.2			
FMA01-100-B32-SE12-07C	* ○ ○	100	107	32	50	6	7	B	1.2			
FMA01-125-B40-SE12-08	● ●	125	136	40	63	6	8	B	2.6			
FMA01-125-B40-SE12-08C	* ○ ○	125	136	40	63	6	8	B	2.6			
FMA01-160-B40-SE12-10	● ●	160	170	40	63	6	10	B	4.3			
FMA01-160-B40-SE12-10C	* ○ ○	160	170	40	63	6	10	B	4.3			
FMA01-200-C60-SE12-12	● ○	200	210	60	63	6	12	C	7.6			
FMA01-250-C60-SE12-14	● ○	250	260	60	63	6	14	C	13.5			
FMA01-315-D60-SE12-18	● ○	315	325	60	70	6	18	D	20.8			
FMA01-100-B32-SE18-04	○ ○	100	120	32	63	10	4	B	1.2		SEET18T6	
FMA01-125-B40-SE18-05	○ ○	125	145	40	63	10	5	B	2.6			
FMA01-160-C40-SE18-06	○ ○	160	180	40	63	10	6	C	4.3			
FMA01-200-C60-SE18-08	● ○	200	220	60	63	10	8	C	7.6			
FMA01-250-C60-SE18-10	● ○	250	270	60	63	10	10	C	13.5			
FMA01-315-D60-SE18-12	○ ○	315	335	60	80	10	12	D	20.8			

● Ex stock ○ On demand

* With internal cooling

System code > B26

Grade selection > B24

Technical info > B527

Cutting data > B230



A

Turning

B

Milling

C

Drilling

D

Technical Information

E

Index

A

Turning

B

Milling

C

Drilling

D

Technical Information

E

Index

Spare parts				
Insert	SEET12T3	SEET12T3	SEET18T6	
ØD	50-100	125 - 315	100- 315	
	Screw (insert)	I60M3.5×10 (2.7 Nm)	I60M3.5×12 (2.7 Nm)	I60M5×17 (6.7 Nm)
	Screw (shim)		SM5×7XA	SM8×9XA
	Shim		S13BS	S18BS
	Wrench (shim)		WH35L	WH50L
	Wrench (insert)	WT15IS	WT15IS	
	Wrench (insert)			WT20IT

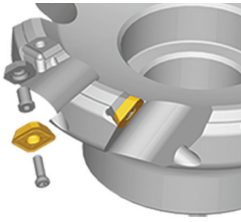

Milling inserts

- Ideal machining conditions
- Normal machining conditions
- Unfavourable machining conditions

SEET	L	I.C	S	d
12 T3	17.82	13.4	3.97	4.1

SE** milling insert			HC ¹ (CVD)						HC ¹ (PVD)						HT	HC ²	HW															
	P	M	K	N	S	H																										
	ISO							R	bs	YBC302	YBC301	YBC401	YBM253	YBM251	YBM351	YBD152	YBD252	YBG101	YBG102	YBG202	YBG212	YBS203	YBG205	YB9320	YBG302	YBS303	YBG252	YNG151	YNG151C	YD101	YD201	
		SEET12T3-W		9.46																												

● Ex stock ○ On demand

HC¹ Coated carbide
 HT Uncoated cermet
 HC² Coated cermet
 HW Uncoated carbide

System code > B26

Grade selection > B24

Technical info > B527

Cutting data > B230

- Ideal machining conditions
- ⊗ Normal machining conditions
- ⊗ Unfavourable machining conditions

SEET	L	I.C	S	d
12 T3	13.4	13.4	3.97	4.1
18 T6	18	18	6.1	5.5

Milling inserts

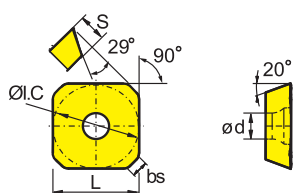

SE** milling insert			HC ¹ (CVD)						HC ¹ (PVD)						HT	HC ²	HW								
		P	M	K	N	S	H																		
ISO		bs	YBC302	YBC301	YBC401	YBM253	YBM251	YBM351	YBD152	YBD252	YBG101	YBG102	YBG202	YBG212	YBS203	YBG205	YB9320	YBG302	YBS303	YBG252	YNG151	YNG151C	YD101	YD201	
	SEET12T3-CF	2.55							○		●														
	SEET12T3-CM	2.55							●		●														
	SEET12T3-CR	2.55							● ●			○													
	SEET12T3-DF	2.55	● ●			○ ●						○						○			○				
	SEET12T3-DM	2.55	● ● ● ●			○ ●						○				● ●									
	SEET18T6-DM	2.29	●			●																			
	SEET12T3-DR	2.55	● ●			●		○				○						○							
	SEET12T3-EF	2.55										○						●							
	SEET12T3-EM	2.55				○ ●						○						●							
	SEET12T3-LH	2.55									○													● ●	

● Ex stock ○ On demand

HC¹ Coated carbide
 HT Uncoated cermet
 HC² Coated cermet
 HW Uncoated carbide

A Turning
B Milling
C Drilling
D Technical Information
E Index



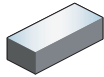

Face milling

FMA02 Kr: 45°



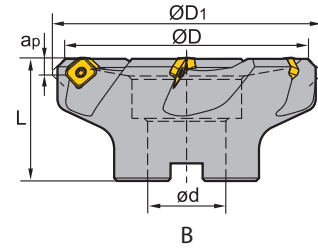
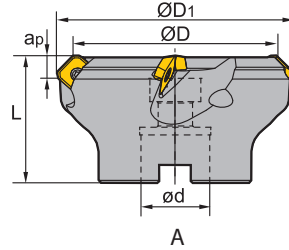

Coarse and differential pitch



Article	*	Stock	Dimensions [mm]					Teeth	Coupling	kg	Inserts 
			ØD	ØD ₁	ød	L	a _{p max}				
FMA02-050-A22-SE12-03		●	50	61	22	40	6	3	A	0.4	SEET12T3
FMA02-063-A22-SE12-04		●	63	74	22	40	6	4	A	0.6	
FMA02-080-A27-SE12-04		●	80	91	27	50	6	4	A	1.3	
FMA02-100-B32-SE12-05		●	100	107	32	50	6	5	B	1.3	
FMA02-125-B40-SE12-06		○	125	131	40	63	6	6	B	2.6	

● Ex stock ○ On demand

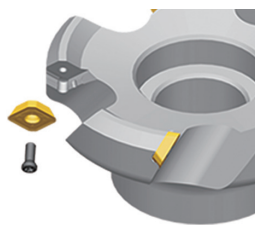
* With internal cooling

Spare parts			
	Insert	SEET12T3	
	ØD	50-125	
	Screw (insert)	I60M3.5×10 (2.7Nm)	
	Wrench (insert)	WT15IS	

System code > B26

Grade selection > B24

Technical info > B527

Cutting data > B230

A

Turning

B

Milling

C

Drilling

D

Technical Information

E

Index

- Ideal machining conditions
- Normal machining conditions
- Unfavourable machining conditions

SEET	L	I.C	S	d
12 T3	13.4	13.4	3.97	4.1

Milling inserts

SE** milling insert			HC ¹ (CVD)						HC ¹ (PVD)						HT	HC ²	HW									
		P																								
		M																								
		K																								
		N																								
		S																								
		H																								
ISO		bs	YBC302	YBC301	YBC401	YBM253	YBM251	YBM351	YBD152	YBD252	YBG101	YBG102	YBG202	YBG212	YBS203	YBG205	YB9320	YBG302	YBS303	YBG252	YNG151		YNG151C	YD101	YD201	
	SEET12T3-DF	2.55	●	●		○	●						○					○				○				
	SEET12T3-DM	2.55	●	●	●	●	○	●					○			●	●									
	SEET12T3-DR	2.55		●	●			●		○			○					○								
	SEET12T3-EF	2.55											○					●								
	SEET12T3-EM	2.55					○	●					○					●								
	SEET12T3-LH	2.55										○													●	●

● Ex stock ○ On demand

HC¹ Coated carbide
 HT Uncoated cermet
 HC² Coated cermet
 HW Uncoated carbide

System code > B26

Grade selection > B24

Technical info > B527

Cutting data > B230

Face milling

FMA03 Kr: 45°

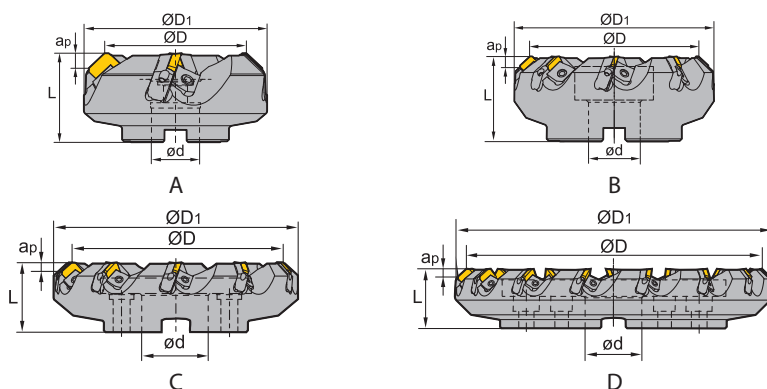
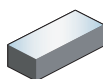

Article	*	Stock		Dimensions [mm]					Teeth	Coupling	kg	Inserts
		R	L	ØD	ØD ₁	ød	L	a _{p max}				
FMA03-080-A27-SE12-04		○	○	80	103	27	50	5.5	4	A	1.8	SEEN1203 SEKN1203 SEKR1203
FMA03-100-B32-SE12-05		○	○	100	122	32	50	5.5	5	B	2.4	
FMA03-125-B40-SE12-06		○	○	125	147	40	63	5.5	6	B	4.4	
FMA03-160-B40-SE12-08		○	○	160	181	40	63	5.5	8	B	6.4	
FMA03-200-C60-SE12-10		○	○	200	221	60	63	5.5	10	C	8.5	
FMA03-250-C60-SE12-12		○	○	250	270	60	63	5.5	12	C	14.1	
FMA03-315-D60-SE12-15		○	○	315	353	60	63	5.5	15	D	22.2	SEKN1504 SEKR1504
FMA03-080-A27-SE15-04		○		80	103	27	50	7.5	4	A	1.7	
FMA03-100-B32-SE15-05		○		100	122	32	50	7.5	5	B	2.3	
FMA03-125-B40-SE15-06		○		125	147	40	63	7.5	6	B	4.2	
FMA03-160-B40-SE15-08		○		160	181	40	63	7.5	8	B	6.1	
FMA03-200-C60-SE15-10		○		200	221	60	63	7.5	10	C	8.3	
FMA03-250-C60-SE15-12		○		250	270	60	63	7.5	12	C	13.6	
FMA03-315-D60-SE15-15		○	○	315	353	60	63	7.5	15	D	21.8	

● Ex stock ○ On demand

* With internal cooling

A

Turning

B

Milling

C

Drilling

D

Technical Information

E

Index

A

Turning

B

Milling

C

Drilling

D

Technical Information

E

Index

Spare parts			
	Insert	SEEN1203 SEKN1203 SEKR1203	SEKN1504 SEKR1504
	ØD	80- 315	80- 315
	Adjustable screw	LOM5×15.1	LOM5×15.1
	Cassette (left)	LSE12L	LSE15L
	Cassette (right)	LSE12R	LSE15R
	Screw (wedge)	DM8×21X (10.2 Nm)	DM8×21X (10.2 Nm)
	Wedge (left)	W01L	W01L
	Wedge (right)	W01R	W01R
	Wrench (locator)	WT20T	WT20T
	Wrench (wedge)	WH40T	WH40T



Milling inserts

- Ideal machining conditions
- Normal machining conditions
- Unfavourable machining conditions

SEKN	L	I.C	S
12 03	12.7	12.7	3.18
15 04	15.875	15.875	4.76

SE** milling insert		HC ¹ (CVD)						HC ¹ (PVD)				HT	HC ²	HW						
ISO	bs	P	M	K	N	S	H	YBG101	YBG102	YBG212	YBS203	YBG205	YB9320	YBG302	YBS303	YBG252	YNG151	YNG151C	YD101	YD201
SEKN1203AFN	1.8	○																		
SEKN1203AFTN	1.8	●	●	●	○	○			○								●	●		○
SEKN1504AFTN	1.6	●	○	●	●								●							
SEKN1504AZ	1.6	○																		○

● Ex stock ○ On demand

HC¹ Coated carbide
 HT Uncoated cermet
 HC² Coated cermet
 HW Uncoated carbide

System code > B26

Grade selection > B24

Technical info > B527

Cutting data > B230

- Ideal machining conditions
- ⊗ Normal machining conditions
- ⊗ Unfavourable machining conditions

SEEN	L	I.C	S
12 03	12.7	12.7	3.18

Milling inserts

SE** milling insert		HC ¹ (CVD)						HC ¹ (PVD)					HT	HC ²	HW									
	P	⊗	⊗	⊗	⊗	⊗	⊗	⊗	⊗	⊗	⊗	⊗	⊗	⊗										
	M	⊗	⊗	⊗	⊗	⊗	⊗	⊗	⊗	⊗	⊗	⊗	⊗	⊗										
	K							⊗	⊗	⊗	⊗	⊗	⊗	⊗										
	N							⊗	⊗	⊗	⊗	⊗	⊗	⊗	⊗	⊗								
	S							⊗	⊗	⊗	⊗	⊗	⊗	⊗	⊗									
	H																							
ISO	bs	YBC302	YBC301	YBC401	YBM253	YBM251	YBM351	YBD152	YBD252	YBG101	YBG102	YBG202	YBG212	YBS203	YBG205	YB9320	YBG302	YBS303	YBG252	YNG151	YNG151C	YD101	YD201	
	SEEN1203AFTN	1.8																			●			

● Ex stock ○ On demand

HC¹ Coated carbide
 HT Uncoated cermet
 HC² Coated cermet
 HW Uncoated carbide

A

Turning

B

Milling

C

Drilling

D

Technical Information

E

Index

Milling inserts

- Ideal machining conditions
- ⊗ Normal machining conditions
- ⊗ Unfavourable machining conditions

SEKR	L	I.C	S
12 03	12.7	12.7	3.18

SE** milling insert		HC ¹ (CVD)						HC ¹ (PVD)					HT	HC ²	HW									
	P	⊗	⊗	⊗	⊗	⊗	⊗	⊗	⊗	⊗	⊗	⊗	⊗	⊗										
	M	⊗	⊗	⊗	⊗	⊗	⊗	⊗	⊗	⊗	⊗	⊗	⊗	⊗										
	K							⊗	⊗	⊗	⊗	⊗	⊗	⊗										
	N							⊗	⊗	⊗	⊗	⊗	⊗	⊗	⊗	⊗								
	S							⊗	⊗	⊗	⊗	⊗	⊗	⊗	⊗									
	H																							
ISO	bs	YBC302	YBC301	YBC401	YBM253	YBM251	YBM351	YBD152	YBD252	YBG101	YBG102	YBG202	YBG212	YBS203	YBG205	YB9320	YBG302	YBS303	YBG252	YNG151	YNG151C	YD101	YD201	
	SEKR1203AFN	1.8	●									○												

● Ex stock ○ On demand

HC¹ Coated carbide
 HT Uncoated cermet
 HC² Coated cermet
 HW Uncoated carbide

Face milling

FMA04 Kr: 45°

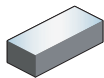

Screw Clamping

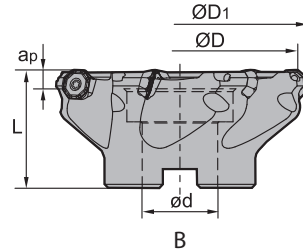
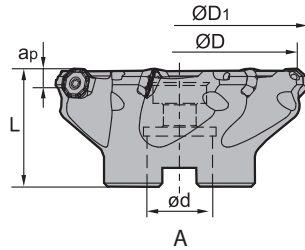

Article	*	Stock		Dimensions [mm]					Teeth	Coupling	kg	Inserts
		R	L	ØD	ØD ₁	ød	L	a _{p max}				
FMA04-050-A22-OF05-04	●			50	56	22	40	3.5	4	A	0.3	OFKT05T3
FMA04-050-A22-OF05-05	●			50	56	22	40	3.5	5	A	0.4	
FMA04-050-A22-OF05-05C	* ○			50	56	22	40	3.5	5	A	0.4	
FMA04-063-A22-OF05-05	●			63	69	22	40	3.5	5	A	0.5	
FMA04-063-A22-OF05-05C	* ○			63	69	22	40	3.5	5	A	0.5	
FMA04-080-A27-OF05-06	● ○			80	86	27	50	3.5	6	A	0.8	
FMA04-080-A27-OF05-06C	* ●			80	86	27	50	3.5	6	A	0.8	
FMA04-100-B32-OF05-07	● ○			100	106	32	50	3.5	7	B	1.2	
FMA04-100-B32-OF05-07C	* ○			100	106	32	50	3.5	7	B	1.2	
FMA04-125-B40-OF05-08	●			125	130	40	63	3.5	8	B	2.7	
FMA04-125-B40-OF05-08C	* ○			125	130	40	63	3.5	8	B	2.7	
FMA04-160-B40-OF05-10	●			160	165	40	63	3.5	10	B	5.1	

● Ex stock ○ On demand

* With internal cooling

Spare parts			
	Insert	OFKT05T3	OFKT05T3
	ØD	50-63	80-160
	Screw (insert)	I60M4×8.4 (3.4 Nm)	I60M4×10 (3.4 Nm)
	Wrench (insert)	WT15IS	WT15IS

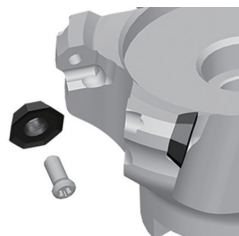



System code > B26

Grade selection > B24





Technical info > B527

Cutting data > B230

-  Ideal machining conditions
-  Normal machining conditions
-  Unfavourable machining conditions

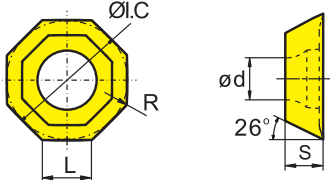
OFKT	L	I.C	S	d
05 T3	5.26	12.7	3.97	4.4

Milling inserts

OF** milling insert			HC ¹ (CVD)						HC ¹ (PVD)					HT	HC ²	HW								
	P																							
	M																							
	K																							
	N																							
	S																							
	H																							
ISO	R	YBC302	YBC301	YBC401	YBM253	YBM251	YBM351	YBD152	YBD252	YBG101	YBG102	YBG202	YBG212	YBS203	YBG205	YB9320	YBG302	YBS303	YBG252	YNG151	YNG151C	YD101	YD201	
	OFKT05T3-DF	0.5								●	○													
	OFKT05T3-DM	0.5				○	●		●	○					●									
	OFKT05T3-LH	0.5																					●	

● Ex stock ○ On demand

HC¹ Coated carbide
 HT Uncoated cermet
 HC² Coated cermet
 HW Uncoated carbide

System code > B26

Grade selection > B24

Technical info > B527

Cutting data > B230



A Turning
B Milling
C Drilling
D Technical Information
E Index

Face milling

FMA04 Kr: 45°

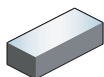

Wedge

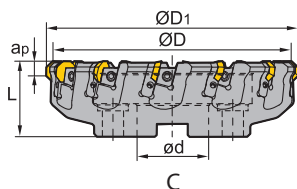

C

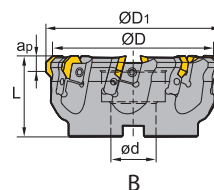

B

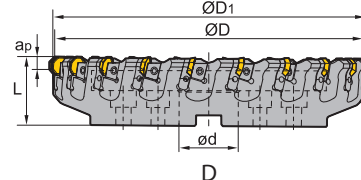

D

Article	*	Stock		Dimensions [mm]					Teeth	Coupling	kg	Inserts
		R	L	ØD	ØD ₁	ød	L	a _{p max}				
FMA04-125-B40-OF07-08	○			125	136	40	63	5	8	B	3.9	OFKR0704
FMA04-160-B40-OF07-10	○			160	171	40	63	5	10	B	5.9	
FMA04-200-C60-OF07-12	○			200	211	60	63	5	12	C	7.6	
FMA04-250-C60-OF07-16	○			250	261	60	63	5	16	C	13.3	
FMA04-315-D60-OF07-20	○	○		315	321	60	63	5	20	D	20.3	

● Ex stock ○ On demand

* With internal cooling

Spare parts

	Insert	OFKR0704
	ØD	125 - 315
	Adjustable screw	LOM5×15.1
	Cassette (left)	LOF07L
	Cassette (right)	LOF07R
	Screw (wedge)	DM8×21X (10.2 Nm)
	Wedge (left)	W02L
	Wedge (right)	W02R
	Wrench (locator)	WT20T
	Wrench (wedge)	WH40T

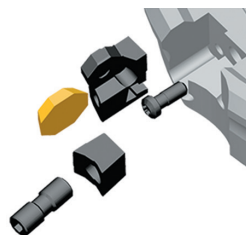

System code > B26

Grade selection > B24

Technical info > B527

Cutting data > B230

- Ideal machining conditions
- ⊗ Normal machining conditions
- ⊗ Unfavourable machining conditions

OFKR	L	I.C	S
07 04	7.45	17.94	4.76

Milling inserts

OF** milling insert			HC ¹ (CVD)						HC ¹ (PVD)						HT	HC ²	HW								
		P	⊗	⊗	⊗	⊗	⊗	⊗	⊗	⊗	⊗	⊗	⊗	⊗	⊗	⊗									
		M	⊗	⊗	⊗	⊗	⊗	⊗	⊗	⊗	⊗	⊗	⊗	⊗	⊗	⊗									
		K								⊗	⊗	⊗	⊗	⊗	⊗	⊗									
		N								⊗	⊗	⊗	⊗	⊗	⊗	⊗									
		S								⊗	⊗	⊗	⊗	⊗	⊗	⊗									
		H																							
ISO		R	YBC302	YBC301	YBC401	YBM253	YBM251	YBM351	YBD152	YBD252	YBG101	YBG102	YBG202	YBG212	YBS203	YBG205	YB9320	YBG302	YBS303	YBG252	YNG151	YNG151C	YD101	YD201	
	OFKR0704-DF	0.8				○						○													
	OFKR0704-DM	0.8	○	○		○	○		○			○						○							
	OFKR0704W-DM	0.8	○						○						○										
	OFKR0704-LH	0.8																						○	

● Ex stock ○ On demand

HC¹ Coated carbide
 HT Uncoated cermet
 HC² Coated cermet
 HW Uncoated carbide

A

Turning

B

Milling

C

Drilling

D

Technical Information

E

Index

System code > B26

Grade selection > B24

Technical info > B527

Cutting data > B230





Face milling

FMA04 Kr: 45°

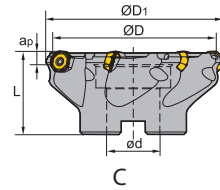
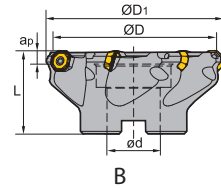
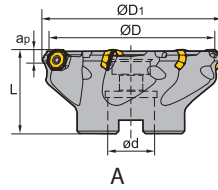

Screw Clamping





Article	*	Stock	Dimensions [mm]					Teeth	kg	Inserts
			ØD	ØD ₁	ød	L	a _{p max}			
FMA04-050-A22-OD06-04C	*	●	50	60	22	40	4	4	0.284	 OD*T0605**
FMA04-063-A22-OD06-05C	*	●	63	73	22	40	4	5	0.409	
FMA04-080-A27-OD06-06C	*	●	80	90	27	50	4	6	1.017	
FMA04-100-A32-OD06-07C	*	●	100	110	32	50	4	7	1.536	
FMA04-125-B40-OD06-08		○	125	135	40	63	4	8	2.931	
FMA04-160-C40-OD06-10		○	160	170	40	63	4	10	3.838	

● Ex stock ○ On demand

* With internal cooling

Spare parts

	Insert	OD*T0605**
	ØD	50-160
	Screw (insert)	I60M5x13 (6.7 Nm)
	Wrench (insert)	WT20IS



System code > B26

Grade selection > B24





Technical info > B527

Cutting data > B230

Milling inserts

-  Ideal machining conditions
-  Normal machining conditions
-  Unfavourable machining conditions

ODHT
06 05
06 05

OD**milling insert		HC ¹ (CVD)						HC ¹ (PVD)						HT	HC ²	HW							
		P																					
		M																					
		K																					
		N																					
		S																					
		H																					
ISO		YBC302	YBC301	YBC401	YBM253	YBM251	YBM351	YBD152	YBD252	YBG101	YBG102	YBG202	YBG212	YBS203	YBG205	YB9320	YBG302	YBS303	YBG252	YNG151	YNG151C	YD101	YD201
	ODHT060508-GH				●			●	●						●								
	ODHT060508-GL				○				○						●								
	ODHT060508-GM	●			●										●								
	ODHT060508-LH																					●	○
	ODMT060512-GM														○								

● Ex stock ○ On demand

HC¹ Coated carbide
 HT Uncoated cermet
 HC² Coated cermet
 HW Uncoated carbide

A Turning
B Milling
C Drilling
D Technical Information
E Index



Face milling

FMA07 Kr: 45°

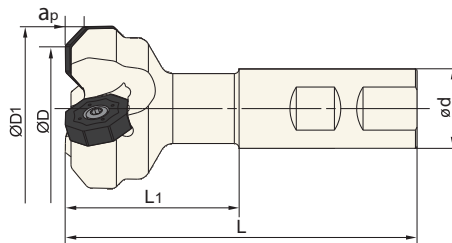
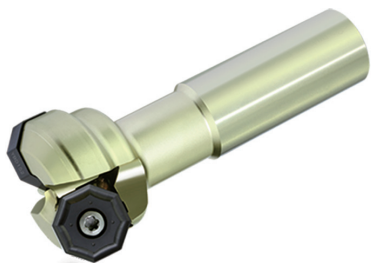
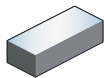

Weldon shank

Article	*	Stock	Dimensions [mm]						Teeth	kg	Inserts
			ØD	ØD ₁	ød	L ₁	L	a _{p max}			
FMA07-025-XP20-ON06-02		○	25	37	20	45	95	4	2	0.2	ONHU0604
FMA07-025-XP20-ON06-02C	*	○	25	37	20	45	95	4	2	0.2	
FMA07-032-XP25-ON06-02C	*	○	32	44	25	55	111	4	2	0.4	
FMA07-040-XP25-ON06-03		○	40	52	25	50	106	4	3	0.4	ONHU08T5
FMA07-032-XP25-ON08-02		○	32	47	25	55	111	5	2	0.4	
FMA07-040-XP25-ON08-03		○	40	55	25	55	111	5	3	0.5	
FMA07-040-XP25-ON08-03C	*	○	40	55	25	55	111	5	3	0.5	
FMA07-050-XP25-ON08-04		○	50	65	25	55	111	5	4	0.6	

● Ex stock ○ On demand

* With internal cooling

Spare parts			
	Insert	ONHU0604	ONHU08T5
		ØD	25-40
	Screw (insert)	I60M4×10 (3.4 Nm)	I60M5×13 (6.7 Nm)
	Wrench (insert)	WT15IS	
	Wrench (insert)		WT20IT

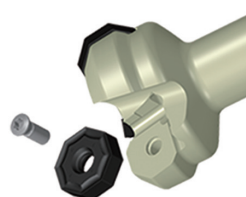

Milling inserts

- Ideal machining conditions
- ● Normal machining conditions
- ● Unfavourable machining conditions

ONHU	L	I.C	S	d
06 04	6.58	15.875	4.76	4.4
08 T5	8.39	20.2	5.77	5.3

ON**milling insert			HC ¹ (CVD)						HC ¹ (PVD)					HT	HC ²	HW										
	P		●	●	●	●	●	●	●	●	●	●	●	●	●	●										
	M		●	●	●	●	●	●	●	●	●	●	●	●	●	●										
	K								●						●		●									
	N								●							●	●									
	S			●	●				●	●	●	●	●	●												
	H																									
	ISO	r	YBC302	YBC301	YBC401	YBM253	YBM251	YBM351	YBD152	YBD252	YBG101	YBG102	YBG202	YBG212	YBS203	YBG205	YB9320	YBG302	YBS303	YBG252	YNG151		YNG151C	YD101	YD201	
	ONHU060408-CM							○																		
	ONHU08T512-CM			○				○																		
	ONHU060408-PF	0.8	○		○			●				○														
	ONHU08T508-PF	0.8	○		○			○				○				○										
	ONHU060408-PM	0.8	●		●			●								●										
	ONHU08T508-PM	0.8	○		○			○																		

● Ex stock ○ On demand

HC¹ Coated carbide
 HT Uncoated cermet
 HC² Coated cermet
 HW Uncoated carbide

A

Turning

B

Milling

C

Drilling

D

Technical Information

E

Index

System code > B26

Grade selection > B24

Technical info > B527

Cutting data > B230



Face milling

FMA07 Kr: 45°

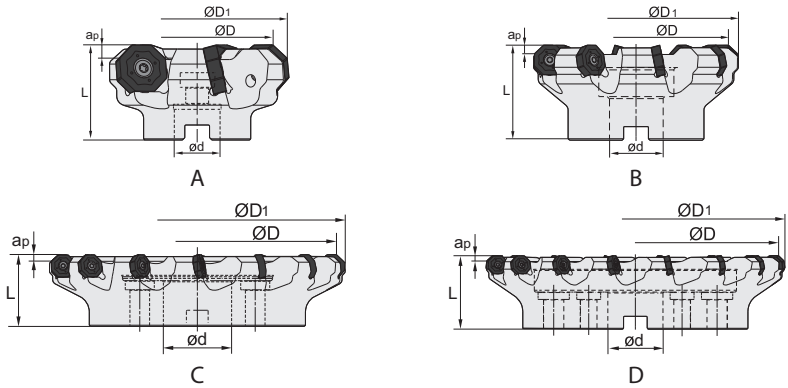
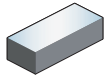

Article	*	Stock		Dimensions [mm]					Teeth	Coupling	kg	Inserts
		R	L	ØD	ØD ₁	ød	L	a _{p max}				
FMA07-050-A22-ON06-05		○	○	50	62	22	40	4	5	A	0.3	ONHU0604
FMA07-050-A22-ON06-05C	*	○		50	62	22	40	4	5	A	0.3	
FMA07-063-A22-ON06-06		○		63	75	22	40	4	6	A	0.5	
FMA07-063-A22-ON06-06C	*	○		63	75	22	40	4	6	A	0.5	
FMA07-080-A27-ON06-07C	*	○		80	92	27	50	4	7	A	1	
FMA07-080-B27-ON06-07		○		80	92	27	50	4	7	B	1	
FMA07-100-B32-ON06-08		○		100	112	32	63	4	8	B	1.9	
FMA07-100-B32-ON06-08C	*	○		100	112	32	63	4	8	B	1.9	
FMA07-125-B40-ON06-09		○		125	137	40	63	4	9	B	3.5	
FMA07-125-B40-ON06-09C	*	○		125	137	40	63	4	9	B	3.5	
FMA07-160-C40-ON06-11		○	○	160	172	40	63	4	11	C	4.3	
FMA07-200-C60-ON06-13		○		200	212	60	63	4	13	C	6.4	
FMA07-250-C60-ON06-15		○		250	262	60	63	4	15	C	13.4	
FMA07-315-D60-ON06-17		○		315	327	60	80	4	17	D	21.9	
FMA07-063-A22-ON08-05		○		63	78	22	40	5	5	A	0.5	
FMA07-063-A22-ON08-05C	*	○		63	78	22	40	5	5	A	0.5	
FMA07-080-A27-ON08-06C	*	○		80	95	27	50	5	6	A	0.9	
FMA07-080-B27-ON08-06		○	○	80	95	27	50	5	6	B	0.9	
FMA07-100-B32-ON08-07		○		100	115	32	63	5	7	B	1.8	
FMA07-100-B32-ON08-07C	*	○		100	115	32	63	5	8	B	3.1	
FMA07-125-B40-ON08-08		○	○	125	140	40	63	5	8	B	3.1	
FMA07-125-B40-ON08-08C	*	○		125	140	40	63	5	8	B	3.1	
FMA07-160-C40-ON08-10		○	○	160	175	40	63	5	10	C	4.1	
FMA07-200-C60-ON08-12		○	○	200	215	60	63	5	12	C	6.1	
FMA07-250-C60-ON08-14		○	○	250	265	60	63	5	14	C	12	
FMA07-315-D60-ON08-16		○	○	315	330	60	80	5	16	D	21	

● Ex stock ○ On demand





* With internal cooling

System code > B26



Grade selection > B24

Technical info > B527





Cutting data > B230

Spare parts			
Insert	ONHU0604	ONHU08T5	
ØD	50- 315	63- 315	
 Screw (insert)	I60M4×10 (3.4 Nm)	I60M5×13 (6.7 Nm)	
 Wrench (insert)	WT15IS		
 Wrench (insert)		WT20IT	

Milling inserts

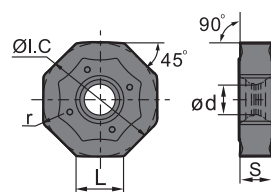
-  Ideal machining conditions
-  Normal machining conditions
-  Unfavourable machining conditions

ONHU	L	I.C	S	d
06 04	6.58	15.875	4.76	4.4
08 T5	8.39	20.2	5.77	5.3

ON**milling insert		HC ¹ (CVD)								HC ¹ (PVD)				HT	HC ²	HW													
		P	M	K	N	S	H	YBC302	YBC301	YBC401	YBM253	YBM251	YBM351	YBD152	YBD252	YBG101	YBG102	YBG202	YBG212	YBS203	YBG205	YB9320	YBG302	YBS303	YBG252	YNG151	YNG151C	YD101	YD201
ISO		r																											
	ONHU060408-CM																												
	ONHU08T512-CM																												
	ONHU060408-PF	0.8																											
	ONHU08T508-PF	0.8																											
	ONHU060408-PM	0.8																											
	ONHU08T508-PM	0.8																											

● Ex stock ○ On demand

HC¹ Coated carbide
 HT Uncoated cermet
 HC² Coated cermet
 HW Uncoated carbide

Face milling

FMA11 Kr: 45°

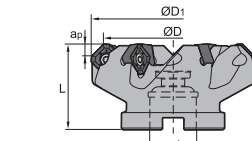
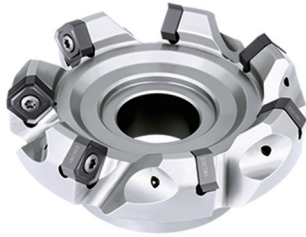
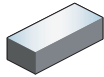

A

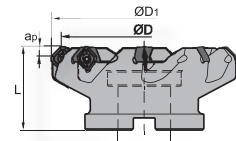

B

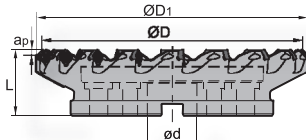

C

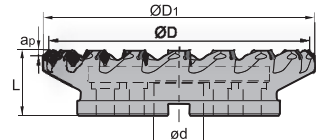

D

Article	*	Stock	Dimensions [mm]					Teeth	Coupling	kg	Inserts
			ØD	ØD ₁	ød	L	a _{p max}				
FMA11-063-A22-SN12-05C	*	●	63	74.47	22	40	5.5	5	A	0.55	SNEG1205
FMA11-063-A22-SN12-06C	*	●	63	74.47	22	40	5.5	6	A	0.58	
FMA11-080-A27-SN12-06C	*	●	80	91.47	27	50	5.5	6	A	1.14	
FMA11-100-B32-SN12-07		●	100	111.47	32	50	5.5	7	B	1.42	
FMA11-100-B32-SN12-07C	*	○	100	111.47	32	50	5.5	7	B	1.42	
FMA11-100-B32-SN12-10C	*	●	100	111.47	32	50	5.5	10	B	1.42	
FMA11-125-B40-SN12-08		●	125	136.47	40	63	5.5	8	B	2.86	
FMA11-125-B40-SN12-08C	*	○	125	136.47	40	63	5.5	8	B	2.86	
FMA11-125-B40-SN12-12C	*	●	125	136.47	40	63	5.5	12	B	2.86	
FMA11-160-C40-SN12-10		●	160	171.47	40	63	5.5	10	C	4.06	
FMA11-160-C40-SN12-15		●	160	171.47	40	63	5.5	15	C	4.06	
FMA11-200-C60-SN12-14		●	200	212.08	60	63	5.5	14	C	6.89	
FMA11-063-A22-SN15-05C	*	●	63	77.4	22	40	7	5	A	0.56	SNEG1506
FMA11-080-A27-SN15-06C	*	●	80	94.4	27	50	7	6	A	1.06	
FMA11-100-B32-SN15-07		●	100	114.4	32	50	7	7	B	1.47	
FMA11-100-B32-SN15-07C	*	○	100	114.4	32	50	7	7	B	1.47	
FMA11-100-B32-SN15-09C	*	●	100	114.4	32	50	7	9	B	1.47	
FMA11-125-B40-SN15-08		●	125	139.4	40	63	7	8	B	2.7	
FMA11-125-B40-SN15-08C	*	○	125	139.4	40	63	7	8	B	2.7	
FMA11-125-B40-SN15-10C	*	●	125	140.25	40	63	7	10	B	3.1	
FMA11-160-C40-SN15-10		●	160	174.4	40	63	7	10	C	3.92	
FMA11-160-C40-SN15-13		●	160	175.25	40	63	7	13	C	4.14	
FMA11-200-C60-SN15-12		●	200	214.4	60	63	7	12	C	5.46	
FMA11-250-C60-SN15-14		●	250	264.4	60	63	7	14	C	11.26	
FMA11-315-D60-SN15-18		○	315	329.4	60	80	7	18	D	20	
FMA11-125-B40-SN19-07		●	125	142.63	40	63	9	7	B	3	SNEG1907
FMA11-125-B40-SN19-07C	*	●	125	142.63	40	63	9	7	B	3	
FMA11-160-C40-SN19-09		●	160	167.63	40	63	9	9	C	4.25	
FMA11-200-C60-SN19-11		●	200	217.63	60	63	9	11	C	6.18	

● Ex stock ○ On demand

* With internal cooling

System code > B26

Grade selection > B24



Technical info > B527

Cutting data > B230

Article	* Stock	Dimensions [mm]					Teeth	Coupling	kg	Inserts
		ØD	ØD ₁	ød	L	a _{p max}				
FMA11-250-C60-SN19-13	●	250	267.63	60	63	9	13	C	11.55	SNEG1907
FMA11-315-D60-SN19-16	○	315	332.63	60	80	9	16	D	20.9	



● Ex stock ○ On demand

* With internal cooling











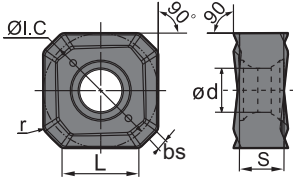





Spare parts				
	Insert	SNEG1205	SNEG1506	SNEG1907
	ØD	63-200	63-315	125-315
	Screw (insert)	I60M3.5x10 (2.7 Nm)	I60M5x13 (6.7 Nm)	I43M6x16 (9.1 Nm)
	Wrench (insert)	WT15IS		
	Wrench (insert)		WT20IT	WT25IT



SNEG	L	I.C	S	d
12 05	7.6	12	4.76	4.6
15 06	9.4	15	5.6	5.5
19 07	12.1	19	7	7.2

-  Ideal machining conditions
-  Normal machining conditions
-  Unfavourable machining conditions

Milling inserts

SN** negative insert				HC ¹ (CVD)				HC ¹ (PVD)				HT	HC ²	HW											
		P	M	K	N	S	H																		
																									
	ISO	r	bs	YBC302	YBC301	YBC401	YBM253	YBM251	YBM351	YBD152	YBD252	YBG101	YBG102	YBG202	YBG212	YBS203	YBG205	YBG920	YBG302	YBS303	YBG252	YNG151	YNG151C	YD101	YD201
	SNEG1506ANR-E	0.9	1.3													●									
	SNEG1205ANR-GM	0.8	1.05	●		●		●									●								
	SNEG1506ANR-GM	0.9	1.3	●		●		●									●								

● Ex stock ○ On demand

HC¹ Coated carbide
 HT Uncoated cermet
 HC² Coated cermet
 HW Uncoated carbide

System code > B26

Grade selection > B24

Technical info > B527

Cutting data > B230

A

Turning

B

Milling

C

Drilling

D

Technical Information

E

Index

- Ideal machining conditions
- ⊗ Normal machining conditions
- ⊗ Unfavourable machining conditions

SNEG	L	I.C	S	d
12 05	7.6	12	4.76	4.6
15 06	9.4	15	5.6	5.5
19 07	12.1	19	7	7.2

Milling inserts

SN** negative insert			HC ¹ (CVD)						HC ¹ (PVD)					HT	HC ²	HW										
	P	⊗	⊗	⊗	⊗	⊗	⊗	⊗	⊗	⊗	⊗	⊗	⊗	⊗	⊗											
	M	⊗	⊗	⊗	⊗	⊗	⊗	⊗	⊗	⊗	⊗	⊗	⊗	⊗	⊗											
	K						⊗	⊗	⊗	⊗	⊗	⊗	⊗	⊗	⊗	⊗										
	N						⊗	⊗	⊗	⊗	⊗	⊗	⊗	⊗	⊗	⊗										
	S			⊗	⊗		⊗	⊗	⊗	⊗	⊗	⊗	⊗	⊗	⊗	⊗										
	H																									
ISO		r	bs	YBC302	YBC301	YBC401	YBM253	YBM251	YBM351	YBD152	YBD252	YBG101	YBG102	YBG202	YBG212	YBS203	YBG205	YB9320	YBG302	YBS303	YBG252	YNG151	YNG151C	YD101	YD201	
	SNEG1205ANR-GR	0.8	1.05	●			●									○				○						
	SNEG1506ANR-GR	0.9	1.3	●			●									○					○					
	SNEG1907ANR-GR	1	1.67	●			●			●	●															
	SNEG1506ANR-HGR															○										

● Ex stock ○ On demand

HC¹ Coated carbide
HT Uncoated cermet
HC² Coated cermet
HW Uncoated carbide

- Ideal machining conditions
- ⊗ Normal machining conditions
- ⊗ Unfavourable machining conditions

SNEG	L	I.C	S	d
12 05	12	12	4.76	4.6

Milling inserts

SN** negative insert			HC ¹ (CVD)						HC ¹ (PVD)					HT	HC ²	HW									
	P	⊗	⊗	⊗	⊗	⊗	⊗	⊗	⊗	⊗	⊗	⊗	⊗	⊗	⊗										
	M	⊗	⊗	⊗	⊗	⊗	⊗	⊗	⊗	⊗	⊗	⊗	⊗	⊗	⊗	⊗									
	K							⊗	⊗	⊗	⊗	⊗	⊗	⊗	⊗	⊗	⊗								
	N							⊗	⊗	⊗	⊗	⊗	⊗	⊗	⊗	⊗	⊗								
	S				⊗	⊗		⊗	⊗	⊗	⊗	⊗	⊗	⊗	⊗	⊗	⊗								
	H																								
ISO		r1	r2	YBC302	YBC301	YBC401	YBM253	YBM251	YBM351	YBD152	YBD252	YBG101	YBG102	YBG202	YBG212	YBS203	YBG205	YB9320	YBG302	YBS303	YBG252	YNG151	YNG151C	YD101	YD201
	SNEG1205ANR-W	0.6	0.8																	●					

● Ex stock ○ On demand

HC¹ Coated carbide
HT Uncoated cermet
HC² Coated cermet
HW Uncoated carbide

System code > B26

Grade selection > B24

Technical info > B527

Cutting data > B230

Face milling

FMA12 Kr: 45°

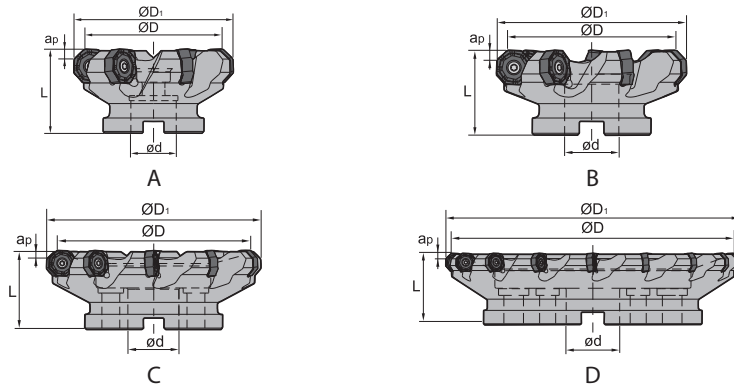
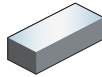

Article	*	Stock	Dimensions [mm]					Teeth	Coupling	kg	Inserts	
			ØD	ØD ₁	ød	L	a _{p max}					
FMA12-050-A22-ON06-04C	*	●	50	59	22	40	4	4	A	0.309	ON*U0604**	
FMA12-050-A22-ON06-05C	*	●	50	59	22	40	4	5	A	0.352		
FMA12-063-A27-ON06-05C	*	●	63	72	27	50	4	5	A	0.645		
FMA12-063-A27-ON06-07C	*	●	63	72	27	50	4	7	A	0.695		
FMA12-080-A27-ON06-07C	*	●	80	90	27	50	4	7	A	1.071		
FMA12-080-A27-ON06-09C	*	●	80	90	27	50	4	9	A	1.098		
FMA12-100-A32-ON06-08C	*	●	100	110	32	50	4	8	A	1.599		
FMA12-100-A32-ON06-11C	*	●	100	110	32	50	4	11	A	1.616		
FMA12-125-B40-ON06-10		●	125	135	40	63	4	10	B	3.114		
FMA12-125-B40-ON06-14		●	125	135	40	63	4	14	B	3.151		
FMA12-160-C40-ON06-12		●	160	170	40	63	4	12	C	4.504		
FMA12-160-C40-ON06-18		●	160	170	40	63	4	18	C	4.568		
FMA12-063-A22-ON08-05		○	63	78	22	50	5	5	A	0.6		ONHU08T6
FMA12-080-A27-ON08-06		○	80	95	27	50	5	6	A	0.97		
FMA12-100-B32-ON08-07		○	100	115	32	50	5	7	B	1.28		
FMA12-100-B32-ON08-07C	*	○	100	115	32	50	5	7	B	1.28		
FMA12-125-B40-ON08-08		○	125	140	40	63	5	8	B	2.59		
FMA12-125-B40-ON08-08C	*	○	125	140	40	63	5	8	B	2.59		
FMA12-160-C40-ON08-10		○	160	175	40	63	5	10	C	4.1		
FMA12-200-C60-ON08-12		○	200	215	60	63	5	12	C	5.68		
FMA12-250-C60-ON08-14		○	250	265	60	63	5	14	C	11.9		
FMA12-315-D60-ON08-18		○	315	330	60	80	5	18	D	20.41		

● Ex stock ○ On demand

* With internal cooling

System code > B26

Grade selection > B24

Technical info > B527

Cutting data > B230



A

Turning

B

Milling

C

Drilling

D



Technical Information

E

Index

A

Turning



Spare parts		ON*U0604**	ONHU08T6
Insert	ØD	50-160	63-315
	Screw (insert)		I60M5x13 (6.7Nm)
	Wrench (insert)	WT15IS	
	Wrench (insert)		WT20IT



B

Milling



Milling inserts

-  Ideal machining conditions
-  Normal machining conditions
-  Unfavourable machining conditions

ONHU	L	I.C	S	d
06 04	6.15	15.875	5.54	6
08 T6	6.38	20.2	6.3	5.3

C

Drilling

ON**milling insert			HC ¹ (CVD)						HC ¹ (PVD)				HT	HC ²	HW										
ISO		r	YBC302	YBC301	YBC401	YBM253	YBM251	YBM351	YBD152	YBD252	YBG101	YBG102	YBG202	YBG212	YBS203	YBG205	YB9320	YBG302	YBS303	YBG252	YNG151	YNG151C	YD101	YD201	
	ONHU060408ANN-GH ONMU060408-GH					●		●	●						●	●		○							
	ONHU060404ANN-GL					●			○						●	●		○							
	ONHU060408ANN-GM ONHU08T624R-GM ONMU060408-GM	0,8 2,4				●		●							●	●		○		●	●				

● Ex stock ○ On demand

HC¹ Coated carbide
HT Uncoated cermet
HC² Coated cermet
HW Uncoated carbide

D

Technical Information

E

Index

System code > B26

Grade selection > B24

Technical info > B527

Cutting data > B230

Face milling

FMD02 Kr: 67°

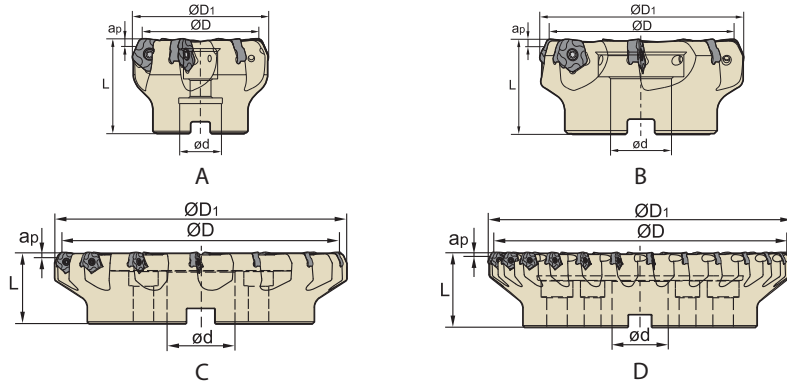
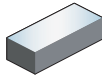

Article	*	Stock		Dimensions [mm]					Teeth	Coupling	kg	Inserts
		R	L	ØD	ØD ₁	ød	L	a _{p max}				
FMD02-050-A22-PN11-04	● ○	●	○	50	60.1	22	50	5	4	A	0.6	
FMD02-050-A22-PN11-04C	* ○	○	○	50	60.1	22	50	5	4	A	0.6	
FMD02-050-A22-PN11-05	●	●	○	50	60.1	22	50	5	5	A	0.6	
FMD02-050-A22-PN11-05C	* ●	●	○	50	60.1	22	50	5	5	A	0.6	
FMD02-063-A22-PN11-05	● ○	●	○	63	73.1	22	50	5	5	A	0.8	
FMD02-063-A22-PN11-05C	* ○	○	○	63	73.1	22	50	5	5	A	0.8	
FMD02-063-A22-PN11-06	●	●	○	63	73.1	22	50	5	6	A	0.9	
FMD02-063-A22-PN11-06C	* ●	●	○	63	73.1	22	50	5	6	A	0.9	
FMD02-080-A27-PN11-06	●	●	○	80	90.1	27	50	5	6	A	1.1	
FMD02-080-A27-PN11-08	●	●	○	80	90.1	27	50	5	8	A	1.2	
FMD02-080-A27-PN11-08C	* ●	●	○	80	90.1	27	50	5	8	A	1.2	
FMD02-100-B32-PN11-07	●	●	○	100	110.1	32	50	5	7	B	1.8	
FMD02-100-B32-PN11-07C	* ○	○	○	100	110.1	32	50	5	7	B	1.8	
FMD02-100-B32-PN11-10	●	●	○	100	110.1	32	50	5	10	B	1.9	
FMD02-100-B32-PN11-10C	* ○	○	○	100	110.1	32	50	5	10	B	1.9	
FMD02-125-B40-PN11-08	● ●	●	○	125	135.1	40	63	5	8	B	2.9	
FMD02-125-B40-PN11-08C	* ○	○	○	125	135.1	40	63	5	8	B	2.9	
FMD02-125-B40-PN11-12	● ○	●	○	125	135.1	40	63	5	12	B	3.2	
FMD02-125-B40-PN11-12C	* ○	○	○	125	135.1	40	63	5	12	B	3.2	
FMD02-160-B40-PN11-10	● ○	●	○	160	170.1	40	63	5	10	B	5.6	
FMD02-160-B40-PN11-14	● ○	●	○	160	170.1	40	63	5	14	B	6.4	
FMD02-200-C60-PN11-12	○ ○	○	○	200	210.1	60	63	5	12	C	7.9	
FMD02-200-C60-PN11-16	●	●	○	200	210.1	60	63	5	16	C	8.5	
FMD02-200-C60-PN11-20	○	○	○	200	210.1	60	63	5	20	C	8.5	
FMD02-200-C60-PN11-24	●	●	○	200	210.1	60	63	5	24	C	8.6	
FMD02-250-C60-PN11-14	○	○	○	250	260.1	60	63	5	14	C	13.4	
FMD02-250-C60-PN11-18	● ○	●	○	250	260.1	60	63	5	18	C	18	
FMD02-250-C60-PN11-30	○	○	○	250	260.1	60	63	5	30	C	13.5	
FMD02-315-D60-PN11-26	○ ○	○	○	315	325.1	60	80	5	26	D	24.5	

PNEG1105

● Ex stock ○ On demand

*With internal cooling

System code > B26

Grade selection > B24

Technical info > B527

Cutting data > B230



A

Turning

B

Milling

C

Drilling

D

Technical Information

E

Index

A

Turning

Spare parts		
Insert	PNEG1105	
ØD	50-315	
	Screw (insert)	I60M4x10 (3.4Nm)
	Wrench (insert)	WT15IS

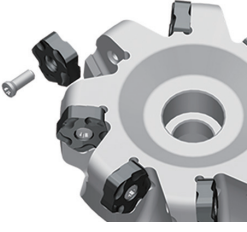

B

Milling

- Ideal machining conditions
- Normal machining conditions
- Unfavourable machining conditions

PNEG	L	I.C	S	d
11 05	7.5	15.875	5.56	4.64

Milling inserts

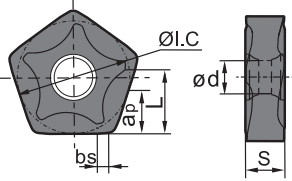
PN** milling insert		HC ¹ (CVD)							HC ¹ (PVD)					HT	HC ²	HW										
		P	M	K	N	S	H																			
		YBC302	YBC301	YBC401	YBM253	YBM251	YBM351	YBD152	YBD252	YBG101	YBG102	YBG202	YBG212	YBS203	YBG205	YB9320	YBG302	YBS303	YBG252	YNG151	YNG151C	YD101	YD201			
ISO	bs	a _p max																								
	PNEG110512L-PF	1.6	7.5																							
	PNEG110512R-PF	1.6	7.5																							
	PNEG110512L-PM	1.6	7.5																							
	PNEG110512R-PM																									
	PNEG110512L-PR	1.6	7.5																							
	PNEG110512R-PR	1.6	7.5																							

● Ex stock ○ On demand

HC¹ Coated carbide
 HT Uncoated cermet
 HC² Coated cermet
 HW Uncoated carbide

C

Drilling

D

Technical Information

E

Index

System code > B26

Grade selection > B24



Technical info > B527

Cutting data > B230

- Ideal machining conditions
- ⊗ Normal machining conditions
- ⊗ Unfavourable machining conditions

PNEG	L	I.C	S	d
11 05	5.4	15.875	5.56	4.64

Milling inserts

PN** milling insert		HC ¹ (CVD)							HC ¹ (PVD)					HT	HC ²	HW										
ISO		bs	a _p max	YBC302	YBC301	YBC401	YBM253	YBM251	YBM351	YBD152	YBD252	YBG101	YBG102	YBG202	YBG212	YBS203	YBG205	YB9320	YBG302	YBS303	YBG252	YNG151	YNG151C	YD101	YD201	
	PNEG110512L-CF	1.6	5							○																
	PNEG110512R-CF	1.6	5							●																
	PNEG110512L-CM	1.6	5							○																
	PNEG110512R-CM	1.6	5							●																
	PNEG110512L-CR	1.6	5							○ ○																
	PNEG110512R-CR	1.6	5							● ●																

● Ex stock ○ On demand

HC¹ Coated carbide
 HT Uncoated cermet
 HC² Coated cermet
 HW Uncoated carbide

A

Turning

B

Milling

C

Drilling

D

Technical Information

E

Index

System code > B26

Grade selection > B24

Technical info > B527

Cutting data > B230



Face milling

FMD02 Kr: 67°

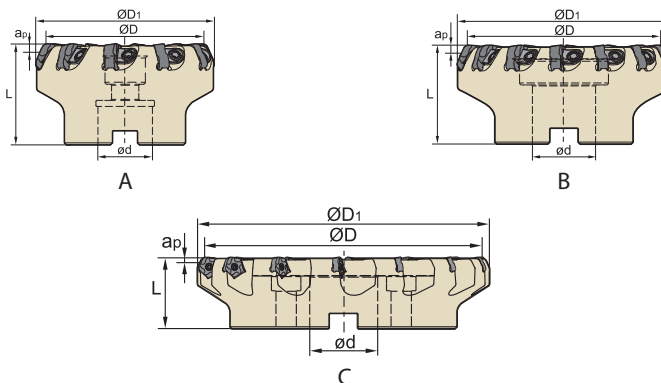
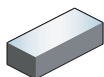

Article	*	Stock		Dimensions [mm]					Teeth	Coupling	kg	Inserts
		R	L	ØD	ØD ₁	ød	L	a _{p max}				
FMD02-080-A27-PN11-10	●			80	90.1	27	50	5	10	A	1.3	PNEG1105
FMD02-100-B32-PN11-14	●	○		100	110.1	32	50	5	14	B	1.6	
FMD02-125-B40-PN11-18	●			125	135.1	40	63	5	18	B	3.2	
FMD02-160-B40-PN11-22	●			160	170.1	40	63	5	22	B	5.8	
FMD02-200-C60-PN11-28	○	○		200	210.1	60	63	5	28	C	8.5	

● Ex stock ○ On demand

* With internal cooling

Spare parts		
	Insert	PNEG1105
	ØD	80-200
	Screw (wedge)	DM6x20A (7.0Nm)
	Wedge	W18N
	Wrench (wedge)	WT15IT

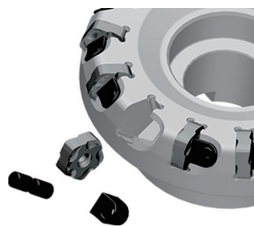

- Ideal machining conditions
- Normal machining conditions
- Unfavourable machining conditions

PNEG	L	I.C	S	d
11 05	7.5	15.875	5.56	4.64

Milling inserts

PN** milling insert				HC ¹ (CVD)						HC ¹ (PVD)					HT	HC ²	HW								
		P	●	●	●	●	●	●	●	●	●	●	●	●	●	●									
		M	●	●	●	●	●	●	●	●	●	●	●	●	●	●									
		K						●	●	●	●														
		N						●									●	●							
		S			●	●					●	●	●	●	●	●									
		H																							
ISO		bs	ap max	YBC302	YBC301	YBC401	YBM253	YBM251	YBM351	YBD152	YBD252	YBG101	YBG102	YBG202	YBG212	YBS203	YBG205	YB9320	YBG302	YBS303	YBG252	YNG151	YNG151C	YD101	YD201
	PNEG110512L-PF	1.6	7.5	○																					
	PNEG110512R-PF	1.6	7.5	○			○																		
	PNEG110512L-PM	1.6	7.5	○			○																		
	PNEG110512R-PM			●			●			○															
	PNEG110512L-PR	1.6	7.5	○			●																		
	PNEG110512R-PR	1.6	7.5	○			●																		

● Ex stock ○ On demand

HC¹ Coated carbide
 HT Uncoated cermet
 HC² Coated cermet
 HW Uncoated carbide

- Ideal machining conditions
- Normal machining conditions
- Unfavourable machining conditions

PNEG	L	I.C	S	d
11 05	5.4	15.875	5.56	4.64

Milling inserts

PN** milling insert				HC ¹ (CVD)						HC ¹ (PVD)					HT	HC ²	HW								
		P	●	●	●	●	●	●	●	●	●	●	●	●	●										
		M	●	●	●	●	●	●	●	●	●	●	●	●	●										
		K						●	●	●	●														
		N						●									●	●							
		S			●	●					●	●	●	●	●	●									
		H																							
ISO		bs	ap max	YBC302	YBC301	YBC401	YBM253	YBM251	YBM351	YBD152	YBD252	YBG101	YBG102	YBG202	YBG212	YBS203	YBG205	YB9320	YBG302	YBS303	YBG252	YNG151	YNG151C	YD101	YD201
	PNEG110512L-CF	1.6	5							○															
	PNEG110512R-CF	1.6	5							●															

● Ex stock ○ On demand

HC¹ Coated carbide
 HT Uncoated cermet
 HC² Coated cermet
 HW Uncoated carbide

A

Turning

B

Milling

C

Drilling

D

Technical Information



E

Index

- Ideal machining conditions
- Normal machining conditions
- Unfavourable machining conditions

PNEG	L	I.C	S	d
11 05	5.4	15.875	5.56	4.64

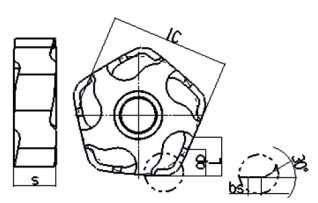
Milling inserts

PN** milling insert				HC ¹ (CVD)						HC ¹ (PVD)						HT	HC ²	HW							
	P																								
	M																								
	K																								
	N																								
	S																								
	H																								
ISO		bs	a _{p max}	YBC302	YBC301	YBC401	YBM253	YBM251	YBM351	YBD152	YBD252	YBG101	YBG102	YBG202	YBG212	YBS203	YBG205	YB9320	YBG302	YBS303	YBG252	YNG151	YNG151C	YD101	YD201
	PNEG110512L-CM	1.6	5							○															
	PNEG110512R-CM	1.6	5							●															
	PNEG110512L-CR	1.6	5							○	○														
	PNEG110512R-CR	1.6	5							●	●														

● Ex stock ○ On demand

HC¹ Coated carbide
 HT Uncoated cermet
 HC² Coated cermet
 HW Uncoated carbide

System code > B26

Grade selection > B24

Technical info > B527

Cutting data > B230

Face milling

FMD02 Kr: 55°

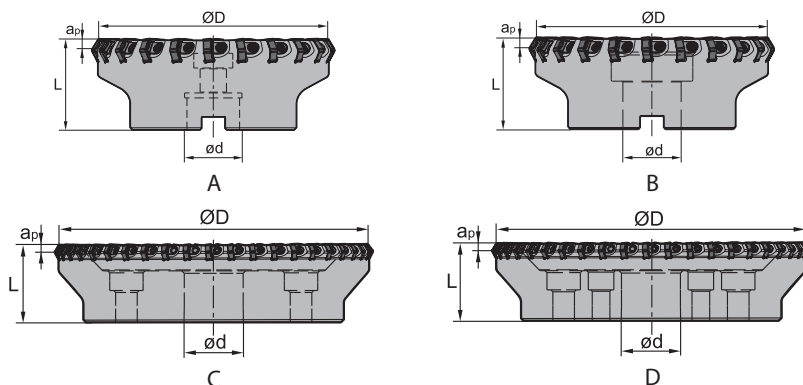
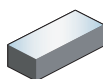

Article	*	Stock		Dimensions [mm]				Teeth	Coupling	kg	Inserts
		R	L	ØD	ød	L	ap max				
FMD02-080-A27-HN09-08	○			80	27	50	6	8	A	1.19	HNEX0905
FMD02-100-B32-HN09-10	○			100	32	50	6	10	B	1.77	
FMD02-125-B40-HN09-14	○			125	40	63	6	14	B	3.55	
FMD02-125-B40-HN09-18	○			125	40	63	6	18	B	3.7	
FMD02-160-B40-HN09-18	●			160	40	63	6	18	B	5.62	
FMD02-160-B40-HN09-22	○			160	40	63	6	22	B	5.6	
FMD02-200-C60-HN09-22	○			200	60	63	6	22	C	6.7	
FMD02-250-C60-HN09-28	○	○		250	60	63	6	28	C	13	
FMD02-315-D60-HN09-44	○			315	60	63	6	44	D	21.7	

● Ex stock ○ On demand

* With internal cooling

Spare parts			
Insert	HNEX0905		
ØD	80- 315		
Screw (wedge)	DM6×20A (7.0Nm)		
Wedge	W18N		
Wrench (wedge)	WT15IT		

System code > B26

Grade selection > B24

Technical info > B527

Cutting data > B230

A

Turning

B

Milling

C

Drilling

D

Technical Information

E

Index

- Ideal machining conditions
- ⊗ Normal machining conditions
- ⊗ Unfavourable machining conditions

HNEX	L	I.C	S
09 05	9.16	15.875	5.56

Milling inserts

HN** milling insert		HC ¹ (CVD)						HC ¹ (PVD)						HT	HC ²	HW								
	P	⊗	⊗	⊗	⊗	⊗	⊗	⊗	⊗	⊗	⊗	⊗	⊗	●	●	●								
	M	⊗	⊗	⊗	⊗	⊗	⊗	⊗	⊗	⊗	⊗	⊗	⊗	●	●	●								
	K							⊗						●		⊗								
	N							⊗							⊗	⊗								
	S		⊗	⊗				⊗	⊗	⊗	⊗	⊗	⊗											
	H																							
ISO		r	YBC302	YBC301	YBC401	YBM253	YBM251	YBM351	YBD152	YBD252	YBG101	YBG102	YBG202	YBG212	YBS203	YBG205	YB9320	YBG302	YBS303	YBG252	YNG151	YNG151C	YD101	YD201
	HNEX090512-DR	1.2					●	●																

● Ex stock ○ On demand

HC¹ Coated carbide
 HT Uncoated cermet
 HC² Coated cermet
 HW Uncoated carbide

System code > B26

Grade selection > B24

Technical info > B527

Cutting data > B230



Face milling

FMD03 Kr: 60°

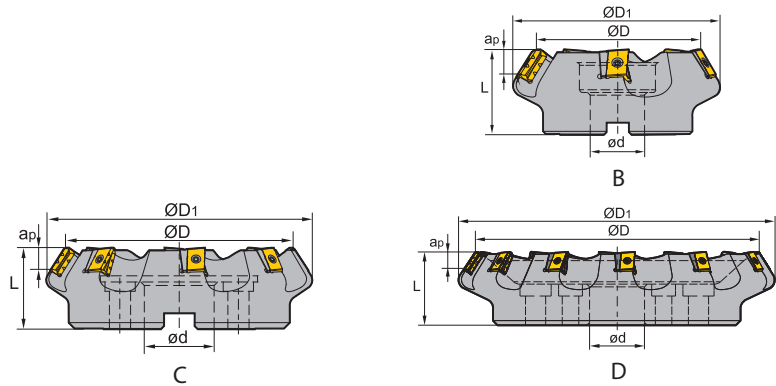
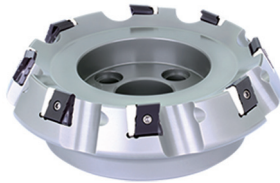
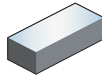

Article	*	Stock		Dimensions [mm]					Teeth	Coupling	kg	Inserts	
		R	L	ØD	ØD ₁	ød	L	a _{p max}					
FMD03-100-B32-LN20-05	○			100	129	32	63	12	5	B	3.02	LNKT2007-ZR	
FMD03-125-B40-LN20-06	●			125	153	40	63	12	6	B	4.5		
FMD03-160-C40-LN20-08	●			160	187	40	63	12	8	C	6.9		
FMD03-160-C40-LN20-09	○			160	187	40	63	12	9	C	6.7		
FMD03-200-C60-LN20-10	●			200	227	60	70	12	10	C	10.5		
FMD03-250-C60-LN20-12	●			250	276	60	70	12	12	C	13.4		
FMD03-315-D60-LN20-15	○			315	339	60	80	12	15	D	26.2		
FMD03-125-B40-LN25-05	○			125	154	40	63	16	5	B	4.5		LNKT2510-ZR
FMD03-160-C40-LN25-06	●			160	189	40	63	16	6	C	6.9		
FMD03-200-C60-LN25-08	●			200	229	60	70	16	8	C	10.5		
FMD03-250-C60-LN25-10	●			250	278	60	70	16	10	C	16.7		
FMD03-315-D60-LN25-12	○ ○			315	346	60	80	16	12	D	27.3		
FMD03-400-D60-LN25-16	○ ○			400	427	60	80	16	16	D	47.1		

● Ex stock ○ On demand

* With internal cooling

Spare parts			
	Insert	LNKT2007-ZR	LNKT2510-ZR
	ØD	100- 315	125 -400
	Screw (insert)	I60M4×15 (3.4 Nm)	I60M5×17 (6.7 Nm)
	Screw (shim)	I60M3×7	I60M3.5×10.4
	Shim	LLN20R-ZR	LLN25R-ZR
	Wrench (shim)	WT09IS	WT15IS
	Wrench (insert)	WT15IS	
	Wrench (insert)		WT20IT

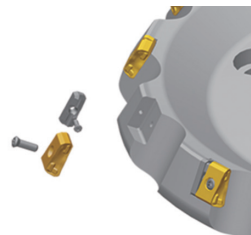

System code > B26

Grade selection > B24

Technical info > B527

Cutting data > B230

A

Turning

B

Milling

C

Drilling

D

Technical Information

E

Index

A

Turning

B

Milling

C

Drilling

D

Technical Information



E

Index

- Ideal machining conditions
- ⊗ Normal machining conditions
- ⊗ Unfavourable machining conditions

LNKT	L	S	d
20 07	20	7.94	4.6
25 10	25	9.525	5.5

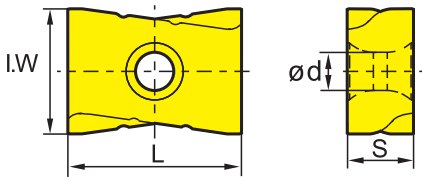
Milling inserts

LN** milling insert		HC ¹ (CVD)						HC ¹ (PVD)					HT	HC ²	HW									
	P	⊗	⊗	⊗	⊗	⊗	⊗	⊗	⊗	⊗	⊗	⊗	⊗	⊗										
	M	⊗	⊗	⊗	⊗	⊗	⊗	⊗	⊗	⊗	⊗	⊗	⊗	⊗										
	K					⊗	⊗	⊗						⊗		⊗								
	N							⊗								⊗								
	S			⊗	⊗			⊗	⊗	⊗	⊗	⊗	⊗											
	H																							
ISO	I.W	YBC302	YBC301	YBC401	YBM253	YBM251	YBM351	YBD152	YBD252	YBG101	YBG102	YBG202	YBG212	YBS203	YBG205	YB9320	YBG302	YBS303	YBG252	YNG151	YNG151C	YD101	YD201	
	LNKT2007DN-ZR	17			●	●		○									●							
	LNKT2510-ZR	18					●	●									●							

● Ex stock ○ On demand

HC¹ Coated carbide
 HT Uncoated cermet
 HC² Coated cermet
 HW Uncoated carbide

System code > B26

Grade selection > B24

Technical info > B527

Cutting data > B230

Face milling

FME02 Kr: 75°

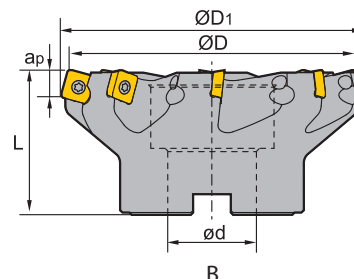
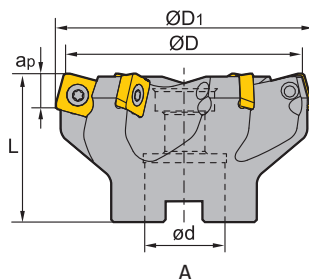
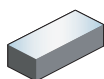



Article	*	Stock	Dimensions [mm]					Teeth	Coupling	kg	Inserts
			ØD	ØD ₁	ød	L	a _{p max}				
FME02-050-A22-SP12-04	●		50	54	22	40	6	4	A	0.3	 SPKT1204 SPKW1204
FME02-063-A22-SP12-05	●		63	66	22	50	6	5	A	0.6	
FME02-080-A27-SP12-06	●		80	83	27	50	6	6	A	0.9	
FME02-100-B32-SP12-07	●		100	103	32	50	6	7	B	1.4	
FME02-125-B40-SP12-08	●		125	128	40	63	6	8	B	2.5	

● Ex stock ○ On demand

* With internal cooling

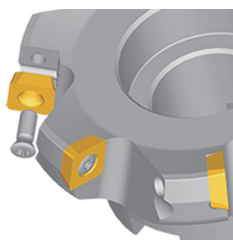
Spare parts

Insert		SPKT1204 SPKW1204	
ØD		50-125	
	Screw (insert)	I60M5x13.2 (6.7 Nm)	
	Wrench (insert)	WT20IS	

A

Turning

B

Milling

C

Drilling

D

Technical
Information

E

Index

System code > B26

Grade selection > B24

Technical info > B527

Cutting data > B230

A

Turning

B

Milling

C

Drilling

D

Technical Information

E

Index

- Ideal machining conditions
- ⊗ Normal machining conditions
- ⊗ Unfavourable machining conditions

SPKW	L	I.C	S	d
12 04	12.7	12.7	4.76	5.56

Milling inserts

SP** milling insert		HC ¹ (CVD)						HC ¹ (PVD)					HT	HC ²	HW									
	P	⊗	⊗	⊗	⊗	⊗	⊗	⊗	⊗	⊗	⊗	⊗	⊗	⊗										
	M	⊗	⊗	⊗	⊗	⊗	⊗	⊗	⊗	⊗	⊗	⊗	⊗	⊗										
	K															⊗								
	N															⊗								
	S		⊗	⊗					⊗	⊗	⊗	⊗	⊗											
	H																							
ISO		YBC302	YBC301	YBC401	YBM253	YBM251	YBM351	YBD152	YBD252	YBG101	YBG102	YBG202	YBG212	YBS203	YBG205	YB9320	YBG302	YBS303	YBG252	YNG151	YNG151C	YD101	YD201	
	SPKW1204EDFR											○												
	SPKW1204EDSR											○												

● Ex stock ○ On demand

HC¹ Coated carbide
 HT Uncoated cermet
 HC² Coated cermet
 HW Uncoated carbide

- Ideal machining conditions
- ⊗ Normal machining conditions
- ⊗ Unfavourable machining conditions

SPKT	L	I.C	S	d
12 04	12.7	12.7	4.76	5.56

Milling inserts

SP** milling insert		HC ¹ (CVD)						HC ¹ (PVD)					HT	HC ²	HW								
	P	⊗	⊗	⊗	⊗	⊗	⊗	⊗	⊗	⊗	⊗	⊗	⊗	⊗									
	M	⊗	⊗	⊗	⊗	⊗	⊗	⊗	⊗	⊗	⊗	⊗	⊗	⊗									
	K															⊗							
	N															⊗							
	S		⊗	⊗							⊗	⊗	⊗	⊗									
	H																						
ISO		YBC302	YBC301	YBC401	YBM253	YBM251	YBM351	YBD152	YBD252	YBG101	YBG102	YBG202	YBG212	YBS203	YBG205	YB9320	YBG302	YBS303	YBG252	YNG151	YNG151C	YD101	YD201
	SPKT1204EDR											○											

● Ex stock ○ On demand

HC¹ Coated carbide
 HT Uncoated cermet
 HC² Coated cermet
 HW Uncoated carbide

System code > B26

Grade selection > B24

Technical info > B527

Cutting data > B230

Face milling

FME03 Kr: 75°

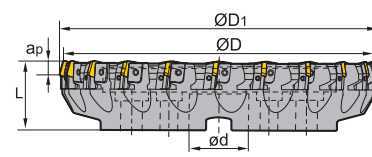
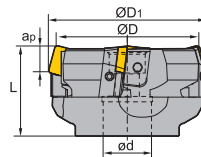
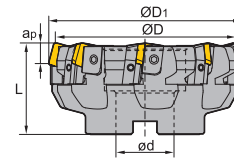
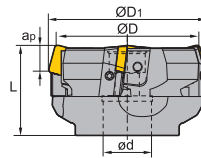
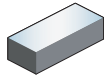

Article	*	Stock		Dimensions [mm]					Teeth	Coupling	kg	Inserts	
		R	L	ØD	ØD ₁	ød	L	a _{p max}					
FME03-080-A27-SP12-04		○		80	84	27	50	6	4	A	1.1	SPKN1203 SPKR1203 SPEX1203	
FME03-100-B32-SP12-06		●		100	104	32	50	6	6	B	1.9		
FME03-125-B40-SP12-08		○	○	125	129	40	63	6	8	B	3.5		
FME03-160-B40-SP12-10		●	○	160	164	40	63	6	10	B	5.7		
FME03-200-C60-SP12-12		○	○	200	203	60	63	6	12	C	8.2		
FME03-250-C60-SP12-16		○	○	250	253	60	63	6	16	C	13.8		
FME03-315-D60-SP12-20		○		315	318	60	70	6	20	D	23.5		
FME03-080-A27-SP15-04		○	○	80	84	27	50	8	4	A	1		SPKN1504 SPKR1504 SPEX1504
FME03-100-B27-SP15-06		○		100	104	27	50	8	6	B	1.8		
FME03-125-B40-SP15-08		●	○	125	129	40	63	8	8	B	3.3		
FME03-160-B40-SP15-10		○	○	160	164	40	63	8	10	B	5.4		
FME03-200-C60-SP15-12		○	○	200	204	60	63	8	12	C	7.9		
FME03-250-C60-SP15-16		○	○	250	253	60	63	8	16	C	13.6		
FME03-315-D60-SP15-20		○	○	315	318	60	70	8	20	D	23.1		

● Ex stock ○ On demand

* With internal cooling

A

Turning

B

Milling

C

Drilling

D

Technical Information

E

Index

A

Turning

B

Milling

C

Drilling

D

Technical Information

E

Index

Spare parts		SPKN1203 SPKR1203 SPEX1203	SPKN1203 SPKR1203 SPEX1203	SPKN1504 SPKR1504 SPEX1504
Insert		80-100	125 - 315	80- 315
ØD		80-100	125 - 315	80- 315
	Adjustable screw	LOM5×15.1	LOM5×15.1	LOM5×15.1
	Cassette (left)	LSP12L	LSP12L	LSP15L
	Cassette (right)	LSP12R	LSP12R	LSP15R
	Screw (wedge)	WM8×17	WM8×22	WM8×22
	Wedge (left)	W04L	W04L	W04L
	Wedge (right)	W04R	W04R	W04R
	Wrench (locator)	WT20T	WT20T	WT20T
	Wrench (wedge)	WT25T	WT25T	WT25T

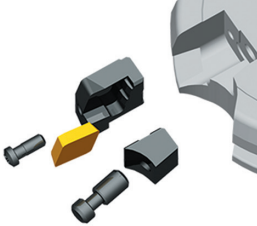

Milling inserts

- Ideal machining conditions
- ⊗ Normal machining conditions
- ⊗ Unfavourable machining conditions

SPKN	L	I.C	S
12 03	12.7	12.7	3.18
15 04	15.875	15.875	4.76

SP** milling insert		HC ¹ (CVD)						HC ¹ (PVD)				HT	HC ²	HW													
ISO		be	bs	YBC302	YBC301	YBC401	YBM253	YBM251	YBM351	YBD152	YBD252	YBG101	YBG102	YBG202	YBG212	YBS203	YBG205	YB9320	YBG302	YBS303	YBG252	YNG151	YNG151C	YD101	YD201		
	SPKN1203EDFL	1	1.4	●	●	●	●	●	●	●	●	●	●	●	●	●	●	●	●	●	●	●				●	
	SPKN1203EDFR	1	1.4										○													●	
	SPKN1203EDSKL	1	1.4	●																							
	SPKN1203EDSKR	1	1.4	●							○			○							●						
	SPKN1203EDTKR	1	1.4						○												○						
	SPKN1504EDFL	1	1.4																								○
	SPKN1504EDFR	1	1.4																								○
	SPKN1504EDS32PR	1	1.4			○										○											
	SPKN1504EDSKL	1	1.4																								
	SPKN1504EDSKR	1	1.4	●							●			○							●						
	SPKN1504EDTKR	1	1.4												○												

● Ex stock ○ On demand



HC¹ Coated carbide
 HT Uncoated cermet
 HC² Coated cermet
 HW Uncoated carbide

System code > B26

Grade selection > B24

Technical info > B527



Cutting data > B230

-  Ideal machining conditions
-  Normal machining conditions
-  Unfavourable machining conditions

SPKR	L	I.C	S
12 03	12.7	12.7	3.18
15 04	15.875	15.875	4.76

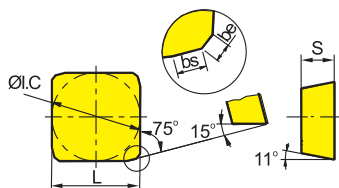
Milling inserts



SP** milling insert		HC ¹ (CVD)							HC ¹ (PVD)					HT	HC ²	HW									
ISO		be	bs	YBC302	YBC301	YBC401	YBM253	YBM251	YBM351	YBD152	YBD252	YBG101	YBG102	YBG202	YBG212	YBS203	YBG205	YB9320	YBG302	YBS303	YBG252	YNG151	YNG151C	YD101	YD201
	SPKR1203EDL-GM	1	1.4					○																	
	SPKR1203EDR-GM	1	1.4					●																	
	SPKR1504EDR-GM	1	1.4				○							○											
	SPKR1203EDR	1	1.4	○																					

● Ex stock ○ On demand

HC¹ Coated carbide
 HT Uncoated cermet
 HC² Coated cermet
 HW Uncoated carbide

A

Turning

B

Milling

C

Drilling

D

Technical Information

E

Index

System code > B26

Grade selection > B24

Technical info > B527

Cutting data > B230



Face milling

FME04 Kr: 75°

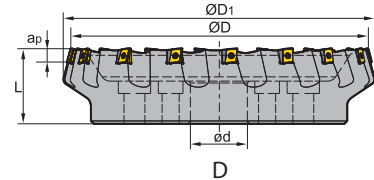
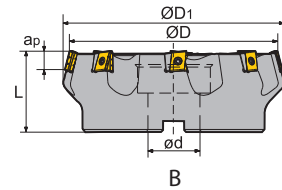
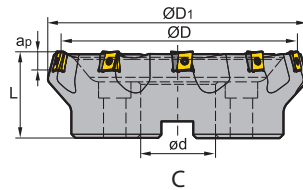
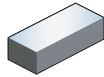

Article	*	Stock	Dimensions [mm]					Teeth	Coupling	kg	Inserts
			ØD	ØD ₁	ød	L	a _{p max}				
FME04-125-B40-LN15-06		●	125	137	40	63	10	6	B	3.8	LNKT1506-ZR
FME04-200-C60-LN15-10		●	200	208	60	70	10	10	C	9.6	
FME04-250-C60-LN15-12		○	250	257	60	70	10	12	C	13.4	
FME04-315-D60-LN15-16		○	315	328	60	80	10	16	D	25.2	

● Ex stock ○ On demand

* With internal cooling

Spare parts



	Insert	LNKT1506-ZR	
	ØD	125 - 315	
	Screw (insert)	I60M4x12 (3.4Nm)	
	Screw (shim)	I60M3x7	
	Shim	LLN15-ZR	
	Wrench (shim)	WT09IS	
	Wrench (insert)	WT15IS	

System code > B26

Grade selection > B24











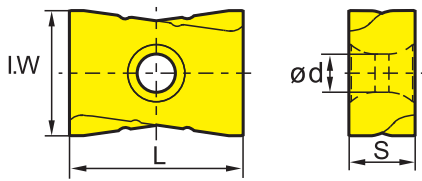





























Technical info > B527

Cutting data > B230

-  Ideal machining conditions
-  Normal machining conditions
-  Unfavourable machining conditions

LNKT	L	S	d
15 06	15.875	6.35	4.6

Milling inserts

LN** milling insert		HC ¹ (CVD)						HC ¹ (PVD)					HT	HC ²	HW									
	P																							
	M																							
	K																							
	N																							
	S																							
	H																							
ISO	I.W	YBC302	YBC301	YBC401	YBM253	YBM251	YBM351	YBD152	YBD252	YBG101	YBG102	YBG202	YBG212	YBS203	YBG205	YB9320	YBG302	YBS303	YBG252	YNG151	YNG151C	YD101	YD201	
	LNKT1506EN-ZR	14	●		○	●	●	●									○							

● Ex stock ○ On demand

HC¹ Coated carbide
 HT Uncoated cermet
 HC² Coated cermet
 HW Uncoated carbide



Face milling

FMP01 Kr: 90°

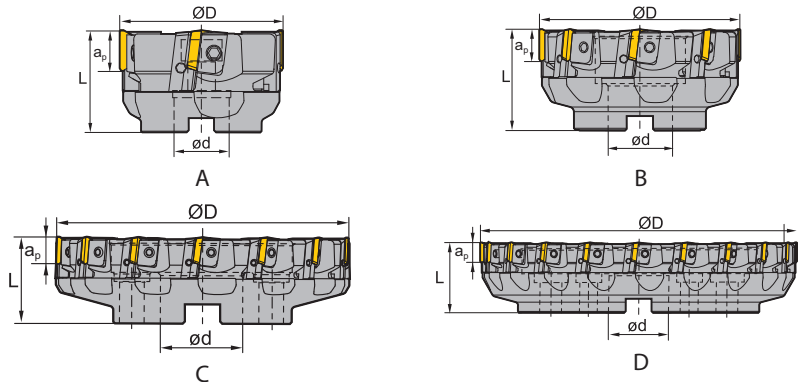
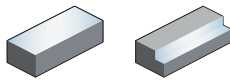

Article	*	Stock		Dimensions [mm]				Teeth	Coupling	kg	Inserts
		R	L	ØD	ød	L	a _{p max}				
FMP01-080-A27-TP22-04	●			80	27	50	18	4	A	1.2	TPKN2204
FMP01-100-B32-TP22-06	●			100	32	50	18	6	B	1.7	
FMP01-125-B40-TP22-08	●	○		125	40	63	18	8	B	3.2	
FMP01-160-B40-TP22-10	●	○		160	40	63	18	10	B	5.1	
FMP01-200-C60-TP22-12	●	○		200	60	63	18	12	C	7.4	
FMP01-250-C60-TP22-16	○	○		250	60	63	18	16	C	12.3	
FMP01-315-D60-TP22-20	○	○		315	60	70	18	20	D	21.9	

● Ex stock ○ On demand

* With internal cooling

Spare parts

	Insert ØD	TPKN2204	TPKN2204
		80-100	125 - 315
	Adjustable screw	LOM5×15.1	LOM5×15.1
	Cassette (left)	LTP4L1	LTP4L
	Cassette (right)	LTP4R1	LTP4R
	Screw (wedge)	WM8×17	WM8×22
	Wedge (left)	W04L	W04L
	Wedge (right)	W04R	W04R
	Wrench (locator)	WT20T	WT20T
	Wrench (wedge)	WT25T	WT25T

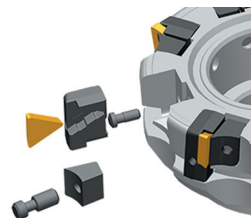

System code > B26

Grade selection > B24

Technical info > B527

Cutting data > B230

- Ideal machining conditions
- ⊗ Normal machining conditions
- ⊗ Unfavourable machining conditions

TPKN	L	I.C	S
22 04	22	12.7	4.76

Milling inserts

TP** milling insert				HC ¹ (CVD)						HC ¹ (PVD)					HT	HC ²	HW												
				P	M	K	N	S	H																				
ISO				be	bs	an	YBC302	YBC301	YBC401	YBM253	YBM251	YBM351	YBD152	YBD252	YBG101	YBG102	YBG202	YBG212	YBS203	YBG205	YB9320	YBG302	YBS303	YBG252	YNG151	YNG151C	YD101	YD201	
	TPKN2204PDFR	1.4	0.7	11°											○														
	TPKN2204PDS32PR	1.4	0.7	11°													○			○									
	TPKN2204PDSKL	1.4	0.7	11°	○																								
	TPKN2204PDSKR	1.4	0.7	11°	●	●		●	●							○				●	●								
	TPKN2204PDTKR	1.4	0.7	11°											●														

● Ex stock ○ On demand

HC¹ Coated carbide
 HT Uncoated cermet
 HC² Coated cermet
 HW Uncoated carbide

A Turning
B Milling
C Drilling
D Technical Information
E Index



Face milling

FMP02 Kr: 90°

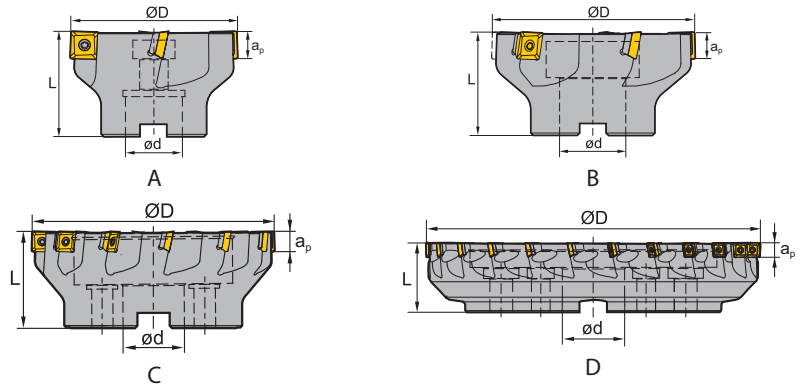
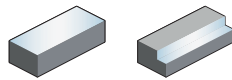

Article	*	Stock	Dimensions [mm]				Teeth	Coupling	kg	Inserts
			ØD	ød	L	a _{p max}				
FMP02-050-A22-SE09-05		●	50	22	40	6.7	5	A	0.3	SEET09T3
FMP02-050-A22-SE09-05C	*	●	50	22	40	6.7	5	A	0.3	
FMP02-063-A22-SE09-06		●	63	22	40	6.7	6	A	0.5	
FMP02-063-A22-SE09-06C	*	●	63	22	40	6.7	6	A	0.5	
FMP02-080-A27-SE09-08		●	80	27	50	6.7	8	A	0.9	
FMP02-100-B32-SE09-08		○	100	32	50	6.7	8	B	1.7	
FMP02-100-B32-SE09-10		○	100	32	50	6.7	10	B	1.7	
FMP02-100-B32-SE09-10C	*	○	100	32	50	6.7	10	B	1.7	
FMP02-125-B40-SE09-12		●	125	40	63	6.7	12	B	2.6	
FMP02-125-B40-SE09-12C	*	○	125	40	63	6.7	12	B	2.6	
FMP02-050-A22-SE12-03		○	50	22	40	10.8	3	A	0.3	SEET1203
FMP02-050-A22-SE12-03C	*	○	50	22	40	10.8	3	A	0.3	
FMP02-050-A22-SE12-04		●	50	22	40	10.8	4	A	0.3	
FMP02-050-A22-SE12-04C	*	●	50	22	40	10.8	4	A	0.3	
FMP02-050-A22-SE12-05		●	50	22	40	10.8	5	A	0.2	
FMP02-050-A22-SE12-05C	*	○	50	22	40	10.8	5	A	0.2	
FMP02-063-A22-SE12-04		○	63	22	40	10.8	4	A	0.4	
FMP02-063-A22-SE12-05		●	63	22	40	10.8	5	A	0.4	
FMP02-063-A22-SE12-05C	*	●	63	22	40	10.8	5	A	0.4	
FMP02-063-A22-SE12-06		●	63	22	40	10.8	6	A	0.4	
FMP02-063-A22-SE12-06C	*	○	63	22	40	10.8	6	A	0.4	
FMP02-080-A27-SE12-04		○	80	27	50	10.8	4	A	0.9	
FMP02-080-A27-SE12-06		●	80	27	50	10.8	6	A	0.8	
FMP02-080-A27-SE12-06C	*	●	80	27	50	10.8	6	A	0.8	
FMP02-080-A27-SE12-08		●	80	27	50	10.8	8	A	0.8	
FMP02-080-A27-SE12-08C	*	○	80	27	50	10.8	8	A	0.8	
FMP02-100-B32-SE12-05		●	100	32	50	10.8	5	B	1.2	
FMP02-100-B32-SE12-07		●	100	32	50	10.8	7	B	1.2	
FMP02-100-B32-SE12-10		●	100	32	50	10.8	10	B	1.2	

● Ex stock ○ On demand

* With internal cooling

System code > B26

Grade selection > B24







Technical info > B527

Cutting data > B230

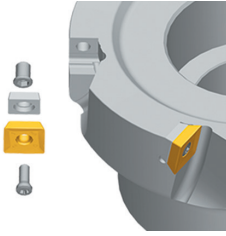

Article	*	Stock	Dimensions [mm]				Teeth	Coupling	kg	Inserts 
			ØD	ød	L	a _{p max}				
FMP02-100-B32-SE12-10C	*	○	100	32	50	10.8	10	B	1.2	SEET1203
FMP02-125-B40-SE12-06		○	125	40	63	10.8	6	B	3.1	
FMP02-125-B40-SE12-08		●	125	40	63	10.8	8	B	3	
FMP02-125-B40-SE12-08C	*	○	125	40	63	10.8	8	B	3	
FMP02-125-B40-SE12-12		●	125	40	63	10.8	12	B	2.9	
FMP02-160-C40-SE12-08		●	160	40	63	10.8	8	C	4.1	
FMP02-160-C40-SE12-12		●	160	40	63	10.8	12	C	3.9	
FMP02-250-C60-SE12-12		○	250	60	63	10.8	12	C	11.1	
FMP02-250-C60-SE12-18		●	250	60	63	10.8	18	C	10.9	
FMP02-315-D60-SE12-24		○	315	60	63	10.8	24	D	21.6	

● Ex stock ○ On demand











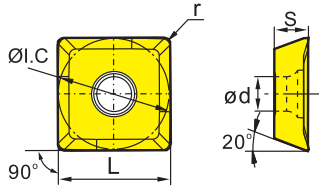

* With internal cooling

Spare parts					
Insert	SEET09T3	SEET1203	SEET1203	SEET1203	
ØD	50-125	50	63-315		
 Screw (insert)	I60M3×7 (1.8 Nm)	I60M3.5×10 (2.7 Nm)	I60M3.5×12 (2.7 Nm)		
 Screw (shim)			SM5×7XA		
 Shim			S12BSX		
 Wrench (shim)			WH35L		
 Wrench (insert)	WT09IS	WT15IS	WT15IS		

Milling inserts

-  Ideal machining conditions
-  Normal machining conditions
-  Unfavourable machining conditions

SEET	L	I.C	S	d
09 T3	9.525	9.525	4.01	3.3
12 03	13.308	13.308	4.04	4.1

SE** milling insert	HC ¹ (CVD)						HC ¹ (PVD)			HT	HC ²	HW											
	P	M	K	N	S	H																	
																							
ISO	r	YBC302	YBC301	YBC401	YBM253	YBM251	YBM351	YBD152	YBD252	YBG101	YBG102	YBG202	YBG212	YBS203	YBG205	YB9320	YBG302	YBS303	YBG252	YNG151	YNG151C	YD101	YD201
 SEET09T308PER-APF	0.8					○									●								

● Ex stock ○ On demand

HC¹ Coated carbide
 HT Uncoated cermet
 HC² Coated cermet
 HW Uncoated carbide

A
Turning

B
Milling

C
Drilling

D
Technical Information

E
Index

A

Turning

B

Milling

C

Drilling

D

Technical Information

E

Index

- Ideal machining conditions
- Normal machining conditions
- Unfavourable machining conditions

SEET	L	I.C	S	d
09 T3	9.525	9.525	4.01	3.3
12 03	13.308	13.308	4.04	4.1

Milling inserts

SE** milling insert		HC ¹ (CVD)						HC ¹ (PVD)					HT	HC ²	HW									
		P	M	K	N	S	H																	
ISO		r	YBC302	YBC301	YBC401	YBM253	YBM251	YBM351	YBD152	YBD252	YBG101	YBG102	YBG202	YBG212	YBS203	YBG205	YB9320	YBG302	YBS303	YBG252	YNG151	YNG151C	YD101	YD201
	SEET09T308PER-APM	0.8					○										●							
	SEET09T308PER-APR	0.8					○										○							
	SEET120308PER-APF	0.8					○				○						●							
	SEET120308PER-APM	0.8					●				○						●							
	SEET120308PER-APR	0.8					●				○						●							
	SEET120308-LH	0.8								○	○													●
	SEET09T308PER-PF	0.8										○												
	SEET120308PER-PF	0.8	○																					
	SEET09T308PER-PM	0.8							○			○												
	SEET120308PER-PM	0.8	○				○	○	○	○		○	○				○							
	SEET09T308PER-PR	0.8							○								○							
	SEET120308PER-PR	0.8	○				○	○	○		○	○					○							

● Ex stock ○ On demand

HC¹ Coated carbide
 HT Uncoated cermet
 HC² Coated cermet
 HW Uncoated carbide

System code > B26

Grade selection > B24

Technical info > B527

Cutting data > B230

Face milling

FMP03 Kr: 89°

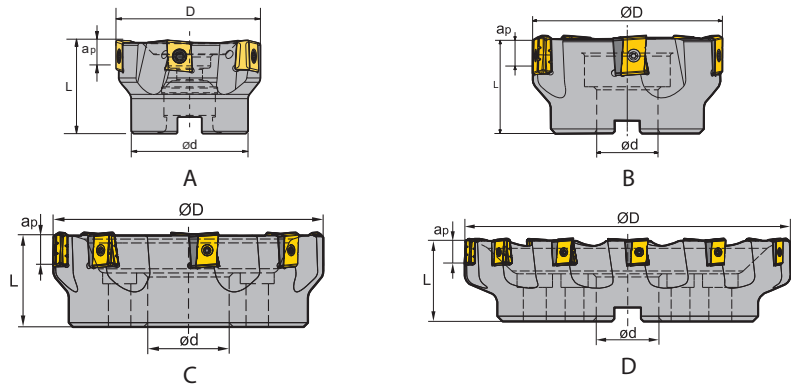
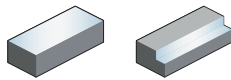

Article	*	Stock		Dimensions [mm]				Teeth	Coupling	kg	Inserts
		R	L	ØD	ød	L	ap max				
FMP03-050-A22-LN12-04C	*	●		50	22	40	7	4	A	0.3	LNKT120608-ZR
FMP03-050-A22-LN12-05C	*	○		50	22	40	7	5	A	0.3	
FMP03-063-A22-LN12-05C	*	●		63	22	40	7	5	A	0.5	
FMP03-063-A27-LN12-05C	*	○		63	27	50	7	5	A	0.64	
FMP03-063-A22-LN12-06C	*	○		63	22	40	7	6	A	0.5	
FMP03-063-A27-LN12-06C	*	●		63	27	50	7	6	A	0.65	
FMP03-063-A27-LN12-07C	*	○		63	27	50	7	7	A	0.64	
FMP03-080-A27-LN12-06C	*	●		80	27	50	7	6	A	1	
FMP03-080-A27-LN12-07C	*	○		80	27	50	7	7	A	1	
FMP03-100-B32-LN12-06		○		100	32	50	7	6	B	1.47	
FMP03-125-B40-LN15-06		●		125	40	63	12	6	B	3.2	
FMP03-160-C40-LN15-08		●		160	40	63	12	8	C	5.1	
FMP03-160-C40-LN15-09		○		160	40	63	12	9	C		
FMP03-200-C60-LN15-10		●		200	60	70	12	10	C	7.5	
FMP03-250-C60-LN15-12		○		250	60	70	12	12	C	12.2	
FMP03-250-C60-LN15-13		○		250	60	70	12	13	C		
FMP03-315-D60-LN15-16		○		315	60	80	12	16	D	23.7	
FMP03-125-B40-LN20-06		○		125	40	63	16	6	B	3.3	
FMP03-160-C40-LN20-08		●		160	40	63	16	8	C	5.3	
FMP03-200-C60-LN20-10		●		200	60	70	16	10	C	8.8	
FMP03-200-C60-LN20-11		○		200	60	70	16	11	C		
FMP03-250-C60-LN20-12		●		250	60	70	16	12	C	14	
FMP03-315-D60-LN20-15		○		315	60	80	16	15	D	23.9	
FMP03-125-B40-LN25-05		○		125	40	63	20	5	B	3.3	
FMP03-160-C40-LN25-06		○ ○		160	40	63	20	6	C	5.1	
FMP03-200-C60-LN25-08		○		200	60	70	20	8	C	8.9	
FMP03-250-C60-LN25-10		● ○		250	60	70	20	10	C	12	
FMP03-315-D60-LN25-12		○ ○		315	60	80	20	12	D	21.9	

● Ex stock ○ On demand

* With internal cooling

System code > B26

Grade selection > B24

Technical info > B527

Cutting data > B230



A

Turning

B

Milling

C

Drilling

D

Technical Information

E

Index

A

Turning

B

Milling

C

Drilling

D

Technical Information

E

Index

Spare parts

Insert	LNKT120608-ZR	LNKT1506EN-ZR	LNKT2007DN-ZR	LNKT2510-ZR
ØD	50-100	125 - 315	125 - 315	125 - 315
Screw (insert)	I60M4×12 (3.4 Nm)	I60M4×12 (3.4 Nm)	I60M4×15 (3.4 Nm)	I60M5×17 (6.7 Nm)
Screw (shim)		I60M3×7	I60M3×7	I60M3.5×10.4
Shim		LLN15-ZR	LLN20R-ZR	LLN25R-ZR
Wrench (shim)		WT09IS	WT09IS	WT15IS
Wrench (insert)	WT15IS	WT15IS	WT15IS	
Wrench (insert)				WT20IT

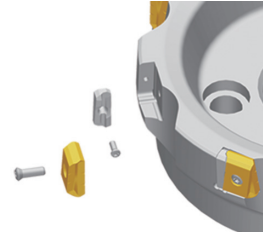

LNKT	L	S	d
12 06	12.7	6.65	4.4
15 06	15.875	6.35	4.6
20 07	20	7.94	4.6
25 10	25	9.525	5.5

- Ideal machining conditions
- ⊗ Normal machining conditions
- ⊗ Unfavourable machining conditions

Milling inserts

LN** milling insert	HC ¹ (CVD)						HC ¹ (PVD)						HT	HC ²	HW
	P	M	K	N	S	H	P	M	K	N	S	H			
	●	●	●	●	●	●	●	●	●	●	●	●	●	●	●
ISO	I.W	YBC302 YBC301 YBC401	YBM253 YBM251 YBM351	YBD152 YBD252	YBG101 YBG102	YBG202 YBG212 YBS203 YBG205 YB9320 YBG302 YBS303 YBG252	YNG151	YNG151C	YD101 YD201						
	LNKT120608-ZR	12	●	●											
	LNKT1506EN-ZR	14	●	○	●	●									
	LNKT2007DN-ZR	17		●	●	○									
	LNKT2510-ZR	18			●	●									

● Ex stock ○ On demand

HC¹ Coated carbide
HT Uncoated cermet
HC² Coated cermet
HW Uncoated carbide

System code > B26

Grade selection > B24

Technical info > B527

Cutting data > B230

Face milling

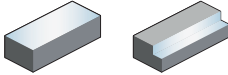

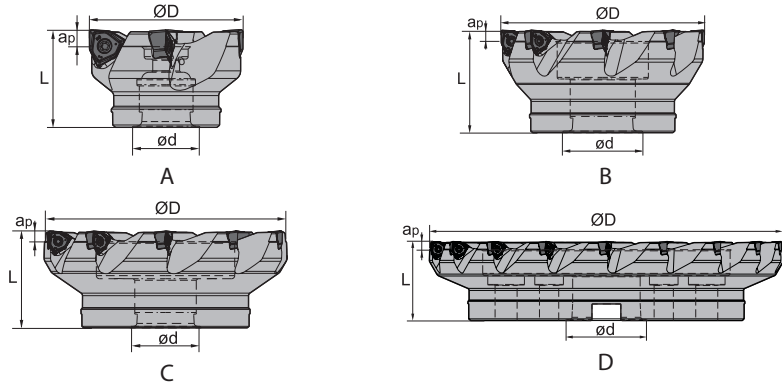
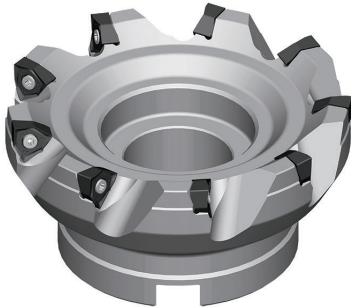
FMP12 Kr: 90° 



Article	*	Stock	Dimensions [mm]			Teeth	Coupling	kg	Inserts
			ØD	ød	ap _{max}				
FMP12-050-A22-WN06-05C	*	○	50	22	5.7	5	A	0.55	WNHU0604
FMP12-063-A22-WN06-06C	*	●	63	22	5.7	6	A	0.45	
FMP12-080-A27-WN06-07C	*	●	80	27	5.7	7	A	1	
FMP12-100-B32-WN06-09		●	100	32	5.7	9	A	1.4	
FMP12-100-B32-WN06-09C	*	●	100	32	5.7	9	A	1.4	
FMP12-125-B40-WN06-11C	*	○	125	40	5.7	11	B	3.4	
FMP12-160-C40-WN06-14		○	160	40	5.7	14	C	5.4	WNHU0806
FMP12-063-A22-WN08-04C	*	●	63	22	7.7	4	A	0.39	
FMP12-063-A22-WN08-05C	*	●	63	22	7.7	5	A	0.45	
FMP12-080-A27-WN08-05C	*	●	80	27	7.7	5	A	0.95	
FMP12-100-B32-WN08-06		●	100	32	7.7	6	B	1.32	
FMP12-100-B32-WN08-06C	*	●	100	32	7.7	6	B	1.32	
FMP12-125-B40-WN08-08C	*	○	125	40	7.7	8	B	3.3	
FMP12-160-C40-WN08-10		○	160	40	7.7	10	C	5.2	
FMP12-200-C60-WN08-12		○	200	60	7.7	12	C		
FMP12-250-C60-WN08-14		○	250	60	7.7	14	C		
FMP12-315-D60-WN08-18		○	315	60	7.7	18	D		

● Ex stock ○ On demand

* With internal cooling

Spare parts			
	Insert	WNHU0604	WNHU0806
	Screw (insert)	50-315 I60M3×9 (1.8 Nm)	50-315 I60M4×10 (3.4 Nm)
	Wrench (insert)	WT09IS	
	Wrench (insert)		WT20IT

System code > B26

Grade selection > B24

Technical info > B527

Cutting data > B230



A

Turning

B

Milling

C

Drilling

D

Technical Information

E

Index

A

Turning

B

Milling

C

Drilling

D

Technical Information

E

Index

- Ideal machining conditions
- ⊗ Normal machining conditions
- ⊗ Unfavourable machining conditions

WNHU	L	I.C	S	d
06 04	5.73	9.525	4.704	3.5
08 06	7.76	12.7	6.32	4.4

Milling inserts

WN** negative insert		HC ¹ (CVD)						HC ¹ (PVD)					HT	HC ²	HW									
	P	⊗	⊗	⊗	⊗	⊗	⊗	⊗	⊗	⊗	⊗	⊗	⊗	⊗										
	M	⊗	⊗	⊗	⊗	⊗	⊗	⊗	⊗	⊗	⊗	⊗	⊗	⊗										
	K							⊗	⊗							⊗								
	N							⊗								⊗								
	S			⊗	⊗			⊗	⊗	⊗	⊗	⊗	⊗											
	H																							
ISO		r	YBC302	YBC301	YBC401	YBM253	YBM251	YBM351	YBD152	YBD252	YBG101	YBG102	YBG202	YBG212	YBS203	YBG205	YB9320	YBG302	YBS303	YBG252	YNG151	YNG151C	YD101	YD201
	WNHU060404PNR-GM	0.4				○			○							○								
	WNHU060408PNR-GM	0.8				●			○	○						○								
	WNHU080608PNR-GM	0.8				●		●	●						●									
	WNHU080616PNR-GM	1.6				○			●	○														

● Ex stock ○ On demand

HC¹ Coated carbide
 HT Uncoated cermet
 HC² Coated cermet
 HW Uncoated carbide

System code > B26

Grade selection > B24

Technical info > B527

Cutting data > B230



Face milling

FMP12 Kr: 90°

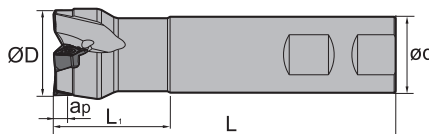
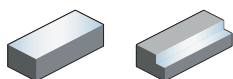

Article	*	Stock	Dimensions [mm]					Teeth	Coupling	kg	Inserts
			ØD	ød	L ₁	L	a _{p max}				
FMP12-025-XP25-WN06-02C	*	○	25	25	30	100	5,7	2	XP	0.38	WNHU0604
FMP12-032-XP25-WN06-03C	*	○	32	25	40	120	5,7	3	XP	0.47	
FMP12-040-XP32-WN06-04C	*	○	40	32	40	140	5,7	4	XP	0.85	
FMP12-050-XP40-WN06-05C	*	○	50	40	40	169	5,7	5	XP	1.59	

● Ex stock ○ On demand

* With internal cooling

Spare parts

Insert		WNHU0604	
ØD		25-50	
	Screw (insert)	I60M3x9 (1.8Nm)	
	Wrench (insert)	WT09IS	

System code > B26

Grade selection > B24

Technical info > B527

Cutting data > B230

A

Turning

B

Milling

C

Drilling

D

Technical Information

E

Index

- Ideal machining conditions
- Normal machining conditions
- Unfavourable machining conditions

WNHU	L	I.C	S	d
06 04	5.73	9.525	4.704	3.5

Milling inserts

WN** negative insert		HC ¹ (CVD)						HC ¹ (PVD)						HT	HC ²	HW								
	P	●	●	●	●	●	●	●	●	●	●	●	●	●	●									
	M	●	●	●	●	●	●	●	●	●	●	●	●	●	●									
	K					●	●	●								●								
	N							●								●								
	S		●	●				●	●	●	●	●	●											
	H																							
ISO		r	YBC302	YBC301	YBC401	YBM253	YBM251	YBM351	YBD152	YBD252	YBG101	YBG102	YBG202	YBG212	YBS203	YBG205	YB9320	YBG302	YBS303	YBG252	YNG151	YNG151C	YD101	YD201
	WNHU060404PNR-GM	0.4				○										○								
	WNHU060408PNR-GM	0.8				●			○	○						○								

● Ex stock ○ On demand

HC¹ Coated carbide
 HT Uncoated cermet
 HC² Coated cermet
 HW Uncoated carbide

System code > B26

Grade selection > B24

Technical info > B527

Cutting data > B230

IMPORTANT INFORMATION

Notes on using the FMWX series

Please note the following: The milling body is only equipped with two opposing inserts.

Select insert seat **1.1** in combination with **1.2** or insert seat **2.1** in combination with **2.2**.

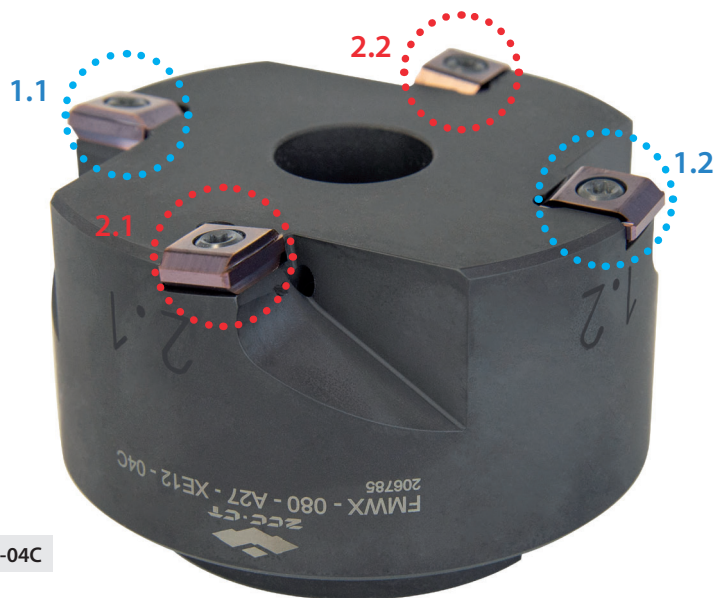

Fig.: FMWX-063-A27-XE12-04C

Cutting data

ISO group	Material	v_c (m/min)	F_n [mm/rev]	a_p [mm]
P	Low-alloy steel	300–400	3,50–5,00	0,02–0,05
M	Stainless steels	280–300	3,50–5,00	0,02–0,05
K	Cast steel	300–400	3,50–5,00	0,02–0,05

Face milling

FMWX

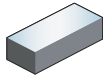

Screw Clamping

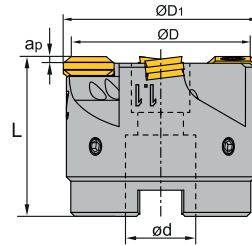

Article	*	Stock	Dimensions [mm]				Teeth	Coupling	kg	Inserts
			$\varnothing D_1$	$\varnothing d$	L	$a_{p\ max}$				
FMWX-050-A22-XE12-04C	*	○	46	22	40	0.1	4	A	0.3	XEEC1209
FMWX-063-A27-XE12-04C	*	○	59	27	40	0.1	4	A	0.5	
FMWX-080-A27-XE12-04C	*	○	76	27	50	0.1	4	A	1	
FMWX-100-B32-XE12-06C	*	○	96	32	50	0.1	6	B	1.9	
FMWX-125-B40-XE12-06C	*	○	121	40	63	0.1	6	B	3.5	

● Ex stock ○ On demand

* With internal cooling



Spare parts		
	Insert	XEEC1209
	$\varnothing D$	50-125
	Screw (insert)	I60M4x10 (3.4Nm)

System code > B26

Grade selection > B24



Technical info > B527

Cutting data > B230

-  Ideal machining conditions
-  Normal machining conditions
-  Unfavourable machining conditions

XEEC
12 09

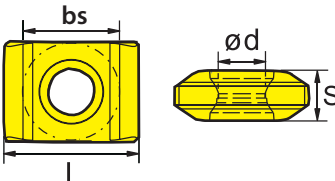
Milling inserts

XE** positive insert		HC ¹ (CVD)						HC ¹ (PVD)						HT	HC ²	HW								
	P																							
	M																							
	K																							
	N																							
	S																							
	H																							
ISO		YBC302	YBC301	YBC401	YBM253	YBM251	YBM351	YBD152	YBD252	YBG101	YBG102	YBG202	YBG212	YBS203	YBG205	YB9320	YBG302	YBS303	YBG252	YNG151	YNG151C	YD101	YD201	
	XEEC120904						●																	

● Ex stock ○ On demand

HC¹ Coated carbide
HT Uncoated cermet
HC² Coated cermet
HW Uncoated carbide

Face milling

FMR01

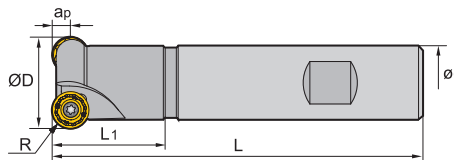
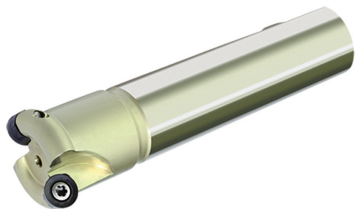
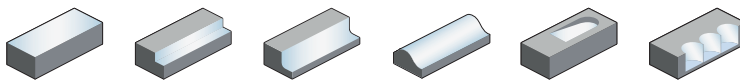

Article	*	Stock	Dimensions [mm]						Teeth	kg	Inserts
			R	ØD	ød	L ₁	L	a _{p max}			
FMR01-025-XP20-RC10-02		○	5	25	20	30	100	5	2	0.2	RCKT10T3
FMR01-025-XP20-RC10-02C	*	○	5	25	20	30	100	5	2	0.2	
FMR01-032-XP25-RC10-02		●	5	32	25	35	120	5	2	0.5	
FMR01-032-XP25-RC10-02C	*	●	5	32	25	35	120	5	2	0.5	
FMR01-040-XP32-RC12-03		●	6	40	32	40	120	6	3	0.7	RCKT1204 RCGX1204
FMR01-040-XP32-RC12-03C	*	●	6	40	32	40	120	6	3	0.7	
FMR01-050-XP32-RC12-03		●	6	50	32	40	120	6	3	0.8	

● Ex stock ○ On demand

* With internal cooling

Spare parts

	Insert	RCKT10T3	RCKT1204 RCGX1204	
		ØD	25-32	
Screw (insert)		I60M4×8.4 (3.4 Nm)	I60M3.5×10 (2.7 Nm)	
Wrench (insert)		WT15S	WT15S	

System code > B26

Grade selection > B24

Technical info > B527

Cutting data > B230

- Ideal machining conditions
- ⊗ Normal machining conditions
- ⊗ Unfavourable machining conditions

RCKT	I.C	S	d
10 T3	10	3.97	4.4
12 04	12	4.76	4

Milling inserts

RC** milling insert		HC ¹ (CVD)						HC ¹ (PVD)					HT	HC ²	HW									
	P	⊗	⊗	⊗	⊗	⊗	⊗	⊗	⊗	⊗	⊗	⊗	⊗	⊗										
	M	⊗	⊗	⊗	⊗	⊗	⊗	⊗	⊗	⊗	⊗	⊗	⊗	⊗										
	K							⊗	⊗	⊗	⊗	⊗	⊗	⊗	⊗									
	N							⊗	⊗	⊗	⊗	⊗	⊗	⊗	⊗									
	S							⊗	⊗	⊗	⊗	⊗	⊗	⊗	⊗									
	H																							
ISO		YBC302	YBC301	YBC401	YBM253	YBM251	YBM351	YBD152	YBD252	YBG101	YBG102	YBG202	YBG212	YBS203	YBG205	YB9320	YBG302	YBS303	YBG252	YNG151	YNG151C	YD101	YD201	
	RCKT10T3MO-DM		○									○				●	○							
	RCKT1204MO-DM		○	○	○	●	○					○				●	○							
	RCKT1204MO-DR		○	○	○	●									●									
	RCKT1204MO-ER				●																			
	RCKT1204MO-NM											○												

● Ex stock ○ On demand

HC¹ Coated carbide
 HT Uncoated cermet
 HC² Coated cermet
 HW Uncoated carbide

Milling inserts

- Ideal machining conditions
- ⊗ Normal machining conditions
- ⊗ Unfavourable machining conditions

RCGX	I.C	S	d
12 04	12	4.76	4

RC** positive insert		HC ¹ (CVD)						HC ¹ (PVD)					HT	HC ²	HW									
	P	⊗	⊗	⊗	⊗	⊗	⊗	⊗	⊗	⊗	⊗	⊗	⊗	⊗										
	M	⊗	⊗	⊗	⊗	⊗	⊗	⊗	⊗	⊗	⊗	⊗	⊗	⊗										
	K							⊗	⊗	⊗	⊗	⊗	⊗	⊗	⊗									
	N							⊗	⊗	⊗	⊗	⊗	⊗	⊗	⊗									
	S							⊗	⊗	⊗	⊗	⊗	⊗	⊗	⊗									
	H																							
ISO		YBC302	YBC301	YBC401	YBM253	YBM251	YBM351	YBD152	YBD252	YBG101	YBG102	YBG202	YBG212	YBS203	YBG205	YB9320	YBG302	YBS303	YBG252	YNG151	YNG151C	YD101	YD201	
	RCGX1204MO-LH																						●	

● Ex stock ○ On demand

HC¹ Coated carbide
 HT Uncoated cermet
 HC² Coated cermet
 HW Uncoated carbide

Face milling

FMR02

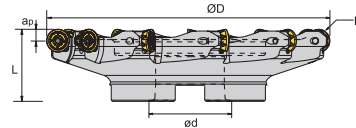
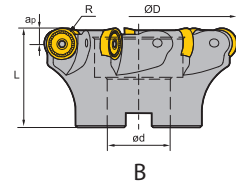
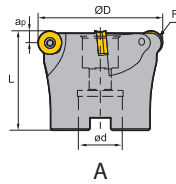
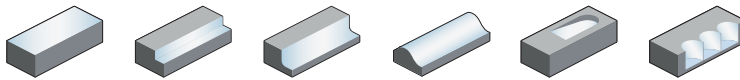

C

Article	*	Stock	Dimensions [mm]					Teeth	Coupling	kg	Inserts
			R	ØD	ød	L	ap _{max}				
FMR02-050-A22-RC12-05C	*	●	6	50	22	40	6	5	A	0.7	RCGX1204 RCKT1204 RCMW1204
FMR02-050-A22-RC12-06C	*	○	6	50	22	40	6	6	A	0.7	
FMR02-052-A22-RC12-05C	*	●	6	52	22	40	6	5	A	0.7	
FMR02-063-A22-RC12-04		●	6	63	22	40	6	4	A	0.7	
FMR02-063-A22-RC12-05C	*	●	6	63	22	40	6	5	A	0.7	
FMR02-063-A22-RC12-06		●	6	63	22	40	6	6	A	0.7	
FMR02-063-A22-RC12-06C	*	●	6	63	22	40	6	6	A	0.7	RCKT1606
FMR02-080-A27-RC12-07C	*	●	6	80	27	50	6	7	B	0.7	
FMR02-100-B32-RC12-08C	*	●	6	100	32	50	6	8	B	0.89	
FMR02-063-A22-RC16-04		●	8	63	22	40	8	4	A	0.7	
FMR02-063-A22-RC16-04C	*	○	8	63	22	40	8	4	A	0.7	
FMR02-063-A22-RC16-05C	*	○	8	63	22	40	8	5	A	0.7	
FMR02-066-A27-RC16-05C(FB)	*	●	8	66	27	50	8	5	A	0.5	RCKT2006
FMR02-080-B27-RC16-05		●	8	80	27	50	8	5	B	0.7	
FMR02-080-B27-RC16-07		●	8	80	27	50	8	7	B	0.7	
FMR02-100-B32-RC16-06		●	8	100	32	63	8	6	B	1.2	
FMR02-100-A32-RC16-06C	*	○	8	100	32	63	8	6	B	1.2	
FMR02-125-B40-RC16-07		●	8	125	40	63	8	7	B	2.5	
FMR02-125-B40-RC16-07C	*	○	8	125	40	63	8	7	B	2.5	RCKT2006
FMR02-160-B40-RC16-10(FB)		○	8	160	40	63	8	10	B	3.94	
FMR02-200-C60-RC16-12(FB)		●	8	200	60	63	8	12	C	5.4	
FMR02-080-A27-RC20-04		●	10	80	27	50	10	4	A	0.7	
FMR02-080-A27-RC20-04C(FB)	*	●	10	80	27	50	10	4	A	0.7	
FMR02-100-B32-RC20-05		●	10	100	32	63	10	5	B	1.2	
FMR02-100-B32-RC20-06		●	10	100	32	63	10	6	B	1.2	RCKT2006
FMR02-100-B32-RC20-06C	*	○	10	100	32	63	10	6	B	1.2	
FMR02-125-B32-RC20-05		○	10	125	32	63	10	5	B	1.2	
FMR02-125-B40-RC20-06		●	10	125	40	63	10	6	B	1.2	

● Ex stock ○ On demand

* With internal cooling



System code > B26

Grade selection > B24

Technical info > B527





Cutting data > B230

Indexable milling

Article	*	Stock	Dimensions [mm]					Teeth	Coupling		Inserts 
			R	ØD	ød	L	a _p max				
FMR02-125-B40-RC20-07		●	10	125	40	63	10	7	B	2.2	RCKT2006
FMR02-125-B40-RC20-07C	*	○	10	125	40	63	10	7	B	2.2	
FMR02-160-B40-RC20-08		●	10	160	40	63	10	8	B	4.2	
FMR02-160-B40-RC20-08C	*	○	10	160	40	63	10	8	B	4.2	
FMR02-250-C60-RC20-10		●	10	250	60	63	10	10	C	8.49	
FMR02-250-C60-RC20-11		○	10	250	60	63	10	11	C	8.37	

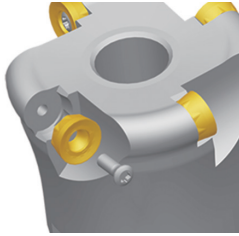
● Ex stock ○ On demand

* With internal cooling

Spare parts					
	Insert	RCGX1204 RCKT1204 RCMW1204	RCKT1606	RCKT2006	
	ØD	50-100	63-200	80-250	
	Screw (insert)	I60M3.5×10 (2.7 Nm)	I60M5×13 (6.7 Nm)	I43M6×16 (9.1 Nm)	
	Wrench (insert)	WT15IS			
	Wrench (insert)		WT20IT	WT25IT	

A

Turning

B

Milling

C

Drilling

D

Technical
Information

E

Index

System code > B26

Grade selection > B24

Technical info > B527

Cutting data > B230

A

Turning

B

Milling

C

Drilling

D

Technical Information

E

Index

RCKT	I.C	S	d
12 04	12	4.76	4
16 06	16	6.35	5.56
20 06	20	6.35	6.55

- Ideal machining conditions
- Normal machining conditions
- Unfavourable machining conditions

Milling inserts

RC** milling insert		HC ¹ (CVD)						HC ¹ (PVD)					HT	HC ²	HW								
		P	M	K	N	S	H																
		ISO																					
		YBC302	YBC301	YBC401	YBM253	YBM251	YBM351	YBD152	YBD252	YBG101	YBG102	YBG202	YBG212	YBS203	YBG205	YB9320	YBG302	YBS303	YBG252	YNG151	YNG151C	YD101	YD201
	RCKT1204MO-DM	○	○		○	●	○				○				●	○							
	RCKT1606MO-DM		○												●		●						
	RCKT2006MO-DM		○																				
	RCKT1204MO-DR		○	○		○	●								●								
	RCKT1606MO-DR		●	○	●		●	●								●							
	RCKT2006MO-DR		●	○	●		○	●			○						○						
	RCKT1204MO-ER				●																		
	RCKT1606MO-ER				●																		
	RCKT2006MO-ER				●																		
	RCKT1204MO-NM															○							
	RCKT1606MO-NM															○							

● Ex stock ○ On demand

HC¹ Coated carbide
 HT Uncoated cermet
 HC² Coated cermet
 HW Uncoated carbide



System code > B26

Grade selection > B24

Technical info > B527



Cutting data > B230



-  Ideal machining conditions
-  Normal machining conditions
-  Unfavourable machining conditions

RCGX	I.C	S	d
12 04	12	4.76	4

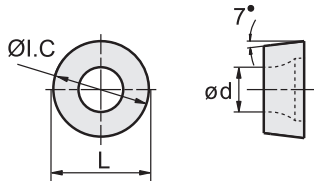
Milling inserts

RC** positive insert		HC ¹ (CVD)						HC ¹ (PVD)						HT	HC ²	HW								
	P																							
	M																							
	K																							
	N																							
	S																							
	H																							
ISO		YBC302	YBC301	YBC401	YBM253	YBM251	YBM351	YBD152	YBD252	YBG101	YBG102	YBG202	YBG212	YBS203	YBG205	YB9320	YBG302	YBS303	YBG252	YNG151	YNG151C	YD101	YD201	
	RCGX1204MO-LH																							●

● Ex stock ○ On demand

HC¹ Coated carbide
 HT Uncoated cermet
 HC² Coated cermet
 HW Uncoated carbide

A

Turning

B

Milling

C

Drilling

D

Technical Information

E

Index

System code > B26

Grade selection > B24

Technical info > B527

Cutting data > B230



Face milling

FMR03

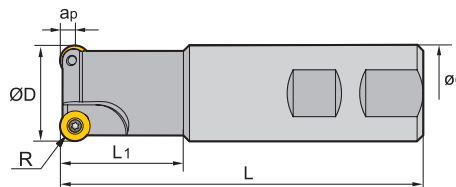
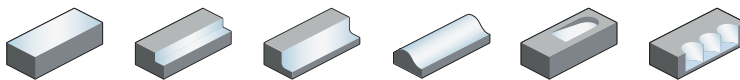

Article	*	Stock	Dimensions [mm]						Teeth	kg	Inserts
			R	ØD	ød	L ₁	L	a _{p max}			
FMR03-016-XP16-RD08-02		○	4	16	16	25	100	4	2	0.1	
FMR03-025-XP25-RD08-02		●	4	25	25	30	100	4	2	0.3	RD**0803
FMR03-025-XP25-RD08-02C	*	○	4	25	25	30	100	4	2	0.3	
FMR03-032-XP32-RD10-02		●	5	32	32	40	120	5	2	0.7	RD**10T3
FMR03-040-XP32-RD12-03		●	6	40	32	40	120	6	3	0.7	
FMR03-050-XP32-RD12-04		●	6	50	32	40	120	6	4	0.8	RD**1204

● Ex stock ○ On demand

* With internal cooling

Spare parts

Insert	ØD	RD**0803	RD**10T3	RD**1204	
		16-25	32	40-50	
Screw (insert)		I60M3×7 (1.8 Nm)	I60M4×10 (3.4 Nm)	I60M4×10 (3.4 Nm)	
Wrench (insert)		WT09IP	WT15IP	WT15IP	

System code > B26

Grade selection > B24

Technical info > B527

Cutting data > B230

Milling inserts

- Ideal machining conditions
- Normal machining conditions
- Unfavourable machining conditions

RDKT
10 T3
12 04

RD** milling insert		HC ¹ (CVD)						HC ¹ (PVD)					HT	HC ²	HW									
	P	●●●●●●●●	●●●●●●●●	●●●●●●●●	●●●●●●●●	●●●●●●●●	●●●●●●●●	●●●●●●●●	●●●●●●●●	●●●●●●●●	●●●●●●●●	●●●●●●●●	●●●●●●●●											
	M	●●●●●●●●	●●●●●●●●	●●●●●●●●	●●●●●●●●	●●●●●●●●	●●●●●●●●	●●●●●●●●	●●●●●●●●	●●●●●●●●	●●●●●●●●	●●●●●●●●	●●●●●●●●											
	K														●●●●●●●●									
	N														●●●●●●●●									
	S		●●●●●●●●	●●●●●●●●																				
	H																							
ISO		YBC302	YBC301	YBC401	YBM253	YBM251	YBM351	YBD152	YBD252	YBG101	YBG102	YBG202	YBG212	YBS203	YBG205	YB9320	YBG302	YBS303	YBG252	YNG151	YNG151C	YD101	YD201	
	RDKT10T3MO-MM																	○						
	RDKT1204MO-MM																	○						

● Ex stock ○ On demand

HC¹ Coated carbide
 HT Uncoated cermet
 HC² Coated cermet
 HW Uncoated carbide

Milling inserts

- Ideal machining conditions
- Normal machining conditions
- Unfavourable machining conditions

RDKW	I.C	S	d
08 03	8	3.18	3.4
10 T3	10	3.97	4.4
12 04	12	4.76	4.4

RD** milling insert		HC ¹ (CVD)						HC ¹ (PVD)					HT	HC ²	HW									
	P	●●●●●●●●	●●●●●●●●	●●●●●●●●	●●●●●●●●	●●●●●●●●	●●●●●●●●	●●●●●●●●	●●●●●●●●	●●●●●●●●	●●●●●●●●	●●●●●●●●	●●●●●●●●											
	M	●●●●●●●●	●●●●●●●●	●●●●●●●●	●●●●●●●●	●●●●●●●●	●●●●●●●●	●●●●●●●●	●●●●●●●●	●●●●●●●●	●●●●●●●●	●●●●●●●●	●●●●●●●●											
	K														●●●●●●●●									
	N														●●●●●●●●									
	S		●●●●●●●●	●●●●●●●●																				
	H																							
ISO		YBC302	YBC301	YBC401	YBM253	YBM251	YBM351	YBD152	YBD252	YBG101	YBG102	YBG202	YBG212	YBS203	YBG205	YB9320	YBG302	YBS303	YBG252	YNG151	YNG151C	YD101	YD201	
	RDKW0803MO						●																	
	RDKW10T3MO	●	○			○				●	○						○							
	RDKW1204MO	●				○	●			●	○			●	●		○							

● Ex stock ○ On demand

HC¹ Coated carbide
 HT Uncoated cermet
 HC² Coated cermet
 HW Uncoated carbide

Face milling

FMR03

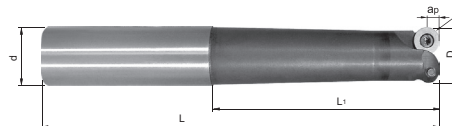
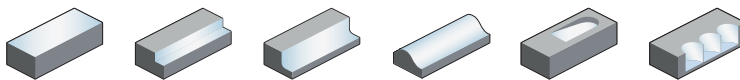

Article	*	Stock	Dimensions [mm]						Teeth	Inserts
			R	ØD	ød	L ₁	L	a _{p max}		
FMR03-015-G16-XS-RD0702-02		●	3.5	15	16	40	88	3.5	2	RDkW0702
FMR03-015-G16-XS-RD0702-02C	*	○	3.5	15	16	40	88	3.5	2	
FMR03-015-G16-S-RD0702-02		●	3.5	15	16	60	108	3.5	2	
FMR03-015-G16-S-RD0702-02C	*	○	3.5	15	16	60	108	3.5	2	
FMR03-015-G20-M-RD0702-02		●	3.5	15	20	80	130	3.5	2	
FMR03-015-G20-M-RD0702-02C	*	○	3.5	15	20	80	130	3.5	2	
FMR03-015-G25-XL-RD0702-02C	*	○	3.5	15	25	120	176	3.5	2	RDkW1003
FMR03-020-G20-XS-RD1003-02C	*	○	5	20	20	40	90	5	2	
FMR03-020-G20-S-RD1003-02C	*	○	5	20	20	60	110	5	2	
FMR03-020-G25-M-RD1003-02C	*	○	5	20	25	80	136	5	2	
FMR03-020-G25-L-RD1003-02C	*	○	5	20	25	100	156	5	2	
FMR03-020-G25-XL-RD1003-02C	*	○	5	20	25	120	176	5	2	

● Ex stock ○ On demand

* With internal cooling

Spare parts			
	Insert	RDkW0702	RDkW1003
	ØD	15	20
	Screw (insert)		I60M3.5x6.5TT (2.7Nm)
	Screw (insert)	I60M2.5x5.0 (1.0Nm)	
	Wrench (insert)		WT10IP
	Wrench (insert)	WT07P	

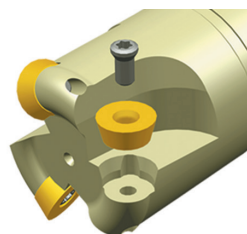



System code > B26

Grade selection > B24



Technical info > B527

Cutting data > B230

Milling inserts

-  Ideal machining conditions
-  Normal machining conditions
-  Unfavourable machining conditions

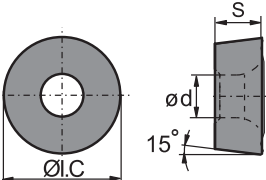
RDkW	I.C	S	d
07 02	7	2.38	2.7
10 03	10	3.18	3.9

RD** milling insert		HC ¹ (CVD)					HC ¹ (PVD)					HT	HC ²	HW											
	P																								
	M																								
	K																								
	N																								
	S																								
	H																								
ISO		YBC302	YBC301	YBC401	YBM253	YBM251	YBM351	YBD152	YBD252	YBG101	YBG102	YBG202	YBG212	YBS203	YBG205	YB9320	YBG302	YBS303	YBG252	YNG151	YNG151C	YD101	YD201		
	RDkW0702MO-1					●						○			●										
	RDkW0702MO-2									●															
	RDkW1003MO-1					○	●					○			●	●									
	RDkW1003MO-2										●														
	RDkW1003MO-3				●											●									

● Ex stock ○ On demand

Important information on the cutting edge design can be found on page B102.

HC¹ Coated carbide
 HT Uncoated cermet
 HC² Coated cermet
 HW Uncoated carbide

A
Turning

B
Milling

C
Drilling

D
Technical Information

E
Index



Face milling

FMR04

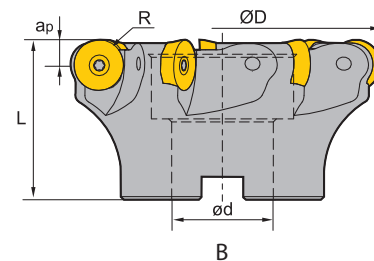
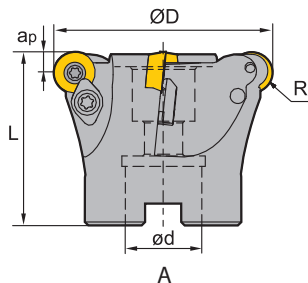
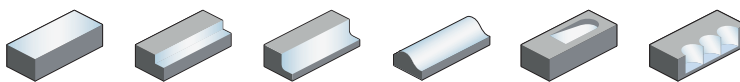

Article	*	Stock	Dimensions [mm]					Teeth	Coupling	kg	Inserts
			R	ØD	ød	L	a _{p max}				
FMR04-050-A22-RD12-03	●	●	6	50	22	40	6	3	A	0.3	RD**1204
FMR04-063-A22-RD12-04	●	●	6	63	22	50	6	4	A	0.5	
FMR04-080-B27-RD16-05	●	●	8	80	27	50	8	5	B	1.2	RD**1605
FMR04-100-B32-RD16-06	●	●	8	100	32	50	8	6	B	1	
FMR04-100-B32-RD20-06C	*	○	10	100	32	50	8	6	B	1	RD**2006
FMR04-125-B40-RD20-06	○	○	10	125	40	63	10	6	B	1.9	
FMR04-125-B40-RD20-06C	*	○	10	125	40	63	10	6	B	1.9	
FMR04-160-B40-RD20-07	○	○	10	160	40	63	10	7	B	3.7	

● Ex stock ○ On demand

* With internal cooling

Spare parts		RD**1204	RD**1605	RD**2006
	Insert	50-63	80-100	100-160
	Clamp	WD-204	WD-207	
	Screw (clamp)	I60M4×10 (3.4 Nm)	I60M5×13 (6.7 Nm)	
	Screw (insert)	I60M3.5×10 (2.7 Nm)	I60M5×13 (6.7 Nm)	I43M6×16 (9.1 Nm)
	Wrench (clamp)	WT15IP		
	Wrench (clamp)		WT20IT	
	Wrench (insert)	WT15IP		
	Wrench (insert)		WT20IT	WT25IT



System code > B26

Grade selection > B24

Technical info > B527

Cutting data > B230

RDKT
12 04

- Ideal machining conditions
- ⊗ Normal machining conditions
- ⊗ Unfavourable machining conditions

Milling inserts

RD** milling insert		HC ¹ (CVD)						HC ¹ (PVD)					HT	HC ²	HW									
	P	⊗	⊗	⊗	⊗	⊗	⊗	⊗	⊗	⊗	⊗	⊗	⊗	⊗										
	M	⊗	⊗	⊗	⊗	⊗	⊗	⊗	⊗	⊗	⊗	⊗	⊗	⊗										
	K							⊗	⊗	⊗	⊗	⊗	⊗	⊗	⊗									
	N							⊗	⊗	⊗	⊗	⊗	⊗	⊗	⊗									
	S							⊗	⊗	⊗	⊗	⊗	⊗	⊗	⊗									
	H																							
ISO		YBC302	YBC301	YBC401	YBM253	YBM251	YBM351	YBD152	YBD252	YBG101	YBG102	YBG202	YBG212	YBS203	YBG205	YB9320	YBG302	YBS303	YBG252	YNG151	YNG151C	YD101	YD201	
	RDKT1204MO-MM																	○						

● Ex stock ○ On demand

HC¹ Coated carbide
HT Uncoated cermet
HC² Coated cermet
HW Uncoated carbide

A
Turning

B
Milling

- Ideal machining conditions
- ⊗ Normal machining conditions
- ⊗ Unfavourable machining conditions

RDKW	I.C	S	d
12 04	12	4.76	4.4
16 05	16	5.56	5.5
20 06	20	6.35	6.5

Milling inserts

RD** milling insert		HC ¹ (CVD)						HC ¹ (PVD)					HT	HC ²	HW									
	P	⊗	⊗	⊗	⊗	⊗	⊗	⊗	⊗	⊗	⊗	⊗	⊗	⊗										
	M	⊗	⊗	⊗	⊗	⊗	⊗	⊗	⊗	⊗	⊗	⊗	⊗	⊗										
	K							⊗	⊗	⊗	⊗	⊗	⊗	⊗	⊗									
	N							⊗	⊗	⊗	⊗	⊗	⊗	⊗	⊗									
	S							⊗	⊗	⊗	⊗	⊗	⊗	⊗	⊗									
	H																							
ISO		YBC302	YBC301	YBC401	YBM253	YBM251	YBM351	YBD152	YBD252	YBG101	YBG102	YBG202	YBG212	YBS203	YBG205	YB9320	YBG302	YBS303	YBG252	YNG151	YNG151C	YD101	YD201	
	RDKW1204MO	●									●	○			●	●	○							
	RDKW1605MO											○	○				○							
	RDKW2006MO																							
	RDKW2006MO-3														●									

● Ex stock ○ On demand

Important information on the cutting edge design can be found on page B102.

HC¹ Coated carbide
HT Uncoated cermet
HC² Coated cermet
HW Uncoated carbide

C
Drilling

D
Technical Information

E
Index



Face milling

FMR04

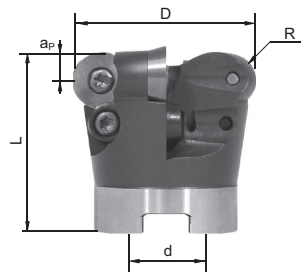
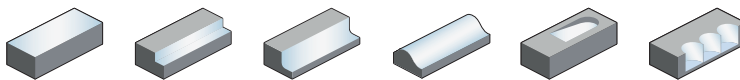

Article	*	Stock	Dimensions [mm]					Teeth	Inserts
			R	ØD	ød	L	a _p max		
FMR04-042-A16-RD1003-06		○	5	42	16	44	5	6	RDKW1003
FMR04-042-A16-RD1003-06C	*	●	5	42	16	44	5	6	
FMR04-052-A22-RD1003-07		○	5	52	22	50	5	7	
FMR04-052-A22-RD1003-07C	*	●	5	52	22	50	5	7	RDKW12T3
FMR04-042-A16-RD12T3-05		○	6	42	16	42	6	5	
FMR04-042-A16-RD12T3-05C	*	●	6	42	16	42	6	5	
FMR04-052-A22-RD12T3-05		○	6	52	22	50	6	5	RDKW12T3
FMR04-052-A22-RD12T3-05C	*	●	6	52	22	50	6	5	
FMR04-066-A27-RD12T3-06		○	6	66	27	50	6	6	
FMR04-066-A27-RD12T3-06C	*	●	6	66	27	50	6	6	RDKW1604
FMR04-080-A27-RD12T3-07		○	6	80	27	50	6	7	
FMR04-080-A27-RD12T3-07C	*	●	6	80	27	50	6	7	
FMR04-052-A22-RD1604-04		○	8	52	22	50	8	4	RDKW1604
FMR04-052-A22-RD1604-04C	*	●	8	52	22	50	8	4	
FMR04-066-A27-RD1604-05		○	8	66	27	50	8	5	
FMR04-066-A27-RD1604-05C	*	●	8	66	27	50	8	5	
FMR04-080-A27-RD1604-06		○	8	80	27	52	8	6	
FMR04-080-A27-RD1604-06C	*	●	8	80	27	52	8	6	
FMR04-100-B32-RD1604-07		○	8	100	32	52	8	7	
FMR04-100-B32-RD1604-07C	*	●	8	100	32	52	8	7	
FMR04-125-B40-RD1604-08		○	8	125	40	52	8	8	
FMR04-160-B40-RD1604-09		○	8	160	40	52	8	9	
FMR04-160-B40-RD1604-09C	*	●	8	160	40	52	8	9	

● Ex stock ○ On demand

* With internal cooling

System code > B26

Grade selection > B24

Technical info > B527

Cutting data > B230

Spare parts						
	Insert	RDKW1003	RDKW12T3	RDKW12T3	RDKW1604	RDKW1604
	ØD	42-52	42	52-80	52	66-160
	Clamp					WX16N
	Clamp			LOM3.5x7.1		
	Screw (clamp)					I60M4.5x10 (5.0 Nm)
	Screw (insert)	I60M3.5x6.5TT (2.7 Nm)				
	Screw (insert)		I60M3.5x7.7 (2.7 Nm)	I60M3.5x7.7 (2.7 Nm)	I60M4.5x10 (5.0 Nm)	I60M4.5x10 (5.0 Nm)
	Wrench (clamp)			WT15P		
	Wrench (clamp)					WT20T
	Wrench (insert)	WT10IP				
	Wrench (insert)		WT15P	WT15P		
	Wrench (insert)				WT20T	WT20T

RDKW	I.C	S	d
10 03	10	3.18	3.9
12 T3	12	3.97	3.9
16 04	16	4.76	5.2

- Ideal machining conditions
- Normal machining conditions
- Unfavourable machining conditions

Milling inserts

RD** milling insert	HC ¹ (CVD)						HC ¹ (PVD)						HT	HC ²	HW							
	P	M	K	N	S	H	P	M	K	N	S	H										
ISO	YBC302	YBC301	YBC401	YBM253	YBM251	YBM351	YBD152	YBD252	YBG101	YBG102	YBG202	YBG212	YBS203	YBG205	YB9320	YBG302	YBS303	YBG252	YNG151	YNG151C	YD101	YD201
	RDKW1003MO-1				○	●					○			●	●							
	RDKW1003MO-2								●													
	RDKW1003MO-3			●										●								
	RDKW12T3MO-1				○	●					○			●	●							
	RDKW12T3MO-2								●					○								
	RDKW12T3MO-3			●										●								
	RDKW1604MO-1					●				○				●	●	●						
	RDKW1604MO-2									○												
	RDKW1604MO-3	○		●			●		○					●		●						

● Ex stock ○ On demand

Important information on the cutting edge design can be found on page B102.

HC¹ Coated carbide
 HT Uncoated cermet
 HC² Coated cermet
 HW Uncoated carbide

IMPORTANT INFORMATION

Cutting edge design RDKW

RDKW*MO-1

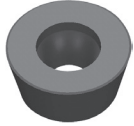

General machining

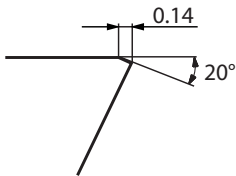

RDKW*MO-2

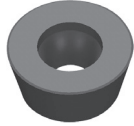

Soft cutting geometry
(Finishing)

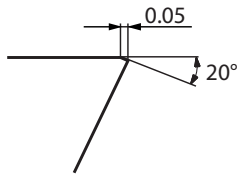

RDKW*MO-3

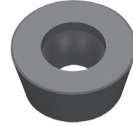

Roughing

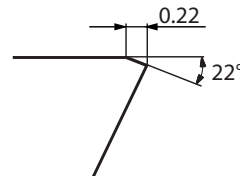
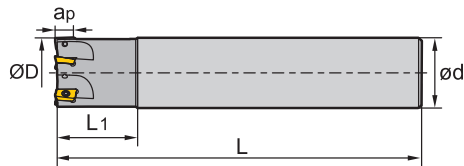
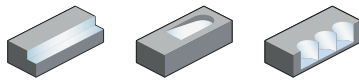

Fig.: FMR04-052-B22-RD12T3-05C

Square shoulder milling

EMP01 Kr: 90°



Straight shank

Article	*	Stock	Dimensions [mm]					Teeth	kg	Inserts
			$\varnothing D$	$\varnothing d$	L_1	L	$a_{p \max}$			
EMP01-012-G12-AP07-02C	*	●	12	12	25	75	6.4	2	0.31	APKT0702
EMP01-014-G16-AP07-03C	*	●	14	16	25	85	6.4	3	0.61	
EMP01-016-G16-AP07-04C	*	●	16	16	30	90	6.4	4	0.75	
EMP01-012-G16-AP11-01		●	12	16	25	85	10.5	1	0.1	APKT11T3
EMP01-016-G16-AP11-02		●	16	16	25	90	10.5	2	0.1	
EMP01-016-G16-AP11-02C	*	○	16	16	25	90	10.5	2	0.1	
EMP01-020-G20-AP11-02		●	20	20	30	100	10.5	2	0.2	
EMP01-020-G20-AP11-02C	*	●	20	20	30	100	10.5	2	0.2	
EMP01-020-G20-AP11-03		○	20	20	30	100	10.5	3	0.2	
EMP01-020-G20-AP11-03C	*	●	20	20	30	100	10.5	3	0.2	
EMP01-025-G25-AP11-03		●	25	25	35	115	10.5	3	0.4	
EMP01-025-G25-AP11-03C	*	○	25	25	35	115	10.5	3	0.4	
EMP01-025-G25-AP11-04		●	25	25	35	115	10.5	4	0.4	
EMP01-025-G25-AP11-04C	*	●	25	25	35	115	10.5	4	0.4	
EMP01-032-G32-AP11-04		●	32	32	40	125	10.5	4	0.7	APKT1604
EMP01-025-G25-AP16-02		●	25	25	35	115	15.5	2	0.4	
EMP01-025-G25-AP16-02C	*	●	25	25	35	115	15.5	2	0.4	
EMP01-032-G32-AP16-03		●	32	32	40	125	15.5	3	0.7	
EMP01-032-G32-AP16-03C	*	●	32	32	40	125	15.5	3	0.7	
EMP01-040-G32-AP16-03		●	40	32	42	130	15.5	3	0.7	
EMP01-040-G32-AP16-03C	*	●	40	32	42	130	15.5	3	0.7	
EMP01-040-G32-AP16-04C	*	○	40	32	42	130	15.5	4	0.8	
EMP01-050-G32-AP16-05		●	50	32	45	135	15.5	5	1	
EMP01-063-G32-AP16-06		●	63	32	45	135	15.5	6	1.4	

● Ex stock ○ On demand

* With internal cooling

System code > B26

Grade selection > B24

Technical info > B527

Cutting data > B230



Indexable milling Square shoulder milling

A

Turning

Spare parts		APKT0702	APKT11T3	APKT1604
Insert		12-25	12-32	25-63
ØD				
	Screw (insert)	I60M1.8×4 (0.5 Nm)		I60M4×8.4 (3.4 Nm)
	Screw (insert)		I60M2.5×6.5T (1.0 Nm)	
	Wrench (insert)	WT05IP	WT08IP	
	Wrench (insert)			WT15S

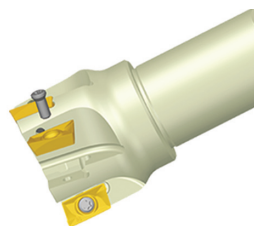

B

Milling

Milling inserts

- Ideal machining conditions
- Normal machining conditions
- Unfavourable machining conditions

APKT	L	S	d
07 02	4.26	2.38	2
11 T3	12.24	3.6	2.8
16 04	17.877	5.76	4.4

C

Drilling

AP** milling insert		HC ¹ (CVD)						HC ¹ (PVD)				HT	HC ²	HW												
ISO		r	I.W	YBC302	YBC301	YBC401	YBM253	YBM251	YBM351	YBD152	YBD252	YBG101	YBG102	YBG202	YBG212	YBS203	YBG205	YB9320	YBG302	YBS303	YBG252	YNG151	YNG151C	YD101	YD201	
	APKT11T304-ALH	0.4	6.5									●													●	●
	APKT11T308-ALH	0.8	6.5									●													●	●
	APKT160408-ALH	0.8	9.33									●													●	●
	APKT11T304-APF	0.4	6.5																							
	APKT11T308-APF	0.8	6.5													○				●						
	APKT160408-APF	0.8	9.33													○				●						
	APKT070204-APM	0.4	6.91																							
	APKT11T304-APM	0.4	6.5				●			●																
	APKT11T308-APM	0.8	6.5				●			●					○					●						○
	APKT11T312-APM	1.2	6.5				●			●										●						
	APKT11T316-APM	1.6	6.5				●			●										●						
	APKT11T320-APM	2	6.5				●			●										●						
	APKT160408-APM	0.8	9.33				●			●	●				○					●						○
	APKT160416-APM	1.6	9.33				●			●										●						
	APKT160420-APM	2	9.33				●			●										●						
	APKT160424-APM	2.4	9.33				●			●										●						
	APKT160430-APM	3	9.33				●			●										●						
	APKT11T304-LH	0.4	6.5																							○ ○
	APKT11T308-LH	0.8	6.5																							○ ●
	APKT160408-LH	0.8	9.33																							○ ○

● Ex stock ○ On demand

HC¹ Coated carbide
HT Uncoated cermet
HC² Coated cermet
HW Uncoated carbide

D

Technical Information

E

Index



System code > B26

Grade selection > B24







Technical info > B527

Cutting data > B230

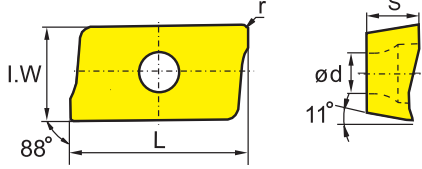
Milling inserts

-  Ideal machining conditions
-  Normal machining conditions
-  Unfavourable machining conditions

APKT	L	S	d
07 02	4.26	2.38	2
11 T3	12.24	3.6	2.8
16 04	17.877	5.76	4.4

AP** milling insert			HC ¹ (CVD)						HC ¹ (PVD)					HT	HC ²	HW											
			P	M	K	N	S	H																			
																											
ISO			r	I.W	YBC302	YBC301	YBC401	YBM253	YBM251	YBM351	YBD152	YBD252	YBG101	YBG102	YBG202	YBG212	YBS203	YBG205	YB9320	YBG302	YBS303	YBG252	YNG151	YNG151C	YD101	YD201	
	APKT11T308-NM																										
	APKT11T312-NM																										
	APKT11T304-PF	0.4	6.5	○	○								○	○					○								
	APKT11T308-PF	0.8	6.5												○												
	APKT11T316-PF	1.6	6.5												○												
	APKT160408-PF	0.8	9.33	○	○										○				○								
	APKT160430-PF	3	9.33	○																							
	APKT11T304-PM	0.4	6.5	○	○	○	○	○	○				○	○					○								
	APKT11T308-PM	0.8	6.5	○	○	○	○	●	○	○			○	○					○	○							
	APKT11T312-PM	1.2	6.5				○								○												
	APKT11T316-PM	1.6	6.5				○								○												
	APKT160408-PM	0.8	9.33	○	○	○	●	●	○	○			○	○					○	●							
	APKT160416-PM	1.6	9.33	○											○												
	APKT11T304-PR	0.4	6.5					○											○								
	APKT11T316-PR	1.6	6.5																○								
	APKT11T3XR																										

● Ex stock ○ On demand

HC¹ Coated carbide
 HT Uncoated cermet
 HC² Coated cermet
 HW Uncoated carbide

Square shoulder milling

EMP01 Kr: 90°

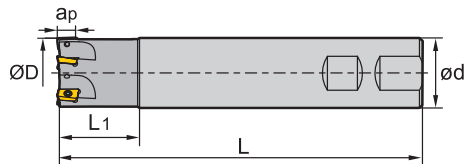
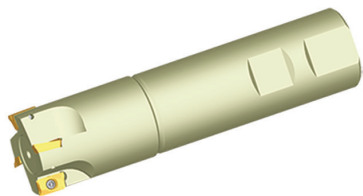
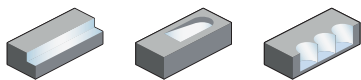

Weldon shank

Article	*	Stock	Dimensions [mm]					Teeth	kg	Inserts
			ØD	ød	L ₁	L	a _{p max}			
EMP01-020-XP20-AP07-05C	*	●	20	20	30	100	6.4	5	0.31	APKT0702
EMP01-025-XP25-AP07-07C	*	●	25	25	35	115	6.4	7	0.61	
EMP01-012-XP16-AP11-01		●	12	16	25	85	10.5	1	0.1	APKT11T3
EMP01-012-XP16-AP11-01C	*	○	12	16	25	85	10.5	1	0.1	
EMP01-016-XP16-AP11-02		●	16	16	25	90	10.5	2	0.1	
EMP01-016-XP16-AP11-02C	*	○	16	16	25	90	10.5	2	0.1	
EMP01-020-XP20-AP11-02		●	20	20	30	100	10.5	2	0.2	
EMP01-020-XP20-AP11-02C	*	○	20	20	30	100	10.5	2	0.2	
EMP01-020-XP20-AP11-03		●	20	20	30	100	10.5	3	0.2	
EMP01-020-XP20-AP11-03C	*	●	20	20	30	100	10.5	3	0.2	
EMP01-025-XP25-AP11-03		●	25	25	35	115	10.5	3	0.4	
EMP01-025-XP25-AP11-03C	*	●	25	25	35	115	10.5	3	0.4	
EMP01-025-XP25-AP11-04		●	25	25	35	115	10.5	4	0.4	APKT1604
EMP01-025-XP25-AP11-04C	*	○	25	25	35	115	10.5	4	0.4	
EMP01-032-XP32-AP11-04		●	32	32	40	125	10.5	4	0.7	
EMP01-032-XP32-AP11-04C	*	○	32	32	40	125	10.5	4	0.7	
EMP01-025-XP25-AP16-02		●	25	25	35	115	15.5	2	0.4	
EMP01-025-XP25-AP16-02C	*	○	25	25	35	115	15.5	2	0.4	
EMP01-032-XP32-AP16-03		●	32	32	40	125	15.5	3	0.7	
EMP01-032-XP32-AP16-03C	*	○	32	32	40	125	15.5	3	0.7	
EMP01-040-XP32-AP16-04		●	40	32	42	130	15.5	4	0.8	
EMP01-040-XP32-AP16-04C	*	○	40	32	42	130	15.5	4	0.8	
EMP01-050-XP32-AP16-05		●	50	32	45	135	15.5	5	1	APKT1604
EMP01-063-XP32-AP16-06		○	63	32	45	135	15.5	6	1.4	

● Ex stock ○ On demand





* With internal cooling

System code > B26

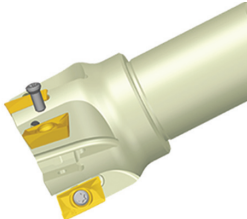

Grade selection > B24

Technical info > B527





Cutting data > B230

Spare parts				
Insert	APKT0702	APKT11T3	APKT1604	
ØD	12-25	12-32	25-63	
 Screw (insert)	I60M1.8x4 (0.5 Nm)		I60M4x8.4 (3.4 Nm)	
 Screw (insert)		I60M2.5x6.5T (1.0Nm)		
 Wrench (insert)	WT05IP	WT08IP		
 Wrench (insert)			WT15S	

Milling inserts

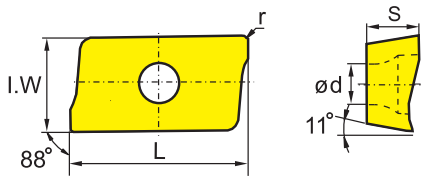
-  Ideal machining conditions
-  Normal machining conditions
-  Unfavourable machining conditions

APKT	L	S	d
07 02	4.26	2.38	2
11 T3	12.24	3.6	2.8
16 04	17.877	5.76	4.4

AP** milling insert				HC ¹ (CVD)						HC ¹ (PVD)						HT	HC ²	HW								
		P	M	K	N	S	H																			
																										
ISO		r	I.W	YBC302	YBC301	YBC401	YBM253	YBM251	YBM351	YBD152	YBD252	YBG101	YBG102	YBG202	YBG212	YBS203	YBG205	YB9320	YBG302	YBS303	YBG252	YNG151	YNG151C	YD101	YD201	
	APKT11T304-ALH	0.4	6.5									●													●	●
	APKT11T308-ALH	0.8	6.5									●													●	●
	APKT160408-ALH	0.8	9.33									●													●	●
	APKT11T304-APF	0.4	6.5															●								
	APKT11T308-APF	0.8	6.5												○			●		○						
	APKT160408-APF	0.8	9.33												○			●		○						
	APKT070204-APM	0.4	6.91															●								
	APKT11T304-APM	0.4	6.5				●		●									●								
	APKT11T308-APM	0.8	6.5				●		●					○				●		○						
	APKT11T312-APM	1.2	6.5				●		●									●								
	APKT11T316-APM	1.6	6.5				●		●									●								
	APKT11T320-APM	2	6.5				●		●									●								
	APKT160408-APM	0.8	9.33				●		●	●				○				●		○						
	APKT160416-APM	1.6	9.33				●		●									●								
	APKT160420-APM	2	9.33				●		●									●								
	APKT160424-APM	2.4	9.33				●		●									●								
	APKT160430-APM	3	9.33				●											●								
	APKT11T304-LH	0.4	6.5																						○	○
	APKT11T308-LH	0.8	6.5																						○	●
	APKT160408-LH	0.8	9.33																						○	○

● Ex stock ○ On demand

HC¹ Coated carbide
 HT Uncoated cermet
 HC² Coated cermet
 HW Uncoated carbide

A

Turning

B

Milling

C

Drilling

D

Technical Information

E

Index

Indexable milling Square shoulder milling

A

Turning

B

Milling

C

Drilling

D

Technical Information





E

Index

- Ideal machining conditions
- ⊗ Normal machining conditions
- ⊗ Unfavourable machining conditions

APKT	L	S	d
07 02	4.26	2.38	2
11 T3	12.24	3.6	2.8
16 04	17.877	5.76	4.4

Milling inserts

AP** milling insert				HC ¹ (CVD)						HC ¹ (PVD)						HT	HC ²	HW										
				P																								
				M																								
				K																								
				N																								
				S																								
				H																								
ISO				r	I.W	YBC302	YBC301	YBC401	YBM253	YBM251	YBM351	YBD152	YBD252	YBG101	YBG102	YBG202	YBG212	YBS203	YBG205	YB9320	YBG302	YBS303	YBG252	YNG151	YNG151C	YD101	YD201	
	APKT11T308-NM																											
	APKT11T312-NM																											
	APKT11T304-PF	0.4	6.5			○								○	○						○							
	APKT11T308-PF	0.8	6.5													○												
	APKT11T316-PF	1.6	6.5													○												
	APKT160408-PF	0.8	9.33			○										○					○							
	APKT160430-PF	3	9.33			○																						
	APKT11T304-PM	0.4	6.5			○	○	○		○	○			○	○						○							
	APKT11T308-PM	0.8	6.5			○	○		○	○	●	○	○	○	○						○							
	APKT11T312-PM	1.2	6.5													○					○							
	APKT11T316-PM	1.6	6.5													○					○							
	APKT160408-PM	0.8	9.33			○	○	○	●	●	○	○		○	○						○	●						
	APKT160416-PM	1.6	9.33			○									○													
	APKT11T304-PR	0.4	6.5																		○							
	APKT11T316-PR	1.6	6.5																		○							
	APKT11T3XR																											

● Ex stock ○ On demand

HC¹ Coated carbide
 HT Uncoated cermet
 HC² Coated cermet
 HW Uncoated carbide



Square shoulder milling

EMP02 Kr: 90°

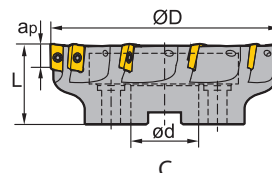
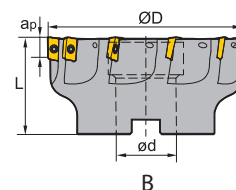
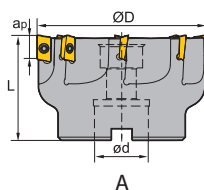
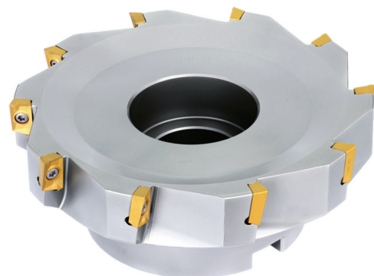
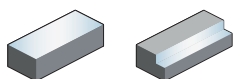

Article	*	Stock	Dimensions [mm]				Teeth	Coupling	kg	Inserts
			ØD	ød	L	ap max				
EMP02-032-A16-AP07-08C	*	●	32	16	35	6.4	8	A	0.34	APKT0702
EMP02-040-A16-AP07-10C	*	●	40	16	40	6.4	10	A	0.4	
EMP02-050-A22-AP07-12C	*	●	50	22	40	6.4	12	A	0.6	
EMP02-040-A16-AP11-04C	*	●	40	16	40	11	4	A	0.237	
EMP02-040-A16-AP11-05C	*	●	40	16	40	11	5	A	0.177	
EMP02-040-A16-AP11-06C	*	●	40	16	40	11	6	A	0.234	
EMP02-050-A22-AP11-06		●	50	22	40	11	6	A	0.3	APKT11T3
EMP02-050-A22-AP11-06C	*	●	50	22	40	11	6	A	0.3	
EMP02-050-A22-AP11-07C	*	●	50	22	40	11	7	A	0.39	
EMP02-063-A22-AP11-08		●	63	22	40	11	8	A	0.6	
EMP02-063-A22-AP11-08C	*	●	63	22	40	11	8	A	0.6	
EMP02-063-A22-AP11-09C	*	●	63	22	40	11	9	A	0.54	
EMP02-080-A27-AP11-08		●	80	27	50	11	8	A	1.2	
EMP02-080-A27-AP11-08C	*	●	80	27	50	11	8	A	1.2	
EMP02-080-A27-AP11-10C	*	●	80	27	50	11	10	A	1.13	
EMP02-100-B32-AP11-10		●	100	32	50	11	10	B	1.7	
EMP02-100-B32-AP11-10C	*	○	100	32	50	11	10	B	1.7	
EMP02-125-B40-AP11-10		○	125	40	63	11	10	B	3.42	
EMP02-040-A16-AP16-03		○	40	16	40	15.5	3	A	0.17	APKT1604
EMP02-040-A16-AP16-04C	*	●	40	16	40	15.5	4	A	0.17	
EMP02-050-A22-AP16-05		●	50	22	40	15.5	5	A	0.3	
EMP02-050-A22-AP16-05C	*	●	50	22	40	15.5	5	A	0.3	
EMP02-063-A22-AP16-06		●	63	22	40	15.5	6	A	0.5	
EMP02-063-A22-AP16-06C	*	●	63	22	40	15.5	6	A	0.5	
EMP02-080-A27-AP16-06C	*	○	80	27	50	15.5	6	A	1.08	
EMP02-080-A27-AP16-07		●	80	27	50	15.5	7	A	1.1	
EMP02-080-A27-AP16-07C	*	●	80	27	50	15.5	7	A	1.1	
EMP02-100-B32-AP16-08		●	100	32	50	15.5	8	B	1.6	

● Ex stock ○ On demand

* With internal cooling

System code > B26

Grade selection > B24

Technical info > B527

Cutting data > B230



A

Turning

B

Milling

C

Drilling

D

Technical Information

E

Index

Indexable milling

A

Turning

B

Milling

C



Drilling

D

Technical Information





E

Index

Article	*	Stock	Dimensions [mm]				Teeth	Coupling		Inserts 
			ØD	ød	L	a _{p max}				
EMP02-100-B32-AP16-08C	*	●	100	32	50	15.5	8	B	1.6	APKT1604
EMP02-125-B40-AP16-06C	*	○	125	40	63	15.5	6	B	3.18	
EMP02-125-B40-AP16-10		○	125	40	63	15.5	10	B	3.2	
EMP02-125-B40-AP16-10C	*	○	125	40	63	15.5	10	B	3.2	
EMP02-160-B40-AP16-07C	*	○	160	40	63	15.5	7	B	4.3	
EMP02-160-B40-AP16-10		○	160	40	63	15.5	10	B	6.3	
EMP02-160-B40-AP16-10C	*	○	160	40	63	15.5	10	B	6.3	
EMP02-200-C60-AP16-12		○	200	60	63	15.5	12	C	8.1	
EMP02-250-C60-AP16-12		○	250	60	63	15.5	12	C	11.2	

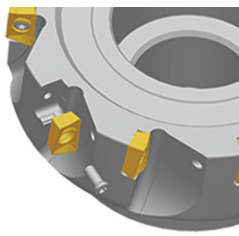
● Ex stock ○ On demand

* With internal cooling

Spare parts					
	Insert	APKT11T3	APKT1604	APKT1604	
	ØD	40-125	40-160	160-250	
	Cassette			Locator-APKT16	
	Screw (insert)		I60M4×10 (3.4 Nm)	I60M4×10 (3.4 Nm)	
	Screw (insert)	I60M2.5×6.5T (1.0Nm)			
	Wrench (insert)	WT08IS	WT15IS	WT15IS	



System code > B26

Grade selection > B24

Technical info > B527





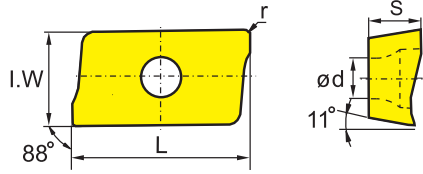

Cutting data > B230

APKT	L	S	d
07 02	4.26	2.38	2
11 T3	12.24	3.6	2.8
16 04	17.877	5.76	4.4

-  Ideal machining conditions
-  Normal machining conditions
-  Unfavourable machining conditions

Milling inserts



APKT** milling insert			HC ¹ (CVD)						HC ¹ (PVD)					HT	HC ²	HW								
			P	M	K	N	S	H																
ISO	r	I.W	YBC302	YBC301	YBC401	YBM253	YBM251	YBM351	YBD152	YBD252	YBG101	YBG102	YBG202	YBG212	YBS203	YBG205	YBG320	YBG302	YBS303	YBG252	YNG151	YNG151C	YD101	YD201
	0.4	6.5									●													● ●
APKT11T308-ALH	0.8	6.5									●													● ●
APKT160408-ALH	0.8	9.33									●													● ●
	0.4	6.5														●								
APKT11T308-APF	0.8	6.5												○		●		○						
APKT160408-APF	0.8	9.33												○		●	○	○						
APKT070204-APM	0.4	6.91														●								
APKT11T304-APM	0.4	6.5				●		●								●								
APKT11T308-APM	0.8	6.5				●		●					○		●		○							
APKT11T312-APM	1.2	6.5				●		●							●									
APKT11T316-APM	1.6	6.5				●		●							●									
	2	6.5				●		●							●									
APKT160408-APM	0.8	9.33				●		● ●					○		●		○							
APKT160416-APM	1.6	9.33				●		●							●									
APKT160420-APM	2	9.33				●		●							●									
APKT160424-APM	2.4	9.33				●		●							●									
APKT160430-APM	3	9.33				●									●									
	0.4	6.5																					○ ○	
APKT11T308-LH	0.8	6.5																					○ ●	
APKT160408-LH	0.8	9.33																					○ ○	
															●		●							
APKT11T312-NM														●		●								
	0.4	6.5	○	○							○ ○						○							
APKT11T308-PF	0.8	6.5										○												
APKT11T316-PF	1.6	6.5										○												
APKT160408-PF	0.8	9.33	○					○				○						○						
APKT160430-PF	3	9.33	○																					
	0.4	6.5	○ ○ ○	○ ○							○ ○						○							
APKT11T308-PM	0.8	6.5	○ ○	○ ○	● ○ ○						○ ○					○	○							
APKT11T312-PM	1.2	6.5				○					○ ○						○							
APKT11T316-PM	1.6	6.5				○					○ ○						○							
APKT160408-PM	0.8	9.33	○ ○ ○ ●	● ○ ○							○ ○					○	●							
APKT160416-PM	1.6	9.33	○									○												

● Ex stock ○ On demand

HC¹ Coated carbide
 HT Uncoated cermet
 HC² Coated cermet
 HW Uncoated carbide



A Turning
B Milling
C Drilling
D Technical Information
E Index

A

Turning

B

Milling

C

Drilling

D

Technical Information

E

Index

APKT	L	S	d
07 02	4.26	2.38	2
11 T3	12.24	3.6	2.8
16 04	17.877	5.76	4.4

- Ideal machining conditions
- Normal machining conditions
- Unfavourable machining conditions

Milling inserts

AP** milling insert				HC ¹ (CVD)						HC ¹ (PVD)						HT	HC ²	HW										
				P	M	K	N	S	H																			
ISO				r	I.W	YBC302	YBC301	YBC401	YBM253	YBM251	YBM351	YBD152	YBD252	YBG101	YBG102	YBG202	YBG212	YBS203	YBG205	YB9320	YBG302	YBS303	YBG252	YNG151	YNG151C	YD101	YD201	
	APKT11T304-PR			0.4	6.5																							
	APKT11T316-PR			1.6	6.5																							
	APKT11T3XR																											

● Ex stock ○ On demand

HC¹ Coated carbide
 HT Uncoated cermet
 HC² Coated cermet
 HW Uncoated carbide

System code > B26

Grade selection > B24

Technical info > B527

Cutting data > B230



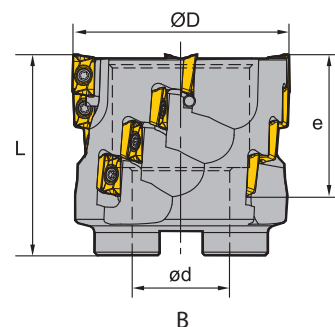
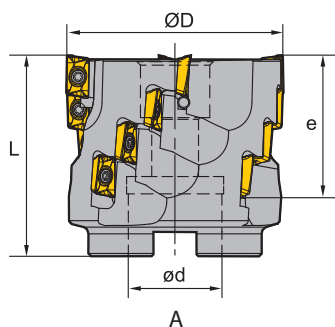
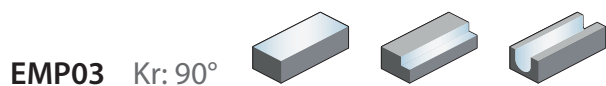

Square shoulder milling



Article	*	Stock	Dimensions [mm]				Teeth	Coupling	No. of inserts	kg	Inserts
			ØD	e	ød	L					
EMP03-050-A22-AP11-04	●	○	50	39	22	58	4	A	16	0.5	 APKT11T3
EMP03-050-A22-AP11-04C	*	○	50	39	22	58	4	A	16	0.5	
EMP03-063-A27-AP11-04	●	○	63	39	27	58	4	A	16	0.9	
EMP03-063-A27-AP11-04C	*	○	63	39	27	58	4	A	16	0.9	
EMP03-080-B32-AP11-05	●	○	80	39	32	63	5	B	20	1.3	
EMP03-080-B32-AP11-05C	*	○	80	39	32	63	5	B	20	1.3	
EMP03-100-B40-AP11-06	●	○	100	39	40	63	6	B	24	2	
EMP03-100-B40-AP11-06C	*	○	100	39	40	63	6	B	24	2	

● Ex stock ○ On demand

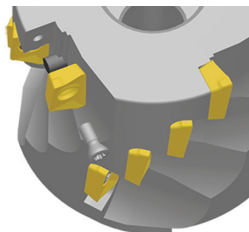
* With internal cooling

Spare parts			
	Insert ØD	APKT11T3 50-100	
	Screw (insert)	I60M2.5x6.5T (1.0Nm)	
	Wrench (insert)	WT08IS	

A

Turning

B

Milling

C

Drilling

D

Technical
Information

E

Index

Indexable milling Square shoulder milling

A

Turning

- Ideal machining conditions
- ⊗ Normal machining conditions
- ⊗ Unfavourable machining conditions

APKT	L	S	d
11 T3	12.24	3.6	2.8

Milling inserts

AP** milling insert		HC ¹ (CVD)						HC ¹ (PVD)					HT	HC ²	HW	
	P	⊗	⊗	⊗	⊗	⊗	⊗	⊗	⊗	⊗	⊗	⊗	⊗	⊗	⊗	
	M	⊗	⊗	⊗	⊗	⊗	⊗	⊗	⊗	⊗	⊗	⊗	⊗	⊗	⊗	
	K								⊗	⊗					⊗	
	N								⊗						⊗	⊗
	S		⊗	⊗					⊗	⊗	⊗	⊗	⊗			
	H															

B

Milling

ISO	r	I.W	Milling insert grades																					
			YBC302	YBC301	YBC401	YBM253	YBM251	YBM351	YBD152	YBD252	YBG101	YBG102	YBG202	YBG212	YBS203	YBG205	YB9320	YBG302	YBS303	YBG252	YNG151	YNG151C	YD101	YD201
	APKT11T304-ALH	0.4	6.5							●													●	●
	APKT11T308-ALH	0.8	6.5							●													●	●
	APKT11T304-APF	0.4	6.5													●								
	APKT11T308-APF	0.8	6.5										○			●		○						
	APKT11T304-APM	0.4	6.5				●		●							●								
	APKT11T308-APM	0.8	6.5				●		●				○			●		○						
	APKT11T312-APM	1.2	6.5				●		●							●								
	APKT11T316-APM	1.6	6.5				●		●							●								
	APKT11T320-APM	2	6.5				●		●							●								
	APKT11T304-LH	0.4	6.5																				○	○
	APKT11T308-LH	0.8	6.5																				○	●
	APKT11T308-NM															●								
	APKT11T312-NM															●								
	APKT11T304-PF	0.4	6.5		○		○				○	○					○							
	APKT11T308-PF	0.8	6.5									○												
	APKT11T316-PF	1.6	6.5									○												
	APKT11T304-PM	0.4	6.5	○	○	○		○	○			○	○				○							
	APKT11T308-PM	0.8	6.5	○	○		○	○	●	○	○		○	○		○	○							
	APKT11T312-PM	1.2	6.5					○				○	○				○							
	APKT11T316-PM	1.6	6.5					○				○	○				○							
	APKT11T304-PR	0.4	6.5														○							
	APKT11T316-PR	1.6	6.5														○							
	APKT11T3XR									●							●							

C

Drilling

D

Technical Information

E

Index

● Ex stock ○ On demand

HC¹ Coated carbide
 HT Uncoated cermet
 HC² Coated cermet
 HW Uncoated carbide



Square shoulder milling

EMP04 Kr: 90°

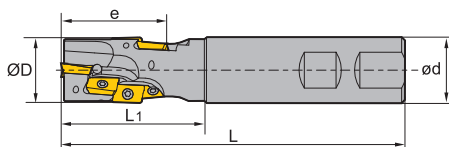
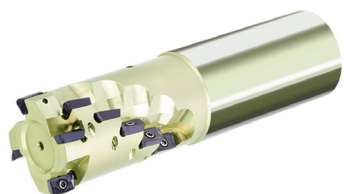
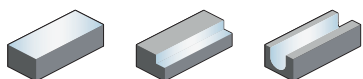



Weldon shank

Article	* Stock	Dimensions [mm]					Teeth	No. of inserts	kg	Inserts
		ØD	e	ød	L ₁	L				
EMP04-020-XP20-AP11-01	●	20	29.4	20	45	120	1	3	0.3	 APKT11T3
EMP04-025-XP25-AP11-02	●	25	38.9	25	55	130	2	8	0.4	
EMP04-032-XP32-AP11-02	●	32	48.5	32	65	140	2	10	0.7	
EMP04-040-XP40-AP11-02	●	40	58	40	75	150	2	14	1.3	

● Ex stock ○ On demand

* With internal cooling

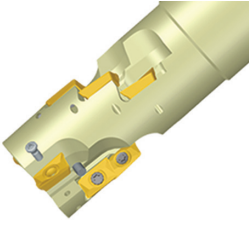
Spare parts

Insert		APKT11T3	
ØD		20-40	
	Screw (insert)	I60M2.5x6.5T (1.0Nm)	
	Wrench (insert)	WT08IS	

System code > B26

Grade selection > B24

Technical info > B527

Cutting data > B230

Indexable milling Square shoulder milling

A

Turning

B

Milling

C

Drilling

D

Technical Information

E

Index

- Ideal machining conditions
- ⊗ Normal machining conditions
- ⊗ Unfavourable machining conditions

APKT	L	S	d
11 T3	12.24	3.6	2.8

Milling inserts

AP** milling insert		HC ¹ (CVD)						HC ¹ (PVD)					HT	HC ²	HW	
	P	●	●	●	●	●	●	●	●	●	●	●	●	●		
	M	●	●	●	●	●	●	●	●	●	●	●	●	●		
	K							●								●
	N							●							●	●
	S			●	●			●	●	●	●	●				
	H															

ISO	r	I.W	Machining Conditions																					
			YBC302	YBC301	YBC401	YBM253	YBM251	YBM351	YBD152	YBD252	YBG101	YBG102	YBG202	YBG212	YBS203	YBG205	YB9320	YBG302	YBS303	YBG252	YNG151	YNG151C	YD101	YD201
	APKT11T304-ALH	0.4	6.5							●													●	●
	APKT11T308-ALH	0.8	6.5							●													●	●
	APKT11T304-APF	0.4	6.5														●							
	APKT11T308-APF	0.8	6.5										○				●	○						
	APKT11T304-APM	0.4	6.5				●		●								●							
	APKT11T308-APM	0.8	6.5				●		●				○				●	○						
	APKT11T312-APM	1.2	6.5				●		●								●							
	APKT11T316-APM	1.6	6.5				●		●								●							
	APKT11T320-APM	2	6.5				●		●								●							
	APKT11T304-LH	0.4	6.5																				○	○
	APKT11T308-LH	0.8	6.5																				○	●
	APKT11T308-NM																●							
	APKT11T312-NM																●							
	APKT11T304-PF	0.4	6.5	○		○					○	○					○							
	APKT11T308-PF	0.8	6.5									○												
	APKT11T316-PF	1.6	6.5									○												
	APKT11T304-PM	0.4	6.5	○	○	○		○	○			○	○				○							
	APKT11T308-PM	0.8	6.5	○	○		○	○	●	○	○		○	○			○	○						
	APKT11T312-PM	1.2	6.5					○				○	○				○							
	APKT11T316-PM	1.6	6.5					○				○	○				○							
	APKT11T304-PR	0.4	6.5														○							
	APKT11T316-PR	1.6	6.5														○							
	APKT11T3XR									●							●							

● Ex stock ○ On demand

HC¹ Coated carbide
 HT Uncoated cermet
 HC² Coated cermet
 HW Uncoated carbide



Square shoulder milling

EMP05 Kr: 90°

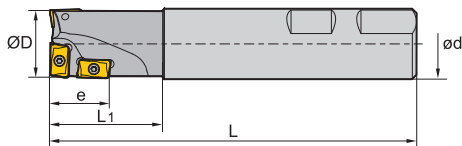
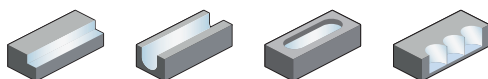

Weldon shank

Article	*	Stock	Dimensions [mm]					Teeth	kg	Inserts
			ØD	e	ød	L ₁	L			
EMP05-025-XP25-C	*	●	25	20	25	40	130	3	0.5	APMT1135

● Ex stock ○ On demand

* With internal cooling

Spare parts

Insert		APMT1135
ØD		25
	Screw (insert)	I60M2.5x6.5T (1.0Nm)
	Wrench (insert)	WT08IP

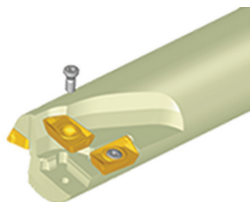

A

Turning

B

Milling

C

Drilling

D

Technical
Information

E

Index

System code > B26

Grade selection > B24

Technical info > B527

Cutting data > B230

A

Turning

- Ideal machining conditions
- Normal machining conditions
- Unfavourable machining conditions

APMT	L	S	d
11 35	11.25	3.5	2.8

Milling inserts

AN** milling insert		HC ¹ (CVD)						HC ¹ (PVD)					HT	HC ²	HW		
	P																
	M																
	K																
	N																
	S																
	H																

B

Milling

ISO		r	I.W	YBC302	YBC301	YBC401	YBM253	YBM251	YBM351	YBD152	YBD252	YBG101	YBG102	YBG202	YBG212	YBS203	YBG205	YB9320	YBG302	YBS303	YBG252	YNG151	YNG151C	YD101	YD201
	APMT1135PDR	0.8	6.2					○									●		○						

● Ex stock ○ On demand

HC¹ Coated carbide
 HT Uncoated cermet
 HC² Coated cermet
 HW Uncoated carbide

C

Drilling

D

Technical Information

E

Index

System code > B26

Grade selection > B24

Technical info > B527

Cutting data > B230

Square shoulder milling

EMP09 Kr: 90°

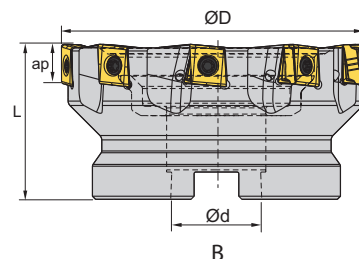
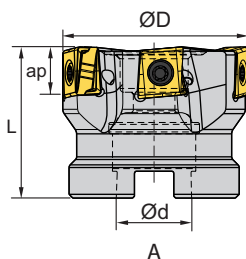
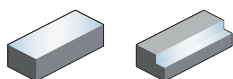

Article	*	Stock	Dimensions [mm]				Teeth	Coupling	kg	Inserts
			ØD	ød	L	a _p max				
EMP09-040-A16-LN08-05C	*	●	40	16	40	8	5	A		
EMP09-050-A22-LN08-06C	*	●	50	22	40	8	6	A		
EMP09-063-A22-LN08-08C	*	●	63	22	40	8	8	A		
EMP09-080-A27-LN08-10C	*	○	80	27	50	8	10	A		
EMP09-040-A16-LN12-04C	*	●	40	16	40	11.5	4	A	0.19	
EMP09-050-A22-LN12-05C	*	●	50	22	40	11.5	5	A	0.33	
EMP09-063-A22-LN12-06C	*	●	63	22	40	11.5	6	A	0.53	
EMP09-080-A27-LN12-07C	*	●	80	27	50	11.5	7	A	1.18	
EMP09-100-B32-LN12-09C	*	●	100	32	50	11.5	9	B	1.62	
EMP09-125-B40-LN12-11C	*	●	125	40	63	11.5	11	B	3.25	
EMP09-080-A27-LN16-06C	*	●	80	27	50	15	6	A		
EMP09-100-B32-LN16-08C	*	●	100	32	50	15	8	B		
EMP09-125-B40-LN16-10C	*	●	125	40	63	15	10	B		
EMP09-160-B40-LN16-12C	*	●	160	40	63	15	12	B		
EMP09-200-C60-LN16-16		○	200	60	70	15	16	C		
EMP09-250-C60-LN16-12		○	250	60	70	15	12	C		
EMP09-315-D60-LN16-16		○	315	60	80	15	16	D		

● Ex stock ○ On demand

* With internal cooling

Spare parts				
	Insert	LNKT0804PNR	LNKT1206PNR	LNKT1607PNR
	ØD	40-80	40-125	80-360
	Screw (clamp)	I60M3×7 (1.8 Nm)	I60M4×12 (3.4 Nm)	
	Screw (insert)			I60M5×17 (6.7 Nm)
	Wrench	WT10IS	WT15IS	
	Wrench (insert)			WT20IS

System code > B26

Grade selection > B24

Technical info > B527

Cutting data > B230



A

Turning

B

Milling

C

Drilling

D

Technical Information

E

Index

- Ideal machining conditions
- ⊗ Normal machining conditions
- ⊗ Unfavourable machining conditions

LNKT	L	S
08 04	8.75	4.45
12 06	12.7	6.75
16 07	16.05	7.35

Milling inserts

LN** milling insert			HC ¹ (CVD)						HC ¹ (PVD)						HT	HC ²	HW								
	P		●	●	●	●	●	●	●	●	●	●	●	●	●	●									
	M		●	●	●	●	●	●	●	●	●	●	●	●	●	●									
	K									●							●								
	N									●							●								
	S				●	●				●	●	●	●	●	●										
	H																								
	ISO	W	r	YBC302	YBC301	YBC401	YBM253	YBM251	YBM351	YBD152	YBD252	YBG101	YBG102	YBG202	YBG212	YBS203	YBG205	YB9320	YBG302	YBS303	YBG252	YNG151	YNG151C	YD101	YD201
	LNKT080404PNR-GL	8.5	0.4								●							●	●						
	LNKT120608PNR-GL	13	0.8								●							●	●						
	LNKT160708PNR-GL	15	0.8								●							●	●						
	LNKT080404PNR-GM	8.5	0.4				●											●		●					
	LNKT120608PNR-GM	13	0.8				●				●							●		●					
	LNKT160708PNR-GM	15	0.8				●		○									●		●					

● Ex stock ○ On demand

HC¹ Coated carbide
 HT Uncoated cermet
 HC² Coated cermet
 HW Uncoated carbide

System code > B26

Grade selection > B24

Technical info > B527

Cutting data > B230

Square shoulder milling

EMP09 Kr: 90°

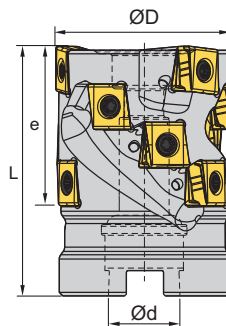
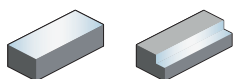



Article	*	Stock	Dimensions [mm]				Teeth row	Teeth	Coupling	kg	Inserts
			ØD	e	ød	L					
EMP09-040x43-A16-LN12-02C	*	○	40	43	16	70	2	8	A	0.4	LNKT1206PNR
EMP09-050x43-A22-LN12-03C	*	●	50	43	22	70	3	12	A	0.64	
EMP09-063x53-A27-LN12-04C	*	●	63	53	27	80	4	20	A	1.31	
EMP09-080x53-A27-LN12-05C	*	○	80	53	27	80	5	25	A	2.33	
EMP09-080x53-A32-LN12-05C	*	○	80	54.6	32	80	5	25	A	2.33	
EMP09-080x74-A32-LN12-05C	*	○	80	74	32	100	5	35	A		

● Ex stock ○ On demand

* With internal cooling

Spare parts

	Insert	LNKT1206PNR
	ØD	40-80
	Screw (clamp)	I60M4x12 (3.4Nm)
	Wrench	WT15IS

System code > B26

Grade selection > B24

Technical info > B527

Cutting data > B230

A

Turning

- Ideal machining conditions
- ⊗ Normal machining conditions
- ⊗ Unfavourable machining conditions

LNKT	L	S
12 06	12.7	6.75

Milling inserts

LN** milling insert		HC ¹ (CVD)						HC ¹ (PVD)						HT	HC ²	HW	
	P	⊗	⊗	⊗	⊗	⊗	⊗	⊗	⊗	⊗	⊗	⊗	⊗	⊗	⊗	⊗	⊗
	M	⊗	⊗	⊗	⊗	⊗	⊗	⊗	⊗	⊗	⊗	⊗	⊗	⊗	⊗	⊗	⊗
	K								⊗								⊗
	N								⊗								⊗
	S			⊗	⊗				⊗	⊗	⊗	⊗	⊗	⊗			
	H																

B

Milling

ISO		W	r	YBC302	YBC301	YBC401	YBM253	YBM251	YBM351	YBD152	YBD252	YBG101	YBG102	YBG202	YBG212	YBS203	YBG205	YB9320	YBG302	YBS303	YBG252	YNG151	YNG151C	YD101	YD201
	LNKT120608PNR-GL	13	0.8								●							●		●					
	LNKT120608PNR-GM	13	0.8				●			●								●							

● Ex stock ○ On demand

HC¹ Coated carbide
 HT Uncoated cermet
 HC² Coated cermet
 HW Uncoated carbide

C

Drilling

D

Technical Information

E

Index

System code > B26

Grade selection > B24

Technical info > B527

Cutting data > B230

Square shoulder milling

EMP13 Kr: 90°

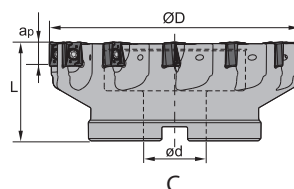
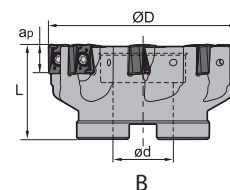
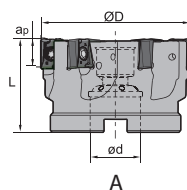
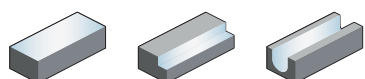

Article	*	Stock	Dimensions [mm]				Teeth	Coupling	kg	Inserts	
			ØD	ød	L	ap max					
EMP13-040-A16-AN11-04C	*	○	40	16	40	11.2	4	A	0.45	ANGX1105	
EMP13-050-A22-AN11-06C	*	●	50	22	40	11.2	6	A	0.3		
EMP13-063-A22-AN11-06	*	○	63	22	40	11.2	6	A	0.49		
EMP13-063-A22-AN11-07C	*	●	63	22	40	11.2	7	A	0.49		
EMP13-080-A27-AN11-07	*	○	80	27	50	11.2	7	A	1.18		
EMP13-080-A27-AN11-09C	*	●	80	27	50	11.2	9	A	1.18		
EMP13-100-B32-AN11-12		●	100	32	50	11.2	12	B	1.46		
EMP13-100-B32-AN11-12C	*	○	100	32	50	11.2	12	B	1.46		
EMP13-125-B40-AN11-14		●	125	40	63	11.2	14	B	2.92		
EMP13-125-B40-AN11-14C	*	○	125	40	63	11.2	14	B	2.92		
EMP13-160-C40-AN11-16		●	160	40	63	11.2	16	C	4.3		
EMP13-050-A22-AN15-04C	*	●	50	22	40	14.5	4	A	0.26		ANGX1506
EMP13-060-A22-AN15-05C	*	○	60	22	40	14.5	5	A	0.53		
EMP13-063-A22-AN15-05C	*	●	63	22	40	14.5	5	A	0.53		
EMP13-080-A27-AN15-06C	*	●	80	27	50	14.5	6	A	1.23		
EMP13-100-B32-AN15-08		●	100	32	50	14.5	8	B	1.52		
EMP13-100-B32-AN15-08C	*	○	100	32	50	14.5	8	B	1.52		
EMP13-125-B40-AN15-10		●	125	40	63	14.5	10	B	3.05		
EMP13-125-B40-AN15-10C	*	○	125	40	63	14.5	10	B	3.05		
EMP13-160-C40-AN15-12		●	160	40	63	14.5	12	C	4.46		
EMP13-200-C60-AN15-16		○	200	60	63	14.5	16	C	6.26		

● Ex stock ○ On demand

* With internal cooling

System code > B26

Grade selection > B24

Technical info > B527

Cutting data > B230



A

Turning

Spare parts		ANGX1105	ANGX1506
Insert		40-160	50-200
ØD			
	Screw (clamp)		I60M4×12 (3.4Nm)
	Screw (insert)	I60M3×9 (1.8 Nm)	I60M4×12 (3.4 Nm)
	Wrench		WT15IS
	Wrench (insert)	WT09IS	WT15IS



B

Milling

Milling inserts

- Ideal machining conditions
- Normal machining conditions
- Unfavourable machining conditions

ANGX	L	S	d
11 05	11.85	5.7	3.5
15 06	15.43	7.3	4.4

C

Drilling

AN** milling insert		HC ¹ (CVD)						HC ¹ (PVD)						HT	HC ²	HW									
ISO		W	r	YBC302	YBC301	YBC401	YBM253	YBM251	YBM351	YBD152	YBD252	YBG101	YBG102	YBG202	YBG212	YBS203	YBG205	YB9320	YBG302	YBS303	YBG252	YNG151	YNG151C	YD101	YD201
	ANGX110504PNR-GM	8.4	0.4				●																		
	ANGX110508PNR-GM	8.4	0.8	●			●		●	●							●	●							
	ANGX110520PNR-GM	8.4	2				●				●						●								
	ANGX150608PNR-GM	11	0.8	○			●		●	●							●	●							
	ANGX150616PNR-GM	11	1.6				●		●								●								
	ANGX150620PNR-GM	11	2							●	●						●								
	ANGX110504PNR-LH	8.4	0.4																						●
	ANGX150608PNR-LH	11	0.8																						●

● Ex stock ○ On demand

HC¹ Coated carbide
 HT Uncoated cermet
 HC² Coated cermet
 HW Uncoated carbide

D

Technical Information

E

Index

System code > B26

Grade selection > B24

Technical info > B527

Cutting data > B230

Square shoulder milling

EMP13 Kr: 90°

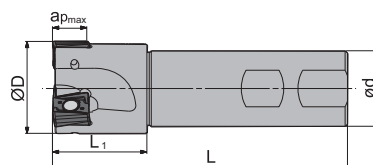
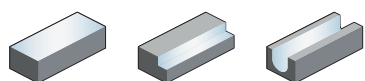

Weldon shank

Article	*	Stock	Dimensions [mm]					Teeth	kg	Inserts
			ØD	ød	L ₁	L	a _{p max}			
EMP13-025-XP25-AN11-02C	*	●	25	25	32	100	11.2	2	0.31	ANGX1105
EMP13-032-XP32-AN11-03C	*	●	32	32	40	115	11.2	3	0.61	
EMP13-040-XP32-AN11-04C	*	●	40	32	40	125	11.2	4	0.75	
EMP13-032-XP32-AN15-02C	*	●	32	32	40	125	11.2	2	0.66	ANGX1506
EMP13-040-XP32-AN15-03C	*	●	40	32	40	125	11.2	3	0.76	

● Ex stock ○ On demand

* With internal cooling

Spare parts

	Insert ØD	ANGX1105	ANGX1506	
		25-40	25-40	
Screw (insert)		I60M3×9 (1.8 Nm)	I60M4×12 (3.4 Nm)	
Wrench (insert)		WT09IS	WT15IS	

System code > B26

Grade selection > B24

Technical info > B527

Cutting data > B230

Indexable milling Square shoulder milling

A

Turning

B

Milling

C

Drilling

D

Technical Information

E

Index

- Ideal machining conditions
- ⊗ Normal machining conditions
- ⊗ Unfavourable machining conditions

ANGX	L	S	d
11 05	11.85	5.7	3.5
15 06	15.43	7.3	4.4

Milling inserts

AN** milling insert		HC ¹ (CVD)						HC ¹ (PVD)						HT	HC ²	HW								
		P	⊗	⊗	⊗	⊗	⊗	⊗	⊗	⊗	⊗	⊗	⊗	⊗	●	●	●							
		M	⊗	⊗	⊗	⊗	⊗	⊗	⊗	⊗	⊗	⊗	⊗	⊗	●	●	●							
		K							⊗						●		⊗							
		N							⊗								⊗	⊗						
		S		⊗	⊗				⊗	⊗	⊗	⊗	⊗	⊗										
		H																						
ISO	W	r	YBC302	YBC301	YBC401	YBM253	YBM251	YBM351	YBD152	YBD252	YBG101	YBG102	YBG202	YBG212	YBS203	YBG205	YB9320	YBG302	YBS303	YBG252	YNG151	YNG151C	YD101	YD201
	ANGX110504PNR-GM	8.4	0.4			●			●							●	●							
	ANGX110508PNR-GM	8.4	0.8	●		●			●	●						●	●							
	ANGX110520PNR-GM	8.4	2			●			●							●								
	ANGX150608PNR-GM	11	0.8	○		●			●	●						●	●							
	ANGX150616PNR-GM	11	1.6			●			●							●								
	ANGX150620PNR-GM	11	2						●	●						●								
	ANGX110504PNR-LH	8.4	0.4																					●
	ANGX150608PNR-LH	11	0.8																					●

● Ex stock ○ On demand

HC¹ Coated carbide
 HT Uncoated cermet
 HC² Coated cermet
 HW Uncoated carbide



Square shoulder milling

EMP13 Kr: 90°

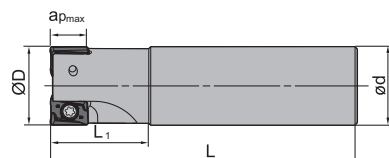
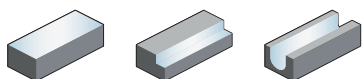

Straight shank

Article	*	Stock	Dimensions [mm]						Teeth	kg	Inserts
			ØD	e	ød	L ₁	L	a _{p max}			
EMP13-025-G25-AN11-02C	*	●	25	11.2	25	32	100	11.2	2	0.31	ANGX1105
EMP13-032-G32-AN11-03C	*	●	32	11.2	32	40	115	11.2	3	0.61	
EMP13-040-G32-AN11-04C	*	●	40	11.2	32	40	125	11.2	4	0.75	
EMP13-032-G32-AN15-02C	*	●	32	14.5	32	40	125	14.5	2	0.66	ANGX1506
EMP13-040-G32-AN15-03C	*	●	40	14.5	32	40	125	14.5	3	0.76	

● Ex stock ○ On demand

* With internal cooling

Spare parts

	Insert ØD	ANGX1105	ANGX1506	
		25-40	25-40	
Screw (insert)		I60M3×9 (1.8 Nm)	I60M4×12 (3.4 Nm)	
Wrench (insert)		WT09IS	WT15IS	

System code > B26

Grade selection > B24

Technical info > B527

Cutting data > B230

Indexable milling Square shoulder milling

A

Turning

B

Milling

C

Drilling

D

Technical Information

E

Index

- Ideal machining conditions
- ⊗ Normal machining conditions
- ⊗ Unfavourable machining conditions

ANGX	L	S	d
11 05	11.85	5.7	3.5
15 06	15.43	7.3	4.4

Milling inserts

AN** milling insert		HC ¹ (CVD)						HC ¹ (PVD)						HT	HC ²	HW								
		P	⊗	⊗	⊗	⊗	⊗	⊗	⊗	⊗	⊗	⊗	⊗	⊗	●	●	●							
		M	⊗	⊗	⊗	⊗	⊗	⊗	⊗	⊗	⊗	⊗	⊗	⊗	●	●	●							
		K	⊗	⊗	⊗	⊗	⊗	⊗	⊗	⊗	⊗	⊗	⊗	⊗	●	●	●							
		N	⊗	⊗	⊗	⊗	⊗	⊗	⊗	⊗	⊗	⊗	⊗	⊗	●	●	●							
		S	⊗	⊗	⊗	⊗	⊗	⊗	⊗	⊗	⊗	⊗	⊗	⊗	●	●	●							
		H	⊗	⊗	⊗	⊗	⊗	⊗	⊗	⊗	⊗	⊗	⊗	⊗	●	●	●							
ISO	W	r	YBC302	YBC301	YBC401	YBM253	YBM251	YBM351	YBD152	YBD252	YBG101	YBG102	YBG202	YBG212	YBS203	YBG205	YB9320	YBG302	YBS303	YBG252	YNG151	YNG151C	YD101	YD201
	ANGX110504PNR-GM	8.4	0.4			●			●							●	●							
	ANGX110508PNR-GM	8.4	0.8	●		●			●	●						●	●							
	ANGX110520PNR-GM	8.4	2			●			●							●								
	ANGX150608PNR-GM	11	0.8	○		●			●	●						●	●							
	ANGX150616PNR-GM	11	1.6			●			●							●								
	ANGX150620PNR-GM	11	2						●	●						●								
	ANGX110504PNR-LH	8.4	0.4																				●	
	ANGX150608PNR-LH	11	0.8																				●	

● Ex stock ○ On demand

HC¹ Coated carbide
 HT Uncoated cermet
 HC² Coated cermet
 HW Uncoated carbide



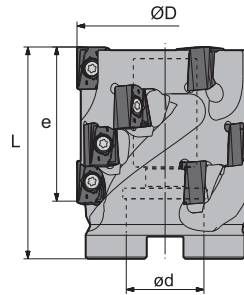
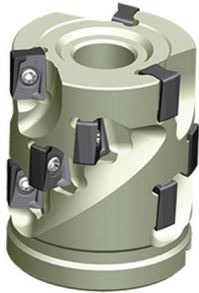
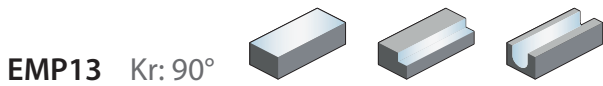

Square shoulder milling



Article	*	Stock	Dimensions [mm]				Teeth	No. of inserts	kg	Inserts 
			ØD	e	ød	L				
EMP13-050x43-A22-AN11-03		●	50	43	22	60	3	12	0.52	ANGX1105
EMP13-063x64-A27-AN11-04		○	63	64	27	80	4	24	1.15	
EMP13-063x53-A27-AN15-03		○	63	53	27	75	3	12	1.14	ANGX1506
EMP13-080x53-A32-AN15-04		●	80	53	32	75	4	16	1.82	

● Ex stock ○ On demand

*With internal cooling

Spare parts			
	Insert ØD	ANGX1105 50-63	ANGX1506 63-80
	Screw (insert)	I60M3x9 (1.8 Nm)	I60M4x12 (3.4 Nm)
	Wrench (insert)	WT09IS	WT15IS



A

Turning

B

Milling

C



Drilling

D

Technical Information











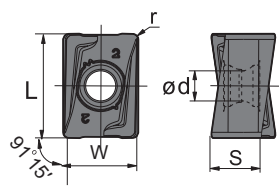































E

Index

-  Ideal machining conditions
-  Normal machining conditions
-  Unfavourable machining conditions

ANGX	L	S	d
11 05	11.85	5.7	3.5
15 06	15.43	7.3	4.4

Milling inserts

AN** milling insert		HC ¹ (CVD)						HC ¹ (PVD)						HT	HC ²	HW									
	P																								
	M																								
	K																								
	N																								
	S																								
	H																								
ISO	W	r	YBC302	YBC301	YBC401	YBM253	YBM251	YBM351	YBD152	YBD252	YBG101	YBG102	YBG202	YBG212	YBS203	YBG205	YB9320	YBG302	YBS303	YBG252	YNG151	YNG151C	YD101	YD201	
	ANGX110504PNR-GM	8.4	0.4				●		●							●	●								
	ANGX110508PNR-GM	8.4	0.8	●			●		●	●						●	●								
	ANGX110520PNR-GM	8.4	2				●			●						●									
	ANGX150608PNR-GM	11	0.8	○			●		●	●						●	●								
	ANGX150616PNR-GM	11	1.6				●		●							●									
	ANGX150620PNR-GM	11	2						●	●						●									
	ANGX110504PNR-LH	8.4	0.4																					●	
	ANGX150608PNR-LH	11	0.8																					●	

● Ex stock ○ On demand

- HC¹ Coated carbide
- HT Uncoated cermet
- HC² Coated cermet
- HW Uncoated carbide



Square shoulder milling

EMP13 Kr: 90°

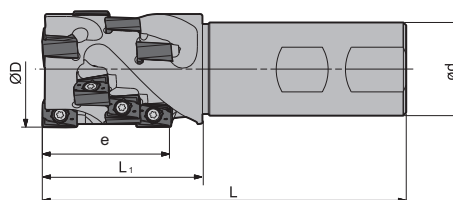
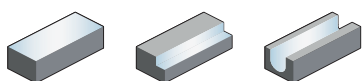



Weldon shank

Article	* Stock	Dimensions [mm]					Teeth	No. of inserts	kg	Inserts
		ØD	e	ød	L ₁	L				
EMP13-032x43-XP32-AN11-02	○	32	43	32	48	115	2	8	0.61	ANGX1105
EMP13-040x43-XP32-AN11-03	○	40	43	32	55	125	3	12	0.79	
EMP13-040x40-XP32-AN15-02	○	40	40	32	55	115	2	6	0.79	ANGX1506
EMP13-050x53-XP40-AN15-02	○	50	53	40	70	145	2	8	1.53	

● Ex stock ○ On demand

* With internal cooling

Spare parts			
	Insert ØD	ANGX1105 32-40	ANGX1506 40-50
	Screw (insert)	I60M3×9 (1.8 Nm)	I60M4×12 (3.4 Nm)
	Wrench (insert)	WT09IS	WT15IS

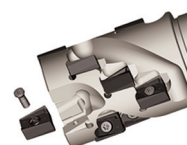

A

Turning

B

Milling

C

Drilling

D

Technical
Information

E

Index

Indexable milling Square shoulder milling

A

Turning

- Ideal machining conditions
- ⊗ Normal machining conditions
- ⊗ Unfavourable machining conditions

ANGX	L	S	d
11 05	11.85	5.7	3.5
15 06	15.43	7.3	4.4

Milling inserts

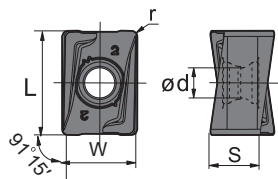

AN** milling insert		HC ¹ (CVD)						HC ¹ (PVD)						HT	HC ²	HW
	P	⊗	⊗	⊗	⊗	⊗	⊗	⊗	⊗	⊗	⊗	⊗	⊗	⊗	⊗	
	M	⊗	⊗	⊗	⊗	⊗		⊗	⊗	⊗	⊗	⊗	⊗	⊗	⊗	
	K					⊗	⊗	⊗								⊗
	N							⊗								⊗
	S		⊗	⊗				⊗	⊗	⊗	⊗	⊗				
	H															

B

Milling

ISO	W	r	Grade selection																					
			YBC302	YBC301	YBC401	YBM253	YBM251	YBM351	YBD152	YBD252	YBG101	YBG102	YBG202	YBG212	YBS203	YBG205	YB9320	YBG302	YBS303	YBG252	YNG151	YNG151C	YD101	YD201
ANGX110504PNR-GM	8.4	0.4				●		●							●	●								
ANGX110508PNR-GM	8.4	0.8	●			●		●	●						●	●								
ANGX110520PNR-GM	8.4	2				●			●						●									
ANGX150608PNR-GM	11	0.8	○			●		●	●						●	●								
ANGX150616PNR-GM	11	1.6				●		●							●									
ANGX150620PNR-GM	11	2							●	●					●									
ANGX110504PNR-LH	8.4	0.4																					●	
ANGX150608PNR-LH	11	0.8																					●	

● Ex stock ○ On demand

HC¹ Coated carbide
 HT Uncoated cermet
 HC² Coated cermet
 HW Uncoated carbide

C

Drilling

D

Technical Information

E

Index



Profile milling

BMR01

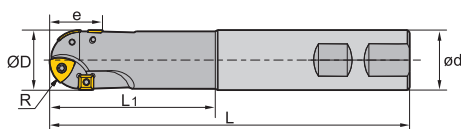
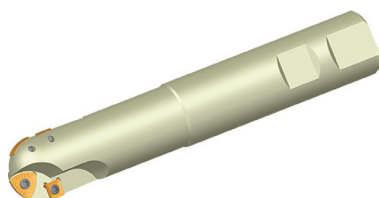
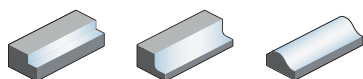

Weldon shank

Article	* Stock	Dimensions [mm]							Teeth		kg	Inserts
		R	ØD	e	ød	L ₁	L	ZDET	SPMT			
BMR01-020-XP20-S	○	10	20	20	20	50	125	2	2	0.3	ZDET08T2 & SPMT0603	
BMR01-020-XP20-M	○	10	20	20	20	75	150	2	2	0.3		
BMR01-020-XP20-L	○	10	20	20	20	100	200	2	2	0.4		
BMR01-025-XP25-S	○	12.5	25	23	25	70	150	2	2	0.5	ZDET1103 & SPMT0603	
BMR01-025-XP25-M	○	12.5	25	23	25	95	175	2	2	0.6		
BMR01-025-XP25-L	○	12.5	25	23	25	100	200	2	2	0.7		
BMR01-032-XP32-S	○	16	32	31	32	85	175	2	2	0.9	ZDET13T2 & SDMT0903	
BMR01-032-XP32-M	○	16	32	31	32	100	200	2	2	1.1		
BMR01-032-XP32-L	○	16	32	31	32	150	250	2	2	1.4		
BMR01-040-XP40-S	○	20	40	41	40	85	175	3	2	1.4	ZPNT2204 & SPMT1204	
BMR01-040-XP40-M	○	20	40	41	40	100	200	3	2	1.7		
BMR01-040-XP40-L	○	20	40	41	40	150	250	3	2	2.1		
BMR01-050-XP40-S	○	25	50	45	40	100	200	3	2	1.8		
BMR01-050-XP40-M	○	25	50	45	40	100	300	3	2	2.8		
BMR01-063-XP40-S	○	31.5	63	52	40	100	200	4	2	3		

● Ex stock ○ On demand

* With internal cooling

Spare parts

	Insert ØD	ZDET08T2 & SPMT0603 20	ZDET1103 & SPMT0603 25	ZDET13T2 & SDMT0903 32	ZPNT2204 & SPMT1204 40-63	
	Screw (insert)	I43M2.5x5.7 (1.0 Nm)	I43M2.5x5.7 (1.0 Nm)	I43M4x8 (3.4 Nm)	I43M5x11 (6.7 Nm)	
	Wrench (insert)	WT07IP	WT07IP			
	Wrench (insert)			WT15IS	WT20IS	

System code > B26

Grade selection > B24

Technical info > B527

Cutting data > B230

A

Turning

B

Milling

C

Drilling

D

Technical Information

E

Index

ZDET	L	I.C	S	d
08 T2	8.4	6,75	2.78	2.8
11 03	10.6	8.5	3.18	2.8
13 T3	13.2	10.5	3.97	4.4
22 04	16.1	12.7	4.76	5.56

- Ideal machining conditions
- ⊗ Normal machining conditions
- ⊗ Unfavourable machining conditions

Milling inserts

ZD** milling insert			HC ¹ (CVD)						HC ¹ (PVD)						HT	HC ²	HW								
	P		⊗	⊗	⊗	⊗	⊗	⊗	⊗	⊗	⊗	⊗	⊗	⊗	⊗	⊗	⊗	⊗							
	M		⊗	⊗	⊗	⊗	⊗	⊗	⊗	⊗	⊗	⊗	⊗	⊗	⊗	⊗	⊗	⊗							
	K																								
	N								⊗																
	S			⊗	⊗				⊗	⊗	⊗	⊗	⊗	⊗											
	H																								
	ISO	R	YBC302	YBC301	YBC401	YBM253	YBM251	YBM351	YBD152	YBD252	YBG101	YBG102	YBG202	YBG212	YBS203	YBG205	YB9320	YBG302	YBS303	YBG252	YNG151		YNG151C	YD101	YD201
	ZDET13T3Cyr16-PM	16				○							○												
	ZDET08T2Cyr10	10				○																			
	ZDET1103Cyr12.5	12.5				○																			
	ZPNT2204CY(R20)	20				○																			
	ZPNT2204CY(R25)	25				●																			
	ZPNT2204CY(R31)	31.5				○																			

● Ex stock ○ On demand

HC¹ Coated carbide
 HT Uncoated cermet
 HC² Coated cermet
 HW Uncoated carbide



Milling inserts

- Ideal machining conditions
- Normal machining conditions
- Unfavourable machining conditions

SPMT	L	I.C	S	d
06 03	6.35	6.35	3.18	2.8
12 04	12.7	12.7	4.76	5.5

SP** milling insert		HC ¹ (CVD)						HC ¹ (PVD)					HT	HC ²	HW									
	P	●	●	●	●	●	●	●	●	●	●	●	●	●										
	M	●	●	●	●	●	●	●	●	●	●	●	●	●										
	K							●								●								
	N							●							●	●								
	S		●		●			●	●	●	●	●	●											
	H																							
ISO		r	YBC302	YBC301	YBC401	YBM253	YBM251	YBM351	YBD152	YBD252	YBG101	YBG102	YBG202	YBG212	YBS203	YBG205	YB9320	YBG302	YBS303	YBG252	YNG151	YNG151C	YD101	YD201
	SPMT060304-KT		○																					
	SPMT060304	0.4				●												○						
	SPMT120408	0.8	○	○	○	●	○											○						

● Ex stock ○ On demand

HC¹ Coated carbide
 HT Uncoated cermet
 HC² Coated cermet
 HW Uncoated carbide

Milling inserts

- Ideal machining conditions
- Normal machining conditions
- Unfavourable machining conditions

SDMT	L	I.C	S	d
09 03	9.525	9.525	3.18	4.4

SD** milling insert		HC ¹ (CVD)						HC ¹ (PVD)					HT	HC ²	HW									
	P	●	●	●	●	●	●	●	●	●	●	●	●	●										
	M	●	●	●	●	●	●	●	●	●	●	●	●	●										
	K							●								●								
	N							●							●	●								
	S		●		●			●	●	●	●	●	●											
	H																							
ISO		r	YBC302	YBC301	YBC401	YBM253	YBM251	YBM351	YBD152	YBD252	YBG101	YBG102	YBG202	YBG212	YBS203	YBG205	YB9320	YBG302	YBS303	YBG252	YNG151	YNG151C	YD101	YD201
	SDMT090308	0.8				●																		

● Ex stock ○ On demand

HC¹ Coated carbide
 HT Uncoated cermet
 HC² Coated cermet
 HW Uncoated carbide

Profile milling

BMR02

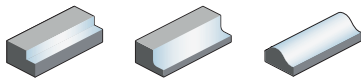

Article	*	Stock	Dimensions [mm]					kg	Inserts
			R	ØD	ød	L ₁	L		
BMR02-012-G16-S	●		6	12	16	40	110	0.1	ROHX1203
BMR02-012-G16-M	●		6	12	16	50	130	0.2	
BMR02-012-G16-L	●		6	12	16	50	160	0.2	
BMR02-016-G20-S	●		8	16	20	45	140	0.3	ROHX1604
BMR02-016-G20-M	●		8	16	20	65	170	0.3	
BMR02-016-G20-L	●		8	16	20	65	200	0.4	
BMR02-020-G25-S	●		10	20	25	60	160	0.5	ROHX2005
BMR02-020-G25-M	●		10	20	25	80	200	0.6	
BMR02-020-G25-L	●		10	20	25	80	240	0.8	

● Ex stock ○ On demand

* With internal cooling

Spare parts		ROHX1203	ROHX1604	ROHX2005	
Insert	ØD	12	16	20	
Screw (insert)		I70M4×10TT (3.4 Nm)	I70M5×12TT (6.7 Nm)	I70M5×16TT (6.7 Nm)	
Wrench (insert)		WT15IS	WT20IS	WT20IS	



System code > B26

Grade selection > B24



Technical info > B527

Cutting data > B230

ROHX	L	I.C	S	d
12 03	8.5	12	3	4
16 04	11.3	16	4	5
20 05	14.1	20	5	5

-  Ideal machining conditions
-  Normal machining conditions
-  Unfavourable machining conditions

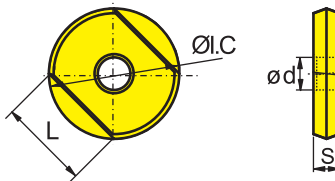
Milling inserts

RO** positive insert		HC ¹ (CVD)						HC ¹ (PVD)					HT	HC ²	HW									
	P																							
	M																							
	K																							
	N																							
	S																							
	H																							
ISO		YBC302	YBC301	YBC401	YBM253	YBM251	YBM351	YBD152	YBD252	YBG101	YBG102	YBG202	YBG212	YBS203	YBG205	YB9320	YBG302	YBS303	YBG252	YNG151	YNG151C	YD101	YD201	
	ROHX1604																							
	ROHX1203										○	○												
	ROHX2005										○													

● Ex stock ○ On demand

HC¹ Coated carbide
 HT Uncoated cermet
 HC² Coated cermet
 HW Uncoated carbide

A

Turning

B

Milling

C

Drilling

D

Technical Information

E

Index



Profile milling

BMR03

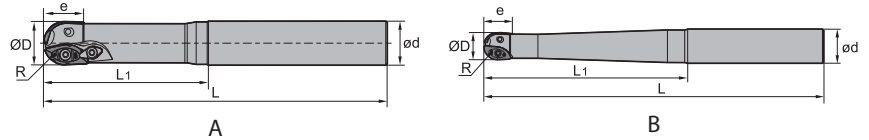
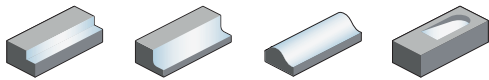

Straight shank

Article	* Stock	Dimensions [mm]							Teeth	Coupling	kg	Inserts
		R	ØD	e	ød	L ₁	L					
BMR03-016-G20-S	●	8	16	16	20	70	150	2	B	0.3	XPHT16	
BMR03-016-G20-M	●	8	16	16	20	80	180	2	B	0.4		
BMR03-020-G25-S	●	10	20	20	25	80	180	2	B	0.5	XPHT20	
BMR03-020-G25-M	●	10	20	20	25	100	200	2	B	0.6		
BMR03-020-G25-L	●	10	20	20	25	150	250	2	B	0.7		
BMR03-020-G25-XL	○	10	20	20	25	110	300	2	B	1	XPHT25	
BMR03-025-G25-S	●	12.5	25	25	25	80	180	2	B	0.6		
BMR03-025-G25-M	●	12.5	25	25	25	100	200	2	B	0.7		
BMR03-025-G25-L	○	12.5	25	25	25	110	250	2	B	0.8		
BMR03-025-G25-XL	○	12.5	25	25	25	120	300	2	B	1	XPHT30	
BMR03-030-G32-S	○	15	30	30	32	120	200	2	A	1		
BMR03-030-G32-M	●	15	30	30	32	150	250	2	A	1.3		
BMR03-030-G32-L	○	15	30	30	32	200	300	2	A	1.6	XPHT32	
BMR03-032-G32-S	●	16	32	32	32	120	200	2	A	1.1		
BMR03-032-G32-M	●	16	32	32	32	150	250	2	A	1.4		
BMR03-032-G32-L	●	16	32	32	32	200	300	2	A	1.6		
BMR03-032-G32-XL	○	16	32	32	32	200	350	2	A	2	XPHT40	
BMR03-040-G40-S	○	20	40	40	40	120	200	2	A	1.6		
BMR03-040-G40-M	○	20	40	40	40	150	250	2	A	2		
BMR03-040-G40-L	●	20	40	40	40	200	300	2	A	2.5		

● Ex stock ○ On demand

* With internal cooling

System code > B26

Grade selection > B24

Technical info > B527

Cutting data > B230

Spare parts							
Insert	XPHT16	XPHT20	XPHT25	XPHT30	XPHT32	XPHT40	
ØD	16	20	25	30	32	40	
	Clamp						CBH5R1
	Clamp				WD-208	WD-208	
	Screw (clamp)				I60M5×13 (6.7 Nm)	I60M5×13 (6.7 Nm)	I43M6×16 (9.1 Nm)
	Screw (insert)	I60M2.5×6.5 (1.0 Nm)		I60M4×10 (3.4 Nm)	I60M5×13 (6.7 Nm)	I60M5×13 (6.7 Nm)	I43M6×16 (9.1 Nm)
	Screw (insert)		I60M3.5×08TT (2.7 Nm)				
	Wrench (clamp)				WT20IT	WT20IT	WT25IT
	Wrench (insert)		WT10IP				
	Wrench (insert)				WT20IT	WT20IT	WT25IT
	Wrench (insert)	WT07P					
	Wrench (insert)			WT15S			



XPHT	L	S	d
16	16	3.18	3.1
20	20	3.97	4
25	25	4.76	4.7
30	30	6.35	5.8
32	32	6.35	5.8
40	40	7.94	6.8

- Ideal machining conditions
- Normal machining conditions
- Unfavourable machining conditions

Milling inserts

XP** milling insert		HC ¹ (CVD)						HC ¹ (PVD)						HT	HC ²	HW										
ISO		R	α	YBC302	YBC301	YBC401	YBM253	YBM251	YBM351	YBD152	YBD252	YBG101	YBG102	YBG202	YBG212	YBS203	YBG205	YB9320	YBG302	YBS303	YBG252	YNG151	YNG151C	YD101	YD201	
	P			●	●	●	●	●	●	●	●	●	●	●	●	●	●	●	●	●	●	●	●			
	M			●	●	●	●	●	●	●	●	●	●	●	●	●	●	●	●	●	●	●	●			
	K								●	●															●	
	N											●													●	●
	S														●	●	●	●	●	●	●	●				
	H																									
	XPHT16R0803-GM	8	9																●							
	XPHT20R10T3-GM	10	9																●							
	XPHT25R1204-GM	12.5	9																●							
	XPHT30R1506-GM	15	11																●							
	XPHT32R1606-GM	16	9																●							
	XPHT40R2007-GM	20	9																●							

● Ex stock ○ On demand

HC¹ Coated carbide
 HT Uncoated cermet
 HC² Coated cermet
 HW Uncoated carbide

Profile milling

BMR03

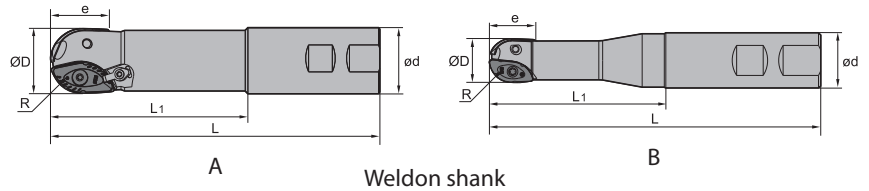
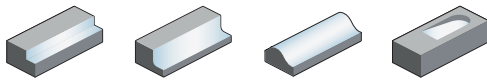

Article	* Stock	Dimensions [mm]							Teeth	Coupling	kg	Inserts
		R	$\varnothing D$	e	$\varnothing d$	L_1	L					
BMR03-016-XP20-M	●	8	16	16	20	60	111	2	B	0.2	XPHT16	
BMR03-020-XP25-M	●	10	20	20	25	70	127	2	B	0.3	XPHT20	
BMR03-020-XP25-L	●	10	20	20	25	80	150	2	B	0.4	XPHT25	
BMR03-025-XP25-M	●	12.5	25	25	25	80	137	2	B	0.4	XPHT25	
BMR03-025-XP25-L	●	12.5	25	25	25	100	200	2	B	0.6	XPHT30	
BMR03-030-XP32-M	●	15	30	30	32	100	161	2	A	0.8	XPHT30	
BMR03-030-XP32-L	●	15	30	30	32	150	250	2	A	1.3	XPHT32	
BMR03-032-XP32-M	●	16	32	32	32	100	161	2	A	0.8	XPHT32	
BMR03-032-XP32-L	○	16	32	32	32	120	250	2	A	1.3	XPHT40	
BMR03-040-XP40-M	○	20	40	40	40	100	175	2	A	1.3	XPHT40	
BMR03-040-XP40-L	●	20	40	40	40	120	250	2	A	2	XPHT50	
BMR03-050-XP50-M	○	25	50	50	50	100	200	2	A	2.5	XPHT50	
BMR03-050-XP50-L	○	25	50	50	50	150	250	2	A	3.1		

● Ex stock ○ On demand

* With internal cooling

System code > B26

Grade selection > B24

Technical info > B527

Cutting data > B230

Spare parts

Insert	XPHT16	XPHT20	XPHT25	XPHT30	XPHT32	XPHT40	XPHT50		
ØD	16	20	25	30	32	40	50		
	Clamp					CBH5R1	CBH5R1		
	Clamp				WD-208	WD-208			
	Screw (clamp)				I60M5×13 (6.7 Nm)	I60M5×13 (6.7 Nm)	I43M6×16 (9.1 Nm)		I43M6×16 (9.1 Nm)
	Screw (insert)	I60M2.5×6.5 (1.0 Nm)		I60M4×10 (3.4 Nm)	I60M5×13 (6.7 Nm)	I60M5×13 (6.7 Nm)	I43M6×16 (9.1 Nm)		I43M8×21 (16.2 Nm)
	Screw (insert)		I60M3.5×08TT (2.7 Nm)						
	Wrench (clamp)				WT20IT	WT20IT	WT25IT		WT25IT
	Wrench (insert)		WT10IP						
	Wrench (insert)				WT20IT	WT20IT	WT25IT		WT30IT
	Wrench (insert)	WT07P							
	Wrench (insert)			WT15S					

XPHT	L	S	d
16	16	3.18	3.1
20	20	3.97	4
25	25	4.76	4.7
30	30	6.35	5.8
32	32	6.35	5.8
40	40	7.94	6.8
50	50	7.94	9.2

- Ideal machining conditions
- Normal machining conditions
- Unfavourable machining conditions

Milling inserts

XP** milling insert		Material																								
		HC ¹ (CVD)			HC ¹ (PVD)		HT	HC ²	HW																	
		P	M	K	N	S	H																			
	ISO	R	α	YBC302	YBC301	YBC401	YBM253	YBM251	YBM351	YBD152	YBD252	YBG101	YBG102	YBG202	YBG212	YBG203	YBG205	YB9320	YBG302	YBS303	YBG252	YNG151	YNG151C	YD101	YD201	
	XPHT16R0803-GM	8	9																							
	XPHT20R10T3-GM	10	9																							
	XPHT25R1204-GM	12.5	9																							
	XPHT30R1506-GM	15	11																							
	XPHT32R1606-GM	16	9																							
	XPHT40R2007-GM	20	9																							
	XPHT50R2507-GM	25	9																							

● Ex stock ○ On demand

HC¹ Coated carbide
 HT Uncoated cermet
 HC² Coated cermet
 HW Uncoated carbide

System code > B26

Grade selection > B24

Technical info > B527

Cutting data > B230



A

Turning

B

Milling

C

Drilling

D

Technical Information

E

Index

Profile milling

BMR03

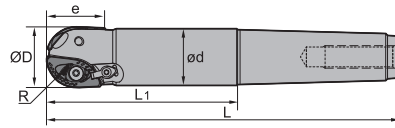
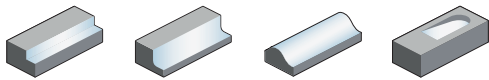

A

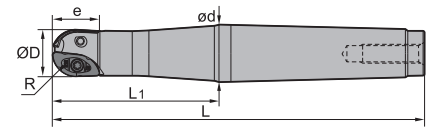

B

Morse taper shank

Article	* Stock	Dimensions [mm]							Teeth	Coupling	kg	Inserts 
		R	ØD	e	ød	L ₁	L					
BMR03-020-MT3-M	○	10	20	20	18.7	70	156	2	B	0.4	XPHT20	
BMR03-020-MT3-L	○	10	20	20	18.7	100	186	2	B	0.4		
BMR03-025-MT3-M	○	12.5	25	25	23.5	70	156	2	B	0.4	XPHT25	
BMR03-025-MT3-L	○	12.5	25	25	23.5	100	186	2	B	0.4		
BMR03-030-MT4-M	○	15	30	30	28.2	70	189	2	A	0.8	XPHT30	
BMR03-030-MT4-L	○	15	30	30	28.2	120	229	2	A	1		
BMR03-032-MT4-M	○	16	32	32	29.2	70	179	2	A	0.9	XPHT32	
BMR03-032-MT4-L	●	16	32	32	29.2	100	209	2	A	0.9		
BMR03-040-MT5-L	○	20	40	40	36.9	90	226	2	A	1.8	XPHT40	
BMR03-050-MT5-M	●	25	50	50	46.8	100	236	2	A	2.2		
BMR03-050-MT5-L	○	25	50	50	46.8	150	286	2	A	2.9	XPHT50	

● Ex stock ○ On demand

* With internal cooling

System code > B26

Grade selection > B24

Technical info > B527

Cutting data > B230

A

Turning

B

Milling

C

Drilling

D

Technical Information

E

Index

Spare parts

Insert	ØD	XPHT20	XPHT25	XPHT30	XPHT32	XPHT40	XPHT50
		20	25	30	32	40	50
	Clamp					CBH5R1	CBH5R1
	Clamp			WD-208	WD-208		
	Screw (clamp)			I60M5×13 (6.7 Nm)	I60M5×13 (6.7 Nm)	I43M6×16 (9.1 Nm)	I43M6×16 (9.1 Nm)
	Screw (insert)		I60M4×10 (3.4 Nm)	I60M5×13 (6.7 Nm)	I60M5×13 (6.7 Nm)	I43M6×16 (9.1 Nm)	I43M8×21 (16.2 Nm)
	Screw (insert)	I60M3.5×08TT (2.7 Nm)					
	Wrench (clamp)			WT20IT	WT20IT	WT25IT	WT25IT
	Wrench (insert)	WT10IP					
	Wrench (insert)			WT20IT	WT20IT	WT25IT	WT30IT
	Wrench (insert)		WT15S				



XPHT	L	S	d
20	20	3.97	4
25	25	4.76	4.7
30	30	6.35	5.8
32	32	6.35	5.8
40	40	7.94	6.8
50	50	7.94	9.2

- Ideal machining conditions
- Normal machining conditions
- Unfavourable machining conditions

Milling inserts

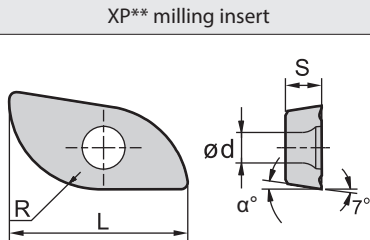

XP** milling insert		HC ¹ (CVD)					HC ¹ (PVD)					HT	HC ²	HW												
		P	M	K	N	S	H																			
	ISO	R	α	YBC302	YBC301	YBC401	YBM253	YBM251	YBM351	YBD152	YBD252	YBG101	YBG102	YBG202	YBG212	YBS203	YBG205	YB9320	YBG302	YBS303	YBG252	YNG151	YNG151C	YD101	YD201	
	XPHT20R10T3-GM	10	9																●							
	XPHT25R1204-GM	12.5	9																●							
	XPHT30R1506-GM	15	11																●							
	XPHT32R1606-GM	16	9																●							
	XPHT40R2007-GM	20	9																●							
	XPHT50R2507-GM	25	9																●							

● Ex stock ○ On demand

HC¹ Coated carbide
 HT Uncoated cermet
 HC² Coated cermet
 HW Uncoated carbide



Profile milling

BMR03

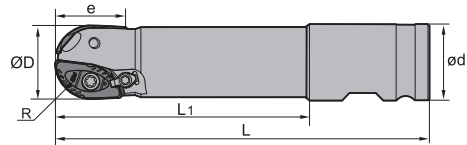
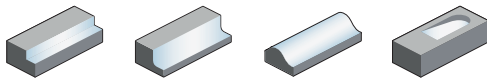

Compound shank

Article	* Stock	Dimensions [mm]							Teeth	kg	Inserts
		R	ØD	e	ød	L ₁	L				
BMR03-040-XPX-M	○	20	40	40	50.8	170	250	2	1.3	XPHT40	
BMR03-040-XPX-L	○	20	40	40	50.8	220	300	2	3.1		
BMR03-040-XPX-XL	○	20	40	40	50.8	270	350	2	3.5		
BMR03-050-XPX-M	○	25	50	50	50.8	170	250	2	3.1	XPHT50	
BMR03-050-XPX-L	○	25	50	50	50.8	200	300	2	3.8		
BMR03-050-XPX-XL	○	25	50	50	50.8	270	350	2	4.4		

● Ex stock ○ On demand

* With internal cooling

Spare parts

	Insert ØD	XPHT40	XPHT50
		40	50
	Clamp	CBH5R1	CBH5R1
	Screw (clamp)	I43M6×16 (9.1 Nm)	I43M6×16 (9.1 Nm)
	Screw (insert)	I43M6×16 (9.1 Nm)	I43M8×21 (16.2 Nm)
	Wrench (clamp)	WT25IT	WT25IT
	Wrench (insert)	WT25IT	WT30IT



System code > B26

Grade selection > B24

Technical info > B527

Cutting data > B230

- Ideal machining conditions
- Normal machining conditions
- Unfavourable machining conditions

XPHT	L	S	d
40	40	7.94	6.8
50	50	7.94	9.2

Milling inserts

XP** milling insert		HC ¹ (CVD)						HC ¹ (PVD)					HT	HC ²	HW										
		P																							
		M																							
		K																							
		N																							
		S																							
		H																							
ISO	R	α	YBC302	YBC301	YBC401	YBM253	YBM251	YBM351	YBD152	YBD252	YBG101	YBG102	YBG202	YBG212	YBS203	YBG205	YB9320	YBG302	YBS303	YBG252	YNG151	YNG151C	YD101	YD201	
	20	9																	●						
	25	9																	●						

● Ex stock ○ On demand

HC¹ Coated carbide
 HT Uncoated cermet
 HC² Coated cermet
 HW Uncoated carbide

A

Turning

B

Milling

C

Drilling

D

Technical Information

E

Index



Profile milling

BMR04

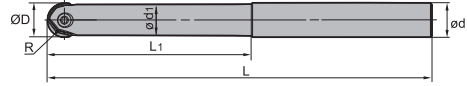
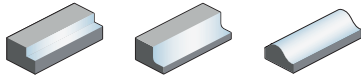

Straight shank

Article	*	Stock	Dimensions [mm]						kg	Inserts
			R	ØD	ød	Ød1	L ₁	L		
BMR04-012-G12-M	●	●	6	12	12	11	35	125	0.1	ZOHX12
BMR04-012-G12-L	●	●	6	12	12	11	45	150	0.1	
BMR04-016-G16-M	●	●	8	16	16	14	40	150	0.2	ZOHX16
BMR04-016-G16-L	●	●	8	16	16	14	55	180	0.3	
BMR04-020-G20-M	●	●	10	20	20	18	65	180	0.4	ZOHX20
BMR04-020-G20-L	●	●	10	20	20	18	100	250	0.6	
BMR04-025-G25-M	●	●	12.5	25	25	23	70	200	0.7	ZOHX25
BMR04-025-G25-L	●	●	12.5	25	25	23	100	250	0.9	
BMR04-030-G32-M	●	●	15	30	32	27	80	250	1.2	ZOHX30
BMR04-030-G32-L	●	●	15	30	32	27	110	300	1.5	
BMR04-032-G32-M	●	●	16	32	32	29	80	250	1.4	ZOHX32
BMR04-032-G32-L	●	●	16	32	32	29	110	300	1.7	

● Ex stock ○ On demand

* With internal cooling

Spare parts							
	Insert	ZOHX12	ZOHX16	ZOHX20	ZOHX25	ZOHX30	ZOHX32
	ØD	12	16	20	25	30	32
	Screw (insert)	I70M4×10TT (3.4 Nm)	I70M5×12TT (6.7 Nm)	I70M5×16TT (6.7 Nm)	I70M6×20TT (9.1 Nm)	I70M8×25TT (16.2 Nm)	I70M8×25TT (16.2 Nm)
	Wrench (insert)	WT15IP	WT20IP	WT20IP	WT20IP		
	Wrench (insert)					WT30IT	WT30IT



System code > B26

Grade selection > B24



Technical info > B527

Cutting data > B230

ZOXX	I.C	S	d
12	12	1.5	4
16	16	4	5
20	20	5	5
25	25	6	6
30	30	7	8
32	32	7	8

- Ideal machining conditions
- ⊗ Normal machining conditions
- ⊗ Unfavourable machining conditions

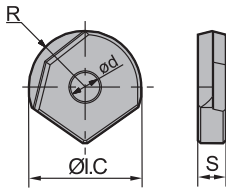
Milling inserts

ZO** milling insert		HC ¹ (CVD)								HC ¹ (PVD)					HT	HC ²	HW							
	P	⊗	⊗	⊗	⊗	⊗	⊗	⊗	⊗	⊗	⊗	⊗	⊗	⊗	⊗	⊗								
	M	⊗	⊗	⊗	⊗	⊗	⊗	⊗	⊗	⊗	⊗	⊗	⊗	⊗	⊗	⊗								
	K									⊗	⊗	⊗	⊗	⊗	⊗	⊗								
	N									⊗	⊗	⊗	⊗	⊗	⊗	⊗								
	S									⊗	⊗	⊗	⊗	⊗	⊗	⊗								
	H																							
ISO	R	YBC302	YBC301	YBC401	YBM253	YBM251	YBM351	YBD152	YBD252	YBG101	YBG102	YBG202	YBG212	YBS203	YBG205	YB9320	YBG302	YBS303	YBG252	YNG151	YNG151C	YD101	YD201	
	ZOXX1203-GF	6																						
	ZOXX1604-GF	8																						
	ZOXX2005-GF	10																						
	ZOXX2506-GF	12.5																						
	ZOXX3007-GF	15																						
	ZOXX3207-GF	16																						
	ZOXX1203-GM	6																						
	ZOXX1604-GM	8																						
	ZOXX2005-GM	10																						
	ZOXX2506-GM	12.5																						
	ZOXX3007-GM	15																						
	ZOXX3207-GM	16																						

● Ex stock ○ On demand

HC¹ Coated carbide
 HT Uncoated cermet
 HC² Coated cermet
 HW Uncoated carbide

System code > B26

Grade selection > B24

Technical info > B527

Cutting data > B230



A

Turning

B

Milling

C

Drilling

D

Technical Information

E

Index

Profile milling

BMR04

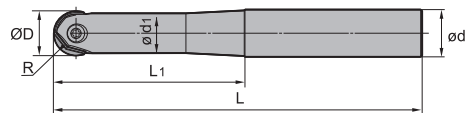

Straight shank

Article	*	Stock	Dimensions [mm]						kg	Inserts
			R	ØD	ød	Ød1	L ₁	L		
BMR04-012-G16-M	●		6	12	16	11	50	125	0.2	ZOHX12
BMR04-012-G16-L	●		6	12	16	11	70	150	0.2	
BMR04-016-G20-M	●		8	16	20	14	60	150	0.3	ZOHX16
BMR04-016-G20-L	●		8	16	20	14	80	180	0.3	
BMR04-020-G25-M	●		10	20	25	18	75	180	0.6	ZOHX20
BMR04-020-G25-L	●		10	20	25	18	95	200	0.6	
BMR04-025-G32-M	●		12.5	25	32	23	90	200	1	ZOHX25
BMR04-025-G32-L	●		12.5	25	32	23	110	250	1.3	
BMR04-030-G40-M	●		15	30	40	27	110	250	2	ZOHX30
BMR04-032-G40-L	●		16	32	40	29	125	300	2.4	

● Ex stock ○ On demand

* With internal cooling

Spare parts

	Insert	ZOHX12	ZOHX16	ZOHX20	ZOHX25	ZOHX30	ZOHX32
		12	16	20	25	30	32
Screw (insert)		I70M4×10TT (3.4 Nm)	I70M5×12TT (6.7 Nm)	I70M5×16TT (6.7 Nm)	I70M6×20TT (9.1 Nm)	I70M8×25TT (16.2 Nm)	I70M8×25TT (16.2 Nm)
Wrench (insert)		WT15IP	WT20IP	WT20IP	WT20IP		
Wrench (insert)						WT30IT	WT30IT



System code > B26

Grade selection > B24



Technical info > B527

Cutting data > B230

ZOHX	I.C	S	d
12	12	1.5	4
16	16	4	5
20	20	5	5
25	25	6	6
30	30	7	8
32	32	7	8

- Ideal machining conditions
- ⊗ Normal machining conditions
- ⊗ Unfavourable machining conditions

Milling inserts

ZO** milling insert		HC ¹ (CVD)								HC ¹ (PVD)					HT	HC ²	HW						
ISO		R	YBC302	YBC301	YBC401	YBM253	YBM251	YBM351	YBD152	YBD252	YBG101	YBG102	YBG202	YBG212	YBS203	YB9320	YBG302	YBS303	YBG252	YNG151	YNG151C	YD101	YD201
	ZOHX1203-GF	6	●	●	●	●	●	●	●	●	●	●	●	●	●	●	●	●	●	●	●		
	ZOHX1604-GF	8																					
	ZOHX2005-GF	10																					
	ZOHX2506-GF	12.5																					
	ZOHX3007-GF	15																					
	ZOHX3207-GF	16																					
	ZOHX1203-GM	6																					
	ZOHX1604-GM	8																					
	ZOHX2005-GM	10																					
	ZOHX2506-GM	12.5																					
	ZOHX3007-GM	15																					
	ZOHX3207-GM	16																					

● Ex stock ○ On demand

HC¹ Coated carbide
 HT Uncoated cermet
 HC² Coated cermet
 HW Uncoated carbide

A

Turning

B

Milling

C

Drilling

D

Technical Information

E

Index



Notes

A

Turning

B

Milling

C

Drilling

D

Technical
Information

E

Index

Slot milling

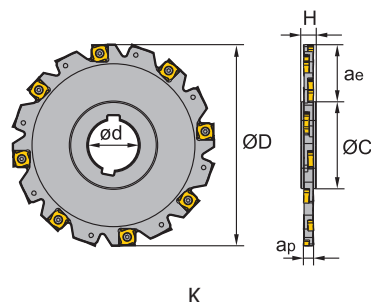

Article	*	Stock	Dimensions [mm]						Coupling	kg	Inserts
			ØD	ød	Øc	H	ap	ae max			
SMP01-100x4-K27-SN12-10		○	100	27	45	12	4	25	K	0.2	XSEQ1202
SMP01-125x4-K40-SN12-12		○	125	40	56	12	4	32	K	0.3	
SMP01-160x4-K40-SN12-16		●	160	40	67	12	4	44	K	0.5	XSEQ1203
SMP01-100x5-K27-SN12-10		○	100	27	45	12	5	25	K	0.2	
SMP01-125x5-K40-SN12-12		○	125	40	56	12	5	32	K	0.3	XSEQ1204
SMP01-160x5-K40-SN12-16		○	160	40	67	12	5	44	K	0.6	
SMP01-100x7-K27-SN12-10		○	100	27	45	12	7	25	K	0.3	XSEQ1204
SMP01-125x7-K40-SN12-12		○	125	40	56	12	7	32	K	0.4	
SMP01-160x7-K40-SN12-16		○	160	40	67	12	7	44	K	0.8	XSEQ1204
SMP01-200x7-K50-SN12-18		○	200	50	71	12	7	62	K	1.2	
SMP01-250x7-K50-SN12-24		○	250	50	71	12	7	87	K	1.9	XSEQ12T3
SMP01-100x6-K27-SN12-10		○	100	27	45	12	6	25	K	0.3	
SMP01-125x6-K40-SN12-12		○	125	40	56	12	6	32	K	0.4	XSEQ12T3
SMP01-160x6-K40-SN12-16		○	160	40	67	12	6	44	K	0.7	
SMP01-200x6-K50-SN12-18		○	200	50	71	12	6	62	K	1.1	XSEQ12T3
SMP01-250x6-K50-SN12-24		○	250	50	71	12	6	87	K	1.7	
SMP01-315x6-K50-SN12-32		○	315	50	72	11.15	6	119.6	K	2.9	XSEQ12T4
SMP01-100x8-K27-SN12-10		○	100	27	45	12	8	25	K	0.3	
SMP01-125x8-K40-SN12-12		○	125	40	56	12	8	32	K	0.5	XSEQ12T4
SMP01-160x8-K40-SN12-16		○	160	40	67	12	8	44	K	0.9	
SMP01-200x8-K50-SN12-18		○	200	50	71	12	8	62	K	1.4	XSEQ12T4
SMP01-250x8-K50-SN12-24		○	250	50	71	12	8	87	K	2.2	

● Ex stock ○ On demand

* With internal cooling

System code > B26

Grade selection > B24

Technical info > B527



Cutting data > B230



Indexable milling Slot milling

A

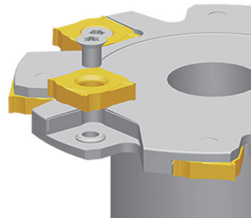
Turning

Spare parts						
Insert	XSEQ1202	XSEQ1203	XSEQ1204	XSEQ12T3	XSEQ12T4	
ØD	63-160	63-160	63-250	63-360	63-250	
 Screw (insert)	I91M4×3.2X (3.4 Nm)	I91M4×3.2X (3.4 Nm)	I91M4×6.1X (3.4 Nm)	I91M4×5.1X (3.4 Nm)	I91M4×7.1X (3.4 Nm)	
 Wrench (insert)	WT08IP	WT08IP	WT08IP	WT08IP	WT08IP	











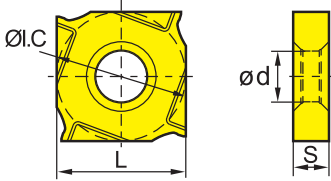

















B

Milling

XSEQ	L	I.C	S	d
12 02	12.7	12.7	2.3	5
12 03	12.7	12.7	3	5
12 T3	12.7	12.7	3.5	5
12 04	12.7	12.7	4	5
12 T4	12.7	12.7	4.5	5

- Ideal machining conditions
- ⊗ Normal machining conditions
- ⊗ Unfavourable machining conditions

Milling inserts

XS** milling insert	HC ¹ (CVD)						HC ¹ (PVD)				HT	HC ²	HW																
	P	M	K	N	S	H	YBC302	YBC301	YBC401	YBM253	YBM251	YBM351	YBD152	YBD252	YBG101	YBG102	YBG202	YBG212	YBS203	YBG205	YB9320	YBG302	YBS303	YBG252	YNG151	YNG151C	YD101	YD201	
																													
ISO																													
	XSEQ1202																												
	XSEQ1203	○	●																										
	XSEQ1204																												
	XSEQ12T3		●																										○
	XSEQ12T4																												

● Ex stock ○ On demand

HC¹ Coated carbide
HT Uncoated cermet
HC² Coated cermet
HW Uncoated carbide

C

Drilling

D

Technical Information

E

Index

System code > B26

Grade selection > B24

Technical info > B527

Cutting data > B230

Slot milling

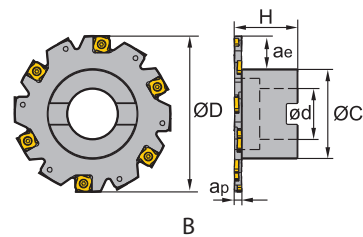
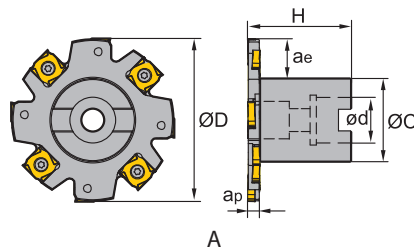
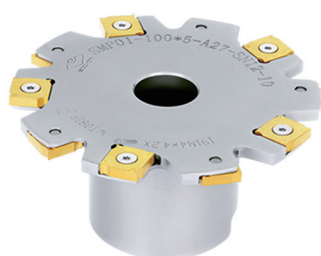

Article	* Stock	Dimensions [mm]							Teeth	Coupling	kg	Inserts
		ØD	ød	Øc	H	ap	ae,max					
SMP01-063x4-A22-SN12-06	○	63	22	32	40	4	14	6	A	0.2	XSEQ1202	
SMP01-080x4-A22-SN12-08	○	80	22	40	40	4	18	8	A	0.4		
SMP01-100x4-A27-SN12-10	○	100	27	48	50	4	23	10	A	0.6		
SMP01-063x5-A22-SN12-06	○	63	22	32	40	5	14	6	A	0.2	XSEQ1203	
SMP01-080x5-A22-SN12-08	○	80	22	40	40	5	18	8	A	0.4		
SMP01-100x5-A27-SN12-10	○	100	27	48	50	5	23	10	A	0.7		
SMP01-063x7-A22-SN12-06	○	63	22	32	40	7	14	6	A	0.2	XSEQ1204	
SMP01-080x7-A22-SN12-08	○	80	22	40	40	7	18	8	A	0.5		
SMP01-100x7-A27-SN12-10	○	100	27	48	50	7	23	10	A	0.7		
SMP01-125x7-B40-SN12-12	○	125	40	72	50	7	23	12	B	1.1	XSEQ12T3	
SMP01-160x7-B40-SN12-16	○	160	40	70	60	7	41	16	B	1.4		
SMP01-063x6-A22-SN12-06	○	63	22	32	40	6	14	6	A	0.2		
SMP01-080x6-A22-SN12-08	○	80	22	40	40	6	18	8	A	0.5	XSEQ12T4	
SMP01-100x6-A27-SN12-10	○	100	27	48	50	6	23	10	A	0.7		
SMP01-125x6-B40-SN12-12	○	125	40	72	50	6	23	12	B	1		
SMP01-160x6-B40-SN12-16	○	160	40	70	60	6	41	16	B	1.3		
SMP01-063x8-A22-SN12-06	○	63	22	32	40	8	14	6	A	0.2	XSEQ12T4	
SMP01-080x8-A22-SN12-08	○	80	22	40	40	8	18	8	A	0.5		
SMP01-100x8-A27-SN12-10	○	100	27	48	50	8	23	10	A	0.8		
SMP01-125x8-B40-SN12-12	○	125	40	72	50	8	23	12	B	1.1		
SMP01-160x8-B40-SN12-16	○	160	40	70	60	8	41	16	B	1.5		

● Ex stock ○ On demand

* With internal cooling

System code > B26

Grade selection > B24

Technical info > B527



Cutting data > B230



Indexable milling Slot milling

A

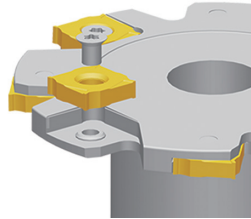
Turning

Spare parts						
Insert	XSEQ1202	XSEQ1203	XSEQ1204	XSEQ12T3	XSEQ12T4	
ØD	63-160	63-160	63-250	63-250	63-250	
 Screw (insert)	I91M4×3.2X (3.4 Nm)	I91M4×3.2X (3.4 Nm)	I91M4×6.1X (3.4 Nm)	I91M4×5.1X (3.4 Nm)	I91M4×7.1X (3.4 Nm)	
 Wrench (insert)	WT08IP	WT08IP	WT08IP	WT08IP	WT08IP	

B

Milling



Milling inserts

- Ideal machining conditions
- ⊗ Normal machining conditions
- ⊗ Unfavourable machining conditions

XSEQ	L	I.C	S	d
12 02	12.7	12.7	2.3	5
12 03	12.7	12.7	3	5
12 T3	12.7	12.7	3.5	5
12 04	12.7	12.7	4	5
12 T4	12.7	12.7	4.5	5

C

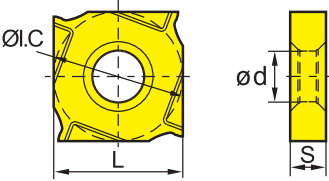
Drilling

XS** milling insert	HC ¹ (CVD)						HC ¹ (PVD)				HT	HC ²	HW																
	P	M	K	N	S	H	YBC302	YBC301	YBC401	YBM253	YBM251	YBM351	YBD152	YBD252	YBG101	YBG102	YBG202	YBG212	YBS203	YBG205	YB9320	YBG302	YBS303	YBG252	YNG151	YNG151C	YD101	YD201	
	●	●	●	●	●	●	●	●	●	●	●	●	●	●	●	●	●	●	●	●	●	●	●	●	●	●	●	●	●
ISO																													
	XSEQ1202																					○							
	XSEQ1203	○	●																			●							
	XSEQ1204																						●						
	XSEQ12T3		●																				●					○	
	XSEQ12T4																						●						

● Ex stock ○ On demand

HC¹ Coated carbide
 HT Uncoated cermet
 HC² Coated cermet
 HW Uncoated carbide

D

Technical Information

E

Index

System code > B26

Grade selection > B24

Technical info > B527

Cutting data > B230

Slot milling

SMP03 Kr: 90°

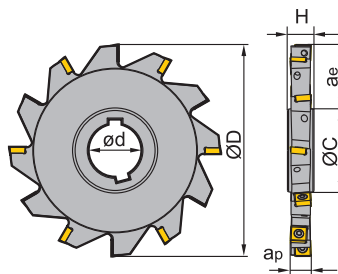
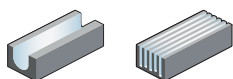

K

Article	* Stock	Dimensions [mm]							Teeth	Coupling	kg	Inserts
		ØD	Ød	Øc	H	ap	ae,max					
SMP03-080x8-K27-MP06-10	○	80	27	44	12	8	17.6	10	K	0.2	MPHT0603	
SMP03-100x8-K32-MP06-14	○	100	32	49	12	8	25.1	14	K	0.3		
SMP03-100x10-K32-MP06-14	○	100	32	49	14	10	25.1	14	K	0.4		
SMP03-125x10-K40-MP06-16	○	125	40	57	14	10	33.6	16	K	0.6	MPHT0803	
SMP03-125x12-K40-MP08-12	○	125	40	58.3	16	12	32.6	12	K	0.7		
SMP03-160x12-K40-MP08-14	○	160	40	64.3	16	12	31.5	14	K	1.3		
SMP03-160x16-K40-MP12-12	○	160	40	64.6	20	16	47.6	12	K	1.6	MPHT1204	
SMP03-160x18-K40-MP12-12	○	160	40	65.3	24	18	47.3	12	K	1.9		
SMP03-160x20-K40-MP12-12	○	160	40	65.3	26	20	47.3	12	K	2.1		
SMP03-200x16-K50-MP12-14	○	200	50	74.6	20	16	62.6	14	K	2.5		
SMP03-200x18-K50-MP12-14	○	200	50	75.3	24	18	62.3	14	K	2.9		
SMP03-200x20-K50-MP12-14	○	200	50	75.3	26	20	62.3	14	K	3.3		

● Ex stock ○ On demand

* With internal cooling

Spare parts					
	Insert	MPHT0603	MPHT0803	MPHT1204	
	ØD	80-125	125-160	160-200	
	Screw (insert)	I60M2.5x6.5 (1.0 Nm)	I60M3x7 (1.8 Nm)	I60M5x13 (6.7 Nm)	
	Wrench (insert)	WT07IP	WT09IP		
	Wrench (insert)			WT20IS	

System code > B26

Grade selection > B24

Technical info > B527

Cutting data > B230

A

Turning

B

Milling

C

Drilling

D

Technical Information

E

Index

- Ideal machining conditions
- Normal machining conditions
- Unfavourable machining conditions

MPHT	L	I.C	S	d
06 03	6.35	6.35	3.18	2.8
08 03	8.3	8.3	3.18	3.4
12 04	12.7	12.7	4.76	5.56

Milling inserts

MP** milling insert		HC ¹ (CVD)						HC ¹ (PVD)						HT	HC ²	HW								
	P	●	●	●	●	●	●	●	●	●	●	●	●	●	●									
	M	●	●	●	●	●	●	●	●	●	●	●	●	●	●									
	K					●	●	●								●								
	N							●							●	●								
	S		●	●				●	●	●	●	●	●											
	H																							
ISO		r	YBC302	YBC301	YBC401	YBM253	YBM251	YBM351	YBD152	YBD252	YBG101	YBG102	YBG202	YBG212	YBS203	YBG205	YB9320	YBG302	YBS303	YBG252	YNG151	YNG151C	YD101	YD201
	MPHT060304-DM	0.4	●			●												●						
	MPHT080305-DM	0.5	●			○													●					
	MPHT120408-DM	0.8	●			○		●											●					

● Ex stock ○ On demand

HC¹ Coated carbide
 HT Uncoated cermet
 HC² Coated cermet
 HW Uncoated carbide



Slot milling

SMP03 Kr: 90°

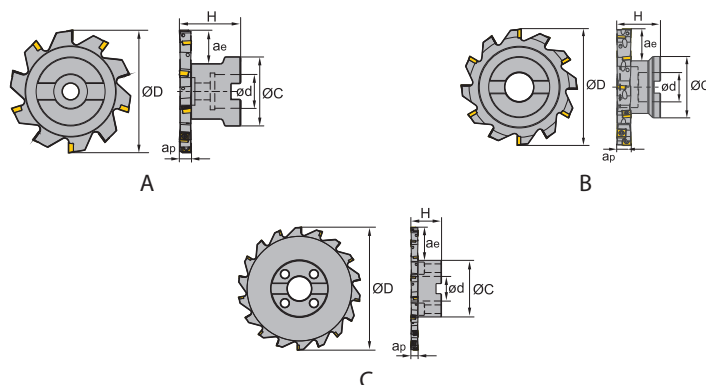
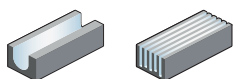





Article	* Stock	Dimensions [mm]							Teeth	Coupling	kg	Inserts
		ØD	ød	Øc	H	ap	ae _{max}					
SMP03-080x8-A22-MP06-10	○	80	22	45	40	8	21	10	A	0.4	MPHT0603	
SMP03-100x8-B27-MP06-14	○	100	27	55	40	8	24.5	14	B	0.6		
SMP03-100x10-B27-MP06-14	●	100	27	55	40	10	24.5	14	B	0.7		
SMP03-125x10-B32-MP06-16	○	125	32	65	45	10	33.3	16	B	1.1	MPHT0803	
SMP03-125x12-B32-MP08-12	○	125	32	65	45	12	33	12	B	1.4		
SMP03-160x12-B40-MP08-14	○	160	40	80	50	12	44	14	B	1.9		
SMP03-200x12-C40-MP08-18	○	200	40	92	50	12	52	18	C	3.2	MPHT1204	
SMP03-125x16-B32-MP12-10	○	125	32	65	50	16	33	10	B	2.3		
SMP03-160x16-B40-MP12-12	○	160	40	80	60	16	45	12	B	2.3		
SMP03-160x18-B40-MP12-12	○	160	40	80	60	18	45	12	B	2.4	MPHT1204	
SMP03-200x16-C40-MP12-14	○	200	40	92	50	16	52	14	C	3.6		
SMP03-200x18-C40-MP12-14	○	200	40	92	50	18	52	14	C	3.9		
SMP03-200x20-C40-MP12-14	○	200	40	92	50	20	52	14	C	4.2		

● Ex stock ○ On demand

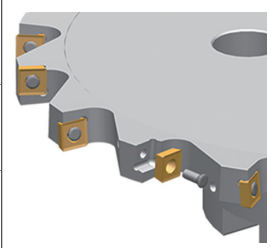
* With internal cooling

Spare parts

	Insert ØD	MPHT0603 80-125	MPHT0803 125-200	MPHT1204 125-200	
	Screw (insert)	I60M2.5x6.5 (1.0 Nm)	I60M3x7 (1.8 Nm)	I60M5x13 (6.7 Nm)	
	Wrench (insert)	WT07IP	WT09IP		
	Wrench (insert)			WT20IS	

System code > B26

Grade selection > B24

Technical info > B527

Cutting data > B230

A

Turning

B

Milling

C



Drilling

D

Technical Information



E

Index

-  Ideal machining conditions
-  Normal machining conditions
-  Unfavourable machining conditions

MPHT	L	I.C	S	d
06 03	6.35	6.35	3.18	2.8
08 03	8.3	8.3	3.18	3.4
12 04	12.7	12.7	4.76	5.56

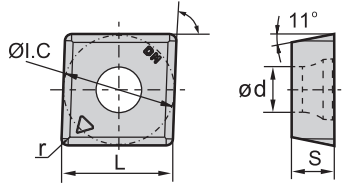
Milling inserts

MP** milling insert		HC ¹ (CVD)						HC ¹ (PVD)						HT	HC ²	HW								
	P																							
	M																							
	K																							
	N																							
	S																							
	H																							
ISO	r	YBC302	YBC301	YBC401	YBM253	YBM251	YBM351	YBD152	YBD252	YBG101	YBG102	YBG202	YBG212	YBS203	YBG205	YB9320	YBG302	YBS303	YBG252	YNG151	YNG151C	YD101	YD201	
	MPHT060304-DM	0.4	●			●											●							
	MPHT080305-DM	0.5	●			○											●							
	MPHT120408-DM	0.8	●			○		●									●							

● Ex stock ○ On demand

HC¹ Coated carbide
 HT Uncoated cermet
 HC² Coated cermet
 HW Uncoated carbide



Slot milling

SMP05 Kr: 90°

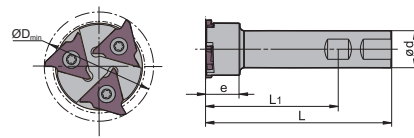
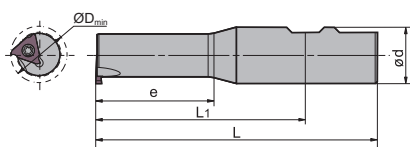
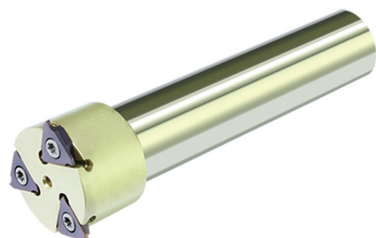
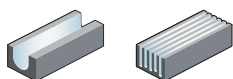

A



B

Article	*	Stock	Dimensions [mm]					Teeth	Coupling	Inserts
			e	ØDmin	ød	L ₁	L			
SMP05-025x3.0-XP25-QC16-01	●		40	25	25	89	125	1	A	 QC16L
SMP05-039x3.0-XP25-QC16-03	●		23	39	25	89	125	3	B	
SMP05-044x4.8-XP25-QC22-03	●		23	44	25	89	125	3	B	

● Ex stock ○ On demand

* With internal cooling

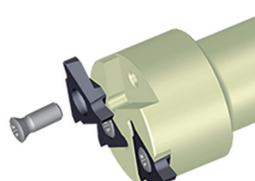
Spare parts

Insert		QC16L	QC16L	QC22L	
ØD		25	39	44	
	Screw (insert)	I60M3.5×10 (2.7 Nm)	I60M3.5×10 (2.7 Nm)	I60M5×13 (6.7 Nm)	
	Wrench (insert)	WT15IP	WT15IP	WT20IP	

A

Turning

B

Milling

C

Drilling

D



Technical Information

E











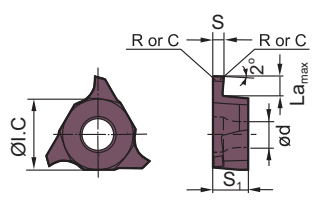



















































































Index

Indexable milling Slot milling

Milling inserts

-  Ideal machining conditions
-  Normal machining conditions
-  Unfavourable machining conditions

QC16	I.C	d
16	9.525	4.4
22	12.7	5.5

QC** turning/milling insert				HC ¹ (CVD)						HC ¹ (PVD)						HT	HC ²	HW							
				P																					
				M																					
				K																					
				N																					
				S																					
				H																					
ISO	S±0.025	La _{max}	R/C	YBC302	YBC301	YBC401	YBM253	YBM251	YBM351	YBD152	YBD252	YBG101	YBG102	YBG202	YBG212	YBS203	YBG205	YB9320	YBG302	YBS303	YBG252	YNG151	YNG151C	YD101	YD201
QC16L075-R01	0.75	2	0.1														○								
QC16L095-R01	0.95	2	0.1														○								
QC16L100-R01	1	2	0.1														○								
QC16L110-R01	1.1	2	0.1											○			●								
QC16L120-R01	1.2	2	0.1														○								
QC16L125-R02	1.25	2	0.2														●								
QC16L130-R02	1.3	2	0.2														○								
QC16L145-R02	1.45	2	0.2														●								
QC16L150-R02	1.5	2	0.2														○								
QC16L160-R02	1.6	2	0.2														●								
QC16L165-R02	1.65	2	0.2														○								
QC16L170-R02	1.7	2	0.2														○								
QC16L175-R02	1.75	2	0.2														○								
QC16L185-R02	1.85	2.5	0.2														○								
QC16L200-R02	2	2.5	0.2														●								
QC16L210-R02	2.1	2.5	0.2														○								
QC16L210-R05	2.1	2.5	0.5														○								
QC16L220-R02	2.2	2.5	0.2														○								
QC16L250-R02	2.5	2.5	0.2														●								
QC16L300-R02	3	3	0.2														●								

● Ex stock ○ On demand

HC¹ Coated carbide
 HT Uncoated cermet
 HC² Coated cermet
 HW Uncoated carbide

A

Turning

B

Milling

C

Drilling

D

Technical Information

E

Index



Milling inserts

- Ideal machining conditions
- ⊗ Normal machining conditions
- ⊗ Unfavourable machining conditions

QC16	I.C	d
16	9.525	4.4
22	12.7	5.5

QC** turning/milling insert				HC ¹ (CVD)						HC ¹ (PVD)						HT	HC ²	HW							
				P	⊗	⊗	⊗	⊗	⊗	⊗	⊗	⊗	⊗	⊗	⊗	⊗	⊗	●	●	●					
				M	⊗	⊗	⊗	⊗	⊗	⊗	⊗	⊗	⊗	⊗	⊗	⊗	⊗	⊗	●	●	●				
				K	⊗	⊗	⊗	⊗	⊗	⊗	⊗	⊗	⊗	⊗	⊗	⊗	⊗	⊗	⊗	●	●	●			
				N	⊗	⊗	⊗	⊗	⊗	⊗	⊗	⊗	⊗	⊗	⊗	⊗	⊗	⊗	⊗	●	●	●			
				S	⊗	⊗	⊗	⊗	⊗	⊗	⊗	⊗	⊗	⊗	⊗	⊗	⊗	⊗	⊗	●	●	●			
				H	⊗	⊗	⊗	⊗	⊗	⊗	⊗	⊗	⊗	⊗	⊗	⊗	⊗	⊗	⊗	●	●	●			
ISO	S±0.025	La _{max}	R/C	YBC302	YBC301	YBC401	YBM253	YBM251	YBM351	YBD152	YBD252	YBG101	YBG102	YBG202	YBG212	YBS203	YBG205	YB9320	YBG302	YBS303	YBG252	YNG151	YNG151C	YD101	YD201
QC22L100-R02	1	2	0.2														○								
QC22L125-R02	1.25	2	0.2														○								
QC22L145-R02	1.45	2	0.2														○								
QC22L150-R02	1.5	3.5	0.2														○								
QC22L175-R02	1.75	3.5	0.2														○								
QC22L185-R02	1.85	3.5	0.2														○								
QC22L200-R02	2	3.5	0.2														○								
QC22L230-R02	2.3	3.5	0.2														○								
QC22L250-R03	2.5	4	0.3														○								
QC22L265-R03	2.65	4	0.3														●								
QC22L280-R03	2.8	4	0.3														○								
QC22L300-R03	3	4	0.3														○								
QC22L320-R03	3.2	4	0.3														○								
QC22L330-R03	3.3	4	0.3														○								
QC22L350-R03	3.5	5	0.3														○								
QC22L400-R04	4	5	0.4														●								
QC22L430-R04	4.3	5	0.4										○				○								
QC22L450-R04	4.5	5	0.4														○							○	
QC22L480-R04	4.8	5	0.4														○								

● Ex stock ○ On demand

HC¹ Coated carbide
 HT Uncoated cermet
 HC² Coated cermet
 HW Uncoated carbide

A

Turning

B

Milling

C

Drilling

D

Technical Information

E

Index



Notes

A

Turning

B

Milling

C

Drilling

D

Technical
Information

E

Index

High feed milling

XMR01 Kr: 15°

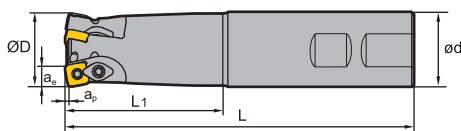
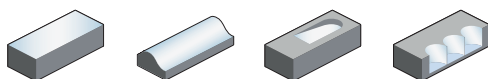

S type insert, Weldon shank

Article	*	Stock	Dimensions [mm]						Teeth	kg	Inserts
			ØD	ød	ap	ae	L ₁	L			
XMR01-020-XP20-SD06-04C	*	○	20	20	0.8	5.8	50	130	4	0.24	SDMT06T2
XMR01-025-XP25-SD06-03C	*	○	25	25	0.8	5.8	60	140	3	0.46	
XMR01-025-XP25-SD06-05C	*	○	25	25	0.8	5.8	60	140	5	0.44	
XMR01-032-XP32-SD06-06C	*	○	32	32	0.8	5.8	70	150	6		SDMT09T3
XMR01-025-XP25-SD09-02		○	25	25	1.4	8.8	60	140	2	0.5	
XMR01-032-XP32-SD09-03C	*	○	32	32	1.4	8.8	70	150	3	0.8	
XMR01-035-XP32-SD09-03		○	35	32	1.4	8.8	70	150	3	0.8	SDMT1204
XMR01-040-XP40-SD12-03		○	40	40	1.8	11.7	70	150	3	1.3	
XMR01-040-XP40-SD12-03C	*	○	40	40	1.8	11.7	70	150	3	1.2	
XMR01-040-XP40-SD15-02		○	40	40	2.2	14	70	200	2	1.6	SDMT1505

● Ex stock ○ On demand

* With internal cooling

Spare parts		SDMT06T2	SDMT09T3	SDMT1204	SDMT1505	
Insert	ØD	20-63	25-63	32-100	40-160	
Clamp			WD-204	WD-204	WD-208	
Screw (clamp)			I60M4×8.4 (3.4 Nm)	I60M4×8.4 (3.4 Nm)	I60M5×13 (6.7 Nm)	
Screw (insert)		I60M2.2×5.5 (0.8 Nm)		I60M4×8.4 (3.4 Nm)	I60M5×13 (6.7 Nm)	
Screw (insert)			I60M3.5×08TT (2.7 Nm)			
Wrench (clamp)			WT15IP	WT15IP	WT20IP	
Wrench (insert)		WT07IP	WT10IP	WT15IP	WT20IP	

A

Turning

B

Milling

C

Drilling



D

Technical Information



E

Index

SDMT	L	I.C	S	d
06 T2	6.35	6.35	2.58	5.5
09 T3	9.525	9.525	3.97	4
12 04	12.7	12.7	4.76	4.4
15 05	15.875	15.875	5.56	5.5

-  Ideal machining conditions
-  Normal machining conditions
-  Unfavourable machining conditions

Milling inserts

SD** milling insert			HC ¹ (CVD)						HC ¹ (PVD)					HT	HC ²	HW											
			P	M	K	N	S	H																			
ISO			r	α	YBC302	YBC301	YBC401	YBM253	YBM251	YBM351	YBD152	YBD252	YBG101	YBG102	YBG202	YBG212	YBS203	YBG205	YB9320	YBG302	YBS303	YBG252	YNG151	YNG151C	YD101	YD201	
	SDMT06T208-DM	0.8	15						○						○												
	SDMT09T312-DM	1.2	15	●				●							○						●						
	SDMT120412-DM	1.2	15	●				●			●				○	○											
	SDMT150520-DM	2	15												○												
	SDMT09T312-NM						●									○	●				●						
	SDMT120412-NM						●									○	●		●		●						
	SDMT06T208-PM	0.8	15	●			●										○	●			○						
	SDMT09T312-PM	1.2	15				●				○			○			●										
	SDMT120412-PM	1.2	15				●							○			●										
	SDMT150520-PM	2	15				○											○									

● Ex stock ○ On demand

HC¹ Coated carbide
 HT Uncoated cermet
 HC² Coated cermet
 HW Uncoated carbide

System code > B26

Grade selection > B24

Technical info > B527

Cutting data > B230

High feed milling

XMR01 Kr: 15°

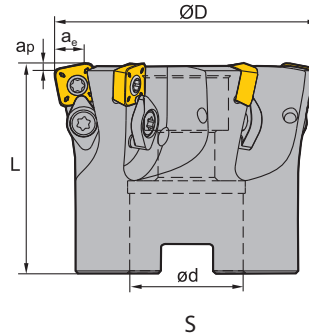
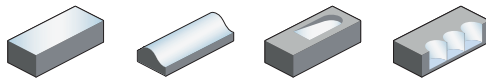

Article	*	Stock	Dimensions [mm]					Teeth	Coupling	kg	Inserts
			ØD	ød	ap	ae	L				
XMR01-040-A16-SD06-07C	*	○	40	16	0.8	5.8	40	7	A	0.178	SDMT06T2
XMR01-050-A22-SD06-07C	*	○	50	22	0.8	5.8	40	7	A	0.36	
XMR01-050-A22-SD06-08C	*	○	50	22	0.8	5.8	40	8	A	0.36	
XMR01-063-A22-SD06-10C	*	○	63	22	0.8	5.8	40	10	A	0.53	
XMR01-063-A27-SD06-10C	*	○	63	27	0.8	5.8	50	10	A	0.57	SDMT09T3
XMR01-040-A16-SD09-04		○	40	16	1.4	8.8	40	4	A	0.182	
XMR01-040-A16-SD09-04C	*	○	40	16	1.4	8.8	40	4	A	0.182	
XMR01-040-A16-SD09-05		○	40	16	1.4	8.8	40	5	A	0.181	
XMR01-050-A22-SD09-04C	*	●	50	22	1.4	8.8	40	4	A	0.3	SDMT1204
XMR01-050-A22-SD09-05C	*	○	50	22	1.4	8.8	40	5	A	0.3	
XMR01-063-A22-SD09-06C	*	●	63	22	1.4	8.8	40	6	A	0.5	
XMR01-063-A27-SD09-06C	*	○	63	27	1.4	8.8	50	6	A	0.6	
XMR01-063-A22-SD09-07C	*	●	63	22	1.4	8.8	40	7	A	0.44	SDMT1204
XMR01-063-A27-SD09-07C	*	○	63	27	1.4	8.8	50	7	A	0.6	
XMR01-050-A22-SD12-03C	*	○	50	22	1.8	11.7	40	3	A	0.5	
XMR01-050-A22-SD12-04C	*	●	50	22	1.8	11.7	40	4	A	0.5	
XMR01-052-A22-SD12-04C	*	○	52	22	1.8	11.7	40	4	A	0.56	SDMT1204
XMR01-052-A22-SD12-05C	*	○	52	22	1.8	11.7	40	5	A	0.56	
XMR01-063-A22-SD12-05C	*	●	63	22	1.8	11.7	40	5	A	0.55	
XMR01-063-A27-SD12-05C	*	●	63	27	1.8	11.7	50	5	A	0.55	
XMR01-063-A22-SD12-06C	*	●	63	22	1.8	11.7	50	6	A	0.56	SDMT1204
XMR01-066-A27-SD12-05C	*	○	66	27	1.8	11.7	50	5	A	0.56	
XMR01-080-A27-SD12-05C	*	●	80	27	1.8	11.7	63	5	A	0.9	
XMR01-080-A27-SD12-06C	*	●	80	27	1.8	11.7	50	6	A	0.9	
XMR01-080-A27-SD12-07C	*	●	80	27	1.8	11.7	50	7	A	0.93	SDMT1204
XMR01-080-A27-SD12-08C	*	●	80	27	1.8	11.7	50	8	A	0.92	
XMR01-100-B32-SD12-06		●	100	32	1.8	11.7	50	6	B	1.8	
XMR01-100-B32-SD12-06C	*	●	100	32	1.8	11.7	50	6	B	1.8	

● Ex stock ○ On demand

* With internal cooling

Indexable milling

A

Turning







Article	*	Stock	Dimensions [mm]					Teeth	Coupling		Inserts
			ØD	ød	a _p	ae	L				
XMR01-100-B32-SD12-07C	*	●	100	32	1.8	11.7	50	7	B		
XMR01-125-B40-SD12-08C	*	●	125	40	1.8	11.7	63	8	B		SDMT1204
XMR01-125-B40-SD12-09C	*	●	125	40	1.8	11.7	63	9	B		
XMR01-063-A22-SD15-04C	*	○	63	22	2.2	14	40	4	A		
XMR01-100-B32-SD15-07		○	100	32	2.2	14	50	7	B	1.2	SDMT1505
XMR01-125-B40-SD15-09		○	125	40	2.2	14	63	9	B	2.9	

● Ex stock ○ On demand

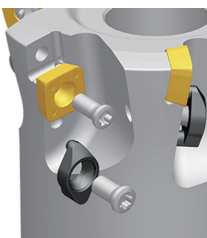
* With internal cooling

B

Milling

Spare parts						
	Insert	SDMT06T2	SDMT09T3	SDMT1204	SDMT1505	
	ØD	20-63	25-63	32-160	40-160	
	Clamp		WD-204	WD-204	WD-208	
	Screw (clamp)		I60M4×8.4 (3.4 Nm)	I60M4×8.4 (3.4 Nm)	I60M5×13 (6.7 Nm)	
	Screw (insert)	I60M2.2×5.5 (0.8 Nm)		I60M4×8.4 (3.4 Nm)	I60M5×13 (6.7 Nm)	
	Screw (insert)		I60M3.5×08TT (2.7 Nm)			
	Wrench (clamp)		WT15IP	WT15IP	WT20IP	
	Wrench (insert)	WT07IP	WT10IP	WT15IP	WT20IP	

C

Drilling

D

Technical Information

E

Index

System code > B26

Grade selection > B24

Technical info > B527

Cutting data > B230

SDMT	L	I.C	S	d
06 T2	6.35	6.35	2.58	5.5
09 T3	9.525	9.525	3.97	4
12 04	12.7	12.7	4.76	4.4
15 05	15.875	15.875	5.56	5.5

- Ideal machining conditions
- Normal machining conditions
- Unfavourable machining conditions

Milling inserts

SD** milling insert		HC ¹ (CVD)						HC ¹ (PVD)					HT	HC ²	HW										
		P	M	K	N	S	H																		
	ISO	r	α	YBC302	YBC301	YBC401	YBM253	YBM251	YBM351	YBD152	YBD252	YBG101	YBG102	YBG202	YBG212	YBS203	YBG205	YB9320	YBG302	YBS303	YBG252	YNG151	YNG151C	YD101	YD201
	SDMT06T208-DM	0.8	15					○						○	○										
	SDMT09T312-DM	1.2	15	●				●						○	○					●					
	SDMT120412-DM	1.2	15	●				●		●				○	○										
	SDMT150520-DM	2	15											○											
	SDMT09T312-NM						●								○	●				●					
	SDMT120412-NM						●								○	●	●	●		●					
	SDMT06T208-PM	0.8	15	●		●									○	●				○					
	SDMT09T312-PM	1.2	15				●			○				○		●									
	SDMT120412-PM	1.2	15				●						○		●										
	SDMT150520-PM	2	15				○								○										

● Ex stock ○ On demand

HC¹ Coated carbide
 HT Uncoated cermet
 HC² Coated cermet
 HW Uncoated carbide

A

Turning

B

Milling

C

Drilling

D

Technical Information

E

Index



High feed milling

XMR01 Kr: 11°-22°

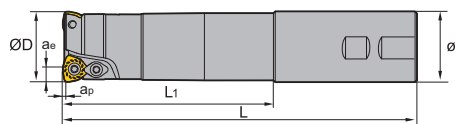
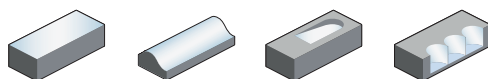

W type insert, Weldon shank

Article	*	Stock	Dimensions [mm]						Teeth	kg	Inserts
			ØD	ød	ap	ae	L ₁	L			
XMR01-020-XP20-WP05-02C-M	*	○	20	20	1.5	3.8	50	130	2	0.2	WPGT0503
XMR01-020-XP20-WP05-02-L		○	20	20	1.5	3.8	100	180	2	0.3	
XMR01-020-XP20-WP05-02-XL		○	20	20	1.5	3.8	130	250	2	0.8	
XMR01-025-XP25-WP06-02C-M	*	○	25	25	1.5	4.35	60	140	2	0.4	WPGT0604
XMR01-025-XP25-WP06-02-L		○	25	25	1.5	4.35	120	200	2	0.6	
XMR01-025-XP25-WP06-02-XL		○	25	25	1.5	4.35	180	300	2	1	
XMR01-032-XP32-WP06-03C-M	*	○	32	32	1.5	4.35	70	150	3	0.8	WPGT0604
XMR01-032-XP32-WP06-03-L		○	32	32	1.5	4.35	120	200	3	1	
XMR01-032-XP32-WP06-03-XL		○	32	32	1.5	4.35	180	300	3	1.6	
XMR01-040-XP32-WP06-03C-M	*	○	40	32	1.5	4.35	50	150	3	0.9	WPGT0604
XMR01-040-XP32-WP06-03-XL		○	40	32	1.5	4.35	50	300	3	1.8	

● Ex stock ○ On demand

* With internal cooling

Variable lead angle (lead angle ist hier dependent on size of inserts)
lead angle: WPGT05: 16°; WPGT06: 22°; WPGT08: 11°; WPGT09: 21°

Spare parts			
	Insert	WPGT0503	WPGT0604
	ØD	20	25-40
	Screw (insert)	I60M3.5x6.5 (2.7 Nm)	I60M4x8.4 (3.4 Nm)
	Wrench (insert)	WT10IP	WT15IP

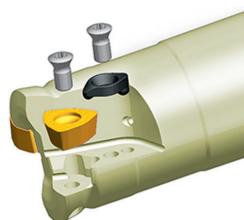



System code > B26

Grade selection > B24



Technical info > B527

Cutting data > B230

-  Ideal machining conditions
-  Normal machining conditions
-  Unfavourable machining conditions

WPGT	I.C	S	d
05 03	7.94	3.5	4
06 04	9.525	4.2	4.4

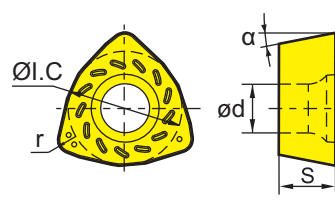
Milling inserts

WP** positive insert			HC ¹ (CVD)						HC ¹ (PVD)					HT	HC ²	HW									
		P																							
		M																							
		K																							
		N																							
		S																							
		H																							
ISO		r	YBC302	YBC301	YBC401	YBM253	YBM251	YBM351	YBD152	YBD252	YBG101	YBG102	YBG202	YBG212	YBS203	YBG205	YB9320	YBG302	YBS303	YBG252	YNG151	YNG151C	YD101	YD201	
	WPGT050315ZSR-PM	1.5																							
	WPGT060415ZSR-PM	1.5																							
	WPGT050315ZSR	1.5																							
	WPGT060415ZSR	1.5																							

● Ex stock ○ On demand

HC¹ Coated carbide
 HT Uncoated cermet
 HC² Coated cermet
 HW Uncoated carbide

A

Turning

B

Milling

C

Drilling

D

Technical Information

E

Index



High feed milling

XMR01 Kr: 11°-22°

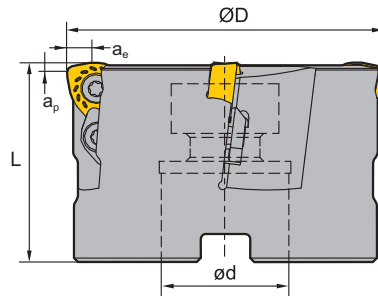
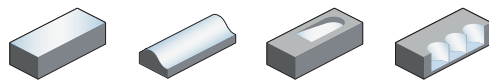

W type insert, Arbor mounting

Article	*	Stock	Dimensions [mm]					Teeth	Coupling	kg	Inserts
			ØD	ød	ap	ae	L				
XMR01-050-A22-WP06-04		●	50	22	1.5	4.35	50	4	A	0.4	WPGT0604
XMR01-050-A22-WP06-04C	*	●	50	22	1.5	4.35	50	4	A	0.4	
XMR01-050-A22-WP08-03		○	50	22	1.5	5.66	50	3	A	0.4	WPGT0806
XMR01-063-A27-WP08-04		●	63	27	1.5	5.66	50	4	A	0.7	
XMR01-063-A22-WP08-04C	*	●	63	22	1.5	5.66	50	4	A	0.7	
XMR01-063-A27-WP08-04C	*	○	63	27	1.5	5.66	50	4	A	0.7	
XMR01-080-A27-WP08-05C	*	●	80	27	1.5	5.66	63	5	A	1.5	
XMR01-100-B32-WP08-06		●	100	32	1.5	5.66	63	6	B	2.2	
XMR01-125-B40-WP08-07		●	125	40	1.5	5.66	63	7	B	3.5	WPGT0907
XMR01-160-B40-WP08-08		○	160	40	1.5	5.66	63	8	B	6	
XMR01-063-A22-WP09-03C	*	○	63	22	3	6.8	50	3	A	0.7	
XMR01-080-A27-WP09-04C	*	○	80	27	3	6.8	63	4	A	1.4	
XMR01-100-B32-WP09-05		○	100	32	3	6.8	63	5	B	2.1	WPGT0907
XMR01-125-B40-WP09-06		○	125	40	3	6.8	63	6	B	3.7	
XMR01-160-B40-WP09-07		○	160	40	3	6.8	63	7	B	6.3	

● Ex stock ○ On demand

* With internal cooling







Variable lead angle (lead angle ist hier dependent on size of inserts)
lead angle: WPGT05: 16°; WPGT06: 22°; WPGT08: 11°; WPGT09: 21°

System code > B26



Grade selection > B24

Technical info > B527



Cutting data > B230

Spare parts					
	Insert	WPGT0604	WPGT0806	WPGT0907	
	ØD	50	50-160	3-160	
	Clamp		WD-208	WD-208	
	Screw (clamp)		I60M5×13 (6.7 Nm)	I60M5×13 (6.7 Nm)	
	Screw (insert)	I60M4×8.4 (3.4 Nm)	I60M5×13 (6.7 Nm)	I60M5×13 (6.7 Nm)	
	Wrench (clamp)		WT20IT	WT20IT	
	Wrench (insert)	WT15IS			
	Wrench (insert)		WT20IT	WT20IT	

Milling inserts

-  Ideal machining conditions
-  Normal machining conditions
-  Unfavourable machining conditions

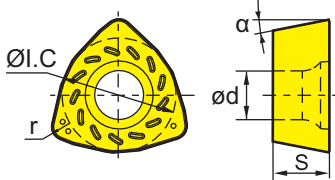
WPGT	I.C	S	d
06 04	9.525	4.2	4.4
08 06	12.85	6.35	5.5
09 07	15	7	5.5

WP** positive insert		HC ¹ (CVD)						HC ¹ (PVD)				HT	HC ²	HW											
	P																								
	M																								
	K																								
	N																								
	S																								
	H																								
ISO	r	YBC302	YBC301	YBC401	YBM253	YBM251	YBM351	YBD152	YBD252	YBG101	YBG102	YBG202	YBG212	YBS203	YBG205	YB9320	YBG302	YBS303	YBG252	YNG151		YNG151C	YD101	YD201	
	WPGT060415ZSR-PM	1.5	●											●	●			●							
	WPGT080615ZSR-PM	1.5	●											●	●			●							
	WPGT090725ZSR-PM	2.5													●										
	WPGT060415ZSR	1.5	●			●								●	●										
	WPGT080615ZSR	1.5	●			●								●	●										
	WPGT090725ZSR	2.5				●							○	●											

● Ex stock ○ On demand

HC¹ Coated carbide
 HT Uncoated cermet
 HC² Coated cermet
 HW Uncoated carbide

Bore milling

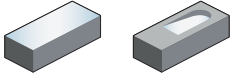

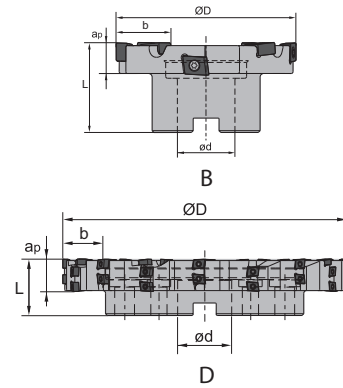
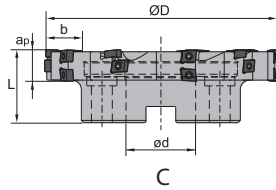
XMP01 Kr: 90° 



Article	* Stock	Dimensions [mm]					Teeth	Coupling	kg	Inserts 
		ØD	ød	b	ap	L				
XMP01-080*18-B27-CNE1210-08	●	80	27	18	15	50	8	B	0.67	CNE12
XMP01-100*18-B32-CNE1210-08	●	100	32	18	20	50	8	B	0.99	
XMP01-125*27-B40-CNE1210-15	●	125	40	27	22.5	63	15	B	2.46	
XMP01-160*27-C40-CNE1210-18	●	160	40	27	25	63	18	C	3.7	
XMP01-200*27-C60-CNE1210-21	●	200	60	27	31.5	63	21	C	5.46	
XMP01-250*36-C60-CNE1210-32	●	250	40	36	56.5	63	32	C	9.79	
XMP01-315*36-D60-CNE1210-42	●	315	60	36	47.5	63	42	D	17.65	
XMP01-400*36-D60-CNE1210-52	●	400	60	36	36	63	52	D	27.36	

● Ex stock ○ On demand

* With internal cooling

Spare parts		
	Insert ØD	CNE12 80-400
	Screw (insert)	I60M4x12 (3.4Nm)
	Wrench (insert)	WT15IP

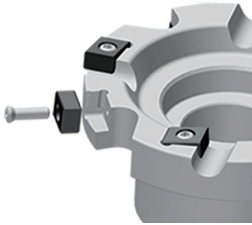

System code > B26

Grade selection > B24

Technical info > B527

Cutting data > B230

A

Turning

B

Milling

C

Drilling

D

Technical Information

E

Index

A

Turning

- Ideal machining conditions
- ⊗ Normal machining conditions
- ⊗ Unfavourable machining conditions

CNE	L	S	d
12	12.8	6.35	4.4

Milling inserts

CN** milling insert		HC ¹ (CVD)						HC ¹ (PVD)						HT	HC ²	HW
	P	⊗	⊗	⊗	⊗	⊗	⊗	⊗	⊗	⊗	⊗	⊗	⊗	⊗	⊗	
	M	⊗	⊗	⊗	⊗	⊗	⊗	⊗	⊗	⊗	⊗	⊗	⊗	⊗	⊗	
	K															⊗
	N															⊗
	S															
	H															

B

Milling

ISO		R/C	W	YBC302	YBC301	YBC401	YBM253	YBM251	YBM351	YBD152	YBD252	YBG101	YBG102	YBG202	YBG212	YBS203	YBG205	YB9320	YBG302	YBS303	YBG252	YNG151	YNG151C	YD101	YD201
	CNE121006A	0.4	10				●																		
	CNE121006B	0.6	10				○			●															

● Ex stock ○ On demand

HC¹ Coated carbide
 HT Uncoated cermet
 HC² Coated cermet
 HW Uncoated carbide

C

Drilling

D

Technical Information

E

Index

System code > B26

Grade selection > B24

Technical info > B527

Cutting data > B230

T-slot milling

TMP01 Kr: 90°

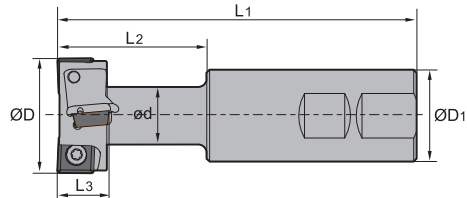
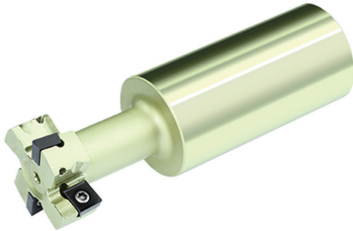
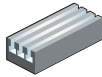





Weldon shank

Article	* Stock	Dimensions [mm]						Teeth	No. of inserts	T-slot specification	Inserts 
		ØD	ØD ₁	ød	L ₁	L ₂	L ₃				
TMP01-021-XP25-MP06-01	●	21	25	10	100	32	9	1	2	12	MPHT0603
TMP01-025-XP25-MP06-01	●	25	25	12	100	35	11	1	2	14	
TMP01-032-XP32-MP08-02	●	32	32	15	110	45	14	2	4	18	MPHT0803
TMP01-040-XP32-MP12-02C	* ●	40	32	19	125	55	18	2	4	22	MPHT1204
TMP01-050-XP40-MP12-02C	* ●	50	40	25	140	65	22	2	4	28	
TMP01-060-XP50-MP12-02	●	60	50	32	160	80	28	2	6	36	

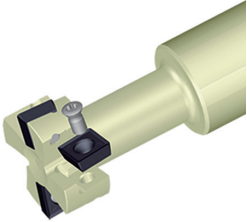
● Ex stock ○ On demand

* With internal cooling

Spare parts		MPHT0603	MPHT0803	MPHT1204	
Insert	ØD	21-25	32	40-60	
 Screw (insert)		I60M2.5x5.5 (1.0 Nm)	I60M3x7 (1.8 Nm)	I60M5x10 (6.7 Nm)	
 Wrench (insert)		WT07IP	WT09IP		
 Wrench (insert)				WT20IT	

System code > B26

Grade selection > B24

Technical info > B527

Cutting data > B230

A

Turning

B

Milling

C



Drilling

D

Technical Information



E

Index

-  Ideal machining conditions
-  Normal machining conditions
-  Unfavourable machining conditions

MPHT	L	I.C	S	d
06 03	6.35	6.35	3.18	2.8
08 03	8.3	8.3	3.18	3.4
12 04	12.7	12.7	4.76	5.56

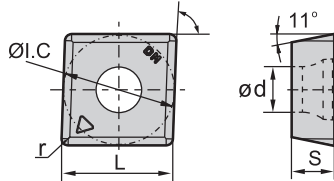
Milling inserts

MP** milling insert			HC ¹ (CVD)						HC ¹ (PVD)						HT	HC ²	HW							
	P																							
	M																							
	K																							
	N																							
	S																							
	H																							
	ISO	r	YBC302	YBC301	YBC401	YBM253	YBM251	YBM351	YBD152	YBD252	YBG101	YBG102	YBG202	YBG212	YBS203	YBG205	YB9320	YBG302	YBS303	YBG252	YNG151	YNG151C	YD101	YD201
	MPHT060304-DM	0.4	●			●												●						
	MPHT080305-DM	0.5	●			○												●						
	MPHT120408-DM	0.8	●			○		●										●						

● Ex stock ○ On demand

HC¹ Coated carbide
 HT Uncoated cermet
 HC² Coated cermet
 HW Uncoated carbide

Helical milling

HMP01 Kr: 90° 

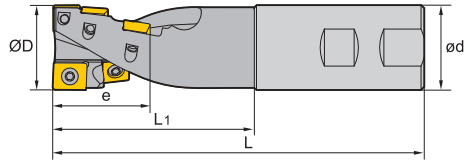



Weldon shank

Article	* Stock	Dimensions [mm]						Teeth row	Teeth		Shanktype	Inserts 
		ØD	e	ød	L ₁	L	APKT		SPMT			
HMP01-040x55-XP40-SP12-02	●	40	55	40	95	175	2	1	5	Weldon	APKT1504 & SPMT1204	
HMP01-050x55-XP40-SP12-04	●	50	55	40	95	175	4	2	10	Weldon		

● Ex stock ○ On demand

* With internal cooling

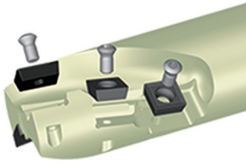
Spare parts

Insert		APKT1504 & SPMT1204	APKT1504 & SPMT1204	
ØD		40	50	
 Screw (insert)		I60M5×10 (6.7 Nm)	I60M5×13 (6.7 Nm)	
 Wrench (insert)		WT20T	WT20T	

System code > B26

Grade selection > B24

Technical info > B527

Cutting data > B230

A

Turning

B

Milling

C

Drilling

D

Technical Information

E

Index

- Ideal machining conditions
- ⊗ Normal machining conditions
- ⊗ Unfavourable machining conditions

APKT	L	S	d
15 04	16.33	4.76	5.4

Milling inserts

AP** milling insert		HC ¹ (CVD)						HC ¹ (PVD)					HT	HC ²	HW										
	P	⊗	⊗	⊗	⊗	⊗	⊗	⊗	⊗	⊗	⊗	⊗	⊗	⊗											
	M	⊗	⊗	⊗	⊗	⊗	⊗	⊗	⊗	⊗	⊗	⊗	⊗	⊗											
	K																								
	N																								
	S																								
	H																								
ISO		r	I.W	YBC302	YBC301	YBC401	YBM253	YBM251	YBM351	YBD152	YBD252	YBG101	YBG102	YBG202	YBG212	YBS203	YBG205	YB9320	YBG302	YBS303	YBG252	YNG151	YNG151C	YD101	YD201
	APKT150412-PM	1.2	12.7				●												●						

● Ex stock ○ On demand

HC¹ Coated carbide
 HT Uncoated cermet
 HC² Coated cermet
 HW Uncoated carbide

- Ideal machining conditions
- ⊗ Normal machining conditions
- ⊗ Unfavourable machining conditions

SPMT	L	I.C	S	d
12 04	12.7	12.7	4.76	5.5

Milling inserts

SP** milling insert		HC ¹ (CVD)						HC ¹ (PVD)					HT	HC ²	HW									
	P	⊗	⊗	⊗	⊗	⊗	⊗	⊗	⊗	⊗	⊗	⊗	⊗	⊗										
	M	⊗	⊗	⊗	⊗	⊗	⊗	⊗	⊗	⊗	⊗	⊗	⊗	⊗										
	K																							
	N																							
	S																							
	H																							
ISO		r	YBC302	YBC301	YBC401	YBM253	YBM251	YBM351	YBD152	YBD252	YBG101	YBG102	YBG202	YBG212	YBS203	YBG205	YB9320	YBG302	YBS303	YBG252	YNG151	YNG151C	YD101	YD201
	SPMT120408-PM	0.8				●												●						

● Ex stock ○ On demand

HC¹ Coated carbide
 HT Uncoated cermet
 HC² Coated cermet
 HW Uncoated carbide

System code > B26

Grade selection > B24

Technical info > B527

Cutting data > B230

Helical milling

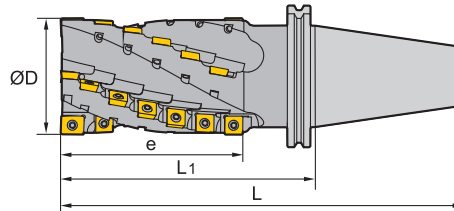
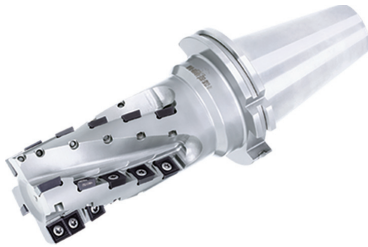

HMP01 Kr: 90° 



Article	* Stock	Dimensions [mm]				Teeth row	Teeth		Shanktype	Inserts 
		ØD	e	L ₁	L		APKT	SPMT		
HMP01-050x84-BT50-SP12-04	○	50	84	145	246.8	4	2	16	BT	APKT1504 & SPMT1204
HMP01-050x84-JT50-SP12-04	○	50	84	145	246.75	4	2	16	JT	
HMP01-063x74-BT50-SP12-04	○	63	74	135	236.8	4	2	14	BT	
HMP01-063x74-JT50-SP12-04	○	63	74	135	236.75	4	2	14	JT	
HMP01-063x104-BT50-SP12-04	○	63	104	165	266.8	4	2	20	BT	
HMP01-063x104-JT50-SP12-04	●	63	104	165	266.75	4	2	20	JT	
HMP01-063x134-BT50-SP12-04	○	63	134	195	296.8	4	2	26	BT	
HMP01-063x134-JT50-SP12-04	○	63	134	195	296.75	4	2	26	JT	
HMP01-080x104-BT50-SP12-04	○	80	104	165	266.8	4	2	20	BT	
HMP01-080x104-JT50-SP12-04	○	80	104	165	266.75	4	2	20	JT	
HMP01-080x144-BT50-SP12-04	○	80	144	205	306.8	4	2	28	BT	
HMP01-080x144-JT50-SP12-04	○	80	144	205	306.75	4	2	28	JT	

● Ex stock ○ On demand

* With internal cooling

Spare parts		
Insert	APKT1504 & SPMT1204	
ØD	50-80	
 Screw (insert)	I60M5x10 (6.7 Nm)	
 Wrench (insert)	WT20IS	



System code > B26

Grade selection > B24

Technical info > B527

Cutting data > B230

A

Turning

B

Milling

C

Drilling

D

Technical Information

E

Index

A

Turning

B

Milling

C

Drilling

D

Technical Information

E

Index

- Ideal machining conditions
- ⊗ Normal machining conditions
- ⊗ Unfavourable machining conditions

APKT	L	S	d
15 04	16.33	4.76	5.4

Milling inserts

AP** milling insert		HC ¹ (CVD)						HC ¹ (PVD)					HT	HC ²	HW										
	P	⊗	⊗	⊗	⊗	⊗	⊗	⊗	⊗	⊗	⊗	⊗	⊗	⊗											
	M	⊗	⊗	⊗	⊗	⊗	⊗	⊗	⊗	⊗	⊗	⊗	⊗	⊗											
	K								●							●									
	N									⊗						⊗									
	S			⊗	⊗					⊗	⊗	⊗	⊗	⊗											
	H																								
ISO		r	I.W	YBC302	YBC301	YBC401	YBM253	YBM251	YBM351	YBD152	YBD252	YBG101	YBG102	YBG202	YBG212	YBS203	YBG205	YB9320	YBG302	YBS303	YBG252	YNG151	YNG151C	YD101	YD201
	APKT150412-PM	1.2	12.7				●												●						

● Ex stock ○ On demand

HC¹ Coated carbide
 HT Uncoated cermet
 HC² Coated cermet
 HW Uncoated carbide

- Ideal machining conditions
- ⊗ Normal machining conditions
- ⊗ Unfavourable machining conditions

SPMT	L	I.C	S	d
12 04	12.7	12.7	4.76	5.5

Milling inserts

SP** milling insert		HC ¹ (CVD)						HC ¹ (PVD)					HT	HC ²	HW									
	P	⊗	⊗	⊗	⊗	⊗	⊗	⊗	⊗	⊗	⊗	⊗	⊗	⊗										
	M	⊗	⊗	⊗	⊗	⊗	⊗	⊗	⊗	⊗	⊗	⊗	⊗	⊗										
	K								●							●								
	N									⊗						⊗								
	S			⊗	⊗					⊗	⊗	⊗	⊗	⊗										
	H																							
ISO		r	YBC302	YBC301	YBC401	YBM253	YBM251	YBM351	YBD152	YBD252	YBG101	YBG102	YBG202	YBG212	YBS203	YBG205	YB9320	YBG302	YBS303	YBG252	YNG151	YNG151C	YD101	YD201
	SPMT120408-PM	0.8				●												●						

● Ex stock ○ On demand

HC¹ Coated carbide
 HT Uncoated cermet
 HC² Coated cermet
 HW Uncoated carbide

System code > B26

Grade selection > B24

Technical info > B527

Cutting data > B230

Helical milling



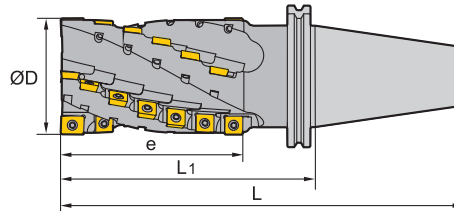
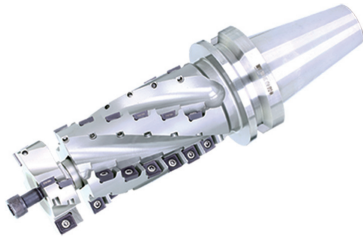

HMP01 EC Kr: 90° 



Article	* Stock	Dimensions [mm]				Teeth row	Teeth		Shanktype	Inserts 
		ØD	e	L ₁	L		APKT	SPMT		
HMP01-050x84EC-BT50-SP12-04	○	50	84	145	246.8	4	2	16	BT	APKT1504 & SPMT1204
HMP01-050x84EC-JT50-SP12-04	●	50	84	145	246.75	4	2	16	JT	
HMP01-063x74EC-BT50-SP12-04	○	63	74	135	236.8	4	2	14	BT	
HMP01-063x74EC-JT50-SP12-04	○	63	74	135	236.75	4	2	14	JT	
HMP01-063x104EC-BT50-SP12-04	○	63	104	165	266.8	4	2	20	BT	
HMP01-063x104EC-JT50-SP12-04	○	63	104	165	266.75	4	2	20	JT	
HMP01-063x134EC-BT50-SP12-04	○	63	134	195	296.8	4	2	26	BT	
HMP01-063x134EC-JT50-SP12-04	●	63	134	195	296.75	4	2	26	JT	
HMP01-080x104EC-BT50-SP12-04	○	80	104	165	266.8	4	2	20	BT	
HMP01-080x104EC-JT50-SP12-04	○	80	104	165	266.75	4	2	20	JT	
HMP01-080x144EC-BT50-SP12-04	○	80	144	205	306.8	4	2	28	BT	
HMP01-080x144EC-JT50-SP12-04	○	80	144	205	306.75	4	2	28	JT	

● Ex stock ○ On demand

* With internal cooling

Spare parts		APKT1504 & SPMT1204	APKT1504 & SPMT1204	APKT1504 & SPMT1204
Insert	ØD	50	63	80
 Indexable head		050EC	063EC	080EC
 Screw (head)		M10×50 (16.6 Nm)	M10×50 (16.6 Nm)	M12×55 (25.2 Nm)
 Screw (insert)		I60M5×13 (6.7 Nm)	I60M5×13 (6.7 Nm)	I60M5×13 (6.7 Nm)
 Wrench (head)		WH80L	WH80L	WH100L
 Wrench (insert)		WT20IS	WT20IS	WT20IS

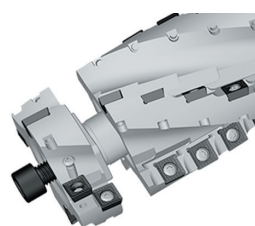

System code > B26

Grade selection > B24

Technical info > B527

Cutting data > B230

A

Turning

B

Milling

C

Drilling

D

Technical Information

E

Index

- Ideal machining conditions
- ⊗ Normal machining conditions
- ⊗ Unfavourable machining conditions

APKT	L	S	d
15 04	16.33	4.76	5.4

Milling inserts

AP** milling insert		HC ¹ (CVD)						HC ¹ (PVD)					HT	HC ²	HW									
	P	⊗	⊗	⊗	⊗	⊗	⊗	⊗	⊗	⊗	⊗	⊗	⊗	●	●	●								
	M	⊗	⊗	⊗	⊗	⊗	⊗	⊗	⊗	⊗	⊗	⊗	⊗	●	●	●								
	K							⊗	⊗					●		⊗								
	N							⊗								⊗								
	S		⊗	⊗				⊗	⊗	⊗	⊗	⊗	⊗											
	H																							
ISO	r	I.W	YBC302	YBC301	YBC401	YBM253	YBM251	YBM351	YBD152	YBD252	YBG101	YBG102	YBG202	YBG212	YBS203	YBG205	YB9320	YBG302	YBS303	YBG252	YNG151	YNG151C	YD101	YD201
	APKT150412-PM	1.2	12.7				●											●						

● Ex stock ○ On demand

HC¹ Coated carbide
 HT Uncoated cermet
 HC² Coated cermet
 HW Uncoated carbide

- Ideal machining conditions
- ⊗ Normal machining conditions
- ⊗ Unfavourable machining conditions

SPMT	L	I.C	S	d
12 04	12.7	12.7	4.76	5.5

Milling inserts

SP** milling insert		HC ¹ (CVD)						HC ¹ (PVD)					HT	HC ²	HW								
	P	⊗	⊗	⊗	⊗	⊗	⊗	⊗	⊗	⊗	⊗	⊗	⊗	●	●	●							
	M	⊗	⊗	⊗	⊗	⊗	⊗	⊗	⊗	⊗	⊗	⊗	⊗	●	●	●							
	K							⊗	⊗					●		⊗							
	N							⊗								⊗							
	S		⊗	⊗				⊗	⊗	⊗	⊗	⊗	⊗										
	H																						
ISO	r	YBC302	YBC301	YBC401	YBM253	YBM251	YBM351	YBD152	YBD252	YBG101	YBG102	YBG202	YBG212	YBS203	YBG205	YB9320	YBG302	YBS303	YBG252	YNG151	YNG151C	YD101	YD201
	SPMT120408-PM	0.8					●										●						

● Ex stock ○ On demand

HC¹ Coated carbide
 HT Uncoated cermet
 HC² Coated cermet
 HW Uncoated carbide

System code > B26

Grade selection > B24

Technical info > B527

Cutting data > B230

Chamfer milling

CMZ01 Kr: 30° 

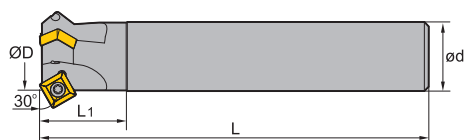



Straight shank

Article	*	Stock	Dimensions [mm]				Teeth	kg	Inserts
			ØD	ød	L ₁	L			
CMZ01-012-G20-SP12-01		●	12	20	40	100	1	0.2	 SPMT1204
CMZ01-025-G25-SP12-02		●	25	25	40	120	2	0.8	
CMZ01-032-G32-SP12-03		●	32	32	40	180	3	1.1	

● Ex stock ○ On demand

* With internal cooling

Spare parts		
	Insert ØD	SPMT1204 12-32
	Screw (insert)	M3M5×11 (6.7Nm)
	Wrench (insert)	WT20IS

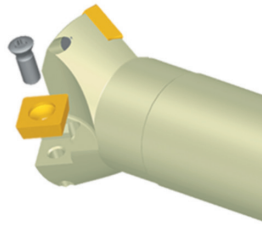

A

Turning

B

Milling

C

Drilling

D

Technical
Information

E

Index

A

Turning

B

Milling

C

Drilling

D

Technical Information

E

Index

- Ideal machining conditions
- ✳ Normal machining conditions
- ✳ Unfavourable machining conditions

SPMT	L	I.C	S	d
12 04	12.7	12.7	4.76	5.5

Milling inserts

SP** milling insert		HC ¹ (CVD)						HC ¹ (PVD)						HT	HC ²	HW									
	P	●	●	●	●	●	●	●	●	●	●	●	●	●											
	M	●	●	●	●	●	●	●	●	●	●	●	●	●											
	K							●						●		●									
	N							●							●	●									
	S		●	●				●	●	●	●	●	●												
	H																								
	ISO	r	YBC302	YBC301	YBC401	YBM253	YBM251	YBM351	YBD152	YBD252	YBG101	YBG102	YBG202	YBG212	YBS203	YBG205	YB9320	YBG302	YBS303	YBG252	YNG151	YNG151C	YD101	YD201	
	SPMT120408-HT-1	0.8												○											
	SPMT120408	0.8	○	●	○		●	○										○							

● Ex stock ○ On demand

HC¹ Coated carbide
 HT Uncoated cermet
 HC² Coated cermet
 HW Uncoated carbide



Chamfer milling

CMZ01 Kr: 30° 

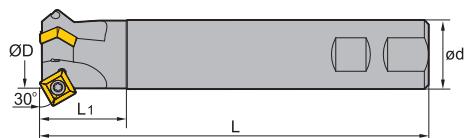



Weldon shank

Article	*	Stock	Dimensions [mm]				Teeth	kg	Inserts
			ØD	ød	L ₁	L			
CMZ01-025-XP25-SP12-02		●	25	25	40	120	2	0.6	 SPMT1204
CMZ01-032-XP32-SP12-03		●	32	32	40	180	3	1	
CMZ01-012-XP20-SP12-01		●	12	20	40	100	1	0.2	

● Ex stock ○ On demand

* With internal cooling

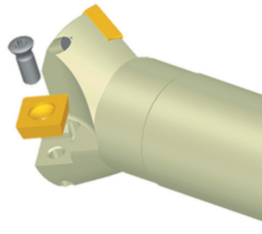
Spare parts

	Insert ØD	SPMT1204 12-32	
 Screw (insert)		I43M5×11 (6.7Nm)	
 Wrench (insert)		WT20IS	

A

Turning

B

Milling

C

Drilling

D

Technical
Information

E

Index

System code > B26

Grade selection > B24

Technical info > B527

Cutting data > B230

A

Turning

B

Milling

C

Drilling

D

Technical Information

E

Index

- Ideal machining conditions
- ✳ Normal machining conditions
- ✳ Unfavourable machining conditions

SPMT	L	I.C	S	d
12 04	12.7	12.7	4.76	5.5

Milling inserts

SP** milling insert		HC ¹ (CVD)						HC ¹ (PVD)						HT	HC ²	HW									
	P	●	●	●	●	●	●	●	●	●	●	●	●	●											
	M	✳	✳	✳	✳	✳	✳	✳	✳	✳	✳	✳	✳	✳											
	K							●						●		✳									
	N							●								✳	✳								
	S		✳	✳				●	●	●	●	●	●												
	H																								
	ISO	r	YBC302	YBC301	YBC401	YBM253	YBM251	YBM351	YBD152	YBD252	YBG101	YBG102	YBG202	YBG212	YBS203	YBG205	YB9320	YBG302	YBS303	YBG252	YNG151	YNG151C	YD101	YD201	
	SPMT120408-HT-1	0.8												○											
	SPMT120408	0.8	○	●	○		●	○										○							

● Ex stock ○ On demand

HC¹ Coated carbide
 HT Uncoated cermet
 HC² Coated cermet
 HW Uncoated carbide

Chamfer milling

CMA01 Kr: 45° 

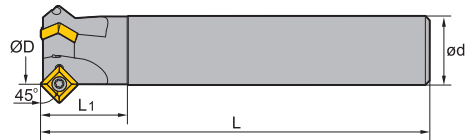



Straight shank

Article	*	Stock	Dimensions [mm]				Teeth	kg	Inserts
			ØD	ød	L ₁	L			
CMA01-012-G20-SP12-01		●	12	20	40	100	1	0.2	 SPMT1204
CMA01-025-G25-SP12-02		●	25	25	40	120	2	0.8	
CMA01-032-G32-SP12-03		●	32	32	40	180	3	1.1	

● Ex stock ○ On demand

* With internal cooling

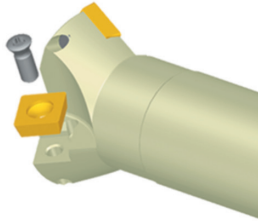
Spare parts

	Insert ØD	SPMT1204 12-32	
	Screw (insert)	M3M5x11 (6.7Nm)	
	Wrench (insert)	WT20IS	

A

Turning

B

Milling

C

Drilling

D

Technical
Information

E

Index

System code > B26

Grade selection > B24

Technical info > B527

Cutting data > B230

A

Turning

B

Milling

C

Drilling

D

Technical Information

E

Index

- Ideal machining conditions
- ● Normal machining conditions
- ● ● Unfavourable machining conditions

SPMT	L	I.C	S	d
12 04	12.7	12.7	4.76	5.5

Milling inserts

SP** milling insert		HC ¹ (CVD)						HC ¹ (PVD)						HT	HC ²	HW									
	P	●	●	●	●	●	●	●	●	●	●	●	●	●	●										
	M	●	●	●	●	●		●	●	●	●	●	●	●											
	K						●	●								●									
	N						●								●	●									
	S		●	●				●	●	●	●	●													
	H																								
	ISO	r	YBC302	YBC301	YBC401	YBM253	YBM251	YBM351	YBD152	YBD252	YBG101	YBG102	YBG202	YBG212	YBS203	YBG205	YB9320	YBG302	YBS303	YBG252	YNG151		YNG151C	YD101	YD201
	SPMT120408-HT-1	0.8											○												
	SPMT120408	0.8	○	●	○		●	○										○							

● Ex stock ○ On demand

HC¹ Coated carbide
 HT Uncoated cermet
 HC² Coated cermet
 HW Uncoated carbide

System code > B26

Grade selection > B24

Technical info > B527

Cutting data > B230

Chamfer milling

CMA01 Kr: 45° 

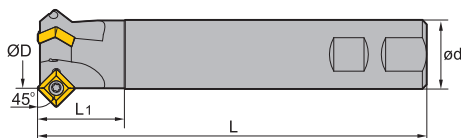



Weldon shank

Article	*	Stock	Dimensions [mm]				Teeth	kg	Inserts
			ØD	ød	L ₁	L			
CMA01-012-XP20-SP12-01		●	12	20	40	100	1	0.2	 SPMT1204
CMA01-025-XP25-SP12-02		●	25	25	40	120	2	0.6	
CMA01-032-XP32-SP12-03		●	32	32	40	100	3	1	

● Ex stock ○ On demand

* With internal cooling

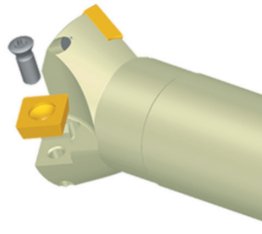
Spare parts

	Insert ØD	SPMT1204 12-32	
	Screw (insert)	M3M5x11 (6.7Nm)	
	Wrench (insert)	WT20IS	

A

Turning

B

Milling

C

Drilling

D

Technical
Information

E

Index

A

Turning

B

Milling

C

Drilling

D

Technical Information

E

Index

- Ideal machining conditions
- Normal machining conditions
- Unfavourable machining conditions

SPMT	L	I.C	S	d
12 04	12.7	12.7	4.76	5.5

Milling inserts

SP** milling insert		HC ¹ (CVD)						HC ¹ (PVD)						HT	HC ²	HW								
	P																							
	M																							
	K																							
	N																							
	S																							
	H																							
ISO		r	YBC302	YBC301	YBC401	YBM253	YBM251	YBM351	YBD152	YBD252	YBG101	YBG102	YBG202	YBG212	YBS203	YBG205	YB9320	YBG302	YBS303	YBG252	YNG151	YNG151C	YD101	YD201
	SPMT120408-HT-1	0.8												○										
	SPMT120408	0.8	○	●	○		●	○										○						

● Ex stock ○ On demand

HC¹ Coated carbide
 HT Uncoated cermet
 HC² Coated cermet
 HW Uncoated carbide



Chamfer milling

CMD01 Kr: 60° 

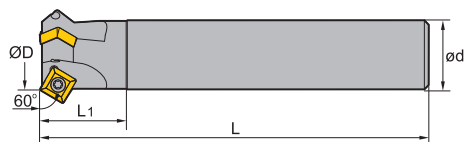



Straight shank

Article	*	Stock	Dimensions [mm]				Teeth	kg	Inserts
			ØD	ød	L ₁	L			
CMD01-012-G20-SP12-01		●	12	20	40	100	1	0.2	 SPMT1204
CMD01-025-G25-SP12-02		●	25	25	40	120	2	0.8	
CMD01-036-G32-SP12-03		●	36	32	40	180	3	1	

● Ex stock ○ On demand

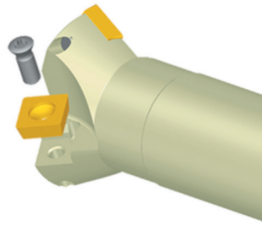
* With internal cooling

Spare parts			
	Insert	SPMT1204	
	ØD	12-36	
	Screw (insert)	I43M5×11 (6.7Nm)	
	Wrench (insert)	WT20IS	

A

Turning

B

Milling

C

Drilling

D

Technical
Information

E

Index

System code > B26

Grade selection > B24

Technical info > B527

Cutting data > B230

A

Turning

B

Milling

C

Drilling

D

Technical Information

E

Index

- Ideal machining conditions
- Normal machining conditions
- Unfavourable machining conditions

SPMT	L	I.C	S	d
12 04	12.7	12.7	4.76	5.5

Milling inserts

SP** milling insert		HC ¹ (CVD)						HC ¹ (PVD)						HT	HC ²	HW								
	P	●	●	●	●	●	●	●	●	●	●	●	●	●	●									
	M	●	●	●	●	●	●	●	●	●	●	●	●	●	●									
	K							●								●								
	N							●								●								
	S		●	●				●	●	●	●	●	●											
	H																							
ISO		r	YBC302	YBC301	YBC401	YBM253	YBM251	YBM351	YBD152	YBD252	YBG101	YBG102	YBG202	YBG212	YBS203	YBG205	YB9320	YBG302	YBS303	YBG252	YNG151	YNG151C	YD101	YD201
	SPMT120408-HT-1	0.8												○										
	SPMT120408	0.8	○	●	○		●	○										○						

● Ex stock ○ On demand

HC¹ Coated carbide
 HT Uncoated cermet
 HC² Coated cermet
 HW Uncoated carbide

System code > B26

Grade selection > B24

Technical info > B527

Cutting data > B230

Chamfer milling

CMD01 Kr: 60° 

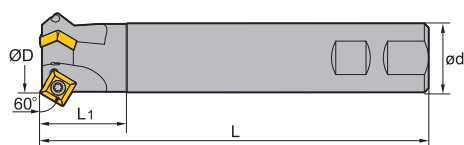



Weldon shank

Article	*	Stock	Dimensions [mm]				Teeth	kg	Inserts
			ØD	ød	L ₁	L			
CMD01-012-XP20-SP12-01		●	12	20	40	100	1	0.2	 SPMT1204
CMD01-025-XP25-SP12-02		●	25	25	40	120	2	0.6	
CMD01-036-XP32-SP12-03		●	36	32	40	180	3	1	

● Ex stock ○ On demand

* With internal cooling

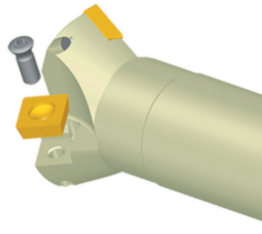
Spare parts

	Insert ØD	SPMT1204 12-36	
	Screw (insert)	M3M5x11 (6.7Nm)	
	Wrench (insert)	WT20IS	

A

Turning

B

Milling

C

Drilling

D

Technical
Information

E

Index

A

Turning

B

Milling

C

Drilling

D

Technical Information

E

Index

- Ideal machining conditions
- Normal machining conditions
- Unfavourable machining conditions

SPMT	L	I.C	S	d
12 04	12.7	12.7	4.76	5.5

Milling inserts

SP** milling insert		HC ¹ (CVD)						HC ¹ (PVD)						HT	HC ²	HW								
	P	●	●	●	●	●	●	●	●	●	●	●	●	●	●									
	M	●	●	●	●	●	●	●	●	●	●	●	●	●	●									
	K							●						●		●								
	N							●								●								
	S		●	●				●	●	●	●	●	●											
	H																							
ISO		r	YBC302	YBC301	YBC401	YBM253	YBM251	YBM351	YBD152	YBD252	YBG101	YBG102	YBG202	YBG212	YBS203	YBG205	YB9320	YBG302	YBS303	YBG252	YNG151	YNG151C	YD101	YD201
	SPMT120408-HT-1	0.8												○										
	SPMT120408	0.8	○	●	○		●	○										○						

● Ex stock ○ On demand

HC¹ Coated carbide
 HT Uncoated cermet
 HC² Coated cermet
 HW Uncoated carbide

Profile milling

QCH - XPHT

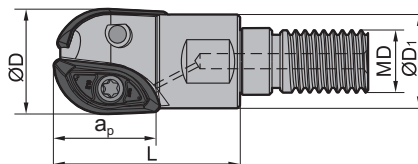
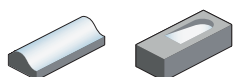

Article	*	Stock	Dimensions [mm]					Teeth	kg	Inserts
			ØD	ØD ₁	a _p	L	MD			
QCH-16-XPHT16-M10	●		16	17	16	28	10	2	0.036	XPHT16
QCH-20-XPHT20-M12	○		20	19	20	30	12	2	0.051	XPHT20
QCH-25-XPHT25-M12	●		25	24	25	35	12	2	0.071	XPHT25
QCH-30-XPHT30-M16	●		30	29	30	45	16	2	0.14	XPHT30
QCH-32-XPHT32-M16	●		32	30	32	45	16	2	0.162	XPHT32

● Ex stock ○ On demand

* With internal cooling

Spare parts							
Insert	XPHT16	XPHT20	XPHT25	XPHT30	XPHT32		
ØD	16	20	25	30	32		
Screw (insert)	I60M2.5×6.5 (1.0 Nm)		I60M4×10 (3.4 Nm)	I60M5×13.2 (6.7 Nm)	I60M5×13.2 (6.7 Nm)		
Screw (insert)		I60M3.5×8TT (2.7 Nm)					
Wrench (insert)		WT10IP					
Wrench (insert)				WT20IT	WT20IT		
Wrench (insert)	WT07P						
Wrench (insert)			WT15S				

A

Turning

B

Milling

C

Drilling



D

Technical Information











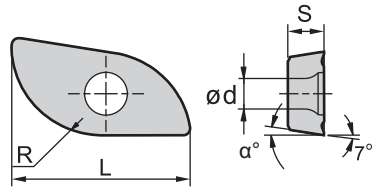























































E

Index

XPHT	L	S	d
16	16	3.18	3.1
20	20	3.97	4
25	25	4.76	4.7
30	30	6.35	5.8
32	32	6.35	5.8

-  Ideal machining conditions
-  Normal machining conditions
-  Unfavourable machining conditions

Milling inserts

XP** milling insert		HC ¹ (CVD)						HC ¹ (PVD)						HT	HC ²	HW									
		P																							
		M																							
		K																							
		N																							
		S																							
		H																							
ISO		R	α	YBC302	YBC301	YBC401	YBM253	YBM251	YBM351	YBD152	YBD252	YBG101	YBG102	YBG202	YBG212	YBS203	YBG205	YB9320	YBG302	YBS303	YBG252	YNG151	YNG151C	YD101	YD201
	XPHT16R0803-GM	8	9																						
	XPHT20R10T3-GM	10	9																						
	XPHT25R1204-GM	12.5	9																						
	XPHT30R1506-GM	15	11																						
	XPHT32R1606-GM	16	9																						

● Ex stock ○ On demand

HC¹ Coated carbide
 HT Uncoated cermet
 HC² Coated cermet
 HW Uncoated carbide



High-feed mills

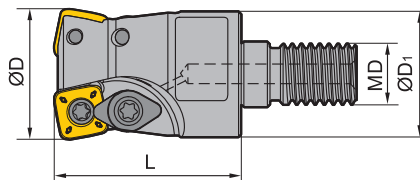
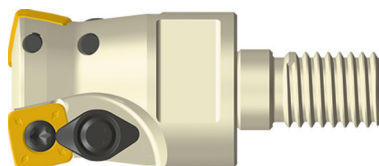
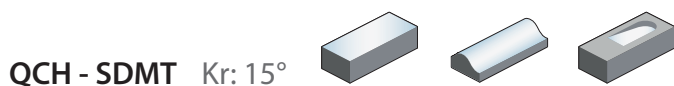

Article	*	Stock	Dimensions [mm]				Teeth	kg	Inserts
			ØD	ØD ₁	L	MD			
QCH-20-SDMT06-M10-03		●	20	19	30	10	3	0.058	SDMT06T2
QCH-25-SDMT06-M12-04		●	25	24	35	12	4	0.097	
QCH-32-SDMT06-M16-05		○	32	30	45	16	5	0.183	
QCH-25-SDMT09-M12-02		○	25	24	35	12	2	0.088	SDMT09T3
QCH-30-SDMT09-M16-03		●	30	29	45	16	3	0.176	
QCH-35-SDMT09-M16-03		○	35	30	45	16	3	0.216	
QCH-32-SDMT12-M16-02		●	32	30	45	16	2	0.175	SDMT1204
QCH-35-SDMT12-M16-02		○	35	30	45	16	2	0.2	
QCH-40-SDMT12-M16-03		○	40	30	45	16	3	0.3	

● Ex stock ○ On demand

*With internal cooling

Spare parts					
	Insert	SDMT06T2	SDMT09T3	SDMT1204	
	ØD	20-35	25-35	32-40	
	Clamp		WD-204	WD-204	
	Screw (clamp)			I60M4x8.4 (3.4 Nm)	
	Screw (clamp)		I60M3.5x08TT (2.7 Nm)		
	Screw (insert)	I60M2.2x5.5 (0.8 Nm)	I60M4x8.4 (3.4 Nm)	I60M4x8.4 (3.4 Nm)	
	Wrench (clamp)		WT10IP	WT15IP	
	Wrench (insert)	WT07IP	WT15IP	WT15IP	

System code > B26

Grade selection > B24

Technical info > B527

Cutting data > B230

A

Turning

B

Milling

C



Drilling

D

Technical Information



E

Index

-  Ideal machining conditions
-  Normal machining conditions
-  Unfavourable machining conditions

SDMT	L	I.C	S	d
06 T2	6.35	6.35	2.58	5.5
09 T3	9.525	9.525	3.97	4
12 04	12.7	12.7	4.76	4.4

Milling inserts

SD** milling insert			HC ¹ (CVD)						HC ¹ (PVD)						HT	HC ²	HW						
ISO	r	α	P	M	K	N	S	H	P	M	K	N	S	H									
			YBC302	YBC301	YBC401	YBM253	YBM251	YBM351	YBD152	YBD252	YBG101	YBG102	YBG202	YBG212	YBS203	YBG205	YB9320	YBG302	YBS303	YBG252	YNG151	YNG151C	YD101
	SDMT06T208-DM	0.8	15																				
	SDMT09T312-DM	1.2	15	●			●	○		○	○				●								
	SDMT120412-DM	1.2	15	●			●	●		○	○												
	SDMT09T312-NM				●						○	●			●								
	SDMT120412-NM				●						○	●	●		●								
	SDMT06T208-PM	0.8	15	●	●							○	●		○								
	SDMT09T312-PM	1.2	15		●			○		○			●										
	SDMT120412-PM	1.2	15		●					○			●										

● Ex stock ○ On demand

HC¹ Coated carbide
 HT Uncoated cermet
 HC² Coated cermet
 HW Uncoated carbide



High-feed mills

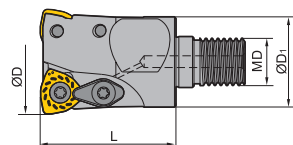
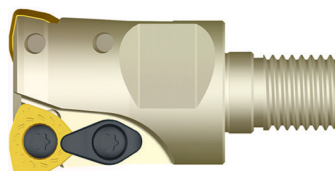
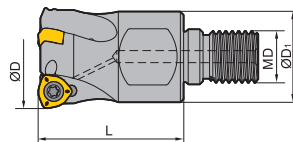
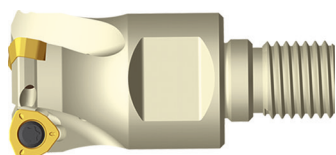
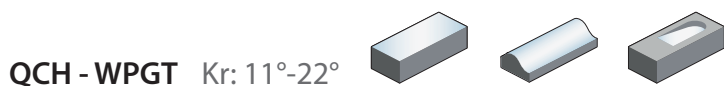

Article	*	Stock	Dimensions [mm]				Teeth	kg	Inserts
			ØD	ØD ₁	L	MD			
QCH-20-WPGT05-M10-02		○	20	18	30	10	2	0.056	WPGT0503
QCH-25-WPGT06-M12-02		○	25	21	35	12	2	0.097	WPGT0604
QCH-32-WPGT06-M16-03		●	32	29	43	16	3	0.185	
QCH-35-WPGT06-M16-03		●	35	30	45	16	3	0.201	
QCH-42-WPGT06-M16-04		○	42	29	43	16	4		
QCH-35-WPGT08-M16-02		●	35	30	45	16	2	0.196	WPGT0806

● Ex stock ○ On demand

* With internal cooling

Variable lead angle (lead angle ist hier dependent on size of inserts)
lead angle: WPGT05: 16°; WPGT06: 22°; WPGT08: 11°; WPGT09: 21°

Spare parts					
	Insert	WPGT0503	WPGT0604	WPGT0806	
	ØD	20	25-42	35	
	Clamp			WD-208	
	Screw (clamp)			I60M5×13 (6.7 Nm)	
	Screw (insert)		I60M4×8.4 (3.4 Nm)	I60M5×13 (6.7 Nm)	
	Screw (insert)	I60M3.5×08TT (2.7 Nm)			
	Wrench (clamp)			WT20IT	
	Wrench (insert)			WT20IT	
	Wrench (insert)	WT10P	WT15P		

A

Turning

B

Milling

C

Drilling

D

Technical Information

E

Index

WPGT	I.C	S	d
05 03	7.94	3.5	4
06 04	9.525	4.2	4.4
08 06	12.85	6.35	5.5

- Ideal machining conditions
- Normal machining conditions
- Unfavourable machining conditions

Milling inserts

WP** positive insert		HC ¹ (CVD)						HC ¹ (PVD)						HT	HC ²	HW									
	P	●	●	●	●	●	●	●	●	●	●	●	●	●											
	M	●	●	●	●	●	●	●	●	●	●	●	●	●											
	K							●								●									
	N							●							●	●									
	S		●	●				●	●	●	●	●	●												
	H																								
ISO		r	YBC302	YBC301	YBC401	YBM253	YBM251	YBM351	YBD152	YBD252	YBG101	YBG102	YBG202	YBG212	YBS203	YBG205	YB9320	YBG302	YBS303	YBG252	YNG151	YNG151C	YD101	YD201	
	WPGT050315ZSR-PM	1.5													●										
	WPGT060415ZSR-PM	1.5	●												●	●			●						
	WPGT080615ZSR-PM	1.5	●												●	●			●						
	WPGT050315ZSR	1.5	●				●						●												
	WPGT060415ZSR	1.5	●				●						●		●										
	WPGT080615ZSR	1.5	●				●						●		●										

● Ex stock ○ On demand

HC¹ Coated carbide
 HT Uncoated cermet
 HC² Coated cermet
 HW Uncoated carbide



QCH series

QCH - APKT Kr: 90°

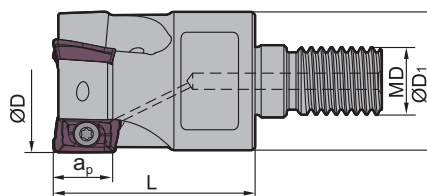
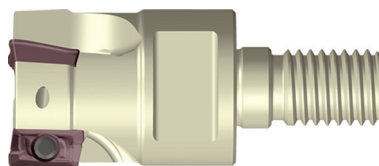
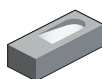

Article	*	Stock	Dimensions [mm]					Teeth	kg	Inserts
			ØD	ØD ₁	a _p	L	MD			
QCH-16-APKT11-M8-02	●		16	12.5	10.5	25	8	2	0.028	APKT11T3
QCH-20-APKT11-M10-03	●		20	18	10.5	30	10	3	0.059	
QCH-25-APKT11-M12-04	●		25	21	10.5	35	12	4	0.104	
QCH-32-APKT11-M16-05	●		32	29	10.5	43	16	5		
QCH-40-APKT11-M16-06	●		40	29	10.5	43	16	6		
QCH-25-APKT16-M12-02	○		25	21	10.5	38	12	2	0.09	
QCH-32-APKT16-M16-03	●		32	29	10.5	46	16	3		
QCH-40-APKT16-M16-04	○		40	29	10.5	46	16	4		

● Ex stock ○ On demand

* With internal cooling

Spare parts				
Insert	APKT11T3	APKT1604		
ØD	16-40	25-40		
Screw (insert)		I60M4x8,4 (3.4Nm)		
Screw (insert)	I60M2.5x6.5T (1.0Nm)			
Wrench (insert)	WT08IP	WT15IP		

A

Turning

B

Milling

C



Drilling

D

Technical Information







E

Index

-  Ideal machining conditions
-  Normal machining conditions
-  Unfavourable machining conditions

APKT	L	S	d
11 T3	12.24	3.6	2.8
16 04	17.877	5.76	4.4

Milling inserts



AP** milling insert				HC ¹ (CVD)						HC ¹ (PVD)					HT	HC ²	HW								
				P	M	K	N	S	H																
ISO	r	I.W		YBC302	YBC301	YBC401	YBM253	YBM251	YBM351	YBD152	YBD252	YBG101	YBG102	YBG202	YBG212	YBS203	YBG205	YB9320	YBG302	YBS303	YBG252	YNG151	YNG151C	YD101	YD201
	APKT11T304-ALH	0.4	6.5									●													● ●
	APKT11T308-ALH	0.8	6.5									●													● ●
	APKT160408-ALH	0.8	9.33									●													● ●
	APKT11T304-APF	0.4	6.5														●								
	APKT11T308-APF	0.8	6.5													○	●	○							
	APKT160408-APF	0.8	9.33													○	●	○	○						
	APKT11T304-APM	0.4	6.5				●		●									●							
	APKT11T308-APM	0.8	6.5				●		●							○	●	○							
	APKT11T312-APM	1.2	6.5				●		●									●							
	APKT11T316-APM	1.6	6.5				●		●									●							
	APKT11T320-APM	2	6.5				●		●									●							
	APKT160408-APM	0.8	9.33				●		● ●							○	●	○							
	APKT160416-APM	1.6	9.33				●		●									●							
	APKT160420-APM	2	9.33				●		●									●							
	APKT160424-APM	2.4	9.33				●		●									●							
	APKT160430-APM	3	9.33				●											●							
	APKT11T304-LH	0.4	6.5																						○ ○
	APKT11T308-LH	0.8	6.5																						○ ●
	APKT160408-LH	0.8	9.33																						○ ○
	APKT11T308-NM															●		●							
	APKT11T312-NM															●		●							
	APKT11T304-PF	0.4	6.5		○		○						○ ○						○						
	APKT11T308-PF	0.8	6.5											○											
	APKT11T316-PF	1.6	6.5											○											
	APKT160408-PF	0.8	9.33		○		○							○					○						
	APKT160430-PF	3	9.33		○																				
	APKT11T304-PM	0.4	6.5		○ ○ ○		○ ○						○ ○						○						
	APKT11T308-PM	0.8	6.5		○ ○ ○		○ ○ ● ○ ○						○ ○				○		○						
	APKT11T312-PM	1.2	6.5				○						○ ○						○						
	APKT11T316-PM	1.6	6.5				○						○ ○						○						
	APKT160408-PM	0.8	9.33		○ ○ ○ ●		● ○ ○						○ ○				○		●						
	APKT160416-PM	1.6	9.33		○								○												

● Ex stock ○ On demand



HC¹ Coated carbide
 HT Uncoated cermet
 HC² Coated cermet
 HW Uncoated carbide



Milling inserts

-  Ideal machining conditions
-  Normal machining conditions
-  Unfavourable machining conditions

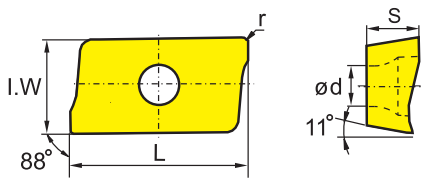
APKT	L	S	d
11 T3	12.24	3.6	2.8
16 04	17.877	5.76	4.4

AP** milling insert			HC ¹ (CVD)						HC ¹ (PVD)					HT	HC ²	HW										
			P	M	K	N	S	H																		
																										
ISO			r	I.W	YBC302	YBC301	YBC401	YBM253	YBM251	YBM351	YBD152	YBD252	YBG101	YBG102	YBG202	YBG212	YBS203	YBG205	YB9320	YBG302	YBS303	YBG252	YNG151	YNG151C	YD101	YD201
	APKT11T304-PR	0.4	6.5						○											○						
	APKT11T316-PR	1.6	6.5																	○						
	APKT11T3XR									●										●						

● Ex stock ○ On demand

HC¹ Coated carbide
 HT Uncoated cermet
 HC² Coated cermet
 HW Uncoated carbide

A

Turning

B

Milling

C

Drilling

D

Technical Information

E

Index

System code > B26

Grade selection > B24

Technical info > B527

Cutting data > B230



Indexable milling QCH series

QCH series

QCH - RD

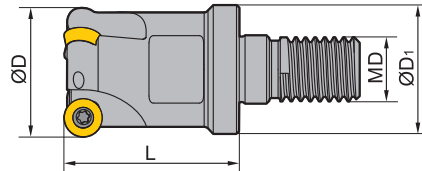
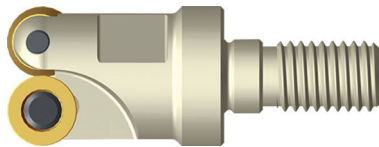
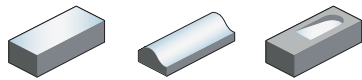

Article	*	Stock	Dimensions [mm]				Teeth	kg	Inserts
			ØD	ØD ₁	L	MD			
QCH-16-RD07-M8-02		●	16	15	25	8	2	0.027	
QCH-20-RD07-M10-03		○	20	18	30	10	3	0.058	RDKW0702
QCH-25-RD07-M12-03		○	25	21	35	12	3	0.093	
QCH-20-RD10-M10-02		○	20	19	30	10	2	0.054	
QCH-25-RD10-M12-02		○	25	24	35	12	2	0.097	RDKW10T3
QCH-32-RD10-M16-03		○	32	30	45	16	3	0.183	
QCH-32-RD16-M16-02		○	32	30	45	16	2	0.156	RDKW1605

● Ex stock ○ On demand

* With internal cooling

Spare parts



	Insert	RDKW0702	RDKW10T3	RDKW1605	
		ØD	16-25	20-32	
	Screw (insert)	I60M2.5×5.0 (1.0 Nm)	I60M4×8 (3.4 Nm)	I60M5×13 (6.7 Nm)	
	Wrench (insert)	WT08IP	WT15IP		
	Wrench (insert)			WT20IT	

System code > B26

Grade selection > B24











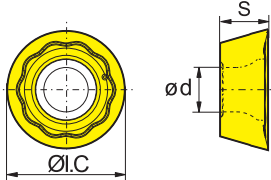































Technical info > B527

Cutting data > B230

-  Ideal machining conditions
-  Normal machining conditions
-  Unfavourable machining conditions



RDKT
10 T3

Milling inserts

RD** milling insert		HC ¹ (CVD)						HC ¹ (PVD)					HT	HC ²	HW									
	P																							
	M																							
	K																							
	N																							
	S																							
	H																							
ISO		YBC302	YBC301	YBC401	YBM253	YBM251	YBM351	YBD152	YBD252	YBG101	YBG102	YBG202	YBG212	YBS203	YBG205	YB9320	YBG302	YBS303	YBG252	YNG151		YNG151C	YD101	YD201
	RDKT10T3MO-MM																							











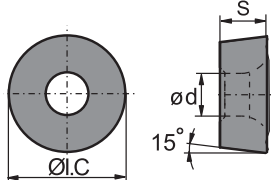































● Ex stock ○ On demand

HC¹ Coated carbide
HT Uncoated cermet
HC² Coated cermet
HW Uncoated carbide

-  Ideal machining conditions
-  Normal machining conditions
-  Unfavourable machining conditions

RDKW	I.C	S	d
07 02	7	2.38	2.7
10 T3	10	3.97	4.4
16 05	16	5.56	5.5

Milling inserts

RD** milling insert		HC ¹ (CVD)						HC ¹ (PVD)					HT	HC ²	HW									
	P																							
	M																							
	K																							
	N																							
	S																							
	H																							
ISO		YBC302	YBC301	YBC401	YBM253	YBM251	YBM351	YBD152	YBD252	YBG101	YBG102	YBG202	YBG212	YBS203	YBG205	YB9320	YBG302	YBS303	YBG252	YNG151		YNG151C	YD101	YD201
	RDKW10T3MO	●	○			○				●	○		○				○							
	RDKW1605MO					○						○	○				○							
	RDKW0702MO-1					●					○			●										
	RDKW0702MO-2									●														

● Ex stock ○ On demand

HC¹ Coated carbide
HT Uncoated cermet
HC² Coated cermet
HW Uncoated carbide

QCH series

QCH - RD

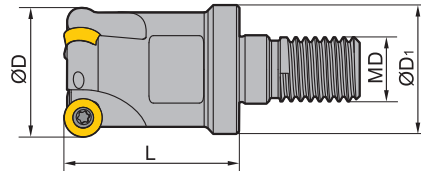
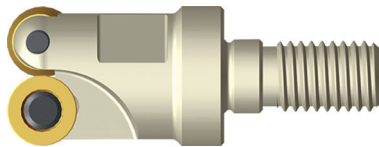

Article	*	Stock	Dimensions [mm]				Teeth		Inserts
			ØD	ØD ₁	L	MD			
QCH-15-RDKW0702-M8-02		●	15	12.5	23	8	2	RDKW0702	
QCH-15-RDKW0702-M8-03		●	15	12.5	23	8	3		
QCH-20-RDKW0702-M10-04		●	20	18	30	10	4		
QCH-25-RDKW0702-M12-05		●	25	21	35	12	5	RDKW1003	
QCH-20-RDKW1003-M10-02		●	20	18	30	10	2		
QCH-25-RDKW1003-M12-02		●	25	21	35	12	2		
QCH-25-RDKW1003-M12-03		●	25	21	35	12	3	RDKW1003	
QCH-30-RDKW1003-M16-04		●	30	29	43	16	4		
QCH-35-RDKW1003-M16-04		●	35	29	43	16	4		
QCH-42-RDKW1003-M16-05		●	42	29	43	16	5	RDKW12T3	
QCH-24-RDKW12T3-M12-02		●	24	21	35	12	2		
QCH-35-RDKW12T3-M16-03		●	35	29	43	16	3		
QCH-42-RDKW12T3-M16-04		●	42	29	43	16	4	RDKW1604	
QCH-32-RDKW1604-M16-02		●	32	29	43	16	2		

● Ex stock ○ On demand

* With internal cooling

Spare parts					
	Insert	RDKW0702	RDKW1003	RDKW12T3	RDKW1604
	ØD	15-25	20-42	24-42	32
	Clamp				WX16N
	Screw (clamp)				I60M4.5×10 (5.0 Nm)
	Screw (clamp)			LOM3.5×7.1	
	Screw (insert)	I60M2.5×5.0 (1.0 Nm)	I60M3.5×7.7 (2.7 Nm)	I60M3.5×7.7 (2.7 Nm)	I60M4.5×10 (5.0 Nm)
	Wrench (insert)	WT07P	WT15P	WT15P	
	Wrench (insert)				WT20T



System code > B26

Grade selection > B24











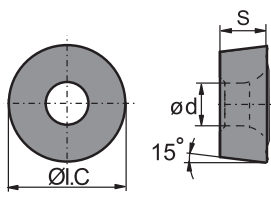































Technical info > B527

Cutting data > B230

RDKW	I.C	S	d
07 02	7	2.38	2.7
10 03	10	3.18	3.9
12 T3	12	3.97	3.9
16 04	16	4.76	5.2

-  Ideal machining conditions
-  Normal machining conditions
-  Unfavourable machining conditions

Milling inserts

RD** milling insert		HC ¹ (CVD)						HC ¹ (PVD)					HT	HC ²	HW										
		P																							
		M																							
		K																							
		N																							
		S																							
		H																							
ISO		YBC302	YBC301	YBC401	YBM253	YBM251	YBM351	YBD152	YBD252	YBG101	YBG102	YBG202	YBG212	YBS203	YBG205	YB9320	YBG302	YBS303	YBG252	YNG151		YNG151C	YD101	YD201	
	RDKW0702MO-1						●				○				●										
	RDKW0702MO-2									●															
	RDKW1003MO-1				○	●					○				●	●									
	RDKW1003MO-2									●															
	RDKW1003MO-3			●											●										
	RDKW12T3MO-1				○	●						○			●	●									
	RDKW12T3MO-2									●						○									
	RDKW12T3MO-3			●											●										
	RDKW1604MO-1					●						○			●	●	●								
	RDKW1604MO-2										○														
	RDKW1604MO-3		○		●				●		○				●		●								

● Ex stock ○ On demand

HC¹ Coated carbide
 HT Uncoated cermet
 HC² Coated cermet
 HW Uncoated carbide



QCH series

QCH - ZOHX

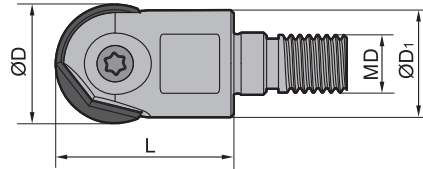
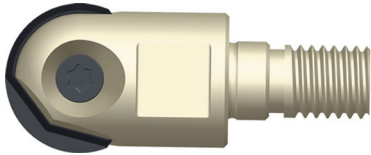
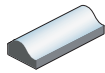

Article	*	Stock	Dimensions [mm]				kg	Inserts
			ØD	ØD ₁	L	MD		
QCH-16-ZOHX16-M8	●	●	16	15	28	8	0.029	ZOHX16
QCH-20-ZOHX20-M10	●	●	20	19	30	10	0.048	ZOHX20
QCH-25-ZOHX25-M12	●	●	25	24	35	12	0.087	ZOHX25
QCH-30-ZOHX30-M16	●	●	30	29	45	16	0.17	ZOHX30
QCH-32-ZOHX32-M16	●	●	32	30	45	16	0.18	ZOHX32

● Ex stock ○ On demand

* With internal cooling

Spare parts		ZOHX16	ZOHX20	ZOHX25	ZOHX30	ZOHX32	
Insert	ØD	16	20	25	30	32	
Screw (insert)		I70M5×12TT (6.7 Nm)	I70M5×16TT (6.7 Nm)	I70M6×20TT (9.1 Nm)	I70M8×25TT (16.2 Nm)	I70M8×25TT (16.2 Nm)	
Wrench (insert)		WT20IP	WT20IP	WT20IP			
Wrench (insert)					WT30IT	WT30IT	



System code > B26

Grade selection > B24



Technical info > B527

Cutting data > B230

ZO ¹⁶	I.C	S	d
16	16	4	5
20	20	5	5
25	25	6	6
30	30	7	8
32	32	7	8

-  Ideal machining conditions
-  Normal machining conditions
-  Unfavourable machining conditions

Milling inserts

ZO ^{**} milling insert		HC ¹ (CVD)						HC ¹ (PVD)					HT	HC ²	HW									
ISO		R	YBC302	YBC301	YBC401	YBM253	YBM251	YBM351	YBD152	YBD252	YBG101	YBG102	YBG202	YBG212	YBS203	YBG205	YB9320	YBG302	YBS303	YBG252	YNG151	YNG151C	YD101	YD201
	ZOHX1604-GF	8	●	●	●	●	●	●	●	●	●	●	●	●	●	●	●	●	●	●	●			
	ZOHX2005-GF	10																						
	ZOHX2506-GF	12.5																						
	ZOHX3007-GF	15																						
	ZOHX3207-GF	16																						
	ZOHX1604-GM	8																				●		
	ZOHX2005-GM	10																				●		
	ZOHX2506-GM	12.5																				○		
	ZOHX3007-GM	15																				●		
	ZOHX3207-GM	16																				●		

● Ex stock ○ On demand

HC¹ Coated carbide
 HT Uncoated cermet
 HC² Coated cermet
 HW Uncoated carbide

A

Turning

B

Milling

C

Drilling

D

Technical Information

E

Index



Indexable milling QCH series

QCH series

QCH-SDMT-Q

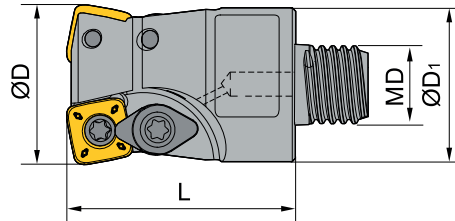
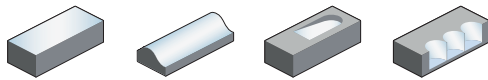

Article	*	Stock	Dimensions [mm]				Teeth	kg	Inserts
			ØD	ØD ₁	L	MD			
QCH-25-SDMT09-Q14-02	*	○	25	24	35	14	2	0.088	SDMT09T3
QCH-35-SDMT09-Q18-03	*	○	35	30	45	18	3	0.216	

● Ex stock ○ On demand

* With internal cooling

Spare parts		
	Insert	SDMT09T3
	ØD	25-35
	Clamp	WD-204
	Screw (clamp)	I60M4x8.4 (3.4 Nm)
	Screw (insert)	I60M3.5x08TT (2.7 Nm)
	Wrench (insert)	WT10IP

System code > B26

Grade selection > B24

Technical info > B527

Cutting data > B230

A

Turning

B

Milling

C

Drilling

D

Technical Information

E

Index

- Ideal machining conditions
- Normal machining conditions
- Unfavourable machining conditions

SDMT	L	I.C	S	d
09 T3	9.525	9.525	3.97	4

Milling inserts

SD** milling insert			HC ¹ (CVD)						HC ¹ (PVD)					HT	HC ²	HW										
			P	M	K	N	S	H																		
	ISO	r	α	YBC302	YBC301	YBC401	YBM253	YBM251	YBM351	YBD152	YBD252	YBG101	YBG102	YBG202	YBG212	YBS203	YBG205	YB9320	YBG302	YBS303	YBG252	YNG151	YNG151C	YD101	YD201	
	SDMT09T312-DM	1.2	15	●					●	○				○	○					●						
	SDMT09T312-NM					●									○	●					●					
	SDMT09T312-PM	1.2	15			●				○				○			●									

● Ex stock ○ On demand

HC¹ Coated carbide
 HT Uncoated cermet
 HC² Coated cermet
 HW Uncoated carbide

A

Turning

B

Milling

C

Drilling

D

Technical Information

E

Index

QCH series

QCH-APKT-Q Kr: 90°

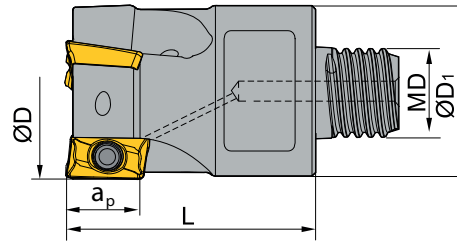
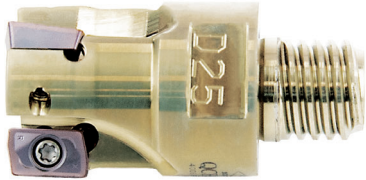
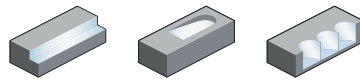



Article	*	Stock	Dimensions [mm]					Teeth	kg	Inserts
			ØD	ØD ₁	a _p	L	MD			
QCH-16-APKT11-Q10-02	*	●	16	15.2	10.5	28	10	2	0.028	 APKT11T3
QCH-20-APKT11-Q12-02	*	○	20	19	10.5	30	12	2	0.059	
QCH-25-APKT11-Q14-03	*	●	25	24	10.5	35	14	3	0.104	

● Ex stock ○ On demand

* With internal cooling

Spare parts

	Insert	APKT11T3
	ØD	16-25
	Screw (insert)	I60M2.5x5.5 (1.0Nm)
	Wrench (insert)	WT07IP

System code > B26

Grade selection > B24

Technical info > B527

Cutting data > B230

A

Turning

B

Milling

C

Drilling

D

Technical Information

E

Index

- Ideal machining conditions
- Normal machining conditions
- Unfavourable machining conditions

APKT	L	S	d
11 T3	12.24	3.6	2.8

Milling inserts

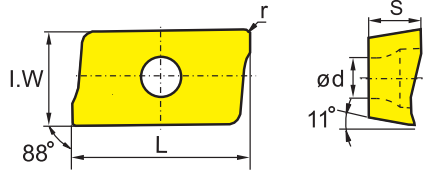

AP** milling insert			HC ¹ (CVD)						HC ¹ (PVD)					HT	HC ²	HW									
			P	M	K	N	S	H																	
ISO	r	I.W	YBC302	YBC301	YBC401	YBM253	YBM251	YBM351	YBD152	YBD252	YBG101	YBG102	YBG202	YBG212	YBS203	YBG205	YB9320	YBG302	YBS303	YBG252	YNG151	YNG151C	YD101	YD201	
APKT11T304-ALH	0.4	6.5									●													●	●
APKT11T308-ALH	0.8	6.5									●													●	●
APKT11T304-APF	0.4	6.5														●									
APKT11T308-APF	0.8	6.5												○		●		○							
APKT11T304-APM	0.4	6.5				●		●								●									
APKT11T308-APM	0.8	6.5				●		●						○		●		○							
APKT11T312-APM	1.2	6.5				●		●								●									
APKT11T316-APM	1.6	6.5				●		●								●									
APKT11T320-APM	2	6.5				●		●								●									
APKT11T304-LH	0.4	6.5																						○	○
APKT11T308-LH	0.8	6.5																						○	●
APKT11T308-NM															●				●						
APKT11T312-NM															●				●						
APKT11T304-PF	0.4	6.5	○		○							○	○					○							
APKT11T308-PF	0.8	6.5											○												
APKT11T316-PF	1.6	6.5											○												
APKT11T304-PM	0.4	6.5	○	○	○	○	○	○				○	○					○							
APKT11T308-PM	0.8	6.5	○	○		○	○	●	○	○		○	○			○		○							
APKT11T312-PM	1.2	6.5					○						○					○							
APKT11T316-PM	1.6	6.5					○						○					○							
APKT11T304-PR	0.4	6.5						○										○							
APKT11T316-PR	1.6	6.5																○							
APKT11T3XR										●								●							

● Ex stock ○ On demand

HC¹ Coated carbide
 HT Uncoated cermet
 HC² Coated cermet
 HW Uncoated carbide

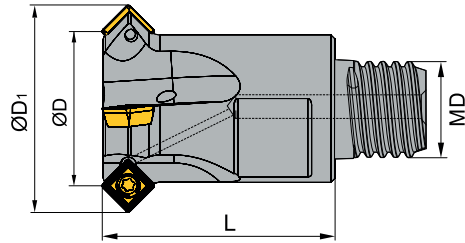
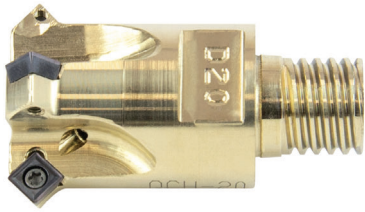

QCH series

QCH-SPGT-Q



Article	*	Stock	Dimensions [mm]				Teeth	kg	Inserts
			ØD	ØD ₁	L	MD			
QCH-16-SPGT05-Q10-45-03	*	○	16	22.6	25	10	3	0.032	SPGT0502
QCH-20-SPGT05-Q12-45-04	*	○	20	26.6	30	12	4	0.644	

- Ex stock ○ On demand
- * With internal cooling

Spare parts		
	Insert	SPGT0502
	ØD	16-20
	Screw (insert)	I60M2×4.3 (0.5 Nm)
	Wrench (insert)	WT06IP

System code > B26

Grade selection > B24

Technical info > B527

Cutting data > B230

A

Turning

B

Milling

C

Drilling



D

Technical Information



E

Index

SPGT
05 02

-  Ideal machining conditions
-  Normal machining conditions
-  Unfavourable machining conditions

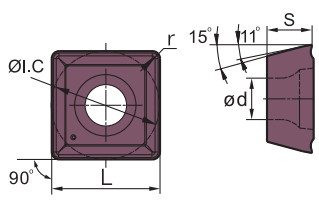
Milling inserts

SP** drilling insert		HC ¹ (CVD)						HC ¹ (PVD)					HT	HC ²	HW									
	P																							
	M																							
	K																							
	N																							
	S																							
	H																							
ISO		YBC302	YBC301	YBC401	YBM253	YBM251	YBM351	YBD152	YBD252	YBG101	YBG102	YBG202	YBG212	YBS203	YBG205	YB9320	YBG302	YBS303	YBG252	YNG151	YNG151C	YD101	YD201	
	SPGT050204-EM												●		●									
	SPGT050204-PM												●		●									

● Ex stock ○ On demand

HC¹ Coated carbide
HT Uncoated cermet
HC² Coated cermet
HW Uncoated carbide

A

Turning

B

Milling

C

Drilling

D

Technical Information

E

Index

System code > B26

Grade selection > B24

Technical info > B527

Cutting data > B230



A

Indexable heads shanks

Solid carbide shank, stepped, Q thread

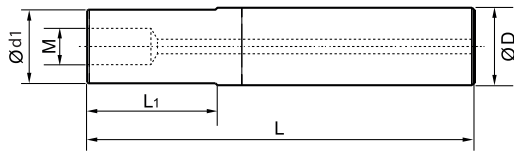

Turning

B

Milling

Article	Dimensions [mm]				Thread (M)	Stock
	D	d1	L	L1		
G12-QCH-Q08-80C	12	11,5	80	30	Q8	●
G12-QCH-Q08-100C	12	11,5	100	50	Q8	●
G12-QCH-Q08-120C	12	11,5	120	70	Q8	●
G16-QCH-Q10-90C	16	15,2	90	40	Q10	●
G16-QCH-Q10-120C	16	15,2	120	70	Q10	●
G16-QCH-Q10-150C	16	15,2	150	100	Q10	●
G20-QCH-Q12-100C	20	19	100	40	Q12	●
G20-QCH-Q12-140C	20	19	140	80	Q12	●
G20-QCH-Q12-180C	20	19	180	120	Q12	●
G25-QCH-Q14-120C	25	24	120	50	Q14	●
G25-QCH-Q14-170C	25	24	170	100	Q14	●
G25-QCH-Q14-220C	25	24	220	150	Q14	●
G32-QCH-Q18-140C	32	30	140	70	Q18	●
G32-QCH-Q18-200C	32	30	200	130	Q18	●
G32-QCH-Q18-260C	32	30	260	190	Q18	●
G32-QCH-Q18-320C	32	30	320	250	Q18	●

C

Drilling

Solid carbide shank, tapered, Q thread

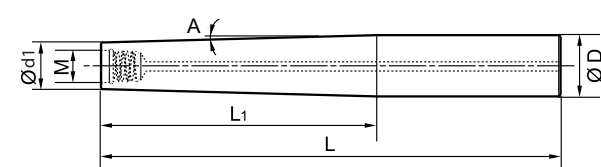

D

Technical Information

Article	Dimensions [mm]				Thread (M)	Angle (A)	Stock
	D	d1	L	L1			
G16-QCH-Q08-140C-ZJ90	16	11,5	140	90	Q8	1,0	●
G20-QCH-Q10-200C-ZJ140	20	15,2	200	140	Q8	0,8	●
G25-QCH-Q12-250C-ZJ180	25	19	250	180	Q8	0,8	●
G32-QCH-Q14-270C-ZJ200	32	30	270	200	Q10	0,8	●

E

Index

Spare parts				
	Thread	Q8 / Q10	Q12 / Q14	Q18
	Wrench	QCH-10x13	QCH-16x20	QCH-26

Indexable heads shanks

Steel shank, stepped, Q thread

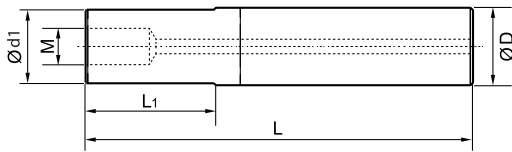

Article	Dimensions [mm]				Thread (M)	Stock
	D	d1	L	L1		
G12-QCH-Q08-65S	12	11,5	65	19	Q08	●
G16-QCH-Q10-100S	16	15,2	100	42	Q10	●
G20-QCH-Q12-110S	20	19	110	54	Q12	●

Solid carbide shank, stepped, metric thread

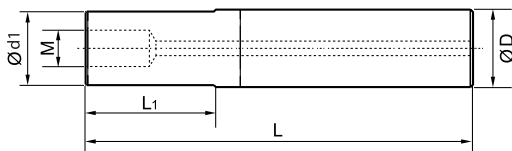

Article	Dimensions [mm]				Thread (M)	Stock
	D	d1	L	L1		
G16-QCH-M8-90C-125	16	12,5	90	35	M8	○
G16-QCH-M8-110C-125	16	12,5	110	55	M8	○
G16-QCH-M8-130C-125	16	12,5	130	75	M8	○
G16-QCH-M8-90C	16	15	90	35	M8	○
G16-QCH-M8-110C	16	15	110	55	M8	○
G16-QCH-M8-130C	16	15	130	75	M8	○
G16-QCH-M8-170C	16	15	170	115	M8	○
G16-QCH-M8-200C	16	15	200	145	M8	○
G20-QCH-M10-87C	20	18,5	87	30	M10	○
G20-QCH-M10-107C	20	18,5	107	50	M10	○
G20-QCH-M10-127C	20	18,5	127	70	M10	○
G20-QCH-M10-167C	20	18,5	167	110	M10	○
G20-QCH-M10-197C	20	18,5	197	140	M10	○
G25-QCH-M12-128C	25	23	128	65	M12	○
G25-QCH-M12-148C	25	23	148	85	M12	○
G25-QCH-M12-168C	25	23	168	105	M12	○
G25-QCH-M12-198C	25	23	198	135	M12	○
G25-QCH-M12-228C	25	23	228	165	M12	○
G32-QCH-M16-161C	32	29	161	95	M16	○
G32-QCH-M16-211C	32	29	211	145	M16	○
G32-QCH-M16-281C	32	29	281	215	M16	○
G32-QCH-M16-311C	32	29	311	245	M16	○
G32-QCH-M16-361C	32	29	361	295	M16	○

A

Turning

B

Milling

C

Drilling

D

Technical Information

E

Index

A

Turning

B

Milling

C

Drilling

D

Technical Information

E

Index

- Ideal machining conditions
- Normal machining conditions
- Unfavourable machining conditions

HNGX	L	I.C	S
09 05	9.16	15.875	5.56

Milling inserts

HN** milling insert			HC ¹ (CVD)							HC ¹ (PVD)					HT	HC ²	HW							
	P		●	●	●	●	●	●	●	●	●	●	●	●	●	●								
	M		●	●	●	●	●	●	●	●	●	●	●	●	●	●								
	K									●							●							
	N									●						●	●							
	S			●	●					●	●	●	●	●	●									
	H																							
ISO		r	YBC302	YBC301	YBC401	YBM253	YBM251	YBM351	YBD152	YBD252	YBG101	YBG102	YBG202	YBG212	YBS203	YBG205	YB9320	YBG302	YBS303	YBG252	YNG151	YNG151C	YD101	YD201
	HNGX090530-HDR	3							○	○														
	HNGX090516-MR	1.6							●															
	HNGX090520-MR	2							●															

● Ex stock ○ On demand

HC¹ Coated carbide
 HT Uncoated cermet
 HC² Coated cermet
 HW Uncoated carbide

System code > B26

Grade selection > B24

Technical info > B527



Cutting data > B230



- Ideal machining conditions
- ⊗ Normal machining conditions
- ⊗ Unfavourable machining conditions

LNE3	L	I.W	S
2.53	15.875	4.76	9.525

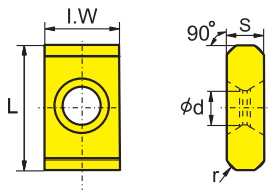
Milling inserts

LN** milling insert		HC ¹ (CVD)						HC ¹ (PVD)						HT	HC ²	HW								
	P	⊗	⊗	⊗	⊗	⊗	⊗	⊗	⊗	⊗	⊗	⊗	⊗	●	●	●								
	M	⊗	⊗	⊗	⊗	⊗	⊗	⊗	⊗	⊗	⊗	⊗	⊗	●	●	●								
	K							⊗								⊗								
	N							⊗							⊗	⊗								
	S		⊗		⊗			⊗	⊗	⊗	⊗	⊗	⊗											
	H																							
	ISO	r	YBC302	YBC301	YBC401	YBM253	YBM251	YBM351	YBD152	YBD252	YBG101	YBG102	YBG202	YBG212	YBS203	YBG205	YB9320	YBG302	YBS303	YBG252	YNG151	YNG151C	YD101	YD201
	LNE32.534	1.6					○	○	○															

● Ex stock ○ On demand

HC¹ Coated carbide
 HT Uncoated cermet
 HC² Coated cermet
 HW Uncoated carbide

A Turning

B Milling

C Drilling

D Technical Information

E Index

System code > B26

Grade selection > B24

Technical info > B527

Cutting data > B230



A

Turning

B

Milling

C

Drilling

D

Technical Information

E

Index

- Ideal machining conditions
- Normal machining conditions
- Unfavourable machining conditions

LNCX	L	I.W	S
18 06	24	10	6.4

Milling inserts

LN** milling insert		HC ¹ (CVD)						HC ¹ (PVD)						HT	HC ²	HW								
	P	●	●	●	●	●	●	●	●	●	●	●	●	●	●	●								
	M	●	●	●	●	●	●	●	●	●	●	●	●	●	●	●								
	K							●								●								
	N							●							●	●								
	S		●	●				●	●	●	●	●	●			●								
	H																							
ISO		bs	YBC302	YBC301	YBC401	YBM253	YBM251	YBM351	YBD152	YBD252	YBG101	YBG102	YBG202	YBG212	YBS203	YBG205	YB9320	YBG302	YBS303	YBG252	YNG151	YNG151C	YD101	YD201
	LNCX1806AZT11L	2.0							○															
	LNCX1806AZT11R	2.0							○															

● Ex stock ○ On demand

HC¹ Coated carbide
 HT Uncoated cermet
 HC² Coated cermet
 HW Uncoated carbide



- Ideal machining conditions
- ⊗ Normal machining conditions
- ⊗ Unfavourable machining conditions

SNKN	L	I.C	S
12 04	12.7	12.7	4.76
15 04	15.875	15.875	4.76

Milling inserts

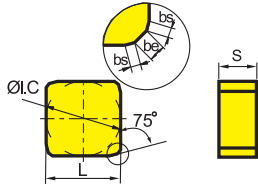

SN** milling insert			HC ¹ (CVD)						HC ¹ (PVD)						HT	HC ²	HW							
ISO	bs	be	P	⊗	⊗	⊗	⊗	⊗	⊗	⊗	⊗	⊗	⊗	⊗	⊗	⊗	●	●	●					
			M	⊗	⊗	⊗	⊗	⊗	⊗	⊗	⊗	⊗	⊗	⊗	⊗	⊗	⊗	●	●	●				
			K							⊗							●							
			N							⊗								⊗	⊗					
			S	⊗	⊗					⊗	⊗	⊗	⊗	⊗	⊗				⊗					
			H																					
			YBC302	YBC301	YBC401	YBM253	YBM251	YBM351	YBD152	YBD252	YBG101	YBG102	YBG202	YBG212	YBS203	YBG205	YB9320	YBG302	YBS303	YBG252	YNG151	YNG151C	YD101	YD201
	SNKN1204ENN	1.5	0.9	●				●	●															
	SNKN1504ENN	1.5	0.9	○																				

● Ex stock ○ On demand

HC¹ Coated carbide
 HT Uncoated cermet
 HC² Coated cermet
 HW Uncoated carbide

A

Turning

B

Milling

C

Drilling

D

Technical Information

E

Index



Indexable milling General milling inserts

A

Turning

B

Milling

C

Drilling

D

Technical Information

E

Index

- Ideal machining conditions
- ⊗ Normal machining conditions
- ⊗ Unfavourable machining conditions

SPCN	L	I.C	S
12 03	12.7	12.7	1.4
15 04	15.875	15.875	1.4

Milling inserts

SP** milling insert		HC ¹ (CVD)								HC ¹ (PVD)								HT	HC ²	HW					
		P																							
	M																								
	K																								
	N																								
	S																								
	H																								
ISO		bs	be	YBC302	YBC301	YBC401	YBM253	YBM251	YBM351	YBD152	YBD252	YBG101	YBG102	YBG202	YBG212	YBS203	YBG205	YB9320	YBG302	YBS303	YBG252	YNG151	YNG151C	YD101	YD201
	SPCN1203EDSKR	3.2	1.0	●																					
	SPCN1504EDSKR	4.8	1.0	●																					

● Ex stock ○ On demand

HC¹ Coated carbide
 HT Uncoated cermet
 HC² Coated cermet
 HW Uncoated carbide



- Ideal machining conditions
- ⊗ Normal machining conditions
- ⊗ Unfavourable machining conditions

SPMR	L	I.C	S
09 03	9.525	9.525	3.18
12 03	12.7	12.7	3.18

Milling inserts

SP** milling insert		HC ¹ (CVD)						HC ¹ (PVD)						HT	HC ²	HW								
	P	⊗	⊗	⊗	⊗	⊗	⊗	⊗	⊗	⊗	⊗	⊗	⊗	●	●	●								
	M	⊗	⊗	⊗	⊗	⊗	⊗	⊗	⊗	⊗	⊗	⊗	⊗	●	●	●								
	K															⊗								
	N							⊗							⊗	⊗								
	S		⊗	⊗				⊗	⊗	⊗	⊗	⊗	⊗											
	H																							
ISO		r	YBC302	YBC301	YBC401	YBM253	YBM251	YBM351	YBD152	YBD252	YBG101	YBG102	YBG202	YBG212	YBS203	YBG205	YB9320	YBG302	YBS303	YBG252	YNG151	YNG151C	YD101	YD201
	SPMR090304	0.4				○																		
	SPMR090308	0.8				○																		
	SPMR120304	0.4				●																		
	SPMR120308	0.8				●	○																	
	SPMR120312	1.2					○																	

● Ex stock ○ On demand

HC¹ Coated carbide
 HT Uncoated cermet
 HC² Coated cermet
 HW Uncoated carbide

A Turning
B Milling
C Drilling
D Technical Information
E Index

A

Turning

B

Milling

C

Drilling

D

Technical Information

E

Index

- Ideal machining conditions
- Normal machining conditions
- Unfavourable machining conditions

SPMT	L	I.C	S	d
06 03	6.35	6.35	3.18	2.8
09 T3	9.525	9.525	3.97	4.4
12 04	12.7	12.7	4.76	5.5

Milling inserts

SP** milling insert			HC ¹ (CVD)						HC ¹ (PVD)						HT	HC ²	HW							
	P	●	●	●	●	●	●	●	●	●	●	●	●	●	●									
	M	●	●	●	●	●	●	●	●	●	●	●	●	●	●									
	K																							
	N																							
	S																							
	H																							
	ISO	r	YBC302	YBC301	YBC401	YBM253	YBM251	YBM351	YBD152	YBD252	YBG101	YBG102	YBG202	YBG212	YBS203	YBG205	YB9320	YBG302	YBS303	YBG252	YNG151	YNG151C	YD101	YD201
HT-1	SPMT120408-HT-1	0.8												○										
HT	SPMT09T308-HT	0.8				●		●					○											
KT	SPMT060304-KT	0.4												○										

● Ex stock ○ On demand

HC¹ Coated carbide
 HT Uncoated cermet
 HC² Coated cermet
 HW Uncoated carbide





- Ideal machining conditions
- Normal machining conditions
- Unfavourable machining conditions

SP**	L	I.C	S
12 03	12.7	12.7	3.18
15 04	15.875	15.875	4.76

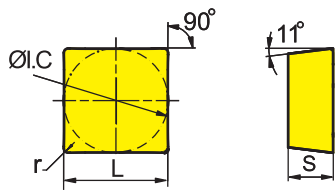
Milling inserts



SP** milling insert			HC ¹ (CVD)						HC ¹ (PVD)						HT	HC ²	HW								
	P		●	●	●	●	●	●	●	●	●	●	●	●	●										
	M		●	●	●	●	●	●	●	●	●	●	●	●	●										
	K								●								●								
	N								●								●								
	S			●	●				●	●	●	●	●	●											
	H																								
	ISO	r	YBC302	YBC301	YBC401	YBM253	YBM251	YBM351	YBD152	YBD252	YBG101	YBG102	YBG202	YBG212	YBS203	YBG205	YB9320	YBG302	YBS303	YBG252	YNG151	YNG151C	YD101	YD201	
	SPGN120304	0.4											○												
	SPGN120308	0.8											○												
	SPUN120308	0.8					●	○																	○
	SPUN120312	1.2					●																		
	SPUN150408	0.8																							○
	SPUN150412	1.2																							○

● Ex stock ○ On demand

HC¹ Coated carbide
 HT Uncoated cermet
 HC² Coated cermet
 HW Uncoated carbide

A

Turning

B

Milling

C

Drilling

D

Technical Information

E

Index



A

Turning

B

Milling

C

Drilling

D

Technical Information

E

Index

- Ideal machining conditions
- ⊗ Normal machining conditions
- ⊗ Unfavourable machining conditions

TPKN	L	I.C	S
16 03	16.5	9.525	3.18

Milling inserts

TP** milling insert				HC ¹ (CVD)						HC ¹ (PVD)						HT	HC ²	HW		
	P	⊗	⊗	⊗	⊗	⊗	⊗	⊗	⊗	⊗	⊗	⊗	⊗	⊗	⊗	⊗	⊗	⊗	⊗	⊗
	M	⊗	⊗	⊗	⊗	⊗	⊗	⊗	⊗	⊗	⊗	⊗	⊗	⊗	⊗	⊗	⊗	⊗	⊗	⊗
	K									⊗										⊗
	N									⊗									⊗	⊗
	S									⊗	⊗	⊗	⊗	⊗	⊗	⊗	⊗			⊗
	H																			

ISO		bs	be	an	YBC302	YBC301	YBC401	YBM253	YBM251	YBM351	YBD152	YBD252	YBG101	YBG102	YBG202	YBG212	YBS203	YBG205	YB9320	YBG302	YBS303	YBG252	YNG151	YNG151C	YD101	YD201	
	TPKN1603PDTKR	1.0	1.2	11																						○	
	TPKN1603PPER	1.0	1.2	11	●																						○
	TPKN1603PPFR	1.0	1.2	11																							○

● Ex stock ○ On demand

HC¹ Coated carbide
 HT Uncoated cermet
 HC² Coated cermet
 HW Uncoated carbide

System code > B26

Grade selection > B24

Technical info > B527

Cutting data > B230

TP**	L	I.C	S
11 03	11	6.35	3.18
16 03	16.5	9.525	3.18
22 04	22	12.7	4.76

- Ideal machining conditions
- ⊗ Normal machining conditions
- ⊗ Unfavourable machining conditions

Milling inserts

TP** milling insert			HC ¹ (CVD)						HC ¹ (PVD)						HT	HC ²	HW							
	P		⊗	⊗	⊗	⊗	⊗	⊗	⊗	⊗	⊗	⊗	⊗	⊗	●	●	●							
	M		⊗	⊗	⊗	⊗	⊗	⊗	⊗	⊗	⊗	⊗	⊗	⊗	●	●	●							
	K								⊗						●		⊗							
	N								⊗								⊗							
	S			⊗	⊗				⊗	⊗	⊗	⊗	⊗	⊗										
	H																							
	ISO	r	YBC302	YBC301	YBC401	YBM253	YBM251	YBM351	YBD152	YBD252	YBG101	YBG102	YBG202	YBG212	YBS203	YBG205	YB9320	YBG302	YBS303	YBG252	YNG151	YNG151C	YD101	YD201
	TPMR110304	0.4				●																		
	TPMR110308	0.8				●																		
	TPMR160304	0.4				●																		
	TPMR160308	0.8				●	●	○																
	TPMR160312	1.2				○																		
	TPMR220412	1.2				●																		
	TPUN110304	0.4				●																		
	TPUN110308	0.8				●																		
	TPUN160304	0.4				●																	○	
	TPUN160308	0.8				●	○							○										○
	TPUN160312	1.2				●																		
	TPUN220408	0.8				●																		
TPUN220412	1.2						○																	

● Ex stock ○ On demand

HC¹ Coated carbide
 HT Uncoated cermet
 HC² Coated cermet
 HW Uncoated carbide

A

Turning

B

Milling

C

Drilling

D

Technical Information

E

Index



Guide for recommended cutting data – indexable milling

Indexable milling – group 1 (FMA07/11/12, FMD02, EMP09/13)

Material group	Composition / structure / heat treatment	Brinell hardness HB	Machining group	Starting values for cutting speed v_c (m/min)								
				HC (CVD)								
				YBC302		YBC401		YBD152		YBD252		
				a_p / D		a_p / D		a_p / D		a_p / D		
1/1 3/4		1/5		1/1 3/4		1/5		1/1 3/4		1/5		
P Unalloyed steel	ca. 0,15 % C	annealed	125	1	260	300	225	260				
	ca. 0,45 % C	annealed	190	2	225	255	195	225				
	ca. 0,45 % C	tempered	250	3	210	240	180	210				
	ca. 0,75 % C	annealed	270	4	185	210	160	185				
	ca. 0,75 % C	tempered	300	5	170	195	150	170				
P Low-alloyed steel		annealed	180	6	225	255	195	225				
		tempered	275	7	185	210	160	185				
		tempered	300	8	170	195	150	170				
		tempered	350	9	145	165	125	145				
P High-alloyed steel and high-alloyed tool steel		annealed	200	10	130	150	115	130				
		hardened and tempered	325	11	95	105	80	95				
M Stainless steel	ferritic/martensitic	annealed	200	12								
	martensitic	tempered	240	13								
	austenitic	quench hardened	180	14								
	austenitic-ferritic		230	15								
K Grey cast iron	perlitic/ferritic		180	16				370	430	320	370	
	perlitic (martensitic)		260	17				220	255	190	220	
K Cast iron with spheroidal graphite	ferritic		160	18				255	295	220	255	
	perlitic		250	19				170	200	145	170	
K Malleable cast iron	ferritic		130	20				305	355	265	305	
	perlitic		230	21				205	240	175	205	
N Aluminium wrought alloys	cannot be hardened		60	22								
	hardenable	hardened	100	23								
	≤ 12 % Si, cannot be hardened		75	24								
	≤ 12 % Si, hardenable	hardened	90	25								
N Cast aluminium alloys	> 12 % Si, cannot be hardened		130	26								
	machining steel, PB > 1%		110	27								
	CuZn, CuSnZn		90	28								
S Copper and copper alloys (bronze/brass)	CuSn, Pb-free copper, electrolytic copper		100	29								
	Heat-resistant alloys	Fe-based alloys	annealed	200	30							
		hardened	280	31								
	Ni or Co base	annealed	250	32								
hardened		350	33									
Titanium alloys	cast	320	34									
	pure titanium		R _m 400	35								
H Hardened steel	α and β alloys	hardened	R _m 1050	36								
	hardened and tempered		55 HRC	37								
H Hard cast iron	hardened and tempered		60 HRC	38								
	cast		400	39								
H Hardened cast iron	hardened and tempered		55 HRC	40								
	Thermoplasts			41								
X Non-metallic materials	Thermosetting plastics			42								
	Plastic, glass-fibre reinforced GFRP			43								
	Plastic, carbon fibre reinforced CFRP			44								
	Graphite			45								
	Wood			46								

Note: The given cutting values are guide values, which were determined under ideal conditions.

The values have to be adapted in individual cases.

Feed rate recommendations on page B248

For examples of material for cutting tool groups view page D22.

Recommend feed rate

Indexable milling – group1 (FMA07/11/12, FMD02, EMP09/13)

5	Material group	Feed rate per cutting edge [mm]																			
		EMP09			EMP13			EMP13			FMA07			FMA07			FMA11				
		LNKT12			ANGX11			ANGX15			ONHU06			ONHU08			SNEG12				
		Application																			
		F	M	R	F	M	R	F	M	R	F	M	R	F	M	R	F	M	R		
P	Unalloyed steel		0,25	0,50		0,23			0,25		0,19	0,23		0,19	0,23		0,20	0,23			
	Low-alloyed steel		0,23	0,47		0,22			0,23		0,17	0,22		0,17	0,22		0,19	0,21			
	High-alloyed steel and high-alloyed tool steel		0,22	0,44		0,20			0,22		0,16	0,20		0,16	0,20		0,18	0,20			
M	Stainless steel		0,18	0,35													0,14	0,16			
K	Grey cast iron		0,28	0,55		0,26			0,28		0,20	0,26		0,20	0,26		0,22	0,25			
	Cast iron with spheroidal graphite		0,25	0,50		0,23			0,25		0,19	0,23		0,19	0,23		0,20	0,23			
	Malleable cast iron		0,25	0,50		0,23			0,25		0,19	0,23		0,19	0,23		0,20	0,23			
N	Aluminium wrought alloys					0,20			0,21												
	Aluminium-Gusslegierungen					0,20			0,21												
	Copper and copper alloys (bronze/brass)					0,18			0,19												
S	Heat-resistant alloys																				
	Titanium alloys																				
H	Hardened steel																				
	Hard cast iron																				
	Hardened cast iron																				
X	Non-metallic materials																				

A

Turning

B

Milling

C

Drilling

D

Technical Information

E

Index

1. Select the appropriate product family/cutting data group.
2. Select the used grade.
3. Determine the immersion.
4. Select the used material and read the cutting speed.
5. Please have a look at the detached feed rate recommendations.
6. Select the used tool, the machining mode and the used material.



Indexable milling – group 1 (FMA07/11/12, FMD02, FMP12, EMP09/13)

	Material group	Composition / structure / heat treatment		Brinell hardness HB	Machining group	Starting values for cutting speed v_c [m/min]							
						HC (CVD)							
						YBC302		YBC401		YBD152		YBD252	
						a_e / D		a_e / D		a_e / D		a_e / D	
1/1 3/4		1/5		1/1 3/4		1/5		1/1 3/4		1/5			
A Turning	P Unalloyed steel	approx. 0,15 % C	annealed	125	1	260	300	225	260				
		approx. 0,45 % C	annealed	190	2	225	255	195	225				
		approx. 0,45 % C	tempered	250	3	210	240	180	210				
		approx. 0,75 % C	annealed	270	4	185	210	160	185				
		approx. 0,75 % C	tempered	300	5	170	195	150	170				
B Milling	P Low-alloyed steel		annealed	180	6	225	255	195	225				
			tempered	275	7	185	210	160	185				
			tempered	300	8	170	195	150	170				
			tempered	350	9	145	165	125	145				
		High-alloyed steel and high-alloyed tool steel		annealed	200	10	130	150	115	130			
			hardened and tempered	325	11	95	105	80	95				
C Drilling	M Stainless steel	ferritic/martensitic	annealed	200	12								
			martensitic	tempered	240	13							
			austenitic	quench hardened	180	14							
			austenitic-ferritic		230	15							
D Technical Information	K Grey cast iron		perlitic/ferritic	180	16					370	430	320	370
			perlitic (martensitic)	260	17					220	255	190	220
	K Cast iron with spheroidal graphite		ferritic	160	18					255	295	220	255
			perlitic	250	19					170	200	145	170
	K Malleable cast iron		ferritic	130	20					305	355	265	305
			perlitic	230	21					205	240	175	205
E Index	N Aluminium wrought alloys		cannot be hardened	60	22								
			hardenable	hardened	100	23							
	N Cast aluminium alloys		$\leq 12\% \text{ Si}$, cannot be hardened		75	24							
			$\leq 12\% \text{ Si}$, hardenable	hardened	90	25							
			$> 12\% \text{ Si}$, cannot be hardened		130	26							
	N Copper and copper alloys (bronze/brass)		machining steel, PB > 1%		110	27							
			CuZn, CuSnZn		90	28							
		CuSn, Pb-free copper, electrolytic copper		100	29								
F Index	S Heat-resistant alloys	Fe-based alloys	annealed	200	30								
			hardened	280	31								
		Ni or Co base	annealed	250	32								
			hardened	350	33								
		cast	320	34									
S Titanium alloys		pure titanium		$R_m 400$	35								
		α and β alloys	hardened	$R_m 1050$	36								
H Hardened steel			hardened and tempered	55 HRC	37								
			hardened and tempered	60 HRC	38								
		Hard cast iron	cast	400	39								
	Hardened cast iron		hardened and tempered	55 HRC	40								
X Non-metallic materials			Thermoplasts		41								
			Thermosetting plastics		42								
			Plastic, glass-fibre reinforced GFRP		43								
			Plastic, carbon fibre reinforced CFRP		44								
			Graphite		45								
			Wood		46								

Note: The given cutting values are guide values, which were determined under ideal conditions.
 The values have to be adapted in individual cases.
 Feed rate recommendations on page B254.
 For examples of material for cutting tool groups view page D11.

Starting values for cutting speed v_c [m/min]															
HC (CVD)		HC (PVD)										HW			
YBM253		YBG102		YB9320		YBG205		YBG252		YBG302		YD101		YD201	
a_e / D		a_e / D		a_e / D		a_e / D		a_e / D		a_e / D		a_e / D		a_e / D	
1/1 3/4	1/5	1/1 3/4	1/5	1/1 3/4	1/5	1/1 3/4	1/5	1/1 3/4	1/5	1/1 3/4	1/5	1/1 3/4	1/5	1/1 3/4	1/5
260	300	270	315	245	285	235	275	230	265	225	260				
225	255	230	270	210	245	200	235	200	230	195	225				
210	240	220	255	200	230	190	220	185	215	180	210				
185	210	190	225	175	200	165	195	165	190	160	185				
170	195	180	205	160	190	155	180	150	175	150	170				
225	255	230	270	210	245	200	235	200	230	195	225				
185	210	190	225	175	200	165	195	165	190	160	185				
170	195	180	205	160	190	155	180	150	175	150	170				
145	165	150	175	135	160	130	155	130	150	125	145				
130	150	135	160	125	145	120	140	115	135	115	130				
95	105	95	115	90	100	85	100	85	95	80	95				
130	150	135	160	125	145	120	140	115	135	115	130				
110	130	115	135	105	120	100	120	100	115	95	110				
140	160	145	170	130	155	125	150	125	145	120	140				
110	130	115	135	105	120	100	120	100	115	95	110				
		300	345	270	315	260	300	255	295	250	290				
		180	205	160	190	155	180	150	175	150	170				
		205	240	185	215	180	210	175	200	170	195				
		135	160	125	145	120	140	115	135	115	130				
		245	285	225	260	215	250	210	240	205	235				
		165	190	150	175	145	165	140	160	135	160				
												1505	1735	1450	1670
												1225	1420	1180	1370
												540	620	515	600
												435	505	420	485
												220	255	215	250
												170	195	160	190
												210	245	205	235
												385	445	370	430

HC Coated carbide
 HT Uncoated carbide, main component (TiC) o. (TiN), cermet
 HC₁ Coated cermet
 HW Uncoated carbide, main component (WC)

A
Turning
B
Milling
C
Drilling
D
Technical Information
E
Index



Indexable milling – group 2 (FMA01/02/03/04, FME01/02, FMP01/02, EMP01/02/03/04)

	Material group	Composition / structure / heat treatment		Brinell hardness HB	Machining group	Starting values for cutting speed v_c [m/min]								
						HC (CVD)								
						YBC302		YBC401		YBD152		YBD252		
						a_e / D		a_e / D		a_e / D		a_e / D		
1/1 3/4		1/5		1/1 3/4		1/5		1/1 3/4		1/5				
A Turning	P Unalloyed steel	approx. 0,15 % C	annealed	125	1	245	285	210	245					
		approx. 0,45 % C	annealed	190	2	210	245	180	210					
		approx. 0,45 % C	tempered	250	3	200	230	170	200					
		approx. 0,75 % C	annealed	270	4	175	200	150	175					
		approx. 0,75 % C	tempered	300	5	160	190	140	160					
B Milling	P Low-alloyed steel		annealed	180	6	210	245	180	210					
			tempered	275	7	175	200	150	175					
			tempered	300	8	160	190	140	160					
			tempered	350	9	135	160	120	135					
		High-alloyed steel and high-alloyed tool steel		annealed	200	10	125	145	105	125				
			hardened and tempered	325	11	90	100	75	90					
C Drilling	M Stainless steel	ferritic/martensitic	annealed	200	12									
			martensitic	tempered	240	13								
			austenitic	quench hardened	180	14								
			austenitic-ferritic		230	15								
			Grey cast iron	perlitic/ferritic		180	16				315	365	270	315
D Technical Information	K Cast iron with spheroidal graphite		perlitic (martensitic)		260	17				185	215	160	190	
			ferritic		160	18				215	250	185	215	
			perlitic		250	19				145	170	125	145	
			ferritic		130	20				260	300	225	260	
			perlitic		230	21				175	205	150	175	
E Index	N Aluminium wrought alloys	cannot be hardened		60	22									
			hardenable	hardened	100	23								
		Cast aluminium alloys	$\leq 12\% \text{ Si}$, cannot be hardened		75	24								
				$\leq 12\% \text{ Si}$, hardenable	hardened	90	25							
				$> 12\% \text{ Si}$, cannot be hardened		130	26							
F Index	S Copper and copper alloys (bronze/brass)	machining steel, PB > 1%		110	27									
			CuZn, CuSnZn		90	28								
			CuSn, Pb-free copper, electrolytic copper		100	29								
		Heat-resistant alloys	Fe-based alloys	annealed	200	30								
				hardened	280	31								
Ni or Co base	annealed		250	32										
	hardened		350	33										
	cast	320	34											
H Hardened steel	Titanium alloys	pure titanium		R_m 400	35									
			α and β alloys	hardened	R_m 1050	36								
	Hardened steel			hardened and tempered	55 HRC	37								
				hardened and tempered	60 HRC	38								
				cast	400	39								
	Hardened cast iron			hardened and tempered	55 HRC	40								
X Non-metallic materials	Non-metallic materials	Thermoplasts			41									
		Thermosetting plastics			42									
		Plastic, glass-fibre reinforced GFRP			43									
		Plastic, carbon fibre reinforced CFRP			44									
		Graphite			45									
		Wood			46									

Note: The given cutting values are guide values, which were determined under ideal conditions.
 The values have to be adapted in individual cases.
 Feed rate recommendations on page B254.
 For examples of material for cutting tool groups view page D11.

Starting values for cutting speed v_c [m/min]																					
HC (CVD)				HC (PVD)												HW				HT	
YBM253		YBG101		YBG102		YBG152		YB9320		YBG205		YBG252		YBG302		YD101		YD201		YNG151	
a_e / D		a_e / D		a_e / D		a_e / D		a_e / D		a_e / D		a_e / D		a_e / D		a_e / D		a_e / D		a_e / D	
1/1 3/4	1/5	1/1 3/4	1/5	1/1 3/4	1/5	1/1 3/4	1/5	1/1 3/4	1/5	1/1 3/4	1/5	1/1 3/4	1/5	1/1 3/4	1/5	1/1 3/4	1/5	1/1 3/4	1/5	1/1 3/4	1/5
245	285			255	295	240	280	230	265	220	255	215	250	210	245					270	315
210	245			220	255	205	240	200	230	190	220	185	215	180	210					235	270
200	230			205	240	195	225	185	215	180	205	175	200	170	200					220	255
175	200			180	210	170	200	165	190	155	180	155	175	150	175					195	220
160	190			170	195	160	185	150	175	145	170	140	165	140	160					180	210
210	245			220	255	205	240	200	230	190	220	185	215	180	210					235	270
175	200			180	210	170	200	165	190	155	180	155	175	150	175					195	220
160	190			170	195	160	185	150	175	145	170	140	165	140	160					180	210
135	160			145	165	135	155	130	150	125	145	120	140	120	135					150	180
125	145			130	150	120	140	115	135	110	130	110	125	105	125					140	160
90	100			90	105	85	100	85	95	80	90	80	90	75	90					100	110
125	145			130	150	120	140	115	135	110	130	110	125	105	125					135	160
105	120			110	125	105	120	100	115	95	110	95	105	90	105					115	135
130	155			140	160	130	150	125	145	120	140	115	135	115	130					145	170
105	120			110	125	105	120	100	115	95	110	95	105	90	105					115	135
				285	330	265	305	255	295	245	285	240	280	235	275						
				170	195	160	185	150	175	145	170	140	165	140	160						
				195	225	180	210	175	200	165	195	165	190	160	185						
				130	150	120	140	115	135	110	130	110	125	105	125						
				230	270	220	255	210	240	200	230	195	225	190	225						
				155	180	145	170	140	160	135	155	130	150	130	150						
		1505	1735													1205	1390	1040	1200		
		1225	1420													980	1140	850	980		
		540	620													435	500	375	435		
		435	505													350	405	300	350		
		220	255													180	205	155	180		
		170	195													140	160	120	140		
		210	245													170	200	150	170		
		385	445													310	360	265	310		
				75	85	70	80	65	75	65	75	65	75	60	70						
				50	55	50	55	45	50	45	50	45	50	40	45						
				60	70	55	65	55	65	50	55	50	55	50	55						
				35	40	35	40	30	35	30	35	30	35	30	35						
				45	50	45	50	40	45	40	45	40	45	40	45						
				75	85	70	80	65	75	65	75	65	75	60	70						
				75	85	70	80	65	75	65	75	65	75	60	70						

HC Coated carbide
 HT Uncoated carbide, main component (TiC) o. (TiN), cermet
 HC₁ Coated cermet
 HW Uncoated carbide, main component (WC)

A

Turning

B

Milling

C

Drilling

D

Technical Information

E

Index

Indexable milling – group 2 (FMA01/02/03/04, FME01/02, FMP01/02, EMP01/02/03/04)

Material group	Composition / structure / heat treatment		Brinell hardness HB	Machining group	Starting values for cutting speed vc [m/min]				
					HC ₁				
					YNG151C				
					a _e / D				
					1/1 3/4	1/5			
P Unalloyed steel	approx. 0,15 % C	annealed	125	1	285	335			
	approx. 0,45 % C	annealed	190	2	250	285			
	approx. 0,45 % C	tempered	250	3	235	270			
	approx. 0,75 % C	annealed	270	4	205	235			
	approx. 0,75 % C	tempered	300	5	190	225			
	Low-alloyed steel		annealed	180	6	250	285		
			tempered	275	7	205	235		
			tempered	300	8	190	225		
			tempered	350	9	160	190		
	High-alloyed steel and high-alloyed tool steel		annealed	200	10	150	170		
		hardened and tempered	325	11	105	120			
M Stainless steel	ferritic/martensitic	annealed	200	12	145	170			
	martensitic	tempered	240	13	120	145			
	austenitic	quench hardened	180	14	155	180			
	austenitic-ferritic		230	15	120	145			
K Grey cast iron Cast iron with spheroidal graphite Malleable cast iron	perlitic/ferritic		180	16					
	perlitic (martensitic)		260	17					
	ferritic		160	18					
	perlitic		250	19					
	ferritic		130	20					
	perlitic		230	21					
N Aluminium wrought alloys Cast aluminium alloys Copper and copper alloys (bronze/brass)	cannot be hardened		60	22					
	hardenable	hardened	100	23					
	≤ 12% Si, cannot be hardened		75	24					
	≤ 12% Si, hardenable	hardened	90	25					
	> 12% Si, cannot be hardened		130	26					
	machining steel, PB> 1%		110	27					
S Heat-resistant alloys Titanium alloys	CuZn, CuSnZn		90	28					
	CuSn, Pb-free copper, electrolytic copper		100	29					
	Fe-based alloys	annealed	200	30					
		hardened	280	31					
		annealed	250	32					
		hardened	350	33					
Ni or Co bass	cast	320	34						
	pure titanium	R _m 400	35						
α and β alloys	hardened	R _m 1050	36						
H Hardened steel Hard cast iron Hardened cast iron	hardened and tempered		55 HRC	37					
	hardened and tempered		60 HRC	38					
	cast		400	39					
	hardened and tempered		55 HRC	40					
X Non-metallic materials	Thermoplasts			41					
	Thermosetting plastics			42					
	Plastic, glass-fibre reinforced GFRP			43					
	Plastic, carbon fibre reinforced CFRP			44					
	Graphite			45					
	Wood			46					

Note: The given cutting values are guide values, which were determined under ideal conditions.
 The values have to be adapted in individual cases.
 Feed rate recommendations on page B254.
 For examples of material for cutting tool groups view page D11.

Indexable milling – group 3 (FMR01/02/03/04)

	Material group	Composition / structure / heat treatment		Brinell hardness HB	Machining group	Starting values for cutting speed v_c [m/min]						
						HC (CVD)						
						YBC302			YBC401			
						a_e / D			a_e / D			
	1/1 3/4	1/5	1/20	1/1 3/4	1/5	1/20						
A Turning	P Unalloyed steel	approx. 0,15 % C	annealed	125	1	260	300	390	225	260	340	
		approx. 0,45 % C	annealed	190	2	225	255	335	195	225	295	
		approx. 0,45 % C	tempered	250	3	210	240	315	180	210	275	
		approx. 0,75 % C	annealed	270	4	185	210	275	160	185	245	
		approx. 0,75 % C	tempered	300	5	170	195	255	150	170	225	
	B Milling	P Low-alloyed steel		annealed	180	6	225	255	335	195	225	295
				tempered	275	7	185	210	275	160	185	245
				tempered	300	8	170	195	255	150	170	225
				tempered	350	9	145	165	215	125	145	190
	C Drilling	P High-alloyed steel and high-alloyed tool steel		annealed	200	10	130	150	195	115	130	170
			hardened and tempered	325	11	95	105	140	80	95	125	
D Technical Information	M Stainless steel	ferritic/martensitic	annealed	200	12							
			martensitic	tempered	240	13						
			austenitic	quench hardened	180	14						
			austenitic-ferritic		230	15						
E Index	K Cast iron with spheroidal graphite	perlitic/ferritic		180	16							
			perlitic (martensitic)		260	17						
	K Malleable cast iron	ferritic		160	18							
			perlitic		250	19						
F Index	N Aluminium wrought alloys	cannot be hardened		60	22							
		hardenable	hardened	100	23							
	N Cast aluminium alloys	$\leq 12\% \text{ Si}$, cannot be hardened		75	24							
		$\leq 12\% \text{ Si}$, hardenable	hardened	90	25							
H Hardened steel	N Copper and copper alloys (bronze/brass)	$> 12\% \text{ Si}$, cannot be hardened		130	26							
		machining steel, PB > 1%		110	27							
		CuZn, CuSnZn		90	28							
S Heat-resistant alloys	S Titanium alloys	CuSn, Pb-free copper, electrolytic copper		100	29							
		Fe-based alloys	annealed	200	30							
			hardened	280	31							
		Ni or Co bass	annealed	250	32							
hardened	350		33									
	cast	320	34									
H Hard cast iron	H Hardened cast iron	pure titanium		R_m 400	35							
		α and β alloys	hardened	R_m 1050	36							
			hardened and tempered	55 HRC	37							
H Hardened cast iron	H Hardened cast iron		hardened and tempered	60 HRC	38							
			cast	400	39							
X Non-metallic materials	X Non-metallic materials		hardened and tempered	55 HRC	40							
		Thermoplasts			41							
		Thermosetting plastics			42							
		Plastic, glass-fibre reinforced GFRP			43							
		Plastic, carbon fibre reinforced CFRP			44							
	Graphite			45								
	Wood			46								

Note: The given cutting values are guide values, which were determined under ideal conditions.
 The values have to be adapted in individual cases.
 Feed rate recommendations on page B254.
 For examples of material for cutting tool groups view page D11.

Starting values for cutting speed v_c [m/min]																						
HC (CVD)									HC (PVD)													
YBD152			YBD252			YBM253			YBG102			YBG152			YB9320			YBG205				
a_e / D			a_e / D			a_e / D			a_e / D			a_e / D			a_e / D			a_e / D				
1/1 3/4	1/5	1/20	1/1 3/4	1/5	1/20	1/1 3/4	1/5	1/20	1/1 3/4	1/5	1/20	1/1 3/4	1/5	1/20	1/1 3/4	1/5	1/20	1/1 3/4	1/5	1/20		
								260	300	390	270	315	410	255	295	385	245	285	375	235	275	360
								225	255	335	230	270	355	220	255	335	210	245	320	200	235	310
								210	240	315	220	255	335	205	240	315	200	230	300	190	220	290
								185	210	275	190	225	295	180	210	275	175	200	260	165	195	255
								170	195	255	180	205	270	170	195	255	160	190	250	155	180	235
								225	255	335	230	270	355	220	255	335	210	245	320	200	235	310
								185	210	275	190	225	295	180	210	275	175	200	260	165	195	255
								170	195	255	180	205	270	170	195	255	160	190	250	155	180	235
								145	165	215	150	175	230	145	165	215	135	160	210	130	155	205
								130	150	195	135	160	210	130	150	195	125	145	190	120	140	185
								95	105	140	95	115	150	90	105	140	90	100	130	85	100	130
								130	150	195	135	160	205	130	150	195	125	145	190	120	140	180
								110	130	165	115	135	175	110	125	165	105	120	160	100	120	155
								140	160	210	145	170	220	140	160	205	130	155	200	125	150	195
								110	130	165	115	135	175	110	125	165	105	120	160	100	120	155
	345	400	520	300	345	450					300	345	450	285	330	430	270	315	410	260	300	390
	210	245	320	180	205	270					180	205	270	170	195	255	160	190	250	155	180	235
	240	280	365	205	240	315					205	240	315	195	225	295	185	215	280	180	210	275
	160	185	245	135	160	210					135	160	210	130	150	195	125	145	190	120	140	185
	285	330	430	245	285	375					245	285	375	230	270	355	225	260	340	215	250	325
	190	220	290	165	190	250					165	190	250	155	180	235	150	175	230	145	165	215

HC Coated carbide
 HT Uncoated carbide, main component (TiC) o. (TiN), cermet
 HC₁ Coated cermet
 HW Uncoated carbide, main component (WC)

A
Turning
B
Milling
C
Drilling
D
Technical Information
E
Index



Indexable milling – group 3 (FMR01/02/03/04)

	Material group	Composition / structure / heat treatment		Brinell hardness HB	Machining group	Starting values for cutting speed v_c [m/min]						
						HC (PVD)						
						YBG212			YBG252			
						a_e / D			a_e / D			
	1/1 3/4	1/5	1/20	1/1 3/4	1/5	1/20						
P	Unalloyed steel	approx. 0,15 % C	annealed	125	1	240	280	365	230	265	345	
		approx. 0,45 % C	annealed	190	2	205	240	315	200	230	300	
		approx. 0,45 % C	tempered	250	3	195	225	295	185	215	280	
		approx. 0,75 % C	annealed	270	4	170	200	260	165	190	250	
		approx. 0,75 % C	tempered	300	5	160	185	245	150	175	230	
	Low-alloyed steel		annealed	180	6	205	240	315	200	230	300	
			tempered	275	7	170	200	260	165	190	250	
			tempered	300	8	160	185	245	150	175	230	
			tempered	350	9	135	155	205	130	150	195	
	High-alloyed steel and high-alloyed tool steel		annealed	200	10	120	140	185	115	135	180	
		hardened and tempered	325	11	85	100	130	85	95	125		
M	Stainless steel	ferritic/martensitic	annealed	200	12	120	140	185	115	135	175	
			martensitic	tempered	240	13	105	120	155	100	115	145
			austenitic	quench hardened	180	14	130	150	195	125	145	185
			austenitic-ferritic		230	15	105	120	155	100	115	145
K	Grey cast iron	perlitic/ferritic		180	16	265	305	400	255	295	385	
		perlitic (martensitic)		260	17	160	185	245	150	175	230	
	Cast iron with spheroidal graphite	ferritic		160	18	180	210	275	175	200	260	
		perlitic		250	19	120	140	185	115	135	180	
	Malleable cast iron	ferritic		130	20	220	255	335	210	240	315	
		perlitic		230	21	145	170	225	140	160	210	
N	Aluminium wrought alloys	cannot be hardened		60	22							
		hardenable	hardened	100	23							
	Cast aluminium alloys	$\leq 12\% \text{ Si}$, cannot be hardened		75	24							
		$\leq 12\% \text{ Si}$, hardenable	hardened	90	25							
		$> 12\% \text{ Si}$, cannot be hardened		130	26							
	Copper and copper alloys (bronze/brass)	machining steel, PB > 1%		110	27							
		CuZn, CuSnZn		90	28							
		CuSn, Pb-free copper, electrolytic copper		100	29							
S	Heat-resistant alloys	Fe-based alloys	annealed	200	30							
			hardened	280	31							
		Ni or Co base	annealed	250	32							
			hardened	350	33							
		cast	320	34								
Titanium alloys	pure titanium	R_m 400	35									
	α and β alloys	hardened	R_m 1050	36								
H	Hardened steel	hardened and tempered		55 HRC	37							
		hardened and tempered		60 HRC	38							
	Hard cast iron	cast		400	39							
	Hardened cast iron	hardened and tempered		55 HRC	40							
X	Non-metallic materials	Thermoplasts			41							
		Thermosetting plastics			42							
		Plastic, glass-fibre reinforced GFRP			43							
		Plastic, carbon fibre reinforced CFRP			44							
		Graphite			45							
		Wood			46							

Note: The given cutting values are guide values, which were determined under ideal conditions.
 The values have to be adapted in individual cases.
 Feed rate recommendations on page B254.
 For examples of material for cutting tool groups view page D11.

Indexable milling – group 4 (BMR01/02/03/04, TMP01, CMZ01, CMA01, CMD01)

	Material group	Composition / structure / heat treatment		Brinell hardness HB	Machining group	Starting values for cutting speed v_c [m/min]					
						HC (CVD)					
						YBC302			YBC401		
						a_e / D			a_e / D		
	1/1 3/4	1/5	1/20	1/1 3/4	1/5	1/20					
P	Unalloyed steel	approx. 0,15 % C	annealed	125	1	235	275	360	200	230	300
		approx. 0,45 % C	annealed	190	2	200	235	310	170	200	260
		approx. 0,45 % C	tempered	250	3	190	220	290	160	185	245
		approx. 0,75 % C	annealed	270	4	165	195	255	140	165	215
		approx. 0,75 % C	tempered	300	5	155	180	235	130	150	195
	Low-alloyed steel		annealed	180	6	200	235	310	170	200	260
			tempered	275	7	165	195	255	140	165	215
			tempered	300	8	155	180	235	130	150	195
		tempered	350	9	130	155	205	110	130	170	
High-alloyed steel and high-alloyed tool steel		annealed	200	10	120	140	185	100	115	150	
		hardened and tempered	325	11	85	100	130	70	85	115	
M	Stainless steel	ferritic/martensitic	annealed	200	12						
			martensitic	tempered	240	13					
			austenitic	quench hardened	180	14					
			austenitic-ferritic		230	15					
K	Grey cast iron	perlitic/ferritic		180	16						
			perlitic (martensitic)		260	17					
	Cast iron with spheroidal graphite	ferritic		160	18						
			perlitic		250	19					
	Malleable cast iron	ferritic		130	20						
			perlitic		230	21					
N	Aluminium wrought alloys	cannot be hardened		60	22						
		hardenable	hardened	100	23						
	Cast aluminium alloys	$\leq 12\% \text{ Si}$, cannot be hardened		75	24						
		$\leq 12\% \text{ Si}$, hardenable	hardened	90	25						
		$> 12\% \text{ Si}$, cannot be hardened		130	26						
	Copper and copper alloys (bronze/brass)	machining steel, PB > 1%		110	27						
		CuZn, CuSnZn		90	28						
CuSn, Pb-free copper, electrolytic copper		100	29								
S	Heat-resistant alloys	Fe-based alloys	annealed	200	30						
			hardened	280	31						
		Ni or Co base	annealed	250	32						
			hardened	350	33						
		cast	320	34							
Titanium alloys	pure titanium		R_m 400	35							
	α and β alloys	hardened		R_m 1050	36						
H	Hardened steel		hardened and tempered	55 HRC	37						
			hardened and tempered	60 HRC	38						
	Hard cast iron		cast	400	39						
	Hardened cast iron		hardened and tempered	55 HRC	40						
X	Non-metallic materials	Thermoplasts			41						
		Thermosetting plastics			42						
		Plastic, glass-fibre reinforced GFRP			43						
		Plastic, carbon fibre reinforced CFRP			44						
		Graphite			45						
		Wood			46						

Note: The given cutting values are guide values, which were determined under ideal conditions.
 The values have to be adapted in individual cases.
 Feed rate recommendations on page B254.
 For examples of material for cutting tool groups view page D11.

Starting values for cutting speed v_c [m/min]																						
HC (CVD)									HC (PVD)													
YBD152			YBD252			YBM253			YBG102			YBG152			YB9320			YBG205				
a_e / D			a_e / D			a_e / D			a_e / D			a_e / D			a_e / D			a_e / D				
1/1 3/4	1/5	1/20	1/1 3/4	1/5	1/20	1/1 3/4	1/5	1/20	1/1 3/4	1/5	1/20	1/1 3/4	1/5	1/20	1/1 3/4	1/5	1/20	1/1 3/4	1/5	1/20		
								235	275	360	245	285	375	230	265	345	220	255	335	210	245	320
								200	235	310	210	245	320	200	230	300	190	220	290	180	210	275
								190	220	290	200	230	300	185	215	280	180	205	270	170	200	260
								165	195	255	175	200	260	165	190	250	155	180	235	150	175	230
								155	180	235	160	190	250	150	175	230	145	170	225	140	160	210
								200	235	310	210	245	320	200	230	300	190	220	290	180	210	275
								165	195	255	175	200	260	165	190	250	155	180	235	150	175	230
								155	180	235	160	190	250	150	175	230	145	170	225	140	160	210
								130	155	205	135	160	210	130	150	195	125	145	190	120	135	180
								120	140	185	125	145	190	115	135	180	110	130	170	105	125	165
								85	100	130	90	100	130	85	95	125	80	90	120	75	90	120
								120	140	180	125	145	190	115	135	175	110	130	170	105	125	160
								100	120	155	105	120	160	100	115	145	95	110	145	90	105	135
								125	150	195	130	155	200	125	145	185	120	140	180	115	130	170
								100	120	155	105	120	160	100	115	145	95	110	145	90	105	135
	300	345	450	260	300	390					270	315	410	255	295	385	245	285	375	235	275	360
	180	210	275	155	180	235					160	190	250	150	175	230	145	170	225	140	160	210
	210	245	320	180	210	275					185	215	280	175	200	260	165	195	255	160	185	245
	140	165	215	120	140	185					125	145	190	115	135	180	110	130	170	105	125	165
	250	290	380	215	250	325					225	260	340	210	240	315	200	230	300	190	225	295
	170	200	260	145	165	215					150	175	230	140	160	210	135	155	205	130	150	195

HC Coated carbide
 HT Uncoated carbide, main component (TiC) o. (TiN), cermet
 HC₁ Coated cermet
 HW Uncoated carbide, main component (WC)

A
Turning
B
Milling
C
Drilling
D
Technical Information
E
Index



Indexable milling – group 4 (BMR01/02/03/04, TMP01, CMZ01, CMA01, CMD01)

	Material group	Composition / structure / heat treatment		Brinell hardness HB	Machining group	Starting values for cutting speed v_c [m/min]							
						HC (PVD)							
						YBG212			YBG252				
						a_e / D			a_e / D				
1/1 3/4	1/5	1/20	1/1 3/4	1/5	1/20								
P	Unalloyed steel	approx. 0,15 % C	annealed	125	1	215	250	325	205	240	315		
		approx. 0,45 % C	annealed	190	2	185	215	280	175	205	270		
		approx. 0,45 % C	tempered	250	3	175	200	260	165	195	255		
		approx. 0,75 % C	annealed	270	4	155	175	230	145	170	225		
		approx. 0,75 % C	tempered	300	5	140	165	215	135	160	210		
	Low-alloyed steel		annealed	180	6	185	215	280	175	205	270		
			tempered	275	7	155	175	230	145	170	225		
			tempered	300	8	140	165	215	135	160	210		
			tempered	350	9	120	140	185	115	135	180		
	High-alloyed steel and high-alloyed tool steel		annealed	200	10	110	125	165	105	120	160		
		hardened and tempered	325	11	80	90	120	75	85	115			
M	Stainless steel	ferritic/martensitic	annealed	200	12	110	125	165	105	120	160		
			martensitic	tempered	240	13	95	105	140	90	105	135	
			austenitic	quench hardened	180	14	115	135	175	110	130	170	
			austenitic-ferritic		230	15	95	105	140	90	105	135	
K	Grey cast iron	perlite/ferritic		180	16	240	280	365	230	265	345		
			perlite (martensitic)		260	17	140	165	215	135	160	210	
	Cast iron with spheroidal graphite	ferritic		160	18	165	190	250	155	180	235		
			perlite		250	19	110	125	165	105	120	160	
Malleable cast iron	ferritic		130	20	195	225	295	185	220	290			
		perlite		230	21	130	150	195	125	145	190		
N	Aluminium wrought alloys	cannot be hardened		60	22								
		hardenable	hardened	100	23								
	Cast aluminium alloys	$\leq 12\% \text{ Si}$, cannot be hardened		75	24								
		$\leq 12\% \text{ Si}$, hardenable	hardened	90	25								
		$> 12\% \text{ Si}$, cannot be hardened		130	26								
	Copper and copper alloys (bronze/brass)	machining steel, PB > 1%		110	27								
		CuZn, CuSnZn		90	28								
CuSn, Pb-free copper, electrolytic copper		100	29										
S	Heat-resistant alloys	Fe-based alloys	annealed	200	30								
			hardened	280	31								
		Ni or Co base	annealed	250	32								
			hardened	350	33								
		cast	320	34									
Titanium alloys	pure titanium	R_m 400	35										
	α and β alloys	hardened	R_m 1050	36									
H	Hardened steel		hardened and tempered	55 HRC	37								
			hardened and tempered	60 HRC	38								
	Hard cast iron		cast	400	39								
	Hardened cast iron		hardened and tempered	55 HRC	40								
X	Non-metallic materials	Thermoplasts			41								
		Thermosetting plastics			42								
		Plastic, glass-fibre reinforced GFRP			43								
		Plastic, carbon fibre reinforced CFRP			44								
		Graphite			45								
		Wood			46								

Note: The given cutting values are guide values, which were determined under ideal conditions.
 The values have to be adapted in individual cases.
 Feed rate recommendations on page B254.
 For examples of material for cutting tool groups view page D11.

Indexable milling – group 5 (SMP01/03/05)

	Material group	Composition / structure / heat treatment		Brinell hardness HB	Machining group	Starting values for cutting speed v_c [m/min]			
						HC (CVD)		HC (PVD)	
						YBC302	YBM253	YBG101	YB9320
		a_e / D	a_e / D	a_e / D	a_e / D				
		1/4	1/4	1/4	1/4				
P	Unalloyed steel	approx. 0,15 % C	annealed	125	1	165	180	190	175
		approx. 0,45 % C	annealed	190	2	145	155	165	150
		approx. 0,45 % C	tempered	250	3	135	145	155	140
		approx. 0,75 % C	annealed	270	4	120	130	135	125
		approx. 0,75 % C	tempered	300	5	110	120	125	115
P	Low-alloyed steel		annealed	180	6	145	155	165	150
			tempered	275	7	120	130	135	125
			tempered	300	8	110	120	125	115
			tempered	350	9	95	100	105	100
P	High-alloyed steel and high-alloyed tool steel		annealed	200	10	85	90	95	90
			hardened and tempered	325	11	60	65	70	65
M	Stainless steel	ferritic/martensitic	annealed	200	12		90	95	90
		martensitic	tempered	240	13		80	80	75
		austenitic	quench hardened	180	14		100	105	95
		austenitic-ferritic		230	15		80	80	75
K	Grey cast iron	perlitic/ferritic		180	16			215	190
		perlitic (martensitic)		260	17			125	115
	Cast iron with spheroidal graphite	ferritic		160	18			145	135
		perlitic		250	19			95	90
K	Malleable cast iron	ferritic		130	20			175	160
		perlitic		230	21			115	105
N	Aluminium wrought alloys	cannot be hardened		60	22				
		hardenable	hardened	100	23				
	Cast aluminium alloys	$\leq 12\% \text{ Si}$, cannot be hardened		75	24				
		$\leq 12\% \text{ Si}$, hardenable	hardened	90	25				
		$> 12\% \text{ Si}$, cannot be hardened		130	26				
	Copper and copper alloys (bronze/brass)	machining steel, PB > 1%		110	27				
CuZn, CuSnZn		90	28						
S	Heat-resistant alloys	Fe-based alloys	annealed	200	30				
			hardened	280	31				
		Ni or Co base	annealed	250	32				
			hardened	350	33				
		cast	320	34					
Titanium alloys	pure titanium		R_m 400	35					
	α and β alloys	hardened	R_m 1050	36					
H	Hardened steel		hardened and tempered	55 HRC	37				
			hardened and tempered	60 HRC	38				
	Hard cast iron		cast	400	39				
	Hardened cast iron		hardened and tempered	55 HRC	40				
X	Non-metallic materials	Thermoplasts			41				
		Thermosetting plastics			42				
		Plastic, glass-fibre reinforced GFRP			43				
		Plastic, carbon fibre reinforced CFRP			44				
		Graphite			45				
		Wood			46				

Note: The given cutting values are guide values, which were determined under ideal conditions.
 The values have to be adapted in individual cases.
 Feed rate recommendations on page B254.
 For examples of material for cutting tool groups view page D11.

Indexable milling – group 6 (FMD03, FME04, FMP03, HMP01)

	Material group	Composition / structure / heat treatment		Brinell hardness HB	Machining group	Starting values for cutting speed v_c [m/min]								
						HC (CVD)								
						YBC302		YBC401		YBD152		YBD252		
						a_e / D		a_e / D		a_e / D		a_e / D		
						1/1 3/4	1/5	1/1 3/4	1/5	1/1 3/4	1/5	1/1 3/4	1/5	
P	Unalloyed steel	approx. 0,15 % C	annealed	125	1	200	230	170	200					
		approx. 0,45 % C	annealed	190	2	170	200	145	170					
		approx. 0,45 % C	tempered	250	3	160	185	140	160					
		approx. 0,75 % C	annealed	270	4	140	165	120	140					
		approx. 0,75 % C	tempered	300	5	130	150	115	130					
P	Low-alloyed steel		annealed	180	6	170	200	145	170					
			tempered	275	7	140	165	120	140					
			tempered	300	8	130	150	115	130					
			tempered	350	9	110	130	95	110					
P	High-alloyed steel and high-alloyed tool steel		annealed	200	10	100	115	85	100					
			hardened and tempered	325	11	70	85	60	70					
M	Stainless steel	ferritic/martensitic	annealed	200	12									
			martensitic	tempered	240	13								
			austenitic	quench hardened	180	14								
			austenitic-ferritic		230	15								
K	Grey cast iron	perlitic/ferritic		180	16				255	295	220	255		
		perlitic (martensitic)		260	17				150	175	130	150		
	Cast iron with spheroidal graphite	ferritic		160	18				175	205	150	175		
		perlitic		250	19				115	135	100	115		
K	Malleable cast iron	ferritic		130	20				210	245	180	210		
		perlitic		230	21				140	165	120	140		
N	Aluminium wrought alloys	cannot be hardened		60	22									
		hardenable	hardened	100	23									
	Cast aluminium alloys	$\leq 12\% \text{ Si}$, cannot be hardened		75	24									
		$\leq 12\% \text{ Si}$, hardenable	hardened	90	25									
		$> 12\% \text{ Si}$, cannot be hardened		130	26									
	Copper and copper alloys (bronze/brass)	machining steel, PB > 1%		110	27									
CuZn, CuSnZn		90	28											
S	Heat-resistant alloys	Fe-based alloys	annealed	200	30									
			hardened	280	31									
		Ni or Co base	annealed	250	32									
			hardened	350	33									
		cast	320	34										
Titanium alloys	pure titanium		R_m 400	35										
	α and β alloys	hardened		R_m 1050	36									
H	Hardened steel		hardened and tempered	55 HRC	37									
			hardened and tempered	60 HRC	38									
	Hard cast iron		cast	400	39									
	Hardened cast iron		hardened and tempered	55 HRC	40									
X	Non-metallic materials	Thermoplasts			41									
		Thermosetting plastics			42									
		Plastic, glass-fibre reinforced GFRP			43									
		Plastic, carbon fibre reinforced CFRP			44									
		Graphite			45									
	Wood		46											

Note: The given cutting values are guide values, which were determined under ideal conditions.
 The values have to be adapted in individual cases.
 Feed rate recommendations on page B254.
 For examples of material for cutting tool groups view page D11.

Starting values for cutting speed v_c [m/min]																
HC (CVD)		HC (PVD)														
YBM253		YBG102		YBG152		YB9320		YBG205		YBG212		YBG252		YBG302		
a_e / D		a_e / D		a_e / D		a_e / D		a_e / D		a_e / D		a_e / D		a_e / D		
1/1 3/4	1/5	1/1 3/4	1/5	1/1 3/4	1/5	1/1 3/4	1/5	1/1 3/4	1/5	1/1 3/4	1/5	1/1 3/4	1/5	1/1 3/4	1/5	
200	230	205	240	195	225	190	220	185	215	185	215	180	210	175	205	
170	200	175	205	170	195	165	190	160	185	160	185	155	180	150	175	
160	185	165	195	160	180	155	180	150	175	150	175	145	170	140	165	
140	165	145	170	140	160	135	155	130	155	130	155	130	150	125	145	
130	150	135	160	130	150	125	145	125	140	125	140	120	140	115	135	
170	200	175	205	170	195	165	190	160	185	160	185	155	180	150	175	
140	165	145	170	140	160	135	155	130	155	130	155	130	150	125	145	
130	150	135	160	130	150	125	145	125	140	125	140	120	140	115	135	
170	200	175	205	170	195	165	190	160	185	160	185	155	180	150	175	
140	165	145	170	140	160	135	155	130	155	130	155	130	150	125	145	
130	150	135	160	130	150	125	145	125	140	125	140	120	140	115	135	
110	130	115	135	110	125	105	125	105	120	105	120	100	120	100	115	
100	115	105	120	100	115	95	110	95	110	95	110	90	105	90	105	
70	85	75	85	70	80	70	80	65	80	65	80	65	75	65	75	
100	115	105	120	100	115	95	110	95	110	95	110	90	105	90	105	
85	100	90	105	85	95	80	95	80	95	80	95	80	90	75	90	
110	125	110	130	105	120	105	120	100	115	100	115	100	115	95	110	
85	100	90	105	85	95	80	95	80	95	80	95	80	90	75	90	
		230	265	215	250	210	245	205	240	205	240	200	230	195	225	
		135	160	130	150	125	145	125	140	125	140	120	140	115	135	
		155	180	150	170	145	165	140	165	140	165	135	160	135	155	
		105	120	100	115	95	110	95	110	95	110	90	105	90	105	
		185	220	180	205	175	200	170	195	170	195	165	190	160	185	
		125	145	120	135	115	135	115	130	115	130	110	130	105	125	

HC Coated carbide
 HT Uncoated carbide, main component (TiC) o. (TiN), cermet
 HC₁ Coated cermet
 HW Uncoated carbide, main component (WC)

A
Turning
B
Milling
C
Drilling
D
Technical Information
E
Index



Indexable milling – group 7 (XMR01, XMP01)

	Material group	Composition / structure / heat treatment		Brinell hardness HB	Machining group	Starting values for cutting speed v_c [m/min]							
						HC (CVD)							
						YBC302			YBD152				
						a_e / D			a_e / D				
1/1 3/4	1/5	1/20	1/1 3/4	1/5	1/20								
P	Unalloyed steel	approx. 0,15 % C	annealed	125	1	260	300	390					
		approx. 0,45 % C	annealed	190	2	225	255	335					
		approx. 0,45 % C	tempered	250	3	210	240	315					
		approx. 0,75 % C	annealed	270	4	185	210	275					
		approx. 0,75 % C	tempered	300	5	170	195	255					
	Low-alloyed steel		annealed	180	6	225	255	335					
			tempered	275	7	185	210	275					
			tempered	300	8	170	195	255					
		tempered	350	9	145	165	215						
High-alloyed steel and high-alloyed tool steel		annealed	200	10	130	150	195						
		hardened and tempered	325	11	95	105	140						
M	Stainless steel	ferritic/martensitic	annealed	200	12								
			martensitic	tempered	240	13							
			austenitic	quench hardened	180	14							
			austenitic-ferritic		230	15							
K	Grey cast iron	perlitic/ferritic		180	16				335	390	510		
			perlitic (martensitic)		260	17			200	230	300		
	Cast iron with spheroidal graphite	ferritic		160	18				225	260	340		
			perlitic		250	19			150	175	230		
	Malleable cast iron	ferritic		130	20				275	320	420		
			perlitic		230	21			185	215	280		
N	Aluminium wrought alloys	cannot be hardened		60	22								
		hardenable	hardened	100	23								
	Cast aluminium alloys	$\leq 12\% \text{ Si}$, cannot be hardened			75	24							
		$\leq 12\% \text{ Si}$, hardenable	hardened		90	25							
		$> 12\% \text{ Si}$, cannot be hardened			130	26							
	Copper and copper alloys (bronze/brass)	machining steel, PB > 1%			110	27							
		CuZn, CuSnZn			90	28							
		CuSn, Pb-free copper, electrolytic copper			100	29							
S	Heat-resistant alloys	Fe-based alloys	annealed	200	30								
			hardened	280	31								
		Ni or Co base	annealed	250	32								
			hardened	350	33								
		cast	320	34									
Titanium alloys	pure titanium		R_m 400	35									
	α and β alloys	hardened		R_m 1050	36								
H	Hardened steel		hardened and tempered	55 HRC	37								
			hardened and tempered	60 HRC	38								
	Hard cast iron		cast	400	39								
	Hardened cast iron		hardened and tempered	55 HRC	40								
X	Non-metallic materials	Thermoplasts			41								
		Thermosetting plastics			42								
		Plastic, glass-fibre reinforced GFRP			43								
		Plastic, carbon fibre reinforced CFRP			44								
		Graphite			45								
		Wood			46								

Note: The given cutting values are guide values, which were determined under ideal conditions.
 The values have to be adapted in individual cases.
 Feed rate recommendations on page B254.
 For examples of material for cutting tool groups view page D11.

Indexable milling – group 7 (XMR01, XMP01)

	Material group	Composition / structure / heat treatment		Brinell hardness HB	Machining group	Starting values for cutting speed v_c [m/min]						
						HC (PVD)						
						YBG252			YBG302			
						a_e / D		a_e / D		a_e / D		
	1/1 3/4	1/5	1/20	1/1 3/4	1/5	1/20						
P	Unalloyed steel	approx. 0,15 % C	annealed	125	1	230	265	345	225	260	340	
		approx. 0,45 % C	annealed	190	2	200	230	300	195	225	295	
		approx. 0,45 % C	tempered	250	3	185	215	280	180	210	275	
		approx. 0,75 % C	annealed	270	4	165	190	250	160	185	245	
		approx. 0,75 % C	tempered	300	5	150	175	230	150	170	225	
	Low-alloyed steel		annealed	180	6	200	230	300	195	225	295	
			tempered	275	7	165	190	250	160	185	245	
			tempered	300	8	150	175	230	150	170	225	
		tempered	350	9	130	150	195	125	145	190		
High-alloyed steel and high-alloyed tool steel		annealed	200	10	115	135	180	115	130	170		
		hardened and tempered	325	11	85	95	125	80	95	125		
M	Stainless steel	ferritic/martensitic	annealed	200	12	115	135	175	115	130	170	
			martensitic	tempered	240	13	100	115	145	95	110	145
			austenitic	quench hardened	180	14	125	145	185	120	140	185
			austenitic-ferritic		230	15	100	115	145	95	110	145
K	Grey cast iron	perlite/ferritic		180	16	255	295	385	250	290	380	
		perlite (martensitic)		260	17	150	175	230	150	170	225	
	Cast iron with spheroidal graphite	ferritic		160	18	175	200	260	170	195	255	
		perlite		250	19	115	135	180	115	130	170	
Malleable cast iron	ferritic		130	20	210	240	315	205	235	310		
	perlite		230	21	140	160	210	135	160	210		
N	Aluminium wrought alloys	cannot be hardened		60	22							
		hardenable	hardened	100	23							
	Cast aluminium alloys	$\leq 12\% \text{ Si}$, cannot be hardened		75	24							
		$\leq 12\% \text{ Si}$, hardenable	hardened	90	25							
		$> 12\% \text{ Si}$, cannot be hardened		130	26							
	Copper and copper alloys (bronze/brass)	machining steel, PB > 1%		110	27							
CuZn, CuSnZn		90	28									
CuSn, Pb-free copper, electrolytic copper		100	29									
S	Heat-resistant alloys	Fe-based alloys	annealed	200	30							
			hardened	280	31							
		Ni or Co base	annealed	250	32							
			hardened	350	33							
		cast	320	34								
Titanium alloys	pure titanium		R_m 400	35								
	α and β alloys	hardened	R_m 1050	36								
H	Hardened steel		hardened and tempered	55 HRC	37							
			hardened and tempered	60 HRC	38							
	Hard cast iron		cast	400	39							
	Hardened cast iron		hardened and tempered	55 HRC	40							
X	Non-metallic materials	Thermoplasts			41							
		Thermosetting plastics			42							
		Plastic, glass-fibre reinforced GFRP			43							
		Plastic, carbon fibre reinforced CFRP			44							
		Graphite			45							
		Wood			46							

Note: The given cutting values are guide values, which were determined under ideal conditions.
 The values have to be adapted in individual cases.
 Feed rate recommendations on page B254.
 For examples of material for cutting tool groups view page D11.

Recommended feed rate

Indexable milling – group1 (FMA07/11/12, FMD02, EMP09/13)

Material group	Feed rate per cutting edge [mm]																			
	EMP09			EMP09			EMP13			EMP13			FMA07			FMA07				
	LNKT08/12			LNKT16			ANGX11			ANGX15			ONHU06			ONHU08				
	Application																			
	F	M	R	F	M	R	F	M	R	F	M	R	F	M	R	F	M	R		
P Unalloyed steel		0,25	0,50		0,28	0,55		0,23			0,25		0,19	0,23		0,19	0,23			
	Low-alloyed steel		0,23	0,47		0,26	0,51		0,22			0,23		0,17	0,22		0,17	0,22		
	High-alloyed steel and high-alloyed tool steel		0,22	0,44		0,24	0,48		0,20			0,22		0,16	0,20		0,16	0,20		
M Stainless steel		0,18	0,35		0,19	0,39		0,16			0,18									
K Grey cast iron		0,28	0,55		0,30	0,61		0,26			0,28		0,20	0,26		0,20	0,26			
	Cast iron with spheroidal graphite		0,25	0,50		0,28	0,55		0,23			0,25		0,19	0,23		0,19	0,23		
	Malleable cast iron		0,25	0,50		0,28	0,55		0,23			0,25		0,19	0,23		0,19	0,23		
N Aluminum wrought alloys								0,20			0,21									
	Aluminum cast alloys								0,20			0,21								
	Copper and copper alloys (bronze/brass)								0,18			0,19								
S Heat-resistant alloys																				
	Titanium alloys																			
H Hardened steel																				
	Hard cast iron																			
	Hardened cast iron																			
X Non-metallic materials																				

Note: The given cutting values are guide values, which were determined under ideal conditions.
The values have to be adapted in individual cases.

Indexable milling – group1 (FMA07/11/12, FMD02, EMP09/13)

Material group	Feed rate per cutting edge [mm]																		
	FMP12																		
	WNHU08																		
	Application																		
	F	M	R																
P Unalloyed steel		0,25																	
	Low-alloyed steel		0,23																
	High-alloyed steel and high-alloyed tool steel		0,22																
M Stainless steel		0,18																	
K Grey cast iron		0,28																	
	Cast iron with spheroidal graphite		0,25																
	Malleable cast iron		0,25																
N Aluminium wrought alloys																			
	Aluminum cast alloys																		
	Copper and copper alloys (bronze/brass)																		
S Heat-resistant alloys																			
	Titanium alloys																		
H Hardened steel																			
	Hard cast iron																		
	Hardened cast iron																		
X Non-metallic materials																			

Note: The given cutting values are guide values, which were determined under ideal conditions.
The values have to be adapted in individual cases.

Recommended feed rate

Indexable milling – group 2 (FMA01/02/03/04, FME01/02, FMP01/02, EMP01/02/03/04)

Material group		Feed rate per cutting edge [mm]																	
		FMA01 FMA02			FMA03			FMA03			FMA04			FMA04			FMA04		
		SEET12			SEKN12			SEKN15			OFKT05			OFKR07			ODHT06		
		Application																	
		F	M	R	F	M	R	F	M	R	F	M	R	F	M	R	F	M	R
P	Unalloyed steel	0,15	0,20	0,25		0,18			0,20		0,20	0,25		0,20	0,25		0,20	0,25	
	Low-alloyed steel	0,14	0,19	0,23		0,17			0,19		0,19	0,23		0,19	0,23		0,19	0,23	
	High-alloyed steel and high-alloyed tool steel	0,13	0,18	0,22		0,16			0,18		0,18	0,22		0,18	0,22		0,18	0,22	
M	Stainless steel	0,11	0,14	0,18		0,13			0,14		0,14	0,18		0,14	0,18		0,14	0,18	
K	Grey cast iron	0,17	0,22	0,28		0,20			0,22		0,22	0,28		0,22	0,28		0,22	0,28	
	Cast iron with spheroidal graphite	0,15	0,20	0,25		0,18			0,20		0,20	0,25		0,20	0,25		0,20	0,25	
	Malleable cast iron	0,15	0,20	0,25		0,18			0,20		0,20	0,25		0,20	0,25		0,20	0,25	
N	Aluminium wrought alloys	0,13	0,17	0,21							0,17	0,21		0,17	0,21		0,17	0,21	
	Aluminum cast alloys	0,13	0,17	0,21							0,17	0,21		0,17	0,21		0,17	0,21	
	Copper and copper alloys (bronze/brass)	0,11	0,15	0,19							0,15	0,19		0,15	0,19		0,15	0,19	
S	Heat-resistant alloys	0,11	0,14	0,18							0,14	0,18		0,14	0,18		0,14	0,18	
	Titanium alloys	0,11	0,14	0,18							0,14	0,18		0,14	0,18		0,14	0,18	
H	Hardened steel																		
	Hard cast iron																		
	Hardened cast iron																		
X	Non-metallic materials																		

Note: The given cutting values are guide values, which were determined under ideal conditions. The values have to be adapted in individual cases.

Indexable milling – group 3 (FMR01/02/03/04) Face milling

Material group		Feed rate per cutting edge [mm]																	
		FMR01			FMR01			FMR02			FMR02			FMR02			FMR03		
		RCKT10			RC*12			RC*12			RCKT16			RCKT20			RDKW07		
		Application																	
		F	M	R	F	M	R	F	M	R	F	M	R	F	M	R	F	M	R
P	Unalloyed steel		0,20	0,25		0,20	0,25		0,20	0,25		0,23	0,29		0,26	0,33		0,17	
	Low-alloyed steel		0,19	0,23		0,19	0,23		0,19	0,23		0,21	0,27		0,25	0,31		0,16	
	High-alloyed steel and high-alloyed tool steel		0,18	0,22		0,18	0,22		0,18	0,22		0,20	0,25		0,23	0,29		0,15	
M	Stainless steel		0,14	0,18		0,14	0,18		0,14	0,18		0,16	0,20		0,19	0,23		0,12	
K	Grey cast iron		0,22	0,28		0,22	0,28		0,22	0,28		0,25	0,32		0,29	0,36		0,19	
	Cast iron with spheroidal graphite		0,20	0,25		0,20	0,25		0,20	0,25		0,23	0,29		0,26	0,33		0,17	
	Malleable cast iron		0,20	0,25		0,20	0,25		0,20	0,25		0,23	0,29		0,26	0,33		0,17	
N	Aluminium wrought alloys					0,17	0,21		0,17	0,21									
	Aluminum cast alloys					0,17	0,21		0,17	0,21									
	Copper and copper alloys (bronze/brass)					0,15	0,19		0,15	0,19									
S	Heat-resistant alloys																		
	Titanium alloys																		
H	Hardened steel																		
	Hard cast iron																		
	Hardened cast iron																		
X	Non-metallic materials																		

Note: The given cutting values are guide values, which were determined under ideal conditions. The values have to be adapted in individual cases.

Feed rate per cutting edge [mm]																							
FME02			FME03			FME03			FMP01			FMP02			EMP01 EMP02			EMP01 EMP02			EMP03 EMP04		
SPK*12			SPK*12			SPK*15			TPKN22			SEET12			APKT11			APKT16			APKT11		
Application																							
F	M	R	F	M	R	F	M	R	F	M	R	F	M	R	F	M	R	F	M	R	F	M	R
	0,20			0,19			0,20			0,20		0,15	0,20	0,25	0,10	0,15	0,20	0,12	0,17	0,23	0,10	0,20	0,25
	0,19			0,17			0,19			0,19		0,14	0,19	0,23	0,09	0,14	0,19	0,11	0,16	0,21	0,09	0,19	0,23
	0,18			0,16			0,18			0,18		0,13	0,18	0,22	0,09	0,13	0,18	0,10	0,15	0,20	0,09	0,18	0,22
	0,14			0,13			0,14			0,14		0,11	0,14	0,18	0,07	0,11	0,14	0,08	0,12	0,16	0,07	0,14	0,18
	0,22			0,20			0,22			0,22		0,17	0,22	0,28	0,11	0,17	0,22	0,13	0,19	0,25	0,11	0,22	0,28
	0,20			0,19			0,20			0,20		0,15	0,20	0,25	0,10	0,15	0,20	0,12	0,17	0,23	0,10	0,20	0,25
	0,20			0,19			0,20			0,20		0,15	0,20	0,25	0,10	0,15	0,20	0,12	0,17	0,23	0,10	0,20	0,25
												0,13	0,17	0,21	0,09	0,13	0,17	0,10	0,15	0,20	0,09	0,17	0,21
												0,13	0,17	0,21	0,09	0,13	0,17	0,10	0,15	0,20	0,09	0,17	0,21
												0,11	0,15	0,19	0,08	0,11	0,15	0,09	0,13	0,18	0,08	0,15	0,19

F Finishing
M Medium machining
R Roughing

Feed rate per cutting edge [mm]														
FMR03			FMR03			FMR04			FMR04			FMR04		
RDKW08			RD*10			RD*12			RDKW16			RDKW20		
Application														
F	M	R	F	M	R	F	M	R	F	M	R	F	M	R
	0,17			0,20		0,15	0,20	0,25	0,17	0,23	0,29	0,2	0,26	0,33
	0,16			0,19		0,14	0,19	0,23	0,16	0,21	0,27	0,19	0,25	0,31
	0,15			0,18		0,13	0,18	0,22	0,15	0,20	0,25	0,18	0,23	0,29
	0,12			0,14		0,11	0,14	0,18	0,12	0,16	0,20	0,14	0,19	0,23
	0,19			0,22		0,17	0,22	0,28	0,19	0,25	0,32	0,22	0,29	0,36
	0,17			0,20		0,15	0,20	0,25	0,17	0,23	0,29	0,20	0,26	0,33
	0,17			0,20		0,15	0,20	0,25	0,17	0,23	0,29	0,20	0,26	0,33
				0,17		0,13	0,17	0,21						
				0,17		0,13	0,17	0,21						
				0,15		0,11	0,15	0,19						

F Finishing
M Medium machining
R Roughing

A

Turning

B

Milling

C

Drilling

D

Technical Information

E

Index



Recommended feed rate

Indexable milling – group 3 (FMR01/02/03/04) Circular milling

Material group	Feed rate per cutting edge [mm]								
	FMR01	FMR01	FMR02	FMR02	FMR02	FMR03			
	RCKT10	RC*12	RC*12	RCKT16	RCKT20	RDKW07			
	Tool diameter [mm]								
	25-32	40-50	50-100	63-125	160-200	80-125	160-250	15	
P	Unalloyed steel	0,12	0,16	0,18	0,24	0,32	0,26	0,35	0,07
	Low-alloyed steel	0,11	0,14	0,16	0,21	0,28	0,23	0,31	0,06
	High-alloyed steel and high-alloyed tool steel	0,10	0,13	0,14	0,19	0,26	0,21	0,28	0,06
M	Stainless steel	0,07	0,09	0,10	0,14	0,18	0,15	0,20	0,04
K	Grey cast iron	0,11	0,14	0,16	0,22	0,29	0,23	0,32	0,06
	Cast iron with spheroidal graphite	0,10	0,13	0,14	0,19	0,26	0,21	0,28	0,06
	Malleable cast iron	0,10	0,13	0,14	0,19	0,26	0,21	0,28	0,06
N	Aluminium wrought alloys								
	Aluminum cast alloys								
	Copper and copper alloys (bronze/brass)								
S	Heat-resistant alloys								
	Titanium alloys								
H	Hardened steel								
	Hard cast iron								
	Hardened cast iron								
X	Non-metallic materials								

Note: The given cutting values are guide values, which were determined under ideal conditions.
The values have to be adapted in individual cases.

Indexable milling – group 4 (BMR01/02/03/04, TMP01, CMZ01, CMA01, CMD01)

Material group	Feed rate per cutting edge [mm]									
	BMR01	BMR01	BMR01	BMR01	BMR02	BMR02	BMR02	BMR03	BMR03	
	ZD*08 / SP*06	ZD*11 / SP*06	ZD*13 / SP*09	ZP*22 / SP*12	ROHX12	ROHX16	ROHX20	-	-	
	Tool diameter [mm]									
	20	25	32	40-63	12	16	20	16	20	
P	Unalloyed steel	0,14	0,21	0,26	0,32	0,10	0,13	0,14	0,13	0,14
	Low-alloyed steel	0,10	0,15	0,18	0,22	0,07	0,09	0,10	0,09	0,10
	High-alloyed steel and high-alloyed tool steel	0,09	0,14	0,17	0,21	0,07	0,08	0,09	0,08	0,09
M	Stainless steel	0,08	0,12	0,14	0,18	0,06	0,07	0,08	0,07	0,08
K	Grey cast iron	0,18	0,27	0,34	0,42	0,13	0,17	0,18	0,17	0,18
	Cast iron with spheroidal graphite	0,13	0,20	0,25	0,30	0,10	0,12	0,13	0,12	0,13
	Malleable cast iron	0,14	0,21	0,26	0,32	0,10	0,13	0,14	0,13	0,14
N	Aluminum wrought alloys									
	Aluminum cast alloys									
	Copper and copper alloys (bronze/brass)									
S	Heat-resistant alloys									
	Titanium alloys									
H	Hardened steel									
	Hard cast iron									
	Hardened cast iron									
X	Non-metallic materials									

Note: The given cutting values are guide values, which were determined under ideal conditions.
The values have to be adapted in individual cases.

Recommended feed rate

Indexable milling – group 5 (SMP01/03/05)

Material group	Feed rate per cutting edge [mm]									
	SMP01	SMP01	SMP01	SMP01	SMP01	SMP03	SMP03	SMP03	SMP05	
	XSEQ1202	XSEQ1203	XSEQ12T3	XSEQ1204	XSEQ12T4	MPHT06	MPHT08	MPHT12	QC16	
	Tool diameter [mm]									
	63-100	63-100	63-160	63-160	63-160	80-125	125-200	120-200	25-39	
P	Unalloyed steel	0,12	0,12	0,13	0,13	0,14	0,14	0,15	0,16	0,08
	Low-alloyed steel	0,11	0,11	0,12	0,12	0,13	0,13	0,14	0,15	0,08
	High-alloyed steel and high-alloyed tool steel	0,10	0,10	0,11	0,11	0,12	0,12	0,13	0,14	0,07
M	Stainless steel	0,10	0,10	0,11	0,11	0,12	0,12	0,13	0,14	0,07
K	Grey cast iron	0,11	0,11	0,12	0,12	0,13	0,13	0,14	0,15	0,08
	Cast iron with spheroidal graphite	0,11	0,11	0,12	0,12	0,13	0,13	0,14	0,15	0,07
	Malleable cast iron	0,11	0,11	0,12	0,12	0,13	0,13	0,14	0,15	0,07
N	Aluminium wrought alloys									
	Aluminum cast alloys									
	Copper and copper alloys (bronze/brass)									
S	Heat-resistant alloys									
	Titanium alloys									
H	Hardened steel									
	Hard cast iron									
	Hardened cast iron									
X	Non-metallic materials									

Note: The given cutting values are guide values, which were determined under ideal conditions.
The values have to be adapted in individual cases.

Indexable milling – group 6 (FMD03, FME04, FMP03, HMP01)

Material group	Feed rate per cutting edge [mm]																		
	FMD03			FMD03			FME04			FMP03			FMP03			FMP03			
	LNKT20			LNKT25			LNKT15			LNKT12			LNKT15			LNKT20			
	Application																		
	F	M	R	F	M	R	F	M	R	F	M	R	F	M	R	F	M	R	
P	Unalloyed steel			0,50			0,50			0,45			0,45			0,45			0,50
	Low-alloyed steel			0,47			0,47			0,42			0,42			0,42			0,47
	High-alloyed steel and high-alloyed tool steel			0,44			0,44			0,40			0,40			0,40			0,44
M	Stainless steel			0,45			0,45			0,40			0,40			0,40			0,45
K	Grey cast iron			0,55			0,55			0,50			0,50			0,50			0,55
	Cast iron with spheroidal graphite			0,50			0,50			0,45			0,45			0,45			0,50
	Malleable cast iron			0,50			0,50			0,45			0,45			0,45			0,50
N	Aluminium wrought alloys																		
	Aluminum cast alloys																		
	Copper and copper alloys (bronze/brass)																		
S	Heat-resistant alloys																		
	Titanium alloys																		
H	Hardened steel																		
	Hard cast iron																		
	Hardened cast iron																		
X	Non-metallic materials																		

Note: The given cutting values are guide values, which were determined under ideal conditions.
The values have to be adapted in individual cases.

Recommended feed rate

Indexable milling – group7 (XMR01, XMP01, QCH)

Material group	Feed rate per cutting edge [mm]									
	XMR01 face milling			XMR01 plunge milling			XMR01 circular milling			
	SDMT/WPGT			SDMT/WPGT			SDMT/WPGT			
	Tool diameter [mm]									
	20-25	30-50	63-160	20-25	30-50	63-160	20-25	30-50	63-160	
P	Unalloyed steel	1,00	1,20	2,00	0,20	0,25	0,30	0,80	0,96	1,40
	Low-alloyed steel	0,93	1,12	1,86	0,19	0,23	0,28	0,74	0,89	1,30
	High-alloyed steel and high-alloyed tool steel	0,70	0,84	1,40	0,18	0,22	0,26	0,70	0,84	1,23
M	Stainless steel	0,50	0,60	1,00	0,14	0,18	0,21	0,56	0,67	0,98
K	Grey cast iron	0,90	1,08	1,80	0,22	0,28	0,33	0,88	1,06	1,54
	Cast iron with spheroidal graphite	0,90	1,08	1,80	0,20	0,25	0,30	0,80	0,96	1,40
	Malleable cast iron	1,00	1,20	2,00	0,20	0,25	0,30	0,80	0,96	1,40
N	Aluminium wrought alloys									
	Aluminum cast alloys									
	Copper and copper alloys (bronze/brass)									
S	Heat-resistant alloys									
	Titanium alloys									
H	Hardened steel									
	Hard cast iron									
	Hardened cast iron									
X	Non-metallic materials									

Note: The given cutting values are guide values, which were determined under ideal conditions.
The values have to be adapted in individual cases.

A

Turning

B

Milling

C

Drilling

D

Technical Information

E

Index

Feed rate per cutting edge [mm]								
	XMP01	QCH	QCH	QCH	QCH	QCH	QCH	
	CNE	ZOHX	RD*	APKT	WPGT	SDMT	XPHT	
Tool diameter [mm]								
	80-400	16-32	15-32	16-40	20-42	20-40	16-32	
	0,20	0,20	0,20	0,15	1,00	1,00	0,20	
	0,20	0,19	0,19	0,14	0,93	0,93	0,19	
	0,20	0,18	0,18	0,13	0,70	0,70	0,18	
	0,20	0,14	0,14	0,11	0,50	0,50	0,14	
	0,20	0,22	0,22	0,17	0,90	0,90	0,22	
	0,20	0,20	0,20	0,15	0,90	0,90	0,20	
	0,20	0,20	0,20	0,15	1,00	1,00	0,20	
				0,13				
				0,13				
				0,11				

- A
- Turning
- B
- Milling
- C
- Drilling
- D
- Technical Information
- E
- Index

ARBIDE MILLING

SOLID CARBIDE MILLING



Solid carbide milling

Product overview	B266-B275
Grade overview	B276-B277
System code – DIN-ISO series	B278
System code – JIS series	B279
System code – QCH series	B280-B282
GM series	B283-B338
PM series	B339-B360
PM Micro series	B361-B370
EPM series	B371-B386
VPM series	B387-B388
HM series	B389-B410
NM series	B411-B416
AL series	B417-B428
ALG/ALP series	B429-B438
TM series	B439-B454
HPC series	B455-B460
UM series	B461-B470
UMC series	B471-B472
VSM series	B473-B476
Deburring cutters – FM series	B477-B480
QCH series	B481-B491
Recommended cutting data	B492-B526
Technical information	B537-B540
Special tools	B541

B

A

Turning

B

Milling

C

Drilling

















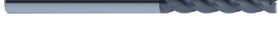

D

Technical
Information

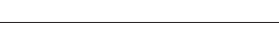
E

Index

High performance milling

Products	Solid carbide cutters	Teeth	Ø	Application						Type	Page
				P	M	K	N	S	H		
PM-2E		2	1.0-20.0	✓	✓	✓			✓	End mills	B339
PM-2EL		2	3.0-20.0	✓	✓	✓			✓	End mills	B340
PM-4E-G		4	1.0-20.0	✓	✓	✓			✓	End mills	B341
PM-4EL-G		4	3.0-20.0	✓	✓	✓			✓	End mills	B342
PM-4EX-G		4	3.0-20.0	✓	✓	✓			✓	End mills	B343
PM-4E		4	1.0-20.0	✓	✓	✓			✓	End mills	B344
PM-4EL		4	3.0-20.0	✓	✓	✓			✓	End mills	B345
PM-6E		6	6.0-20.0	✓	✓	✓			✓	End mills	B346
PM-6EL		6	6.0-20.0	✓	✓	✓			✓	End mills	B347
PM-2B		2	1.0-20.0	✓	✓	✓			✓	Ball nose cutters	B348
PM-2BL		2	2.0-20.0	✓	✓	✓			✓	Ball nose cutters	B349
PM-2BFP		2	1.0-20.0	✓	✓	✓			✓	Ball nose cutters	B350
PM-2BC		2	0.5-4.0	✓	✓	✓			✓	Ball nose cutter with conical neck	B351
PM-4B		4	3.0-20.0	✓	✓	✓			✓	Ball nose cutters	B354
PM-4BL		4	3.0-20.0	✓	✓	✓			✓	Ball nose cutters	B355
PM-2R		2	1.0-12.0	✓	✓	✓			✓	Torus mills	B356
PM-4H		4	3.0-12.0	✓	✓	✓			✓	High-feed mills	B357
PM-4HL		4	4.0-12.0	✓	✓	✓			✓	High-feed mills	B358
PM-4R		4	3.0-12.0	✓	✓	✓			✓	Torus mills	B359
PM-4RL		4	6.0-16.0	✓	✓	✓			✓	Torus mills	B360
PM-2EP		2	0.5-5.0	✓	✓	✓			✓	End mills	B362

✓ Very suitable ✓ Suitable

A

Turning

B

Milling

C

Drilling





















D

Technical Information

E

Index

High performance milling

Products	Solid carbide cutters	Teeth	Ø	Application						Type	Page
				P	M	K	N	S	H		
PM-2ES		2	0.3-3.0	✓	✓	✓			✓	End mills	B361
PM-2BS		2	0.3-3.0	✓	✓	✓			✓	Ball nose cutters	B364
PM-2BP		2	0.5-5.0	✓	✓	✓			✓	Ball nose cutters	B365
PM-2RP		2	0.5-5.0	✓	✓	✓			✓	Torus mills	B367
EPM-2E		2	3.0-20.0	✓	✓	✓			✓	End mills	B371
EPM-2E-W		2	3.0-20.0	✓	✓	✓			✓	End mills	B372
EPM-2EL		2	3.0-20.0	✓	✓	✓			✓	End mills	B373
EPM-2EL-W		2	3.0-20.0	✓	✓	✓			✓	End mills	B374
EPM-4E		4	3.0-20.0	✓	✓	✓			✓	End mills	B375
EPM-4E-W		4	3.0-20.0	✓	✓	✓			✓	End mills	B376
EPM-4EL		4	3.0-20.0	✓	✓	✓			✓	End mills	B377
EPM-4EL-W		4	3.0-20.0	✓	✓	✓			✓	End mills	B378
EPM-2B		2	3.0-20.0	✓	✓	✓			✓	Ball nose cutters	B379
EPM-2B-W		2	3.0-20.0	✓	✓	✓			✓	Ball nose cutters	B380
EPM-2BL		2	3.0-20.0	✓	✓	✓			✓	Ball nose cutters	B381
EPM-2BL-W		2	3.0-20.0	✓	✓	✓			✓	Ball nose cutters	B382
EPM-4B		4	3.0-20.0	✓	✓	✓			✓	Ball nose cutters	B383
EPM-4B-W		4	3.0-20.0	✓	✓	✓			✓	Ball nose cutters	B384
EPM-4BL		4	3.0-20.0	✓	✓	✓			✓	Ball nose cutters	B385
EPM-4BL-W		4	3.0-20.0	✓	✓	✓			✓	Ball nose cutters	B386
VPM-4E		4	3.0-20.0	✓	✓	✓			✓	End mills	B387

✓ Very suitable ✓ Suitable

A

Turning

B

Milling

C

Drilling













D

Technical
Information

E

Index

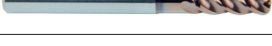
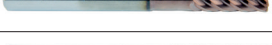
High performance milling

Products	Solid carbide cutters	Teeth	Ø	Application						Type	Page
				P	M	K	N	S	H		
TM-4B		2	6.0-20.0		✓			✓		Ball nose cutters	B439
TM-4BL		2	6.0-20.0		✓			✓		Ball nose cutters	B440
TM-4BP		2	6.0-20.0		✓			✓		Ball nose cutters	B441
TM-5B		2	6.0-20.0		✓			✓		Ball nose cutters	B442
TM-5BL		2	6.0-20.0		✓			✓		Ball nose cutters	B443
TM-5BP		2	6.0-20.0		✓			✓		Ball nose cutters	B444
TM-4R		2	6.0-25.0		✓			✓		Torus mills	B445
TM-4RP		2	8.0-25.0		✓			✓		Torus mills	B447
TM-5R		2	6.0-10.0		✓			✓		Torus mills	B449
TM-7R		2	12.0-21.0		✓			✓		Torus mills	B450
TM-9R		2	25.0		✓			✓		Torus mills	B451
TM-5RP		2	8.0-10.0		✓			✓		Torus mills	B452
TM-7RP		2	12.0-20.0		✓			✓		Torus mills	B453
TM-9RP		2	25.0		✓			✓		Torus mills	B454

















✓ Very suitable ✓ Suitable

General machining

5501R302GM		2	3.0-20.0	✓	✓	✓				End mills	B283
5601R302GM		2	3.0-20.0	✓	✓	✓				End mills	B284
5502R302GM		2	1.0-20.0	✓	✓	✓				End mills	B285
5602R302GM		2	2.0-20.0	✓	✓	✓				End mills	B286
GM-2E		2	1.0-20.0	✓	✓	✓				End mills	B287
GM-2EL		2	3.0-20.0	✓	✓	✓				End mills	B288

✓ Very suitable ✓ Suitable

General machining

Products	Solid carbide cutters	Teeth	Ø	Application						Type	Page
				P	M	K	N	S	H		
GM-2EX		2	3.0-20.0	✓	✓	✓				End mills	B289
GM-2EFP		2	6.0-16.0	✓	✓	✓				End mills	B290
GM-2F		2	1.0-20.0	✓	✓	✓				End mills	B291
GM-2FL		2	3.0-20.0	✓	✓	✓				End mills	B292
GM-2EP		2	0.5-5.0	✓	✓	✓				Mini end mills	B293
GM-2ES		2	0.3-3.0	✓	✓	✓				Mini end mills	B295
GM-3E		3	1.0-20.0	✓	✓	✓				End mills	B296
GM-3EL		3	3.0-20.0	✓	✓	✓				End mills	B297
5501R303GM		3	3.0-20.0	✓	✓	✓				End mills	B298
5601R303GM		3	3.0-20.0	✓	✓	✓				End mills	B299
5502R303GM		3	3.0-20.0	✓	✓	✓				End mills	B300
5602R303GM		3	3.0-20.0	✓	✓	✓				End mills	B301
5502R453GM		3	3.0-20.0	✓	✓	✓				End mills	B302
5602R453GM		3	3.0-20.0	✓	✓	✓				End mills	B303
GM-4F-G		4	1.0-20.0	✓	✓	✓				End mills	B304
GM-4EL-G		4	3.0-20.0	✓	✓	✓				End mills	B305
GM-4FL-G		4	3.0-16.0	✓	✓	✓				End mills	B306
GM-4EX-G		4	3.0-20.0	✓	✓	✓				End mills	B307
GM-4E		4	1.0-20.0	✓	✓	✓				End mills	B308
GM-4E-G		4	1.0-20.0	✓	✓	✓				End mills	B309
GM-4EL		4	3.0-20.0	✓	✓	✓				End mills	B310

✓ Very suitable ✓ Suitable

A

Turning

B

Milling

C

Drilling







D

Technical Information

E

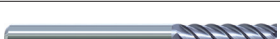
Index





General machining

Products	Solid carbide cutters	Teeth	Ø	Application						Type	Page
				P	M	K	N	S	H		
GM-4EFP		4	6.0-20.0	✓	✓	✓				End mills	B311
5501R304GF		4	3.0-20.0	✓	✓	✓				End mills	B312
5601R304GF		4	3.0-20.0	✓	✓	✓				End mills	B313
5502R304GF		4	3.0-20.0	✓	✓	✓				End mills	B314
5602R304GF		4	3.0-20.0	✓	✓	✓				End mills	B315
5508R454GM		4	3.0-20.0	✓	✓	✓				End mills	B316
5602R454GM		4	3.0-20.0	✓	✓	✓				End mills	B317
5589R45MGFR		6-10	6.0-12.0	✓	✓	✓				End mills	B318
GM-6E		6	6.0-20.0	✓	✓	✓				End mills	B319
GM-6EL		6	6.0-20.0	✓	✓	✓				End mills	B320
5565R302GF		2	3.0-20.0	✓	✓	✓				Ball nose cutters	B321
5665R202GM		2	3.0-20.0	✓	✓	✓				Ball nose cutters	B322
5566R302GF		2	3.0-12.0	✓	✓	✓				Ball nose cutters	B323
GM-2B		2	1.0-20.0	✓	✓	✓				Ball nose cutters	B324
GM-2BL		2	2.0-20.0	✓	✓	✓				Ball nose cutters	B325
GM-2BFP		2	1.0-20.0	✓	✓	✓				Ball nose cutters	B326
GM-2BS		2	0.3-3.0	✓	✓	✓				Mini ball nose cutters	B327
GM-2BP		2	0.5-5.0	✓	✓	✓				Mini ball nose cutters	B328
GM-4B		4	3.0-20.0	✓	✓	✓				Ball nose cutters	B330
GM-4BL		4	3.0-20.0	✓	✓	✓				Ball nose cutters	B331
GM-2R		2	1.0-12.0	✓	✓	✓				Torus mills	B332

✓ Very suitable ✓ Suitable





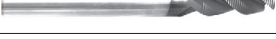
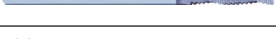



A
Turning
B
Milling
C
Drilling
D
Technical Information
E
Index

General machining

Products	Solid carbide cutters	Teeth	Ø	Application						Type	Page
				P	M	K	N	S	H		
GM-4R		4	3.0-12.0	✓	✓	✓				Torus mills	B333
GM-4RL		4	6.0-16.0	✓	✓	✓				Torus mills	B334
5602R303GR		3	6.0-8.0	✓	✓	✓				Rippers	B335
5602R304GR		4	10.0-20.0	✓	✓	✓				Rippers	B336
5602R305GR		5	25.0	✓	✓	✓				Rippers	B337
GM-4W		4	6.0-20.0	✓	✓	✓				Rippers	B338

✓ Very suitable ✓ Suitable

Machining high hardness steel

HM-2E		2	1.0-20.0						✓	End mills	B389
HM-2EFP		2	6.0-20.0						✓	End mills	B390
HM-2EP		2	0.5-5.0						✓	Mini end mills	B391
HM-2ES		2	0.3-3.0						✓	Mini end mills	B393
HM-4E		4	1.0-20.0						✓	End mills	B394
HM-4EL		4	3.0-20.0						✓	End mills	B395
HM-4EFP		4	6.0-20.0						✓	End mills	B396
5502R55MHH		4-8	3.0-20.0						✓	End mills	B397
HM-6E		6	6.0-20.0						✓	End mills	B398
HM-6EL		6	6.0-20.0						✓	End mills	B399
HM-2B		2	1.0-20.0						✓	Ball nose cutters	B400
HM-2BL		2	2.0-20.0						✓	Ball nose cutters	B401
HM-2BFP		2	1.0-20.0						✓	Ball nose cutters	B402
HM-2BS		2	0.3-3.0						✓	Mini ball nose cutters	B403

✓ Very suitable ✓ Suitable

A

Turning

B

Milling

C

Drilling

D

Technical Information







E

Index

A

Turning

Machining high hardness steel







Products	Solid carbide cutters	Teeth	Ø	Application						Type	Page
				P	M	K	N	S	H		
HM-2BP		2	0.5-5.0						✓	Mini ball nose cutters	B404
HM-4B		4	3.0-20.0						✓	Ball nose cutters	B406
HM-4BL		4	3.0-20.0						✓	Ball nose cutters	B407
HM-4R		4	3.0-12.0						✓	Torus mills	B408
HM-4RF		4	6.0-12.0						✓	Torus mills	B409
HM-4RP		4	6.0-16.0						✓	Torus mills	B410

✓ Very suitable ✓ Suitable

B

Milling

Copper and copper alloys

5502R402NM		2	3.0-20.0				✓			End mills	B411
NM-2E		2	1.0-12.0				✓			End mills	B412
NM-2EP		2	0.5-5.0				✓			Mini end mills	B413
NM-4E		4	3.0-12.0				✓			End mills	B414
NM-2B		2	1.0-12.0				✓			Ball nose cutters	B415
NM-2BP		2	0.5-5.0				✓			Mini ball nose cutters	B416

✓ Very suitable ✓ Suitable

C

Drilling

D

Technical Information

Aluminium and aluminium alloys















AL-2E		2	1.0-20.0				✓			End mills	B417
AL-2EL		2	3.0-20.0				✓			End mills	B418
AL-3E		3	1.0-20.0				✓			End mills	B419
AL-3EL		3	3.0-20.0				✓			End mills	B420
AL-3W		3	6.0-20.0				✓			Rippers	B421
5565R302NH		2	3.0-16.0				✓			Ball nose cutters	B422
5566R302NH		2	3.0-16.0				✓			Ball nose cutters	B423

✓ Very suitable ✓ Suitable

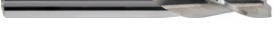
E

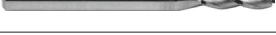
Index

Aluminium and aluminium alloys

Products	Solid carbide cutters	Teeth	Ø	Application						Type	Page
				P	M	K	N	S	H		
AL-2B		2	2.0-12.0				✓			Ball nose cutters	B424
AL-2R-AIR		2	6.0-20.0				✓			High performance torus mills	B425
AL-2RL-AIR		2	6.0-20.0				✓			High performance torus mills	B426
AL-3R-AIR		3	12.0-20.0				✓			High performance torus mills	B427
AL-3RL-AIR		3	12.0-20.0				✓			High performance torus mills	B428
ALG-2E		2	1.0-20.0				✓			End mills	B429
ALG-3E		3	1.0-20.0				✓			End mills	B430
ALG-3E-W		3	3.0-20.0				✓			End mills	B431
ALP-3E		3	1.0-20.0				✓			End mills	B432
ALP-3E-W		3	3.0-20.0				✓			End mills	B433
ALP-4E		4	3.0-20.0				✓			End mills	B434
ALP-4E-W		4	3.0-20.0				✓			End mills	B435
ALG-2R		2	6.0-25.0				✓			Torus mills	B436
ALG-2R-W		2	6.0-25.0				✓			Torus mills	B437

✓ Very suitable ✓ Suitable

HPC with unequal helix angle

5501R38414GM		4	4.0-20.0	✓	✓	✓			✓	End mills	B455
5502R38414GM		4	4.0-20.0	✓	✓	✓			✓	End mills	B456
5601R38414GM		4	4.0-20.0	✓	✓	✓			✓	End mills	B457
5602R38414GM		4	4.0-20.0	✓	✓	✓			✓	End mills	B458
5502R38414GM-R		4	4.0-20.0	✓	✓	✓			✓	Torus mills	B459
5602R38414GM-R		4	4.0-20.0	✓	✓	✓			✓	Torus mills	B460

✓ Very suitable ✓ Suitable

A

Turning

B

Milling

C

Drilling

D

Technical Information

E





Index

HPC with unequal helix angle

Products	Solid carbide cutters	Teeth	Ø	Application						Type	Page
				P	M	K	N	S	H		
UM-4E		4	4.0-20.0	✓	✓	✓			✓	End mills	B461
UM-4E-W		4	4.0-20.0	✓	✓	✓			✓	End mills	B462
UM-4EL		4	4.0-20.0	✓	✓	✓			✓	End mills	B463
UM-4EL-W		4	4.0-20.0	✓	✓	✓			✓	End mills	B464
UM-4ELP-W		4	4.0-20.0	✓	✓	✓			✓	End mills	B465
UM-4EFP		4	6.0-20.0	✓	✓	✓			✓	End mills	B466
UM-4R		4	4.0-20.0	✓	✓	✓			✓	Torus mills	B467
UM-4RL		4	6.0-16.0	✓	✓	✓			✓	Torus mills	B468
UM-4RFP		4	6.0-16.0	✓	✓	✓			✓	Torus mills	B469
UM-5EP-W		5	6.0-25.0	✓	✓	✓			✓	End mills	B470
UMC-4E		4	6.0-20.0	✓	✓	✓			✓	End mills	B471
UMC-4E-W		4	6.0-20.0	✓	✓	✓			✓	End mills	B472
VSM-4E		4	4.0-20.0	✓	✓			✓		End mills	B473
VSM-4E-C		4	10.0-20.0	✓	✓			✓		End mills	B474
VSM-4R		4	4.0-20.0	✓	✓			✓		Torus mills	B475

✓ Very suitable ✓ Suitable

Deburring cutter

5501/5601		3-4	0.2-0.7	✓	✓	✓	✓			Deburring cutters	B477
5501/5601		3-4	0.2-0.7	✓	✓	✓	✓			Deburring cutters	B478
5501/5601		3-4	0.2-0.7	✓	✓	✓	✓			Deburring cutters	B479
5601		4	5.2-10.0	✓	✓	✓	✓			Deburring cutters	B480

✓ Very suitable ✓ Suitable

A

Turning

B

Milling

C

Drilling



D

Technical Information

E

Index

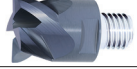
QCH series

Products	Solid carbide cutters	Teeth	Ø	Application						Type	Page
				P	M	K	N	S	H		
PM-2B		2	12.0-32.0	✓	✓	✓			✓	Ball nose cutters	B481
PM-4B		4	12.0-32.0	✓	✓	✓			✓	Ball nose cutters	B482
PM-4E		4	12.0-32.0	✓	✓	✓			✓	End mills	B483
PM-4R		4	12.0-32.0	✓	✓	✓			✓	Torus mills	B484
HMX-2B		2	12.0-32.0						✓	Ball nose cutters	B486
HMX-4B		4	12.0-32.0						✓	Ball nose cutters	B487
HMX-4E		4	12.0-32.0						✓	End mills	B488
HMX-4R		4	12.0-32.0						✓	Torus mills	B489
VPM-4E		4	12.0-25.0	✓	✓	✓			✓	End mills	B485

✓ Very suitable ✓ Suitable

A

Turning

B

Milling

C

Drilling

D

Technical Information

E

Index

A

Turning

Coated cemented carbide PVD

Grade	Grade description
KMD401	PVD coated carbide substrate for high performance milling application of non-ferrous metals, CFRP and GFRP and organic materials. The DLC layer has very good wear protection and high thermal stability.

B

Milling

KMG303	PVD coated carbide substrate for universal milling application of steel (up to HRC<=48), stainless steel and cast iron.
---------------	---

KMG405	PVD coated carbide substrate for high performance milling application of steel (up to HRC <55), stainless steel, super alloy material and cast iron. High wear resistance and toughness for a wide application field.
---------------	---

C

Drilling

KMG406	PVD coated carbide substrate for entry into high performance machining. Universal range of application for steel and cast materials up to 55 HRC as well as stainless steel.
---------------	--

KMG555	PVD coated carbide substrate for hard milling application of steel (HRC 55–68), highest wear resistance and toughness for best cutting result.
---------------	--

D

Technical Information

KMG309	PVD coated carbide substrate for non ferrous materials. High wear resistance even in abrasive materials.
---------------	--

Uncoated cemented carbide

Grade	Grade description
YK30F	Uncoated K30 carbide substrate for steel, stainless steel, cast iron and non ferrous materials.

E

Index

Uncoated cemented carbide

Grade	Grade description
YK40F	Uncoated K20–K30/N20–N30 carbide substrate for cast iron and non ferrous materials.

A

Turning

B

Milling

C

Drilling

D

Technical
Information

E

Index

5 5 0 1 R 30 2 GM R05 0800

1 2 3 4 5 6 7 8 9 10

A

Turning

Type	
Code	Description
5	Milling cutter

Shank type	
Code	Description
1	Shank
5	DIN 6535 HA
6	Weldon shank DIN 6535 HB
7	Whistle Notch DIN 6535 HE
9	Morse taper shank

B

Milling

1

2

Cutting edge type	
Code	Description
0	Square shoulder mill
6	Ball nose cutter
8	Torus mill

Tool length	
Code	Description
1	DIN 6527 K
2	DIN 6527 L
5	Factory standard ZCC-A
6	Factory standard ZCC-B
8	DIN 6528
9	Factory standard ZCC-D

C

Drilling

3

4

Rotation direction	
Code	Description
R	Right
L	Left

Helix angle	
Code	Description
20	20°
30	30°
3841	38°/41°
45	45°
55	55°
60	60°

Number of teeth	
Code	Description
2	2
...	
M	Indicated when different diameters have a different number of teeth

D

Technical Information

5

6

7

Application	
Code	Description
GM	Semi-finishing
GF	Finishing
HM	Hard machining
MHH	High-speed hard machining
NH	High-performance machining of heat-resistant alloys

Radius [mm]	
Code	Description
R03	0,3
R15	1,5
R30	3,0
...	

Diameter [mm]	
Code	Description
0100	1,0
0800	8,0
2000	20,0
...	

8

9

10

E

Index

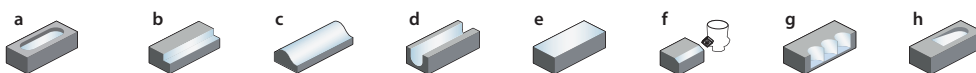

a Groove milling
g Plunge milling
b Square shoulder milling
h Circular milling/Ramping
c Profile milling
d Slot milling
e Face milling
f Chamfer milling

GM – 2 E L P – D12 R0.5 – M08

1 2 3 4 5 6 7 8

Application	
Code	Description
GR	General roughing
GM	Semi-finishing
GF	Finishing
PM	High-performance machining
EPM	«Ecoline» – High-performance machining
VPM	Full-slot applications
HM	Hard machining
NM	General machining of non-ferrous metals
AL	General machining of Al and Al alloys
ALP	High-performance machining of Al and Al alloys
ALG	General machining of Al and Al alloys
UM	HSC/HPC machining
UMC	HSC machining with chip splitter geometry
VSM	General machining of heat-resistant alloys
TM	General machining of heat-resistant alloys

Number of teeth

1 **2**

Cutting edge type	
Code	Description
E	Square shoulder mill with protective chamfer
F	Square shoulder mill with sharp cutting edges
B	Ball nose cutter
R	Torus mill
W	Ripper
H	High-feed mill

3

Cutting edge length	
Code	Description
L	Long
X	Extra long
F	Short

4

Type	
Code	Description
S	Mini diameter
P	Ground neck
C	Conical neck

5

Diameter [mm]	
Code	Description
D3.0	3,0
D20.0	20,0
...	

6

Radius [mm]	
Code	Description
R0.5	0,5
R3.0	3,0
...	

7

Features	
Code	Description
G	Spiral angle 30°
M	Neck length [mm]
S	Thin shank
AIR	For aerospace industry

8

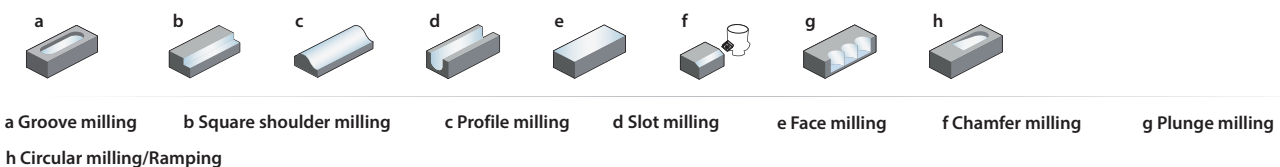

Q 08 – PM – 2 B – D12 R0.5

1

2

3

4

5

6

7

Thread type

Thread diameter [mm]

Code	Description
08	8,0
10	10,0
12	12,0
14	14,0
18	18,0

Application

Code	Description
PM	High-performance machining
HMX	Hard machining

1

2

3

Number of teeth

Cutting edge type

Code	Description
E	Square shoulder mill with protective chamfer
B	Ball nose cutter
R	Torus mill

Diameter [mm]

Code	Description
D3.0	3,0
D8.0	8,0
D20.0	20,0

4

5

6

Radius [mm]

Code	Description
R0.5	0,5
R1.0	1,5
R3.0	3,0
...	

7



a Groove milling

b Square shoulder milling

c Profile milling

d Slot milling

e Face milling

f Chamfer milling

g Plunge milling

h Circular milling/Ramping

G 25 – QCH – Q 12 – 250 C – (ZJ) (115)

A

1

2

3

4

5

6

7

8

9

Turning

Clamping form	
Code	Description
G	Cylindrical
XP	Weldon

1

Clamping diameter [mm]	
Code	Description
12	12
16	16
20	20
25	25
32	32

2

Series [mm]	
Code	Description
QCH	Indexable head system

3

B

Thread type	
Code	Description
M	Metric
Q	Q thread

4

Thread size [mm]	
Code	Description
8	8
10	10
12	12
14	14
...	

5

Total length [mm]	
Code	Description
85	85
150	150
200	200
...	

6

Milling

Material	
Code	Description
C	Solid carbide
S	Steel

7

Shank	
Code	Description
ZJ	Conical
-	Cylindrically stepped

8

Taper length [mm]	
Code	Description
90	90
115	115
...	

9

C

Drilling

D

Technical
Information

E

Index

Notes

A

Turning

B

Milling

C

Drilling

D

Technical
Information

E

Index

End mill **Semi-finishing**

5501R302GM

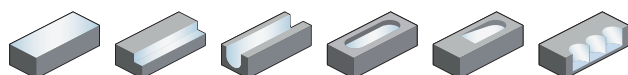

- Type of shank DIN 6535HA
- Centre cutting
- Helix angle 30°

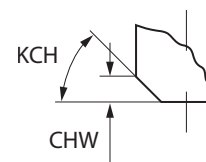
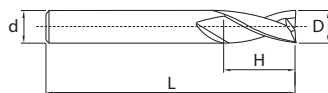
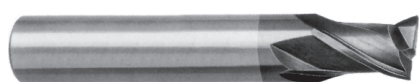

Article	*	Dimensions [mm]						Teeth	Grade	
		D	d (h6)	H	L	KCH	CHW		KMG303	YK30F
5501R302GM-0300		3	6	4	50	0	0	2	●	○
5501R302GM-0400		4	6	5	54	0	0	2	●	○
5501R302GM-0500		5	6	6	54	0	0	2	●	○
5501R302GM-0600		6	6	7	54	45	0.1	2	●	○
5501R302GM-0800		8	8	9	58	45	0.1	2	●	○
5501R302GM-1000		10	10	11	66	45	0.1	2	●	○
5501R302GM-1200		12	12	12	73	45	0.1	2	●	○
5501R302GM-1400		14	14	14	75	45	0.15	2	●	○
5501R302GM-1600		16	16	16	82	45	0.15	2	●	○
5501R302GM-1800		18	18	18	84	45	0.15	2	●	○
5501R302GM-2000		20	20	20	92	45	0.15	2	●	○

● Ex stock ○ On demand

* With internal cooling

Application field					
P	M	K	N	S	H
✓	✓	✓			

✓ Very suitable

✓ Suitable

System code > B278

Cutting data > B492

Nonstandard order > B541



A

End mill

Semi-finishing

Turning

5601R302GM

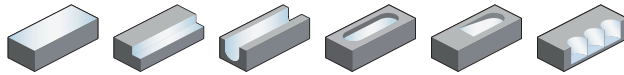

- Type of shank: DIN 6535HB
- Centre cutting
- Helix angle 30°

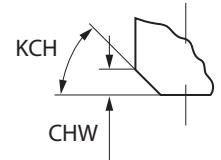
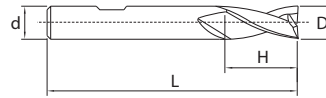
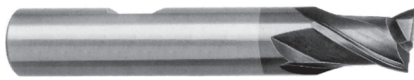

B

Milling

Article	*	Dimensions [mm]						Teeth	Grade
		D	d (h6)	H	L	KCH	CHW		KMG303
5601R302GM-0300		3	6	4	50	0	0	2	●
5601R302GM-0400		4	6	5	54	0	0	2	●
5601R302GM-0500		5	6	6	54	0	0	2	●
5601R302GM-0600		6	6	7	54	45	0.1	2	●
5601R302GM-0800		8	8	9	58	45	0.1	2	●
5601R302GM-1000		10	10	11	66	45	0.1	2	●
5601R302GM-1200		12	12	12	73	45	0.1	2	●
5601R302GM-1400		14	14	14	75	45	0.15	2	●
5601R302GM-1600		16	16	16	82	45	0.15	2	●
5601R302GM-1800		18	18	18	84	45	0.15	2	●
5601R302GM-2000		20	20	20	92	45	0.15	2	●

● Ex stock ○ On demand

* With internal cooling

C

Drilling

Application field

P	M	K	N	S	H
✓	✓	✓			

- ✓ Very suitable
- ✓ Suitable

D

Technical Information

E

Index

System code > B278

Cutting data > B492

Nonstandard order > B541

End mill long cutting edge **Semi-finishing**

5502R302GM

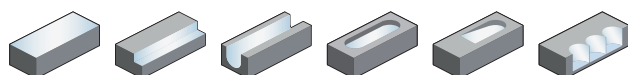

- Type of shank DIN 6535HA
- Centre cutting
- Helix angle 30°

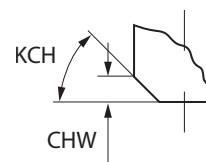
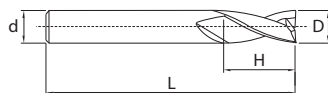
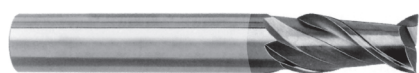

Article	*	Dimensions [mm]						Teeth	Grade	
		D	d (h6)	H	L	KCH	CHW		KMG303	YK30F
5502R302GM-0100		1	3	2	38	0	0	2	●	○
5502R302GM-0150		1.5	3	3	38	0	0	2	●	○
5502R302GM-0200		2	6	6	57	0	0	2	●	○
5502R302GM-0250		2.5	6	7	57	0	0	2	●	○
5502R302GM-0280		2.8	6	7	57	0	0	2	●	○
5502R302GM-0300		3	6	7	57	0	0	2	●	○
5502R302GM-0350		3.5	6	7	57	0	0	2	●	○
5502R302GM-0380		3.8	6	8	57	0	0	2	●	○
5502R302GM-0400		4	6	8	57	0	0	2	●	○
5502R302GM-0450		4.5	6	8	57	0	0	2	●	○
5502R302GM-0480		4.8	6	8	57	0	0	2	●	○
5502R302GM-0500		5	6	10	57	0	0	2	●	○
5502R302GM-0550		5.5	6	10	57	0	0	2	●	○
5502R302GM-0575		5.75	6	10	57	0	0	2	●	○
5502R302GM-0600		6	6	10	57	45	0.1	2	●	○
5502R302GM-0675		6.75	8	13	63	45	0.1	2	○	○
5502R302GM-0700		7	8	13	63	45	0.1	2	●	○
5502R302GM-0750		7.5	8	16	63	45	0.1	2	●	○
5502R302GM-0775		7.75	8	16	63	45	0.1	2	●	○
5502R302GM-0800		8	8	16	63	45	0.1	2	●	○
5502R302GM-0870		8.7	10	16	72	45	0.1	2	●	○
5502R302GM-0900		9	10	16	72	45	0.1	2	●	○
5502R302GM-0950		9.5	10	16	72	45	0.1	2	○	○
5502R302GM-1000		10	10	19	72	45	0.1	2	●	○
5502R302GM-1100		11	12	22	83	45	0.1	2	●	○
5502R302GM-1170		11.7	12	22	83	45	0.1	2	●	○
5502R302GM-1200		12	12	22	83	45	0.1	2	●	○
5502R302GM-1370		13.7	14	22	83	45	0.1	2	●	○
5502R302GM-1400		14	14	22	83	45	0.15	2	●	○
5502R302GM-1500		15	16	26	92	45	0.15	2	●	○
5502R302GM-1570		15.7	16	26	92	45	0.15	2	●	○
5502R302GM-1600		16	16	26	92	45	0.15	2	●	○
5502R302GM-1700		17	18	26	92	45	0.15	2	○	○
5502R302GM-1800		18	18	26	92	45	0.15	2	●	○
5502R302GM-2000		20	20	32	104	45	0.15	2	●	○

● Ex stock ○ On demand

* With internal cooling

Application field					
P	M	K	N	S	H
✓	✓	✓			

✓ Very suitable

✓ Suitable

System code > B278 Cutting data > B492 Nonstandard order > B541



A

End mill long cutting edge Semi-finishing

5602R302GM

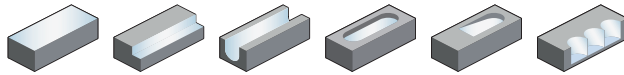

- Type of shank: DIN 6535HB
- Centre cutting
- Helix angle 30°

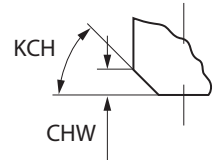
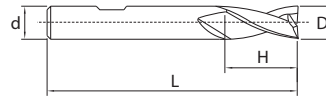

Turning

B

Article	*	Dimensions [mm]						Teeth	Grade KMG303
		D	d (h6)	H	L	KCH	CHW		
5602R302GM-0200		2	6	6	57	0	0	2	●
5602R302GM-0250		2.5	6	7	57	0	0	2	●
5602R302GM-0280		2.8	6	7	57	0	0	2	●
5602R302GM-0300		3	6	7	57	0	0	2	●
5602R302GM-0350		3.5	6	7	57	0	0	2	●
5602R302GM-0380		3.8	6	8	57	0	0	2	●
5602R302GM-0400		4	6	8	57	0	0	2	●
5602R302GM-0450		4.5	6	8	57	0	0	2	●
5602R302GM-0480		4.8	6	8	57	0	0	2	●
5602R302GM-0500		5	6	10	57	0	0	2	●
5602R302GM-0550		5.5	6	10	57	0	0	2	●
5602R302GM-0575		5.75	6	10	57	0	0	2	●
5602R302GM-0600		6	6	10	57	45	0.1	2	●
5602R302GM-0675		6.75	8	13	63	45	0.1	2	○
5602R302GM-0700		7	8	13	63	45	0.1	2	●
5602R302GM-0750		7.5	8	16	63	45	0.1	2	●
5602R302GM-0775		7.75	8	16	63	45	0.1	2	○
5602R302GM-0800		8	8	16	63	45	0.1	2	●
5602R302GM-0870		8.7	10	16	72	45	0.1	2	●
5602R302GM-0900		9	10	16	72	45	0.1	2	●
5602R302GM-1000		10	10	19	72	45	0.1	2	●
5602R302GM-1170		11.7	12	22	83	45	0.1	2	●
5602R302GM-1200		12	12	22	83	45	0.1	2	●
5602R302GM-1370		13.7	14	22	83	45	0.1	2	●
5602R302GM-1400		14	14	22	83	45	0.15	2	●
5602R302GM-1570		15.7	16	26	92	45	0.15	2	●
5602R302GM-1600		16	16	26	92	45	0.15	2	●
5602R302GM-1800		18	18	26	92	45	0.15	2	●
5602R302GM-2000		20	20	32	104	45	0.15	2	●

● Ex stock ○ On demand

* With internal cooling

Milling

C

Drilling

D

Technical Information

E

Index

Application field

P	M	K	N	S	H
✓	✓	✓			

- ✓ Very suitable
- ✓ Suitable

System code > B278

Cutting data > B492

Nonstandard order > B541

End mill **Semi-finishing**

GM-2E

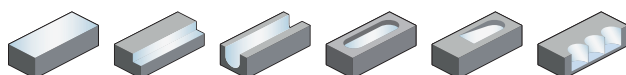

- Factory standard
- Centre cutting
- Helix angle 35°

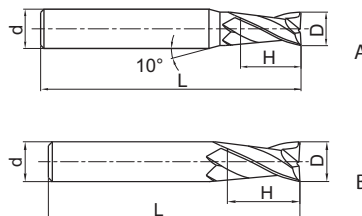

Article	*	Dimensions [mm]				Teeth	Geometry	Grade
		D	d (h6)	H	L			KMG303
GM-2E-D1.0S		1	4	3	50	2	A	●
GM-2E-D1.5S		1.5	4	4	50	2	A	●
GM-2E-D2.0S		2	4	6	50	2	A	●
GM-2E-D2.5S		2.5	4	8	50	2	A	●
GM-2E-D3.0S		3	4	8	50	2	A	●
GM-2E-D4.0S		4	4	11	50	2	B	●
GM-2E-D1.0		1	6	3	50	2	A	●
GM-2E-D1.5		1.5	6	4	50	2	A	●
GM-2E-D2.0		2	6	6	50	2	A	●
GM-2E-D2.5		2.5	6	8	50	2	A	●
GM-2E-D3.0		3	6	8	50	2	A	●
GM-2E-D3.5		3.5	6	10	50	2	A	●
GM-2E-D4.0		4	6	11	50	2	A	●
GM-2E-D4.5		4.5	6	11	50	2	A	●
GM-2E-D5.0		5	6	13	50	2	A	●
GM-2E-D5.5		5.5	6	16	50	2	A	●
GM-2E-D6.0		6	6	16	50	2	B	●
GM-2E-D7.0		7	8	20	60	2	A	●
GM-2E-D8.0		8	8	20	60	2	B	●
GM-2E-D9.0		9	10	22	75	2	A	●
GM-2E-D10.0		10	10	25	75	2	B	●
GM-2E-D11.0		11	12	26	75	2	A	●
GM-2E-D12.0		12	12	30	75	2	B	●
GM-2E-D14.0		14	14	32	75	2	B	●
GM-2E-D16.0		16	16	45	100	2	B	●
GM-2E-D18.0		18	18	45	100	2	B	●
GM-2E-D20.0		20	20	45	100	2	B	●

● Ex stock ○ On demand

* With internal cooling

Application field					
P	M	K	N	S	H
✓	✓	✓			

✓ Very suitable

✓ Suitable

System code > B278

Cutting data > B492

Nonstandard order > B541



A

End mill long cutting edge Semi-finishing

GM-2EL

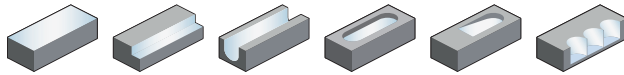

- Factory standard
- Centre cutting
- Helix angle 35°

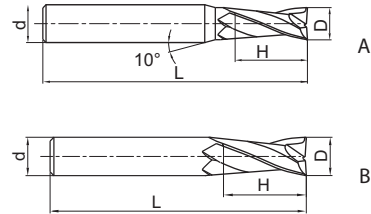

Turning

B

Milling

Article	*	Dimensions [mm]				Teeth	Geometry	Grade
		D	d (h6)	H	L			KMG303
GM-2EL-D3.0		3	6	12	75	2	A	●
GM-2EL-D4.0		4	6	15	75	2	A	●
GM-2EL-D5.0		5	6	20	75	2	A	●
GM-2EL-D6.0		6	6	20	75	2	B	●
GM-2EL-D8.0		8	8	25	100	2	B	●
GM-2EL-D10.0		10	10	30	100	2	B	●
GM-2EL-D12.0		12	12	35	100	2	B	●
GM-2EL-D14.0		14	14	40	100	2	B	●
GM-2EL-D16.0		16	16	50	150	2	B	●
GM-2EL-D20.0		20	20	55	150	2	B	●

● Ex stock ○ On demand

* With internal cooling

C

Drilling

Application field

P	M	K	N	S	H
✓	✓	✓			

✓ Very suitable

✓ Suitable

D

Technical Information

E

Index

System code > B278

Cutting data > B492

Nonstandard order > B541

End mill extra long cutting edge **Semi-finishing**

GM-2EX

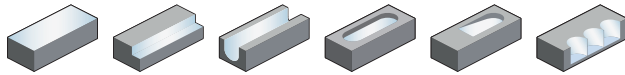

- Factory standard
- Centre cutting
- Helix angle 35°

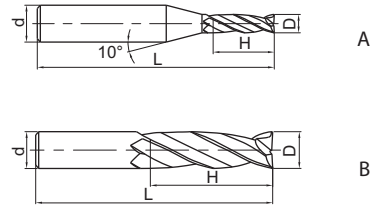

Article	*	Dimensions [mm]				Teeth	Geometry	Grade
		D	d (h6)	H	L			KMG303
GM-2EX-D3.0		3	6	20	75	2	A	●
GM-2EX-D4.0		4	6	25	75	2	A	●
GM-2EX-D5.0		5	6	30	75	2	A	●
GM-2EX-D6.0		6	6	30	75	2	B	○
GM-2EX-D8.0		8	8	40	100	2	B	○
GM-2EX-D10.0		10	10	50	110	2	B	○
GM-2EX-D12.0		12	12	50	110	2	B	○
GM-2EX-D16.0		16	16	70	150	2	B	○
GM-2EX-D20.0		20	20	75	150	2	B	○

- Ex stock ○ On demand
- * With internal cooling

Application field					
P	M	K	N	S	H
✓	✓	✓			

- ✓ Very suitable
- ✓ Suitable

A

Turning

B

Milling

C

Drilling

D

Technical Information

E

Index

System code > B278

Cutting data > B492

Nonstandard order > B541



A

End mill short cutting edge Semi-finishing

GM-2EFP

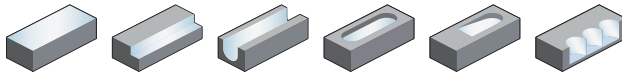

- Factory standard
- Centre cutting
- Helix angle 35°

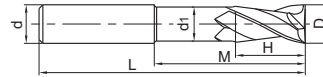

Turning

B

Article	*	Dimensions [mm]						Teeth	Grade
		D	d (h6)	d ₁	H	M	L		KMG303
GM-2EFP-D6.0		6	6	5.8	9	30	75	2	○
GM-2EFP-D8.0		8	8	7.8	12	40	100	2	○
GM-2EFP-D10.0		10	10	9.6	15	50	100	2	○
GM-2EFP-D12.0		12	12	11.5	18	50	100	2	○
GM-2EFP-D16.0		16	16	15.5	24	50	150	2	○

● Ex stock ○ On demand

* With internal cooling

Milling

C

Application field

P	M	K	N	S	H
✓	✓	✓			

✓ Very suitable

✓ Suitable

Drilling

D

Technical Information

E

Index

System code > B278

Cutting data > B492

Nonstandard order > B541

End mill **Semi-finishing**

GM-2F

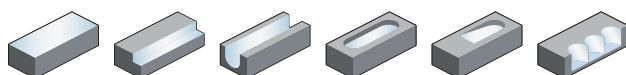

- Factory standard
- Centre cutting
- Helix angle 35°

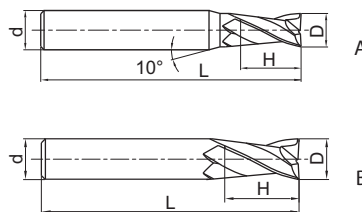

Article	*	Dimensions [mm]				Teeth	Geometry	Grade
		D	d (h6)	H	L			KMG303
GM-2F-D1.0		1	6	3	50	2	A	○
GM-2F-D1.5		1.5	6	4	50	2	A	○
GM-2F-D2.0		2	6	6	50	2	A	○
GM-2F-D2.5		2.5	6	8	50	2	A	○
GM-2F-D3.0		3	6	8	50	2	A	●
GM-2F-D3.5		3.5	6	10	50	2	A	○
GM-2F-D4.0		4	6	11	50	2	A	●
GM-2F-D4.5		4.5	6	11	50	2	A	●
GM-2F-D5.0		5	6	13	50	2	A	●
GM-2F-D5.5		5.5	6	16	50	2	A	○
GM-2F-D6.0		6	6	16	50	2	B	●
GM-2F-D7.0		7	8	20	60	2	A	●
GM-2F-D8.0		8	8	20	60	2	B	●
GM-2F-D9.0		9	10	22	75	2	A	○
GM-2F-D10.0		10	10	25	75	2	B	○
GM-2F-D11.0		11	12	26	75	2	A	○
GM-2F-D12.0		12	12	30	75	2	B	●
GM-2F-D14.0		14	14	32	75	2	B	○
GM-2F-D16.0		16	16	45	100	2	B	○
GM-2F-D18.0		18	18	45	100	2	B	○
GM-2F-D20.0		20	20	45	100	2	B	○

● Ex stock ○ On demand

* With internal cooling

Application field					
P	M	K	N	S	H
✓	✓	✓			

✓ Very suitable

✓ Suitable

System code > B278

Cutting data > B492

Nonstandard order > B541



A

End mill long cutting edge Semi-finishing

GM-2FL

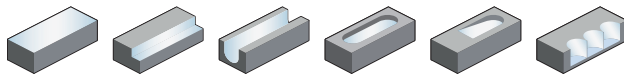

- Factory standard
- Centre cutting
- Helix angle 35°

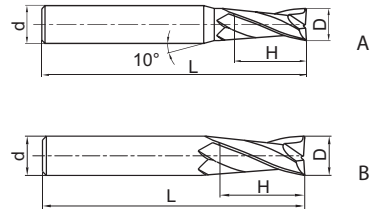

Turning

B

Milling

Article	*	Dimensions [mm]				Teeth	Geometry	Grade
		D	d (h6)	H	L			KMG303
GM-2FL-D3.0		3	6	12	75	2	A	○
GM-2FL-D4.0		4	6	15	75	2	A	○
GM-2FL-D5.0		5	6	20	75	2	A	○
GM-2FL-D6.0		6	6	20	75	2	B	○
GM-2FL-D8.0		8	8	25	100	2	B	○
GM-2FL-D10.0		10	10	30	100	2	B	○
GM-2FL-D12.0		12	12	35	100	2	B	○
GM-2FL-D14.0		14	14	40	100	2	B	○
GM-2FL-D16.0		16	16	50	150	2	B	○
GM-2FL-D20.0		20	20	55	150	2	B	○

● Ex stock ○ On demand

* With internal cooling

C

Drilling

Application field

P	M	K	N	S	H
✓	✓	✓			

✓ Very suitable

✓ Suitable

D

Technical Information

E

Index

System code > B278

Cutting data > B492

Nonstandard order > B541

End mill **Semi-finishing**

GM-2EP

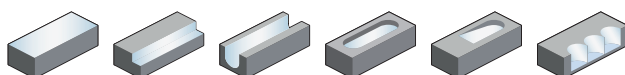

- Factory standard
- Centre cutting
- Helix angle 35°

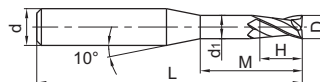

Article	*	Dimensions [mm]						Teeth	Grade
		D	d (h6)	d ₁	H	M	L		KMG303
GM-2EP-D0.5-M04		0.5	4	0.45	0.7	4	50	2	●
GM-2EP-D0.5-M06		0.5	4	0.45	0.7	6	50	2	●
GM-2EP-D0.5-M08		0.5	4	0.45	0.7	8	50	2	●
GM-2EP-D0.8-M04		0.8	4	0.75	1.2	4	50	2	●
GM-2EP-D0.8-M06		0.8	4	0.75	1.2	6	50	2	●
GM-2EP-D0.8-M08		0.8	4	0.75	1.2	8	50	2	●
GM-2EP-D0.8-M10		0.8	4	0.75	1.2	10	50	2	●
GM-2EP-D1.0-M04		1	4	0.95	1.5	4	50	2	●
GM-2EP-D1.0-M06		1	4	0.95	1.5	6	50	2	●
GM-2EP-D1.0-M08		1	4	0.95	1.5	8	50	2	●
GM-2EP-D1.0-M10		1	4	0.95	1.5	10	50	2	●
GM-2EP-D1.0-M12		1	4	0.95	1.5	12	50	2	●
GM-2EP-D1.0-M14		1	4	0.95	1.5	14	50	2	●
GM-2EP-D1.2-M06		1.2	4	1.15	1.8	6	50	2	●
GM-2EP-D1.2-M08		1.2	4	1.15	1.8	8	50	2	●
GM-2EP-D1.2-M10		1.2	4	1.15	1.8	10	50	2	●
GM-2EP-D1.2-M12		1.2	4	1.15	1.8	12	50	2	○
GM-2EP-D1.5-M06		1.5	4	1.45	2.3	6	50	2	●
GM-2EP-D1.5-M08		1.5	4	1.45	2.3	8	50	2	●
GM-2EP-D1.5-M10		1.5	4	1.45	2.3	10	50	2	●
GM-2EP-D1.5-M12		1.5	4	1.45	2.3	12	50	2	●
GM-2EP-D1.5-M14		1.5	4	1.45	2.3	14	50	2	●
GM-2EP-D2.0-M06		2	4	1.95	3	6	50	2	●
GM-2EP-D2.0-M08		2	4	1.95	3	8	50	2	●
GM-2EP-D2.0-M10		2	4	1.95	3	10	50	2	●
GM-2EP-D2.0-M12		2	4	1.95	3	12	50	2	●
GM-2EP-D2.0-M14		2	4	1.95	3	14	50	2	●
GM-2EP-D2.0-M16		2	4	1.95	3	16	50	2	●
GM-2EP-D2.5-M08		2.5	4	2.4	3.7	8	50	2	●
GM-2EP-D2.5-M10		2.5	4	2.4	3.7	10	50	2	●
GM-2EP-D2.5-M12		2.5	4	2.4	3.7	12	50	2	●
GM-2EP-D2.5-M14		2.5	4	2.4	3.7	14	50	2	●
GM-2EP-D2.5-M16		2.5	4	2.4	3.7	16	60	2	●
GM-2EP-D2.5-M18		2.5	4	2.4	3.7	18	60	2	●
GM-2EP-D2.5-M20		2.5	4	2.4	3.7	20	60	2	●
GM-2EP-D3.0-M06		3	6	2.85	4.5	6	50	2	●
GM-2EP-D3.0-M08		3	6	2.85	4.5	8	50	2	●

● Ex stock ○ On demand

* With internal cooling

Application field					
P	M	K	N	S	H
✓	✓	✓			

✓ Very suitable

✓ Suitable

System code > B278 Cutting data > B492 Nonstandard order > B541



A

Turning

B

Milling

C

Drilling

D

Technical Information

E

Index

A

End mill Semi-finishing

GM-2EP

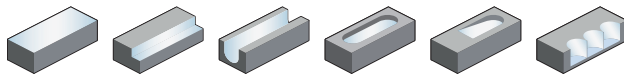

- Factory standard
- Centre cutting
- Helix angle 35°

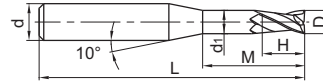

Turning

B

Article	*	Dimensions [mm]						Teeth	Grade
		D	d (h6)	d ₁	H	M	L		KMG303
GM-2EP-D3.0-M10		3	6	2.85	4.5	10	50	2	●
GM-2EP-D3.0-M12		3	6	2.85	4.5	12	50	2	●
GM-2EP-D3.0-M14		3	6	2.85	4.5	14	60	2	●
GM-2EP-D3.0-M16		3	6	2.85	4.5	16	60	2	●
GM-2EP-D3.0-M18		3	6	2.85	4.5	18	60	2	●
GM-2EP-D3.0-M20		3	6	2.85	4.5	20	60	2	●
GM-2EP-D4.0-M12		4	6	3.85	6	12	50	2	●
GM-2EP-D4.0-M14		4	6	3.85	6	14	60	2	●
GM-2EP-D4.0-M16		4	6	3.85	6	16	60	2	●
GM-2EP-D4.0-M20		4	6	3.85	6	20	60	2	●
GM-2EP-D4.0-M25		4	6	3.85	6	25	60	2	●
GM-2EP-D5.0-M16		5	6	4.85	7.5	16	60	2	●
GM-2EP-D5.0-M25		5	6	4.85	7.5	25	70	2	●

● Ex stock ○ On demand

* With internal cooling

Milling

C

Application field

P	M	K	N	S	H
✓	✓	✓			

✓ Very suitable

✓ Suitable

Drilling

D

Technical Information

E

Index

System code > B278

Cutting data > B492

Nonstandard order > B541

Schaftfräser

Semi-finishing

GM-2ES

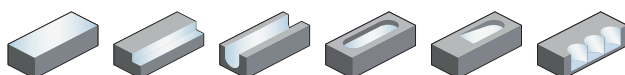

- Factory standard
- Centre cutting
- Helix angle 35°

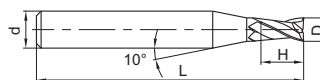

Article	*	Dimensions [mm]				Teeth	Grade
		D	d (h6)	H	L		KMG303
GM-2ES-D0.3		0.3	4	0.6	50	2	●
GM-2ES-D0.4		0.4	4	0.8	50	2	●
GM-2ES-D0.5		0.5	4	1	50	2	●
GM-2ES-D0.6		0.6	4	1.2	50	2	●
GM-2ES-D0.7		0.7	4	1.4	50	2	●
GM-2ES-D0.8		0.8	4	1.6	50	2	●
GM-2ES-D0.9		0.9	4	1.8	50	2	●
GM-2ES-D1.0		1	4	2	50	2	●
GM-2ES-D1.1		1.1	4	2	50	2	●
GM-2ES-D1.2		1.2	4	2.5	50	2	●
GM-2ES-D1.3		1.3	4	2.5	50	2	●
GM-2ES-D1.4		1.4	4	3	50	2	●
GM-2ES-D1.5		1.5	4	3	50	2	●
GM-2ES-D1.6		1.6	4	3.5	50	2	●
GM-2ES-D1.7		1.7	4	3.5	50	2	●
GM-2ES-D1.8		1.8	4	4	50	2	●
GM-2ES-D1.9		1.9	4	4	50	2	●
GM-2ES-D2.0		2	4	4	50	2	●
GM-2ES-D2.1		2.1	4	4	50	2	●
GM-2ES-D2.2		2.2	4	4.5	50	2	●
GM-2ES-D2.3		2.3	4	4.5	50	2	●
GM-2ES-D2.4		2.4	4	5	50	2	●
GM-2ES-D2.5		2.5	4	5	50	2	●
GM-2ES-D2.6		2.6	4	5	50	2	●
GM-2ES-D2.7		2.7	4	5.5	50	2	●
GM-2ES-D2.8		2.8	4	5.5	50	2	●
GM-2ES-D2.9		2.9	4	6	50	2	●
GM-2ES-D3.0		3	4	6	50	2	●

● Ex stock ○ On demand

* With internal cooling

Application field					
P	M	K	N	S	H
✓	✓	✓			

✓ Very suitable

✓ Suitable

System code > B278

Cutting data > B492

Nonstandard order > B541



A

End mill

Semi-finishing

GM-3E

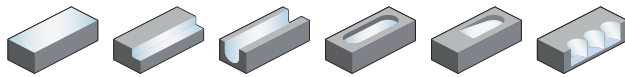

- Factory standard
- Centre cutting
- Helix angle 45°

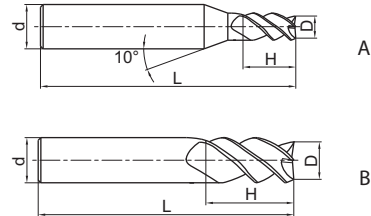

Turning

B

Milling

C

Drilling

D

Technical Information

E

Index

Article	*	Dimensions [mm]				Teeth	Geometry	Grade
		D	d (h6)	H	L			KMG303
GM-3E-D1.0S		1	4	3	50	3	A	○
GM-3E-D1.5S		1.5	4	4	50	3	A	○
GM-3E-D2.0S		2	4	6	50	3	A	○
GM-3E-D2.5S		2.5	4	8	50	3	A	○
GM-3E-D3.0S		3	4	8	50	3	A	○
GM-3E-D4.0S		4	4	11	50	3	B	○
GM-3E-D1.0		1	6	3	50	3	A	○
GM-3E-D1.5		1.5	6	4	50	3	A	○
GM-3E-D2.0		2	6	6	50	3	A	○
GM-3E-D2.5		2.5	6	8	50	3	A	○
GM-3E-D3.0		3	6	8	50	3	A	○
GM-3E-D3.5		3.5	6	10	50	3	A	○
GM-3E-D4.0		4	6	11	50	3	A	○
GM-3E-D4.5		4.5	6	11	50	3	A	○
GM-3E-D5.0		5	6	13	50	3	A	○
GM-3E-D5.5		5.5	6	16	50	3	A	○
GM-3E-D6.0		6	6	16	50	3	B	○
GM-3E-D7.0		7	8	20	60	3	A	○
GM-3E-D8.0		8	8	20	60	3	B	○
GM-3E-D9.0		9	10	22	75	3	A	○
GM-3E-D10.0		10	10	25	75	3	B	○
GM-3E-D11.0		11	12	26	75	3	A	○
GM-3E-D12.0		12	12	30	75	3	B	○
GM-3E-D14.0		14	14	32	75	3	B	○
GM-3E-D16.0		16	16	45	100	3	B	○
GM-3E-D18.0		18	18	45	100	3	B	○
GM-3E-D20.0		20	20	45	100	3	B	○

● Ex stock ○ On demand

* With internal cooling

Application field

P	M	K	N	S	H
✓	✓	✓			

✓ Very suitable

✓ Suitable

System code > B278

Cutting data > B492

Nonstandard order > B541

End mill long cutting edge

Semi-finishing

GM-3EL

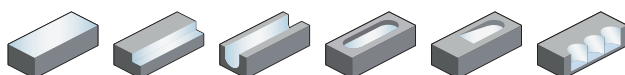

- Factory standard
- Centre cutting
- Helix angle 45°

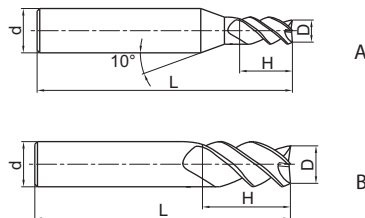

Article	*	Dimensions [mm]				Teeth	Geometry	Grade
		D	d (h6)	H	L			KMG303
GM-3EL-D3.0		3	6	12	75	3	A	●
GM-3EL-D4.0		4	6	15	75	3	A	●
GM-3EL-D5.0		5	6	20	75	3	A	●
GM-3EL-D6.0		6	6	20	75	3	B	●
GM-3EL-D8.0		8	8	25	100	3	B	●
GM-3EL-D10.0		10	10	30	100	3	B	●
GM-3EL-D12.0		12	12	35	100	3	B	●
GM-3EL-D14.0		14	14	40	100	3	B	●
GM-3EL-D16.0		16	16	50	150	3	B	●
GM-3EL-D20.0		20	20	55	150	3	B	●

● Ex stock ○ On demand

* With internal cooling

Application field					
P	M	K	N	S	H
✓	✓	✓			

✓ Very suitable

✓ Suitable

A

Turning

B

Milling

C

Drilling

D

Technical Information

E

Index

System code > B278

Cutting data > B492

Nonstandard order > B541

A

End mill Semi-finishing

5501R303GM

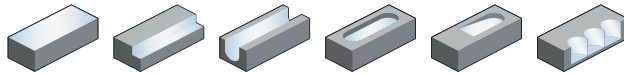

- Type of shank DIN 6535HA
- Centre cutting
- Helix angle 30°

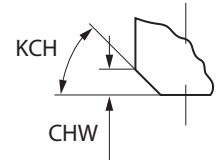
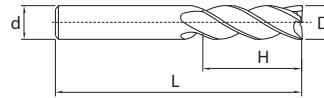

Turning

B

Article	*	Dimensions [mm]						Teeth	Grade	
		D	d (h6)	H	L	KCH	CHW		KMG303	YK30F
5501R303GM-0300		3	6	4	50	0	0	3	●	○
5501R303GM-0400		4	6	5	54	0	0	3	●	○
5501R303GM-0500		5	6	6	54	0	0	3	●	○
5501R303GM-0600		6	6	7	54	45	0.1	3	●	○
5501R303GM-0800		8	8	9	58	45	0.1	3	●	○
5501R303GM-1000		10	10	11	66	45	0.1	3	●	○
5501R303GM-1200		12	12	12	73	45	0.1	3	●	○
5501R303GM-1400		14	14	14	75	45	0.15	3	●	○
5501R303GM-1600		16	16	16	82	45	0.15	3	●	○
5501R303GM-1800		18	18	18	84	45	0.15	3	●	○
5501R303GM-2000		20	20	20	92	45	0.15	3	●	○

● Ex stock ○ On demand

* With internal cooling

Milling

C

Application field

P	M	K	N	S	H
✓	✓	✓			

- ✓ Very suitable
- ✓ Suitable

Drilling

D

Technical Information

E

Index

System code > B278

Cutting data > B492

Nonstandard order > B541

End mill **Semi-finishing**

5601R303GM

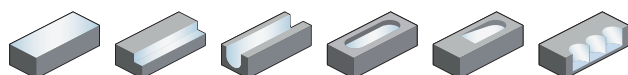

- Type of shank: DIN 6535HB
- Centre cutting
- Helix angle 30°

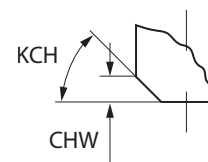
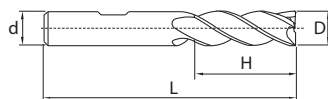
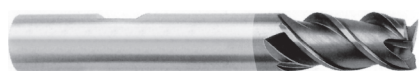

Article	*	Dimensions [mm]						Teeth	Grade
		D	d (h6)	H	L	KCH	CHW		KMG303
5601R303GM-0300		3	6	4	50	0	0	3	●
5601R303GM-0400		4	6	5	54	0	0	3	●
5601R303GM-0500		5	6	6	54	0	0	3	●
5601R303GM-0600		6	6	7	54	45	0.1	3	●
5601R303GM-0800		8	8	9	58	45	0.1	3	●
5601R303GM-1000		10	10	11	66	45	0.1	3	●
5601R303GM-1200		12	12	12	73	45	0.1	3	●
5601R303GM-1400		14	14	14	75	45	0.15	3	●
5601R303GM-1600		16	16	16	82	45	0.15	3	●
5601R303GM-1800		18	18	18	84	45	0.15	3	●
5601R303GM-2000		20	20	20	92	45	0.15	3	●

● Ex stock ○ On demand

* With internal cooling

Application field

P	M	K	N	S	H
✓	✓	✓			

✓ Very suitable

✓ Suitable

A

Turning

B

Milling

C

Drilling

D

Technical Information

E

Index

System code > B278

Cutting data > B492

Nonstandard order > B541



A

End mill long cutting edge Semi-finishing

5502R303GM

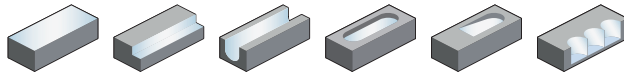

- Type of shank DIN 6535HA
- Centre cutting
- Helix angle 30°

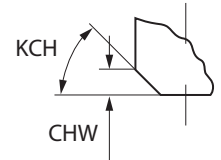
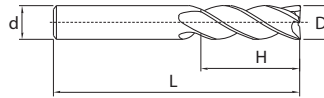

Turning

B

Article	*	Dimensions [mm]						Teeth	Grade	
		D	d (h6)	H	L	KCH	CHW		KMG303	YK30F
5502R303GM-0300		3	6	7	57	0	0	3	●	○
5502R303GM-0400		4	6	8	57	0	0	3	●	○
5502R303GM-0500		5	6	10	57	0	0	3	●	○
5502R303GM-0600		6	6	10	57	45	0.1	3	●	○
5502R303GM-0800		8	8	16	63	45	0.1	3	●	○
5502R303GM-1000		10	10	19	72	45	0.1	3	●	○
5502R303GM-1200		12	12	22	83	45	0.1	3	●	○
5502R303GM-1300		13	14	22	83	45	0.1	3	○	○
5502R303GM-1400		14	14	22	83	45	0.15	3	●	○
5502R303GM-1600		16	16	26	92	45	0.15	3	●	○
5502R303GM-1800		18	18	26	92	45	0.15	3	●	○
5502R303GM-2000		20	20	32	104	45	0.15	3	●	○

Milling

C

- Ex stock ○ On demand
- * With internal cooling

Drilling

D

Application field

P	M	K	N	S	H
✓	✓	✓			

- ✓ Very suitable
- ✓ Suitable

Technical Information

E

Index

System code > B278

Cutting data > B492

Nonstandard order > B541

End mill long cutting edge **Semi-finishing**

5602R303GM

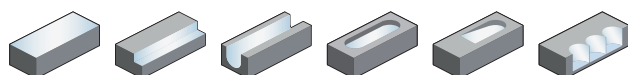

- Type of shank: DIN 6535HB
- Centre cutting
- Helix angle 30°

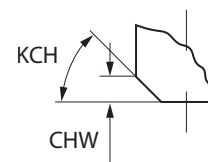
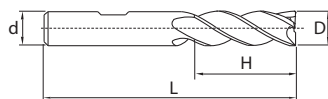

Article	*	Dimensions [mm]						Teeth	Grade
		D	d (h6)	H	L	KCH	CHW		KMG303
5602R303GM-0300		3	6	7	57	0	0	3	●
5602R303GM-0400		4	6	8	57	0	0	3	●
5602R303GM-0500		5	6	10	57	0	0	3	●
5602R303GM-0600		6	6	10	57	45	0.1	3	●
5602R303GM-0800		8	8	16	63	45	0.1	3	●
5602R303GM-1000		10	10	19	72	45	0.1	3	●
5602R303GM-1200		12	12	22	83	45	0.1	3	●
5602R303GM-1400		14	14	22	83	45	0.15	3	●
5602R303GM-1600		16	16	26	92	45	0.15	3	●
5602R303GM-1800		18	18	26	92	45	0.15	3	●
5602R303GM-2000		20	20	32	104	45	0.15	3	●

● Ex stock ○ On demand

* With internal cooling

Application field					
P	M	K	N	S	H
✓	✓	✓			

- ✓ Very suitable
- ✓ Suitable

A

Turning

B

Milling

C

Drilling

D

Technical Information

E

Index

System code > B278

Cutting data > B492

Nonstandard order > B541

A

End mill long cutting edge Semi-finishing

5502R453GM

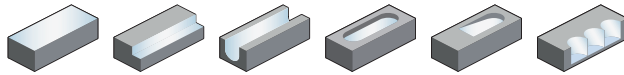

- Type of shank DIN 6535HA
- Centre cutting
- Helix angle 45°

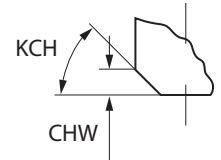
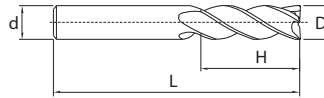

Turning

B

Article	*	Dimensions [mm]						Teeth	Grade
		D	d (h6)	H	L	KCH	CHW		KMG405
5502R453GM-0300		3	6	7	57	0	0	3	●
5502R453GM-0400		4	6	8	57	0	0	3	●
5502R453GM-0500		5	6	10	57	0	0	3	●
5502R453GM-0600		6	6	10	57	45	0.1	3	●
5502R453GM-0800		8	8	16	63	45	0.1	3	●
5502R453GM-1000		10	10	19	72	45	0.1	3	●
5502R453GM-1200		12	12	22	83	45	0.1	3	●
5502R453GM-1400		14	14	22	83	45	0.15	3	●
5502R453GM-1600		16	16	26	92	45	0.15	3	●
5502R453GM-1800		18	18	26	92	45	0.15	3	●
5502R453GM-2000		20	20	32	104	45	0.15	3	●

● Ex stock ○ On demand

* With internal cooling

Milling

C

Application field

P	M	K	N	S	H
✓	✓	✓			

- ✓ Very suitable
- ✓ Suitable

Drilling

D

Technical Information

E

Index

System code > B278

Cutting data > B492

Nonstandard order > B541

End mill long cutting edge **Semi-finishing**

5602R453GM

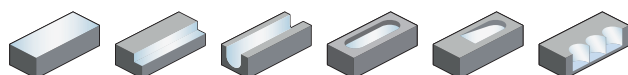

- Type of shank: DIN 6535HB
- Centre cutting
- Helix angle 45°

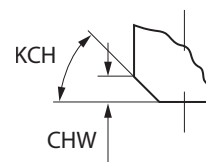
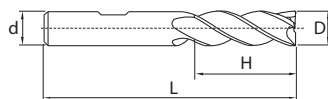
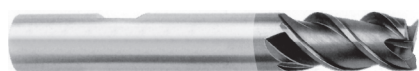

Article	*	Dimensions [mm]						Teeth	Grade	
		D	d (h6)	H	L	KCH	CHW		KMG303	KMG405
5602R453GM-0300		3	6	7	57	0	0	3	○	●
5602R453GM-0400		4	6	8	57	0	0	3	○	●
5602R453GM-0500		5	6	10	57	0	0	3	○	●
5602R453GM-0600		6	6	10	57	45	0.1	3	○	●
5602R453GM-0800		8	8	16	63	45	0.1	3	○	●
5602R453GM-1000		10	10	19	72	45	0.1	3	○	●
5602R453GM-1200		12	12	22	83	45	0.1	3	○	●
5602R453GM-1400		14	14	22	83	45	0.15	3	○	●
5602R453GM-1600		16	16	26	92	45	0.15	3	○	●
5602R453GM-1800		18	18	26	92	45	0.15	3	○	●
5602R453GM-2000		20	20	32	104	45	0.15	3	○	●

● Ex stock ○ On demand

* With internal cooling

Application field					
P	M	K	N	S	H
✓	✓	✓			

✓ Very suitable

✓ Suitable

System code > B278

Cutting data > B492

Nonstandard order > B541



A

End mill

Semi-finishing

GM-4F-G

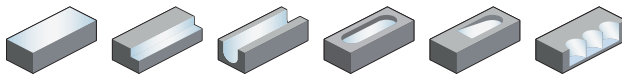

- Factory standard
- Centre cutting
- Helix angle 30°

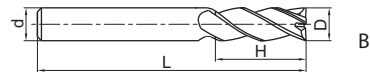
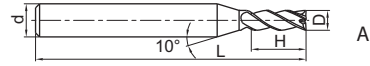

Turning

B

Milling

C

Drilling

D

Technical Information

Article	*	Dimensions [mm]				Teeth	Geometry	Grade
		D	d (h6)	H	L			KMG303
GM-4F-D2.0S-G		2	4	6	50	4	A	○
GM-4F-D2.5S-G		2.5	4	8	50	4	A	○
GM-4F-D4.0S-G		4	4	11	50	4	B	○
GM-4F-D1.0-G		1	6	3	50	4	A	○
GM-4F-D1.5-G		1.5	6	4	50	4	A	○
GM-4F-D2.0-G		2	6	6	50	4	A	○
GM-4F-D2.5-G		2.5	6	8	50	4	A	○
GM-4F-D3.0-G		3	6	8	50	4	A	○
GM-4F-D3.5-G		3.5	6	10	50	4	A	○
GM-4F-D4.0-G		4	6	11	50	4	A	○
GM-4F-D4.5-G		4.5	6	11	50	4	A	○
GM-4F-D5.0-G		5	6	13	50	4	A	○
GM-4F-D5.5-G		5.5	6	16	50	4	A	○
GM-4F-D6.0-G		6	6	16	50	4	B	○
GM-4F-D7.0-G		7	8	20	60	4	A	○
GM-4F-D8.0-G		8	8	20	60	4	B	○
GM-4F-D9.0-G		9	10	22	75	4	A	○
GM-4F-D10.0-G		10	10	25	75	4	B	○
GM-4F-D11.0-G		11	12	26	75	4	A	○
GM-4F-D12.0-G		12	12	30	75	4	B	○
GM-4F-D14.0-G		14	14	32	75	4	B	○
GM-4F-D16.0-G		16	16	45	100	4	B	○
GM-4F-D18.0-G		18	18	45	100	4	B	○
GM-4F-D20.0-G		20	20	45	100	4	B	○

● Ex stock ○ On demand

* With internal cooling

E

Index

Application field

P	M	K	N	S	H
✓	✓	✓			

✓ Very suitable

✓ Suitable

System code > B278

Cutting data > B492

Nonstandard order > B541

End mill long cutting edge

Semi-finishing

GM-4EL-G

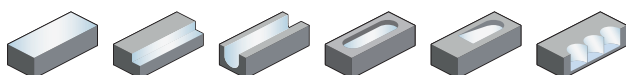

- Factory standard
- Centre cutting
- Helix angle 30°

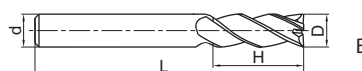
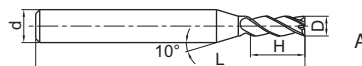

Article	*	Dimensions [mm]				Teeth	Geometry	Grade
		D	d (h6)	H	L			KMG303
GM-4EL-D3.0-G		3	6	12	75	4	A	○
GM-4EL-D4.0-G		4	6	15	75	4	A	○
GM-4EL-D5.0-G		5	6	20	75	4	A	○
GM-4EL-D6.0-G		6	6	20	75	4	B	○
GM-4EL-D8.0-G		8	8	25	100	4	B	○
GM-4EL-D10.0-G		10	10	30	100	4	B	○
GM-4EL-D12.0-G		12	12	35	100	4	B	○
GM-4EL-D14.0-G		14	14	40	100	4	B	○
GM-4EL-D16.0-G		16	16	50	150	4	B	○
GM-4EL-D20.0-G		20	20	55	150	4	B	○

● Ex stock ○ On demand

* With internal cooling

Application field					
P	M	K	N	S	H
✓	✓	✓			

✓ Very suitable

✓ Suitable

A

Turning

B

Milling

C

Drilling

D

Technical Information

E

Index

System code > B278

Cutting data > B492

Nonstandard order > B541

A

End mill long cutting edge Semi-finishing

GM-4FL-G

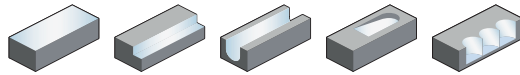

- Factory standard
- Centre cutting
- Helix angle 30°

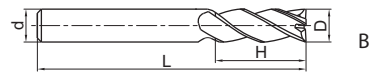
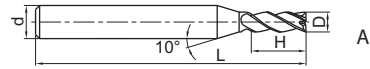

Turning

B

Milling

Article	*	Dimensions [mm]				Teeth	Geometry	Grade
		D	d (h6)	H	L			KMG303
GM-4FL-D3.0-G		3	6	12	75	4	A	○
GM-4FL-D4.0-G		4	6	15	75	4	A	○
GM-4FL-D5.0-G		5	6	20	75	4	A	●
GM-4FL-D6.0-G		6	6	20	75	4	B	●
GM-4FL-D8.0-G		8	8	25	100	4	B	●
GM-4FL-D10.0-G		10	10	30	100	4	B	●
GM-4FL-D12.0-G		12	12	35	100	4	B	●
GM-4FL-D14.0-G		14	14	40	100	4	B	○
GM-4FL-D16.0-G		16	16	50	150	4	B	○

● Ex stock ○ On demand

* With internal cooling

C

Drilling

Application field

P	M	K	N	S	H
✓	✓	✓			

✓ Very suitable

✓ Suitable

D

Technical Information

E

Index

System code > B278

Cutting data > B492

Nonstandard order > B541

End mill extra long cutting edge **Semi-finishing**

GM-4EX-G

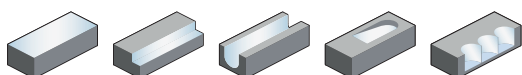

- Factory standard
- Centre cutting
- Helix angle 30°

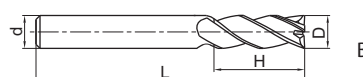
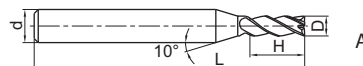

Article	*	Dimensions [mm]				Teeth	Geometry	Grade
		D	d (h6)	H	L			KMG303
GM-4EX-D3.0-G		3	6	20	75	4	A	●
GM-4EX-D4.0-G		4	6	25	75	4	A	●
GM-4EX-D5.0-G		5	6	30	75	4	A	●
GM-4EX-D6.0-G		6	6	30	75	4	B	●
GM-4EX-D8.0-G		8	8	40	100	4	B	●
GM-4EX-D10.0-G		10	10	50	110	4	B	●
GM-4EX-D12.0-G		12	12	50	110	4	B	●
GM-4EX-D16.0-G		16	16	70	150	4	B	●
GM-4EX-D20.0-G		20	20	75	150	4	B	●

● Ex stock ○ On demand

* With internal cooling

Application field					
P	M	K	N	S	H
✓	✓	✓			

- ✓ Very suitable
- ✓ Suitable

A

Turning

B

Milling

C

Drilling

D

Technical Information

E

Index

System code > B278

Cutting data > B492

Nonstandard order > B541

A

End mill

Semi-finishing

GM-4E

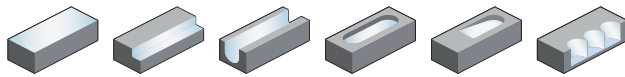

- Factory standard
- Centre cutting
- Helix angle 45°

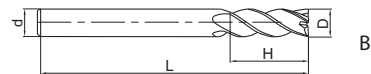
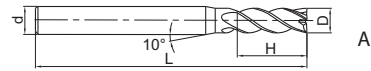

Turning

B

Milling

C

Drilling

D

Technical Information

E

Index

Article	*	Dimensions [mm]				Teeth	Geometry	Grade
		D	d (h6)	H	L			KMG303
GM-4E-D1.0S		1	4	3	50	4	A	●
GM-4E-D1.5S		1.5	4	4	50	4	A	●
GM-4E-D2.0S		2	4	6	50	4	A	●
GM-4E-D2.5S		2.5	4	8	50	4	A	●
GM-4E-D3.0S		3	4	8	50	4	A	●
GM-4E-D4.0S		4	4	11	50	4	B	●
GM-4E-D1.0		1	6	3	50	4	A	●
GM-4E-D1.5		1.5	6	4	50	4	A	●
GM-4E-D2.0		2	6	6	50	4	A	●
GM-4E-D2.5		2.5	6	8	50	4	A	●
GM-4E-D3.0		3	6	8	50	4	A	●
GM-4E-D3.5		3.5	6	10	50	4	A	●
GM-4E-D4.0		4	6	11	50	4	A	●
GM-4E-D4.5		4.5	6	11	50	4	A	●
GM-4E-D5.0		5	6	13	50	4	A	●
GM-4E-D5.5		5.5	6	16	50	4	A	●
GM-4E-D6.0		6	6	16	50	4	B	●
GM-4E-D7.0		7	8	20	60	4	A	●
GM-4E-D8.0		8	8	20	60	4	B	●
GM-4E-D9.0		9	10	22	75	4	A	●
GM-4E-D10.0		10	10	25	75	4	B	●
GM-4E-D11.0		11	12	26	75	4	A	●
GM-4E-D12.0		12	12	30	75	4	B	●
GM-4E-D14.0		14	14	32	75	4	B	●
GM-4E-D16.0		16	16	45	100	4	B	●
GM-4E-D18.0		18	18	45	100	4	B	●
GM-4E-D20.0		20	20	45	100	4	B	●

● Ex stock ○ On demand

* With internal cooling

Application field

P	M	K	N	S	H
✓	✓	✓			

✓ Very suitable

✓ Suitable

System code > B278

Cutting data > B492

Nonstandard order > B541

End mill **Semi-finishing**

GM-4E-G

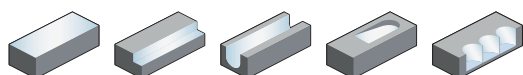

- Factory standard
- Centre cutting
- Helix angle 30°

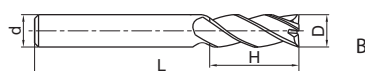
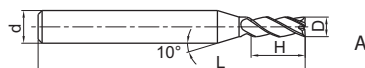

Article	*	Dimensions [mm]				Teeth	Geometry	Grade
		D	d (h6)	H	L			KMG303
GM-4E-D1.0S-G		1	4	3	50	4	A	●
GM-4E-D1.5S-G		1.5	4	4	50	4	A	●
GM-4E-D2.0S-G		2	4	6	50	4	A	●
GM-4E-D2.5S-G		2.5	4	8	50	4	A	●
GM-4E-D3.0S-G		3	4	8	50	4	A	●
GM-4E-D4.0S-G		4	4	11	50	4	B	●
GM-4E-D1.0-G		1	6	3	50	4	A	●
GM-4E-D1.5-G		1.5	6	4	50	4	A	●
GM-4E-D2.0-G		2	6	6	50	4	A	●
GM-4E-D2.5-G		2.5	6	8	50	4	A	●
GM-4E-D3.0-G		3	6	8	50	4	A	●
GM-4E-D3.5-G		3.5	6	10	50	4	A	●
GM-4E-D4.0-G		4	6	11	50	4	A	●
GM-4E-D4.5-G		4.5	6	11	50	4	A	○
GM-4E-D5.0-G		5	6	13	50	4	A	●
GM-4E-D5.5-G		5.5	6	16	50	4	A	●
GM-4E-D6.0-G		6	6	16	50	4	B	●
GM-4E-D7.0-G		7	8	20	60	4	A	●
GM-4E-D8.0-G		8	8	20	60	4	B	●
GM-4E-D9.0-G		9	10	22	75	4	A	●
GM-4E-D10.0-G		10	10	25	75	4	B	●
GM-4E-D11.0-G		11	12	26	75	4	A	●
GM-4E-D12.0-G		12	12	30	75	4	B	●
GM-4E-D14.0-G		14	14	32	75	4	B	●
GM-4E-D16.0-G		16	16	45	100	4	B	●
GM-4E-D18.0-G		18	18	45	100	4	B	●
GM-4E-D20.0-G		20	20	45	100	4	B	●

● Ex stock ○ On demand

* With internal cooling

Application field					
P	M	K	N	S	H
✓	✓	✓			

✓ Very suitable

✓ Suitable

System code > B278

Cutting data > B492

Nonstandard order > B541



A

End mill long cutting edge Semi-finishing

GM-4EL

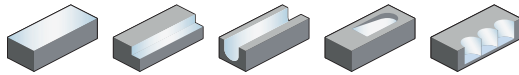

- Factory standard
- Centre cutting
- Helix angle 45°

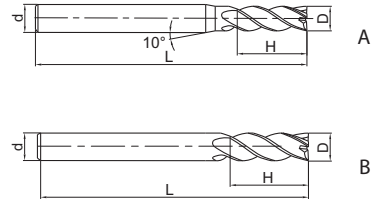

Turning

B

Milling

Article	*	Dimensions [mm]				Teeth	Geometry	Grade
		D	d (h6)	H	L			KMG303
GM-4EL-D3.0		3	6	12	75	4	A	●
GM-4EL-D4.0		4	6	15	75	4	A	●
GM-4EL-D5.0		5	6	20	75	4	A	●
GM-4EL-D6.0		6	6	20	75	4	B	●
GM-4EL-D8.0		8	8	25	100	4	B	●
GM-4EL-D10.0		10	10	30	100	4	B	●
GM-4EL-D12.0		12	12	35	100	4	B	●
GM-4EL-D14.0		14	14	40	100	4	B	●
GM-4EL-D16.0		16	16	50	150	4	B	●
GM-4EL-D20.0		20	20	55	150	4	B	●

● Ex stock ○ On demand

* With internal cooling

C

Drilling

Application field

P	M	K	N	S	H
✓	✓	✓			

✓ Very suitable

✓ Suitable

D

Technical Information

E

Index

System code > B278

Cutting data > B492

Nonstandard order > B541

End mill short cutting edge **Semi-finishing**

GM-4EFP

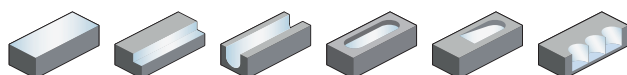

- Factory standard
- Centre cutting
- Helix angle 45°

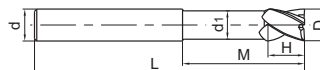

Article	*	Dimensions [mm]						Teeth	Grade
		D	d (h6)	d ₁	H	M	L		KMG303
GM-4EFP-D6.0		6	6	5.8	9	30	75	4	○
GM-4EFP-D8.0		8	8	7.8	12	40	100	4	○
GM-4EFP-D10.0		10	10	9.6	15	50	100	4	○
GM-4EFP-D12.0		12	12	11.5	18	50	100	4	○
GM-4EFP-D16.0		16	16	15.5	24	50	150	4	○
GM-4EFP-D20.0		20	20	19.5	30	60	150	4	○

● Ex stock ○ On demand

* With internal cooling

Application field					
P	M	K	N	S	H
✓	✓	✓			

✓ Very suitable

✓ Suitable

A

Turning

B

Milling

C

Drilling

D

Technical Information

E

Index

System code > B278

Cutting data > B492

Nonstandard order > B541



A

End mill Finishing

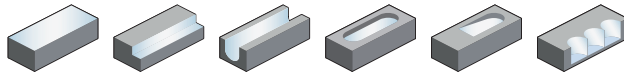

5501R304GF

- Type of shank DIN 6535HA
- Centre cutting
- Helix angle 30°

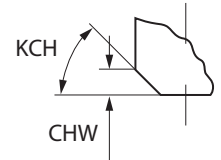
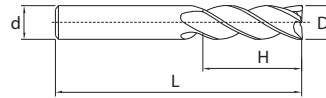

Turning

B

Article	*	Dimensions [mm]						Teeth	Grade	
		D	d (h6)	H	L	KCH	CHW		KMG303	YK30F
5501R304GF-0300		3	6	5	50	0	0	4	●	○
5501R304GF-0400		4	6	8	54	0	0	4	●	○
5501R304GF-0500		5	6	9	54	0	0	4	●	○
5501R304GF-0600		6	6	10	54	45	0.1	4	●	○
5501R304GF-0800		8	8	12	58	45	0.1	4	●	○
5501R304GF-1000		10	10	14	66	45	0.1	4	●	○
5501R304GF-1200		12	12	16	73	45	0.1	4	●	○
5501R304GF-1400		14	14	18	75	45	0.15	4	●	○
5501R304GF-1600		16	16	22	82	45	0.15	4	●	○
5501R304GF-1800		18	18	24	84	45	0.15	4	●	○
5501R304GF-2000		20	20	26	92	45	0.15	4	●	○

● Ex stock ○ On demand

* With internal cooling

Milling

C

Application field

P	M	K	N	S	H
✓	✓	✓			

✓ Very suitable

✓ Suitable

Drilling

D

Technical Information

E

Index

System code > B278

Cutting data > B492

Nonstandard order > B541

End mill **Finishing**

5601R304GF

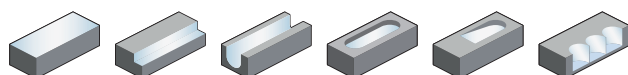

- Type of shank: DIN 6535HB
- Centre cutting
- Helix angle 30°

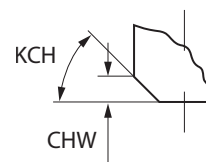
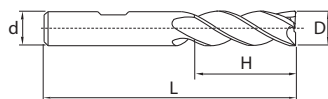
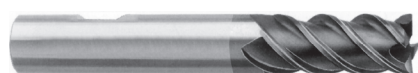

Article	*	Dimensions [mm]						Teeth	Grade
		D	d (h6)	H	L	KCH	CHW		KMG303
5601R304GF-0300		3	6	5	50	0	0	4	●
5601R304GF-0400		4	6	8	54	0	0	4	●
5601R304GF-0500		5	6	9	54	0	0	4	●
5601R304GF-0600		6	6	10	54	45	0.1	4	●
5601R304GF-0800		8	8	12	58	45	0.1	4	●
5601R304GF-1000		10	10	14	66	45	0.1	4	●
5601R304GF-1200		12	12	16	73	45	0.1	4	●
5601R304GF-1400		14	14	18	75	45	0.15	4	●
5601R304GF-1600		16	16	22	82	45	0.15	4	●
5601R304GF-1800		18	18	24	84	45	0.15	4	●
5601R304GF-2000		20	20	26	92	45	0.15	4	●

● Ex stock ○ On demand

* With internal cooling

Application field					
P	M	K	N	S	H
✓	✓	✓			

- ✓ Very suitable
- ✓ Suitable

A

Turning

B

Milling

C

Drilling

D

Technical Information

E

Index

System code > B278

Cutting data > B492

Nonstandard order > B541



A

End mill long cutting edge Finishing

5502R304GF

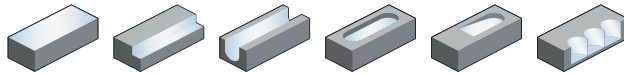

- Type of shank DIN 6535HA
- Centre cutting
- Helix angle 30°

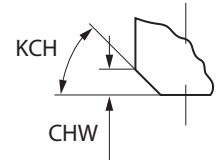
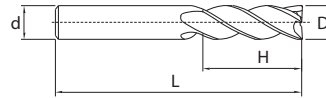

Turning

B

Article	*	Dimensions [mm]						Teeth	Grade	
		D	d (h6)	H	L	KCH	CHW		KMG303	YK30F
5502R304GF-0300		3	6	8	57	0	0	4	●	○
5502R304GF-0400		4	6	11	57	0	0	4	●	○
5502R304GF-0500		5	6	13	57	0	0	4	●	○
5502R304GF-0600		6	6	13	57	45	0.1	4	●	○
5502R304GF-0800		8	8	19	63	45	0.1	4	●	○
5502R304GF-1000		10	10	22	72	45	0.1	4	●	○
5502R304GF-1200		12	12	26	83	45	0.1	4	●	○
5502R304GF-1400		14	14	26	83	45	0.15	4	●	○
5502R304GF-1600		16	16	32	92	45	0.15	4	●	○
5502R304GF-1800		18	18	32	92	45	0.15	4	●	○
5502R304GF-2000		20	20	38	104	45	0.15	4	●	○

● Ex stock ○ On demand

* With internal cooling

Milling

C

Application field

P	M	K	N	S	H
✓	✓	✓			

✓ Very suitable

✓ Suitable

Drilling

D

Technical Information

E

Index

System code > B278

Cutting data > B492

Nonstandard order > B541

End mill long cutting edge

Finishing

5602R304GF

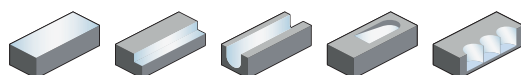

- Type of shank: DIN 6535HB
- Centre cutting
- Helix angle 30°

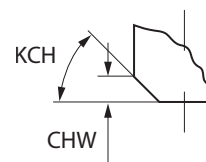
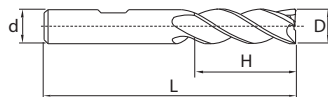
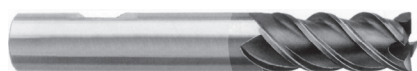

Article	*	Dimensions [mm]						Teeth	Grade	
		D	d (h6)	H	L	KCH	CHW		KMG303	YK30F
5602R304GF-0300		3	6	8	57	0	0	4	●	○
5602R304GF-0400		4	6	11	57	0	0	4	●	○
5602R304GF-0500		5	6	13	57	0	0	4	●	○
5602R304GF-0600		6	6	13	57	45	0.1	4	●	○
5602R304GF-0800		8	8	19	63	45	0.1	4	●	○
5602R304GF-1000		10	10	22	72	45	0.1	4	●	○
5602R304GF-1200		12	12	26	83	45	0.1	4	●	○
5602R304GF-1400		14	14	26	83	45	0.15	4	●	○
5602R304GF-1600		16	16	32	92	45	0.15	4	●	○
5602R304GF-1800		18	18	32	92	45	0.15	4	●	○
5602R304GF-2000		20	20	38	104	45	0.15	4	●	○

● Ex stock ○ On demand

* With internal cooling

Application field

P	M	K	N	S	H
✓	✓	✓			

✓ Very suitable

✓ Suitable

System code > B278

Cutting data > B492

Nonstandard order > B541



A

End mill long cutting edge Semi-finishing

5508R454GM

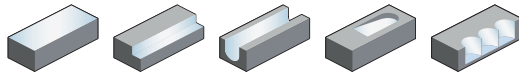

- Type of shank DIN 6535HA
- Centre cutting
- Helix angle 45°

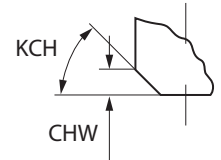
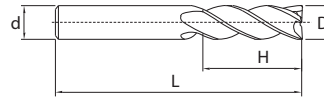

Turning

B

Article	*	Dimensions [mm]						Teeth	Grade	
		D	d (h6)	H	L	KCH	CHW		KMG303	YK30F
5508R454GM-0300		3	3	8	45	0	0	4	●	○
5508R454GM-0400		4	4	11	50	0	0	4	●	○
5508R454GM-0500		5	5	13	50	0	0	4	●	○
5508R454GM-0600		6	6	13	57	45	0.1	4	●	○
5508R454GM-0800		8	8	19	63	45	0.1	4	●	○
5508R454GM-1000		10	10	22	72	45	0.1	4	●	○
5508R454GM-1200		12	12	26	83	45	0.1	4	●	○
5508R454GM-1400		14	14	26	83	45	0.15	4	●	○
5508R454GM-1500		15	16	32	92	0	0	4	○	
5508R454GM-1600		16	16	32	92	45	0.15	4	●	○
5508R454GM-1800		18	18	32	92	45	0.15	4	●	○
5508R454GM-2000		20	20	38	104	45	0.15	4	●	○

● Ex stock ○ On demand

* With internal cooling

Milling

C

Application field

P	M	K	N	S	H
✓	✓	✓			

✓ Very suitable

✓ Suitable

Drilling

D

Technical Information

E

Index

System code > B278

Cutting data > B492

Nonstandard order > B541

End mill long cutting edge

Semi-finishing

5602R454GM

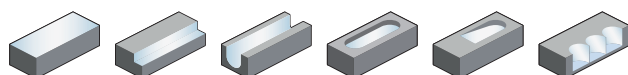

- Type of shank: DIN 6535HB
- Centre cutting
- Helix angle 45°

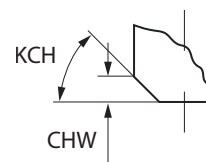
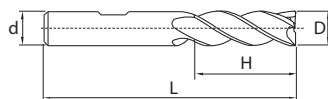
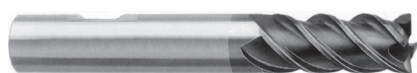

Article	*	Dimensions [mm]						Teeth	Grade
		D	d (h6)	H	L	KCH	CHW		KMG303
5602R454GM-0300		3	6	8	57	0	0	4	●
5602R454GM-0400		4	6	11	57	0	0	4	●
5602R454GM-0500		5	6	13	57	0	0	4	●
5602R454GM-0600		6	6	13	57	45	0.1	4	●
5602R454GM-0800		8	8	19	63	45	0.1	4	●
5602R454GM-1000		10	10	22	72	45	0.1	4	●
5602R454GM-1200		12	12	26	83	45	0.1	4	●
5602R454GM-1400		14	14	26	83	45	0.15	4	●
5602R454GM-1600		16	16	32	92	45	0.15	4	●
5602R454GM-1800		18	18	32	92	45	0.15	4	●
5602R454GM-2000		20	20	38	104	45	0.15	4	●

● Ex stock ○ On demand

* With internal cooling

Application field					
P	M	K	N	S	H
✓	✓	✓			

✓ Very suitable

✓ Suitable

System code > B278

Cutting data > B492

Nonstandard order > B541



A

Torus mill long cutting edge Finishing

Turning

5589R45MGFR

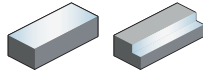

- Type of shank DIN 6535HA
- Helix angle 45°

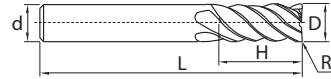

B

Milling

Article	*	Dimensions [mm]					Teeth	Grade
		D	R	d (h6)	H	L		KMG405
5589R45MGFR02-0600		6	0.2	6	19	63	6	●
5589R45MGFR02-0800		8	0.2	8	28	72	6	●
5589R45MGFR02-1000		10	0.2	10	34	84	6	●
5589R45MGFR02-1200		12	0.2	12	40	97	6	●

- Ex stock ○ On demand
- * With internal cooling

C

Drilling

Application field

P	M	K	N	S	H
✓	✓	✓			

- ✓ Very suitable
- ✓ Suitable

D

Technical Information

E

Index

System code > B278

Cutting data > B492

Nonstandard order > B541

End mill **Semi-finishing**

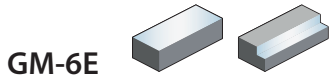

- Factory standard
- Non-centre cutting
- Helix angle 45°

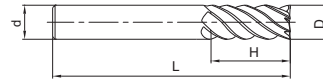

Article	*	Dimensions [mm]				Teeth	Grade
		D	d (h6)	H	L		KMG303
GM-6E-D6.0		6	6	18	60	6	●
GM-6E-D8.0		8	8	20	60	6	●
GM-6E-D10.0		10	10	30	75	6	●
GM-6E-D12.0		12	12	32	75	6	●
GM-6E-D16.0		16	16	40	100	6	●
GM-6E-D20.0		20	20	45	100	6	●

- Ex stock ○ On demand
- * With internal cooling

Application field					
P	M	K	N	S	H
✓	✓	✓			

- ✓ Very suitable
- ✓ Suitable

A

Turning

B

Milling

C

Drilling

D

Technical Information

E

Index

System code > B278

Cutting data > B492

Nonstandard order > B541



A

End mill long cutting edge

Semi-finishing

GM-6EL

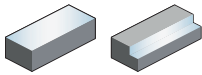

- Factory standard
- Non-centre cutting
- Helix angle 45°

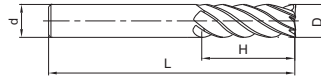

Turning

B

Article	*	Dimensions [mm]				Teeth	Grade
		D	d (h6)	H	L		KMG303
GM-6EL-D6.0		6	6	24	75	6	●
GM-6EL-D8.0		8	8	32	75	6	●
GM-6EL-D10.0		10	10	40	100	6	●
GM-6EL-D12.0		12	12	45	100	6	●
GM-6EL-D16.0		16	16	64	150	6	●
GM-6EL-D20.0		20	20	75	150	6	●

- Ex stock ○ On demand
- * With internal cooling

Milling

C

Application field					
P	M	K	N	S	H
✓	✓	✓			

- ✓ Very suitable
- ✓ Suitable

Drilling

D

Technical Information

E

Index

System code > B278

Cutting data > B492

Nonstandard order > B541

Ball nose cutter **Finishing**

5565R302GF

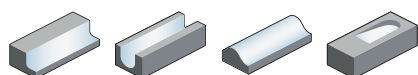

- Type of shank DIN 6535HA
- Centre cutting
- Helix angle 30°

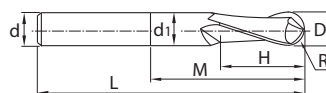

Article	*	Dimensions [mm]							Teeth	Grade
		D	R	d (h6)	d ₁	H	M	L		KMG303
5565R302GF-0300		3	1.5	6	2.8	4	9	57	2	●
5565R302GF-0400		4	2	6	3.7	5	12	57	2	●
5565R302GF-0500		5	2.5	6	4.6	6	15	57	2	●
5565R302GF-0600		6	3	6	5.5	7	20	57	2	●
5565R302GF-0800		8	4	8	7.4	9	26	63	2	●
5565R302GF-1000		10	5	10	9.2	11	31	72	2	●
5565R302GF-1200		12	6	12	11	12	37	83	2	●
5565R302GF-1600		16	8	16	15	16	43	92	2	●
5565R302GF-2000		20	10	20	19	20	50	104	2	●

● Ex stock ○ On demand

* With internal cooling

Application field					
P	M	K	N	S	H
✓	✓	✓			

✓ Very suitable

✓ Suitable

System code > B278

Cutting data > B492

Nonstandard order > B541



A

Ball nose cutter Semi-finishing

5665R202GM

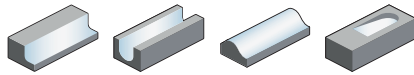

- Type of shank: DIN 6535HB
- Centre cutting
- Helix angle 20°

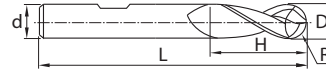

Turning

B

Article	*	Dimensions [mm]						Teeth	Grade
		D	R	d (h6)	d ₁	H	L		KMG303
5665R202GM-0300		3	1.5	6	2.8	4	57	2	●
5665R202GM-0400		4	2	6	3.7	5	57	2	●
5665R202GM-0500		5	2.5	6	4.6	6	57	2	●
5665R202GM-0600		6	3	6	5.5	7	57	2	●
5665R202GM-0800		8	4	8	7.4	9	63	2	●
5665R202GM-1000		10	5	10	9.2	11	72	2	●
5665R202GM-1200		12	6	12	11	12	83	2	●
5665R202GM-1600		16	8	16	15	16	92	2	●
5665R202GM-2000		20	10	20	19	20	104	2	●

● Ex stock ○ On demand

* With internal cooling

Milling

C

Application field

P	M	K	N	S	H
✓	✓	✓			

- ✓ Very suitable
- ✓ Suitable

Drilling

D

Technical Information

E

Index

System code > B278

Cutting data > B492

Nonstandard order > B541

Ball nose cutter long shank Finishing

5566R302GF

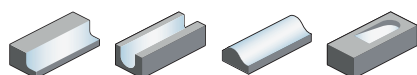

- Type of shank DIN 6535HA
- Centre cutting
- Helix angle 30°

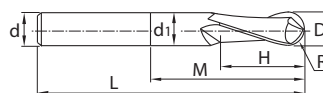

Article	*	Dimensions [mm]							Teeth	Grade
		D	R	d (h6)	d ₁	H	M	L		KMG303
5566R302GF-0300		3	1.5	6	2.8	4	15	75	2	●
5566R302GF-0400		4	2	6	3.7	5	20	75	2	●
5566R302GF-0500		5	2.5	6	4.6	6	25	80	2	●
5566R302GF-0600		6	3	6	5.5	7	60	80	2	●
5566R302GF-0800		8	4	8	7.4	9	65	90	2	●
5566R302GF-1000		10	5	10	9.2	11	40	100	2	●
5566R302GF-1200		12	6	12	11	12	50	120	2	●

● Ex stock ○ On demand

* With internal cooling

Application field					
P	M	K	N	S	H
✓	✓	✓			

✓ Very suitable

✓ Suitable

System code > B278

Cutting data > B492

Nonstandard order > B541



A

Ball nose cutter Semi-finishing

GM-2B

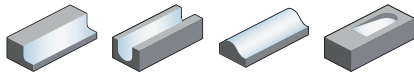

- Factory standard
- Centre cutting
- Helix angle 35°

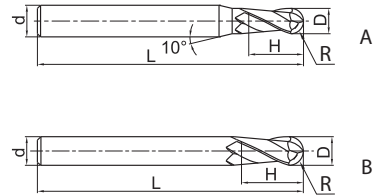

Turning

B

Milling

C

Drilling

D

Technical Information

Article	*	Dimensions [mm]					Teeth	Geometry	Grade
		R	D	d (h6)	H	L			KMG303
GM-2B-R0.5S		0.5	1	4	2	50	2	A	●
GM-2B-R0.75S		0.75	1.5	4	3	50	2	A	●
GM-2B-R1.0S		1	2	4	4	50	2	A	●
GM-2B-R1.25S		1.25	2.5	4	5	50	2	A	●
GM-2B-R1.5S		1.5	3	4	6	50	2	A	●
GM-2B-R2.0S		2	4	4	8	50	2	B	●
GM-2B-R0.5		0.5	1	6	2	50	2	A	○
GM-2B-R0.75		0.75	1.5	6	3	50	2	A	○
GM-2B-R1.0		1	2	6	4	50	2	A	●
GM-2B-R1.25		1.25	2.5	6	5	50	2	A	○
GM-2B-R1.5		1.5	3	6	6	50	2	A	●
GM-2B-R1.75		1.75	3.5	6	8	50	2	A	○
GM-2B-R2.0		2	4	6	8	50	2	A	●
GM-2B-R2.5		2.5	5	6	10	50	2	A	●
GM-2B-R2.75		2.75	5.5	6	12	50	2	A	○
GM-2B-R3.0		3	6	6	12	50	2	B	●
GM-2B-R3.5		3.5	7	8	14	60	2	A	○
GM-2B-R4.0		4	8	8	16	60	2	B	●
GM-2B-R4.5		4.5	9	10	18	75	2	A	○
GM-2B-R5.0		5	10	10	20	75	2	B	●
GM-2B-R6.0		6	12	12	24	75	2	B	●
GM-2B-R7.0		7	14	14	28	75	2	B	●
GM-2B-R8.0		8	16	16	32	100	2	B	●
GM-2B-R10.0		10	20	20	40	100	2	B	●

● Ex stock ○ On demand

* With internal cooling

E

Index

Application field

P	M	K	N	S	H
✓	✓	✓			

✓ Very suitable

✓ Suitable

System code > B278

Cutting data > B492

Nonstandard order > B541

Ball nose cutter long shank Semi-finishing

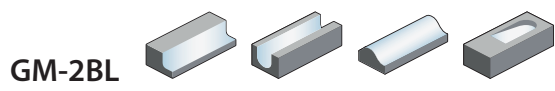

- Factory standard
- Centre cutting
- Helix angle 35°

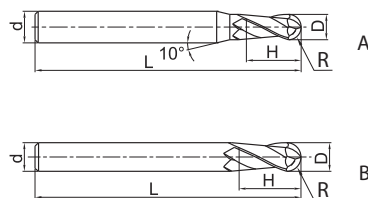

Article	*	Dimensions [mm]					Teeth	Geometry	Grade
		R	D	d (h6)	H	L			KMG303
GM-2BL-R1.0		1	2	6	4	75	2	A	●
GM-2BL-R1.25		1.25	2.5	6	5	75	2	A	●
GM-2BL-R1.5		1.5	3	6	6	75	2	A	●
GM-2BL-R1.75		1.75	3.5	6	8	75	2	A	●
GM-2BL-R2.0		2	4	6	8	75	2	A	●
GM-2BL-R2.5		2.5	5	6	10	75	2	A	●
GM-2BL-R2.75		2.75	5.5	6	12	75	2	A	●
GM-2BL-R3.0		3	6	6	12	75	2	B	●
GM-2BL-R3.5		3.5	7	8	14	75	2	A	●
GM-2BL-R4.0		4	8	8	16	100	2	B	●
GM-2BL-R4.5		4.5	9	10	18	100	2	A	●
GM-2BL-R5.0		5	10	10	20	100	2	B	●
GM-2BL-R6.0		6	12	12	24	100	2	B	●
GM-2BL-R7.0		7	14	14	28	100	2	B	●
GM-2BL-R8.0		8	16	16	32	150	2	B	●
GM-2BL-R10.0		10	20	20	40	150	2	B	●

● Ex stock ○ On demand

* With internal cooling

Application field					
P	M	K	N	S	H
✓	✓	✓			

✓ Very suitable

✓ Suitable

System code > B278

Cutting data > B492

Nonstandard order > B541



A

Ball nose cutter short cutting edge Semi-finishing

GM-2BFP

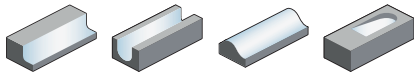

- Factory standard
- Centre cutting
- Helix angle 35°

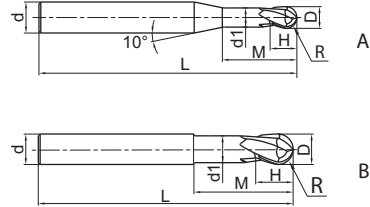

Turning

B

Milling

Article	*	Dimensions [mm]								Teeth	Geometry	Grade
		R	D	d (h6)	d ₁	H	M	L	KMG303			
GM-2BFP-R0.5		0.5	1	6	0.95	1	2.5	75	2	A	○	
GM-2BFP-R0.75		0.75	1.5	6	1.45	1	3	75	2	A	○	
GM-2BFP-R1.0		1	2	6	1.95	2	4	75	2	A	●	
GM-2BFP-R1.5		1.5	3	6	2.85	3	6	75	2	A	○	
GM-2BFP-R2.0		2	4	6	3.85	4	8	75	2	A	○	
GM-2BFP-R2.5		2.5	5	6	4.85	5	10	75	2	A	○	
GM-2BFP-R3.0		3	6	6	5.8	6	12	75	2	B	○	
GM-2BFP-R4.0		4	8	8	7.8	8	16	100	2	B	○	
GM-2BFP-R5.0		5	10	10	9.6	10	20	100	2	B	○	
GM-2BFP-R6.0		6	12	12	11.5	12	24	100	2	B	○	
GM-2BFP-R8.0		8	16	16	15.5	16	32	150	2	B	○	
GM-2BFP-R10.0		10	20	20	19.5	20	40	150	2	B	○	

● Ex stock ○ On demand

* With internal cooling

C

Drilling

D

Technical Information

Application field

P	M	K	N	S	H
✓	✓	✓			

✓ Very suitable

✓ Suitable

E

Index

System code > B278

Cutting data > B492

Nonstandard order > B541

Ball nose cutter **Semi-finishing**

GM-2BS

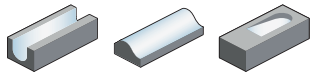

- Factory standard
- Centre cutting
- Helix angle 35°

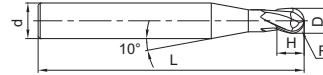

Article	*	Dimensions [mm]					Teeth	Grade
		R	D	d (h6)	H	L		KMG303
GM-2BS-R0.15		0.15	0.3	4	0.5	50	2	●
GM-2BS-R0.20		0.2	0.4	4	0.6	50	2	●
GM-2BS-R0.25		0.25	0.5	4	0.8	50	2	●
GM-2BS-R0.30		0.3	0.6	4	0.9	50	2	●
GM-2BS-R0.35		0.35	0.7	4	1	50	2	●
GM-2BS-R0.40		0.4	0.8	4	1.2	50	2	●
GM-2BS-R0.45		0.45	0.9	4	1.3	50	2	●
GM-2BS-R0.50		0.5	1	4	1.5	50	2	●
GM-2BS-R0.60		0.6	1.2	4	1.8	50	2	●
GM-2BS-R0.70		0.7	1.4	4	2	50	2	●
GM-2BS-R0.75		0.75	1.5	4	2.3	50	2	●
GM-2BS-R0.80		0.8	1.6	4	2.5	50	2	●
GM-2BS-R0.90		0.9	1.8	4	2.7	50	2	●
GM-2BS-R1.00		1	2	4	3	50	2	●
GM-2BS-R1.25		1.25	2.5	4	3.7	50	2	●
GM-2BS-R1.50		1.5	3	4	4.5	50	2	●

● Ex stock ○ On demand

* With internal cooling

Application field					
P	M	K	N	S	H
✓	✓	✓			

✓ Very suitable

✓ Suitable

System code > B278

Cutting data > B492

Nonstandard order > B541



A

Ball nose cutter Semi-finishing

GM-2BP

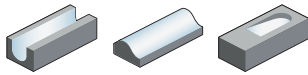

- Factory standard
- Centre cutting
- Helix angle 35°

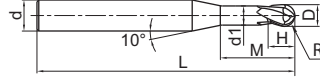

Turning

B

Article	*	Dimensions [mm]							Teeth	Grade KMG303
		R	D	d (h6)	d ₁	H	M	L		
GM-2BP-R0.25-M04		0.25	0.5	4	0.45	0.7	4	50	2	●
GM-2BP-R0.25-M06		0.25	0.5	4	0.45	0.7	6	50	2	●
GM-2BP-R0.3-M04		0.3	0.6	4	0.55	0.9	4	50	2	●
GM-2BP-R0.3-M06		0.3	0.6	4	0.55	0.9	6	50	2	●
GM-2BP-R0.3-M08		0.3	0.6	4	0.55	0.9	8	50	2	●
GM-2BP-R0.4-M04		0.4	0.8	4	0.75	1.2	4	50	2	●
GM-2BP-R0.4-M06		0.4	0.8	4	0.75	1.2	6	50	2	●
GM-2BP-R0.4-M08		0.4	0.8	4	0.75	1.2	8	50	2	●
GM-2BP-R0.4-M10		0.4	0.8	4	0.75	1.2	10	50	2	●
GM-2BP-R0.5-M04		0.5	1	4	0.95	1.5	4	50	2	●
GM-2BP-R0.5-M06		0.5	1	4	0.95	1.5	6	50	2	●
GM-2BP-R0.5-M08		0.5	1	4	0.95	1.5	8	50	2	●
GM-2BP-R0.5-M10		0.5	1	4	0.95	1.5	10	50	2	●
GM-2BP-R0.5-M12		0.5	1	4	0.95	1.5	12	50	2	●
GM-2BP-R0.6-M06		0.6	1.2	4	1.15	1.8	6	50	2	●
GM-2BP-R0.6-M08		0.6	1.2	4	1.15	1.8	8	50	2	●
GM-2BP-R0.6-M12		0.6	1.2	4	1.15	1.8	12	50	2	●
GM-2BP-R0.6-M16		0.6	1.2	4	1.15	1.8	16	50	2	●
GM-2BP-R0.75-M08		0.75	1.5	4	1.45	2.3	8	50	2	●
GM-2BP-R0.75-M12		0.75	1.5	4	1.45	2.3	12	50	2	●
GM-2BP-R0.75-M16		0.75	1.5	4	1.45	2.3	16	50	2	●
GM-2BP-R1.0-M06		1	2	4	1.95	3	6	50	2	●
GM-2BP-R1.0-M08		1	2	4	1.95	3	8	50	2	●
GM-2BP-R1.0-M10		1	2	4	1.95	3	10	50	2	●
GM-2BP-R1.0-M12		1	2	4	1.95	3	12	50	2	●
GM-2BP-R1.0-M16		1	2	4	1.95	3	16	50	2	●
GM-2BP-R1.0-M20		1	2	4	1.95	3	20	50	2	●
GM-2BP-R1.25-M08		1.25	2.5	4	2.4	3.7	8	50	2	●
GM-2BP-R1.25-M12		1.25	2.5	4	2.4	3.7	12	50	2	●
GM-2BP-R1.25-M16		1.25	2.5	4	2.4	3.7	16	60	2	●
GM-2BP-R1.25-M20		1.25	2.5	4	2.4	3.7	20	60	2	●
GM-2BP-R1.5-M08		1.5	3	6	2.85	4.5	8	50	2	●
GM-2BP-R1.5-M10		1.5	3	6	2.85	4.5	10	50	2	●
GM-2BP-R1.5-M12		1.5	3	6	2.85	4.5	12	50	2	●
GM-2BP-R1.5-M16		1.5	3	6	2.85	4.5	16	60	2	●
GM-2BP-R1.5-M20		1.5	3	6	2.85	4.5	20	60	2	●
GM-2BP-R2.0-M10		2	4	6	3.85	6	10	60	2	●

● Ex stock ○ On demand

* With internal cooling

C

Drilling

D

Technical Information

E

Index

Application field

P	M	K	N	S	H
✓	✓	✓			

✓ Very suitable

✓ Suitable

System code > B278

Cutting data > B492

Nonstandard order > B541

Ball nose cutter Semi-finishing

GM-2BP

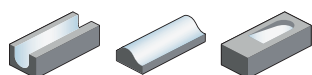

- Factory standard
- Centre cutting
- Helix angle 35°

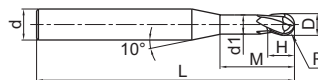

Article	*	Dimensions [mm]							Teeth	Grade
		R	D	d (h6)	d ₁	H	M	L		KMG303
GM-2BP-R2.0-M16		2	4	6	3.85	6	16	60	2	●
GM-2BP-R2.0-M20		2	4	6	3.85	6	20	60	2	●
GM-2BP-R2.0-M25		2	4	6	3.85	6	25	60	2	●
GM-2BP-R2.5-M16		2.5	5	6	4.85	7.5	16	60	2	●
GM-2BP-R2.5-M25		2.5	5	6	4.85	7.5	25	70	2	●

● Ex stock ○ On demand

* With internal cooling

Application field					
P	M	K	N	S	H
✓	✓	✓			

✓ Very suitable

✓ Suitable

A

Turning

B

Milling

C

Drilling

D

Technical Information

E

Index

System code > B278

Cutting data > B492

Nonstandard order > B541



A

Ball nose cutter **Semi-finishing**

GM-4B

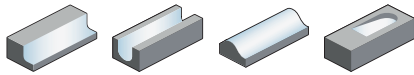

- Factory standard
- Centre cutting
- Helix angle 35°

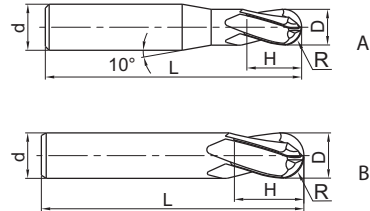

Turning

B

Milling

C

Drilling

Article	*	Dimensions [mm]					Teeth	Geometry	Grade
		R	D	d (h6)	H	L			KMG303
GM-4B-R1.5		1.5	3	6	6	50	4	A	●
GM-4B-R2.0		2	4	6	8	50	4	A	●
GM-4B-R2.5		2.5	5	6	10	50	4	A	●
GM-4B-R3.0		3	6	6	12	50	4	B	●
GM-4B-R4.0		4	8	8	16	60	4	B	●
GM-4B-R5.0		5	10	10	20	75	4	B	●
GM-4B-R6.0		6	12	12	24	75	4	B	●
GM-4B-R7.0		7	14	14	28	75	4	B	●
GM-4B-R8.0		8	16	16	32	100	4	B	●
GM-4B-R9.0		9	18	18	36	100	4	B	●
GM-4B-R10.0		10	20	20	40	100	4	B	●

● Ex stock ○ On demand

* With internal cooling

D

Technical Information

Application field

P	M	K	N	S	H
✓	✓	✓			

✓ Very suitable

✓ Suitable

F

Index

System code > B278

Cutting data > B492

Nonstandard order > B541

Ball nose cutter long shank Semi-finishing

GM-4BL

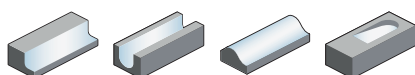

- Factory standard
- Centre cutting
- Helix angle 35°

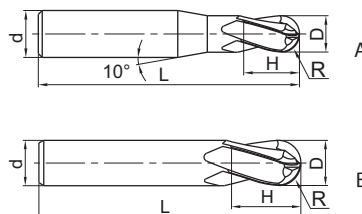

Article	*	Dimensions [mm]					Teeth	Geometry	Grade
		R	D	d (h6)	H	L			KMG303
GM-4BL-R1.5		1.5	3	6	6	75	4	A	○
GM-4BL-R2.0		2	4	6	8	75	4	A	○
GM-4BL-R2.5		2.5	5	6	10	75	4	A	○
GM-4BL-R3.0		3	6	6	12	75	4	B	○
GM-4BL-R4.0		4	8	8	16	100	4	B	○
GM-4BL-R5.0		5	10	10	20	100	4	B	○
GM-4BL-R6.0		6	12	12	24	100	4	B	○
GM-4BL-R7.0		7	14	14	28	100	4	B	○
GM-4BL-R8.0		8	16	16	32	150	4	B	○
GM-4BL-R10.0		10	20	20	40	150	4	B	○

● Ex stock ○ On demand

* With internal cooling

Application field					
P	M	K	N	S	H
✓	✓	✓			

✓ Very suitable

✓ Suitable

A

Turning

B

Milling

C

Drilling

D

Technical Information

E

Index

System code > B278

Cutting data > B492

Nonstandard order > B541

A

Torus mill

Semi-finishing

GM-2R

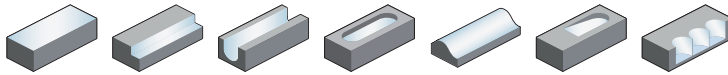

- Factory standard
- Centre cutting
- Helix angle 35°

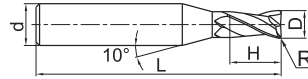

Turning

B

Article	*	Dimensions [mm]					Teeth	Grade
		R	D	d (h6)	H	L		KMG303
GM-2R-D1.0R0.2	*	0.2	1	4	3	50	2	○
GM-2R-D1.5R0.2	*	0.2	1.5	4	4	50	2	○
GM-2R-D2.0R0.2	*	0.2	2	4	6	50	2	○
GM-2R-D2.0R0.5	*	0.5	2	4	6	50	2	○
GM-2R-D2.5R0.2	*	0.2	2.5	4	8	50	2	○
GM-2R-D2.5R0.5	*	0.5	2.5	4	8	50	2	○
GM-2R-D3.0R0.2	*	0.2	3	4	8	50	2	○
GM-2R-D3.0R0.3	*	0.3	3	4	8	50	2	○
GM-2R-D3.0R0.5	*	0.5	3	4	8	50	2	○
GM-2R-D4.0R0.2	*	0.2	4	4	11	50	2	○
GM-2R-D4.0R0.3	*	0.3	4	4	11	50	2	○
GM-2R-D4.0R0.5	*	0.5	4	4	11	50	2	○
GM-2R-D4.0R1.0	*	1	4	4	11	50	2	○
GM-2R-D5.0R0.3	*	0.3	5	6	13	50	2	○
GM-2R-D5.0R0.5	*	0.5	5	6	13	50	2	○
GM-2R-D5.0R1.0	*	1	5	6	13	50	2	○
GM-2R-D6.0R0.3	*	0.3	6	6	16	50	2	○
GM-2R-D6.0R0.5	*	0.5	6	6	16	50	2	○
GM-2R-D6.0R1.0	*	1	6	6	16	50	2	○
GM-2R-D8.0R0.3	*	0.3	8	8	20	60	2	○
GM-2R-D8.0R0.5	*	0.5	8	8	20	60	2	○
GM-2R-D8.0R1.0	*	1	8	8	20	60	2	○
GM-2R-D10.0R0.5	*	0.5	10	10	25	75	2	○
GM-2R-D10.0R1.0	*	1	10	10	25	75	2	○
GM-2R-D10.0R1.5	*	1.5	10	10	25	75	2	●
GM-2R-D10.0R2.0	*	2	10	10	25	75	2	○
GM-2R-D12.0R0.5	*	0.5	12	12	30	75	2	○
GM-2R-D12.0R1.0	*	1	12	12	30	75	2	○
GM-2R-D12.0R1.5	*	1.5	12	12	30	75	2	○
GM-2R-D12.0R2.0	*	2	12	12	30	75	2	●

Milling

C

Drilling

D

Technical Information

- Ex stock ○ On demand
- * With internal cooling

E

Application field

P	M	K	N	S	H
✓	✓	✓			

- ✓ Very suitable
- ✓ Suitable

Index

System code > B278

Cutting data > B492

Nonstandard order > B541

Torus mill

Semi-finishing

GM-4R

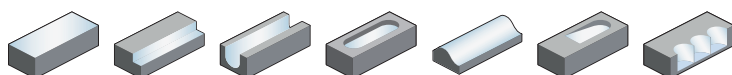

- Factory standard
- Centre cutting
- Helix angle 35°

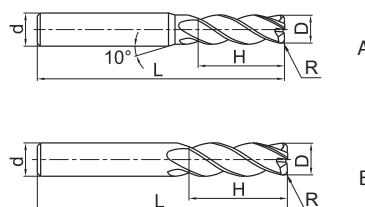

Article	*	Dimensions [mm]					Teeth	Geometry	Grade
		R	D	d (h6)	H	L			KMG303
GM-4R-D3.0R0.2		0.2	3	4	8	50	4	A	●
GM-4R-D4.0R0.3		0.3	4	4	10	50	4	B	○
GM-4R-D4.0R0.5		0.5	4	4	10	50	4	B	●
GM-4R-D5.0R0.5		0.5	5	6	13	50	4	A	●
GM-4R-D5.0R1.0		1	5	6	13	50	4	A	●
GM-4R-D6.0R0.5		0.5	6	6	16	50	4	B	●
GM-4R-D6.0R1.0		1	6	6	16	50	4	B	●
GM-4R-D8.0R0.5		0.5	8	8	20	60	4	B	●
GM-4R-D8.0R1.0		1	8	8	20	60	4	B	●
GM-4R-D10.0R0.5		0.5	10	10	25	75	4	B	●
GM-4R-D10.0R1.0		1	10	10	25	75	4	B	●
GM-4R-D10.0R2.0		2	10	10	25	75	4	B	●
GM-4R-D10.0R3.0		3	10	10	25	75	4	B	●
GM-4R-D12.0R0.5		0.5	12	12	30	75	4	B	●
GM-4R-D12.0R1.0		1	12	12	30	75	4	B	●
GM-4R-D12.0R2.0		2	12	12	30	75	4	B	●
GM-4R-D12.0R3.0		3	12	12	30	75	4	B	●

● Ex stock ○ On demand

* With internal cooling

Application field					
P	M	K	N	S	H
✓	✓	✓			

✓ Very suitable

✓ Suitable

System code > B278

Cutting data > B492

Nonstandard order > B541



A

Torus mill long shank Semi-finishing

GM-4RL

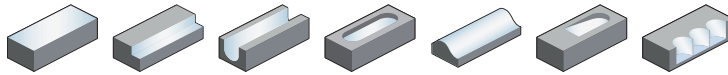

- Factory standard
- Centre cutting
- Helix angle 35°

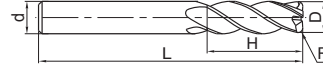

Turning

B

Article	*	Dimensions [mm]					Teeth	Grade
		R	D	d (h6)	H	L		KMG303
GM-4RL-D6.0R0.5	*	0.5	6	6	16	75	4	●
GM-4RL-D6.0R1.0		1	6	6	16	75	4	●
GM-4RL-D8.0R0.5	*	0.5	8	8	20	100	4	●
GM-4RL-D8.0R1.0		1	8	8	20	100	4	●
GM-4RL-D10.0R0.5	*	0.5	10	10	25	100	4	●
GM-4RL-D10.0R1.0		1	10	10	25	100	4	●
GM-4RL-D10.0R2.0		2	10	10	25	100	4	●
GM-4RL-D12.0R0.5	*	0.5	12	12	30	100	4	○
GM-4RL-D12.0R1.0		1	12	12	30	100	4	●
GM-4RL-D12.0R2.0		2	12	12	30	100	4	●
GM-4RL-D16.0R1.0		1	16	16	45	150	4	●
GM-4RL-D16.0R2.0		2	16	16	45	150	4	●

- Ex stock ○ On demand
- * With internal cooling

Milling

C

Application field						
P	M	K	N	S	H	
✓	✓	✓				✓ Very suitable
						✓ Suitable

Drilling

D

Technical Information

E

Index

System code > B278

Cutting data > B492

Nonstandard order > B541

End mill long cutting edge

General roughing

5602R303GR

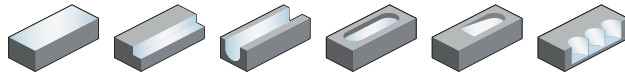

- Type of shank: DIN 6535HB
- Centre cutting
- Helix angle 30°

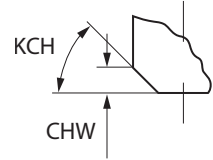
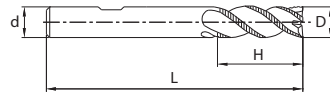

Article	*	Dimensions [mm]						Teeth	Grade
		D	d (h6)	H	L	KCH	CHW		KMG303
5602R303GR-0600		6	6	13	57	45	0.25	3	●
5602R303GR-0800		8	8	19	63	45	0.25	3	●

● Ex stock ○ On demand

* With internal cooling

Application field

P	M	K	N	S	H
✓	✓	✓			

✓ Very suitable

✓ Suitable

A

Turning

B

Milling

C

Drilling

D

Technical Information

E

Index

System code > B278

Cutting data > B492

Nonstandard order > B541

A

End mill long cutting edge General roughing

5602R304GR

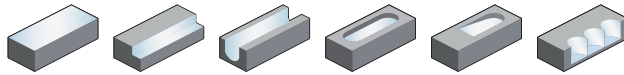

- Type of shank: DIN 6535HB
- Centre cutting
- Helix angle 30°

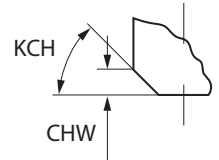
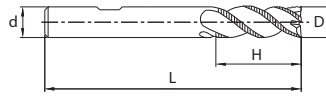

Turning

B

Article	*	Dimensions [mm]						Teeth	Grade
		D	d (h6)	H	L	KCH	CHW		KMG303
5602R304GR-1000		10	10	22	72	45	0.5	4	●
5602R304GR-1200		12	12	26	83	45	0.5	4	●
5602R304GR-1400		14	14	30	90	45	0.5	4	○
5602R304GR-1600		16	16	32	92	45	0.5	4	●
5602R304GR-2000		20	20	38	104	45	0.5	4	●

● Ex stock ○ On demand

* With internal cooling

Milling

C

Application field

P	M	K	N	S	H
✓	✓	✓			

✓ Very suitable

✓ Suitable

Drilling

D

Technical Information

E

Index

System code > B278

Cutting data > B492

Nonstandard order > B541

End mill long cutting edge

General roughing

5602R305GR

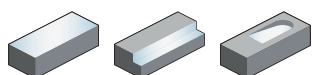

- Type of shank: DIN 6535HB
- Centre cutting
- Helix angle 30°

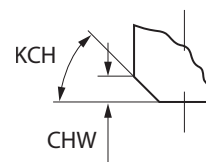
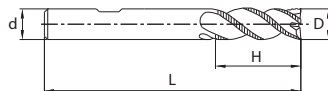
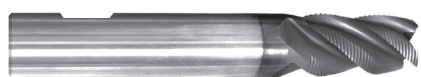

Article	*	Dimensions [mm]						Teeth	Grade
		D	d (h6)	H	L	KCH	CHW		KMG303
5602R305GR-2500		25	25	45	121	45	0.5	5	o

- Ex stock ○ On demand

* With internal cooling

Application field

P	M	K	N	S	H
✓	✓	✓			

- ✓ Very suitable
- ✓ Suitable

A

Turning

B

Milling

C

Drilling

D

Technical Information

E

Index

System code > B278

Cutting data > B492

Nonstandard order > B541



A

End mill serrated teeth Semi-finishing

GM-4W

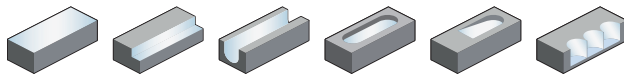

- Factory standard
- Centre cutting
- Helix angle 30°

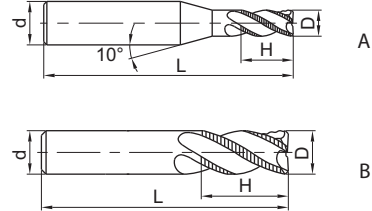

Turning

B

Milling

C

Drilling

Article	*	Dimensions [mm]				Teeth	Geometry	Grade
		D	d (h6)	H	L			KMG405
GM-4W-D6.0		6	6	16	50	4	B	●
GM-4W-D7.0		7	8	20	60	4	A	●
GM-4W-D8.0		8	8	20	60	4	B	●
GM-4W-D9.0		9	10	22	75	4	A	●
GM-4W-D10.0		10	10	25	75	4	B	●
GM-4W-D11.0		11	12	26	75	4	A	●
GM-4W-D12.0		12	12	30	75	4	B	●
GM-4W-D16.0		16	16	45	100	4	B	●
GM-4W-D20.0		20	20	45	100	4	B	●

● Ex stock ○ On demand

* With internal cooling

D

Technical Information

E

Index

Application field						
P	M	K	N	S	H	
✓	✓	✓				✓ Very suitable ✓ Suitable

System code > B278

Cutting data > B492

Nonstandard order > B541

End mill **High-performance machining**

PM-2E

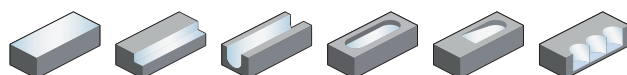

- Factory standard
- Centre cutting
- Helix angle 30°

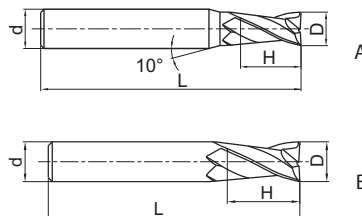

Article	*	Dimensions [mm]				Teeth	Geometry	Grade
		D	d (h6)	H	L			KMG405
PM-2E-D1.0S		1	4	3	50	2	A	●
PM-2E-D1.5S		1.5	4	4	50	2	A	●
PM-2E-D2.0S		2	4	6	50	2	A	●
PM-2E-D2.5S		2.5	4	8	50	2	A	●
PM-2E-D3.0S		3	4	8	50	2	A	●
PM-2E-D4.0S		4	4	11	50	2	B	●
PM-2E-D1.0		1	6	3	50	2	A	●
PM-2E-D1.5		1.5	6	4	50	2	A	●
PM-2E-D2.0		2	6	6	50	2	A	●
PM-2E-D2.5		2.5	6	8	50	2	A	●
PM-2E-D3.0		3	6	8	50	2	A	●
PM-2E-D3.5		3.5	6	10	50	2	A	●
PM-2E-D4.0		4	6	11	50	2	A	●
PM-2E-D4.5		4.5	6	11	50	2	A	●
PM-2E-D5.0		5	6	13	50	2	A	●
PM-2E-D5.5		5.5	6	16	50	2	A	●
PM-2E-D6.0		6	6	16	50	2	B	●
PM-2E-D7.0		7	8	20	60	2	A	●
PM-2E-D8.0		8	8	20	60	2	B	●
PM-2E-D9.0		9	10	22	75	2	A	●
PM-2E-D10.0		10	10	25	75	2	B	●
PM-2E-D11.0		11	12	26	75	2	A	○
PM-2E-D12.0		12	12	30	75	2	B	●
PM-2E-D14.0		14	14	32	75	2	B	●
PM-2E-D16.0		16	16	45	100	2	B	●
PM-2E-D18.0		18	18	45	100	2	B	○
PM-2E-D20.0		20	20	45	100	2	B	●

● Ex stock ○ On demand

* With internal cooling

Application field					
P	M	K	N	S	H
✓	✓	✓			✓

✓ Very suitable

✓ Suitable

System code > B278

Cutting data > B492

Nonstandard order > B541



A

Turning

B

Milling

C

Drilling

D

Technical Information

E

Index

A

End mill long cutting edge High-performance machining

PM-2EL

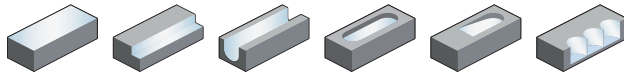

- Factory standard
- Centre cutting
- Helix angle 30°

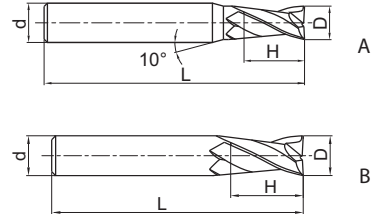

Turning

B

Milling

Article	*	Dimensions [mm]				Teeth	Geometry	Grade
		D	d (h6)	H	L			KMG405
PM-2EL-D3.0		3	6	12	75	2	A	●
PM-2EL-D4.0		4	6	15	75	2	A	●
PM-2EL-D5.0		5	6	20	75	2	A	●
PM-2EL-D6.0		6	6	20	75	2	B	●
PM-2EL-D8.0		8	8	25	100	2	B	●
PM-2EL-D10.0		10	10	30	100	2	B	●
PM-2EL-D12.0		12	12	35	100	2	B	●
PM-2EL-D14.0		14	14	40	100	2	B	○
PM-2EL-D16.0		16	16	50	150	2	B	●
PM-2EL-D20.0		20	20	55	150	2	B	●

● Ex stock ○ On demand

* With internal cooling

C

Drilling

Application field

P	M	K	N	S	H
✓	✓	✓			✓

✓ Very suitable

✓ Suitable

D

Technical Information

E

Index

System code > B278

Cutting data > B492

Nonstandard order > B541

End mill **High-performance machining**

PM-4E-G

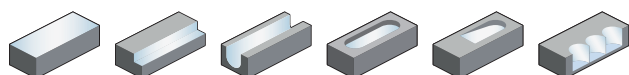

- Factory standard
- Centre cutting
- Helix angle 30°

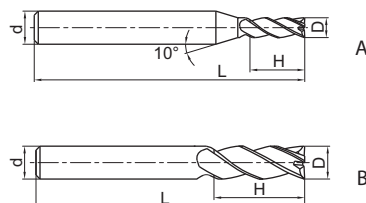

Article	*	Dimensions [mm]				Teeth	Geometry	Grade
		D	d (h6)	H	L			KMG405
PM-4E-D1.0S-G		1	4	3	50	4	A	●
PM-4E-D1.5S-G		1.5	4	4	50	4	A	●
PM-4E-D2.0S-G		2	4	6	50	4	A	●
PM-4E-D2.5S-G		2.5	4	8	50	4	A	●
PM-4E-D3.0S-G		3	4	8	50	4	A	●
PM-4E-D4.0S-G		4	4	11	50	4	B	●
PM-4E-D1.0-G		1	6	3	50	4	A	●
PM-4E-D1.5-G		1.5	6	4	50	4	A	●
PM-4E-D2.0-G		2	6	6	50	4	A	●
PM-4E-D2.5-G		2.5	6	8	50	4	A	●
PM-4E-D3.0-G		3	6	8	50	4	A	●
PM-4E-D3.5-G		3.5	6	10	50	4	A	●
PM-4E-D4.0-G		4	6	11	50	4	A	●
PM-4E-D4.5-G		4.5	6	11	50	4	A	●
PM-4E-D5.0-G		5	6	13	50	4	A	●
PM-4E-D5.5-G		5.5	6	16	50	4	A	●
PM-4E-D6.0-G		6	6	16	50	4	B	●
PM-4E-D7.0-G		7	8	20	60	4	A	●
PM-4E-D8.0-G		8	8	20	60	4	B	●
PM-4E-D9.0-G		9	10	22	75	4	A	●
PM-4E-D10.0-G		10	10	25	75	4	B	●
PM-4E-D11.0-G		11	12	26	75	4	A	●
PM-4E-D12.0-G		12	12	30	75	4	B	●
PM-4E-D14.0-G		14	14	32	75	4	B	●
PM-4E-D16.0-G		16	16	45	100	4	B	●
PM-4E-D18.0-G		18	18	45	100	4	B	●
PM-4E-D20.0-G		20	20	45	100	4	B	●

● Ex stock ○ On demand

* With internal cooling

Application field					
P	M	K	N	S	H
✓	✓	✓			✓

✓ Very suitable

✓ Suitable

System code > B278

Cutting data > B492

Nonstandard order > B541



A

End mill long cutting edge High-performance machining

PM-4EL-G

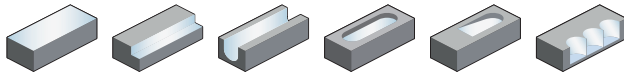

- Factory standard
- Centre cutting
- Helix angle 30°

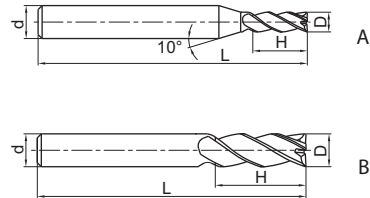
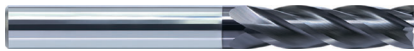

Turning

B

Milling

Article	*	Dimensions [mm]				Teeth	Geometry	Grade
		D	d (h6)	H	L			KMG405
PM-4EL-D3.0-G		3	6	12	75	4	A	○
PM-4EL-D4.0-G		4	6	15	75	4	A	○
PM-4EL-D5.0-G		5	6	20	75	4	A	○
PM-4EL-D6.0-G		6	6	20	75	4	B	○
PM-4EL-D8.0-G		8	8	25	100	4	B	○
PM-4EL-D10.0-G		10	10	30	100	4	B	○
PM-4EL-D12.0-G		12	12	35	100	4	B	○
PM-4EL-D14.0-G		14	14	40	100	4	B	○
PM-4EL-D16.0-G		16	16	50	150	4	B	○
PM-4EL-D20.0-G		20	20	55	150	4	B	○

● Ex stock ○ On demand

* With internal cooling

C

Drilling

Application field

P	M	K	N	S	H
✓	✓	✓			✓

✓ Very suitable

✓ Suitable

D

Technical Information

E

Index

System code > B278

Cutting data > B492

Nonstandard order > B541

End mill extra long cutting edge

High-performance machining

PM-4EX-G

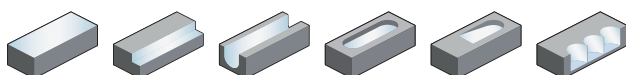

- Factory standard
- Centre cutting
- Helix angle 30°

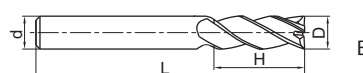
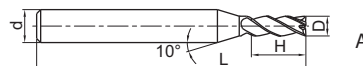

Article	*	Dimensions [mm]				Teeth	Geometry	Grade
		D	d (h6)	H	L			KMG405
PM-4EX-D3.0-G		3	6	20	75	4	A	●
PM-4EX-D4.0-G		4	6	25	75	4	A	●
PM-4EX-D5.0-G		5	6	30	75	4	A	●
PM-4EX-D6.0-G		6	6	30	75	4	B	●
PM-4EX-D8.0-G		8	8	40	100	4	B	●
PM-4EX-D10.0-G		10	10	50	110	4	B	●
PM-4EX-D12.0-G		12	12	50	110	4	B	●
PM-4EX-D16.0-G		16	16	70	150	4	B	●
PM-4EX-D20.0-G		20	20	75	150	4	B	●

● Ex stock ○ On demand

* With internal cooling

Application field					
P	M	K	N	S	H
✓	✓	✓			✓

- ✓ Very suitable
- ✓ Suitable

A

Turning

B

Milling

C

Drilling

D

Technical Information

E

Index

System code > B278

Cutting data > B492

Nonstandard order > B541



A

End mill High-performance machining

PM-4E

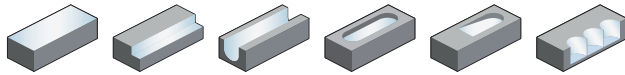

- Factory standard
- Centre cutting
- Helix angle 45°

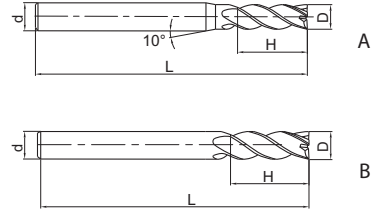

Turning

B

Milling

C

Drilling

D

Technical Information

Article	*	Dimensions [mm]				Teeth	Geometry	Grade
		D	d (h6)	H	L			KMG405
PM-4E-D1.0S		1	4	3	50	4	A	●
PM-4E-D1.5S		1.5	4	4	50	4	A	●
PM-4E-D2.0S		2	4	6	50	4	A	●
PM-4E-D2.5S		2.5	4	8	50	4	A	●
PM-4E-D3.0S		3	4	8	50	4	A	●
PM-4E-D4.0S		4	4	11	50	4	B	●
PM-4E-D1.0		1	6	3	50	4	A	●
PM-4E-D1.5		1.5	6	4	50	4	A	●
PM-4E-D2.0		2	6	6	50	4	A	●
PM-4E-D2.5		2.5	6	8	50	4	A	●
PM-4E-D3.0		3	6	8	50	4	A	●
PM-4E-D3.5		3.5	6	10	50	4	A	●
PM-4E-D4.0		4	6	11	50	4	A	●
PM-4E-D4.5		4.5	6	11	50	4	A	●
PM-4E-D5.0		5	6	13	50	4	A	●
PM-4E-D5.5		5.5	6	16	50	4	A	●
PM-4E-D6.0		6	6	16	50	4	B	●
PM-4E-D7.0		7	8	20	60	4	A	●
PM-4E-D8.0		8	8	20	60	4	B	●
PM-4E-D9.0		9	10	22	75	4	A	●
PM-4E-D10.0		10	10	25	75	4	B	●
PM-4E-D11.0		11	12	26	75	4	A	●
PM-4E-D12.0		12	12	30	75	4	B	●
PM-4E-D14.0		14	14	32	75	4	B	●
PM-4E-D16.0		16	16	45	100	4	B	●
PM-4E-D18.0		18	18	45	100	4	B	●
PM-4E-D20.0		20	20	45	100	4	B	●

● Ex stock ○ On demand

* With internal cooling

E

Index

Application field					
P	M	K	N	S	H
✓	✓	✓			✓

✓ Very suitable
 ✓ Suitable

System code > B278

Cutting data > B492

Nonstandard order > B541

End mill long cutting edge **High-performance machining**

PM-4EL

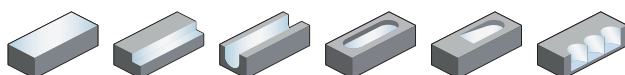

- Factory standard
- Centre cutting
- Helix angle 45°

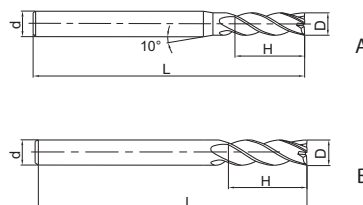

Article	*	Dimensions [mm]				Teeth	Geometry	Grade
		D	d (h6)	H	L			KMG405
PM-4EL-D3.0		3	6	12	75	4	A	●
PM-4EL-D4.0		4	6	15	75	4	A	●
PM-4EL-D5.0		5	6	20	75	4	A	●
PM-4EL-D6.0		6	6	20	75	4	B	●
PM-4EL-D8.0		8	8	25	100	4	B	●
PM-4EL-D10.0		10	10	30	100	4	B	●
PM-4EL-D12.0		12	12	35	100	4	B	●
PM-4EL-D14.0		14	14	40	100	4	B	●
PM-4EL-D16.0		16	16	50	150	4	B	●
PM-4EL-D20.0		20	20	55	150	4	B	●

● Ex stock ○ On demand

* With internal cooling

Application field					
P	M	K	N	S	H
✓	✓	✓			✓

✓ Very suitable

✓ Suitable

A

Turning

B

Milling

C

Drilling

D

Technical Information

E

Index

System code > B278

Cutting data > B492

Nonstandard order > B541

A

End mill High-performance machining

PM-6E

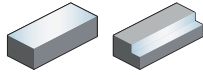

- Factory standard
- Non-centre cutting
- Helix angle 45°

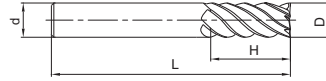

Turning

B

Article	*	Dimensions [mm]				Teeth	Grade
		D	d (h6)	H	L		KMG405
PM-6E-D6.0		6	6	18	60	6	●
PM-6E-D8.0		8	8	20	60	6	●
PM-6E-D10.0		10	10	30	75	6	●
PM-6E-D12.0		12	12	32	75	6	●
PM-6E-D16.0		16	16	40	100	6	●
PM-6E-D20.0		20	20	45	100	6	●

- Ex stock ○ On demand
- * With internal cooling

Milling

C

Application field						
P	M	K	N	S	H	
✓	✓	✓			✓	✓ Very suitable ✓ Suitable

Drilling

D

Technical Information

E

Index

System code > B278

Cutting data > B492

Nonstandard order > B541

End mill long cutting edge

High-performance machining

PM-6EL

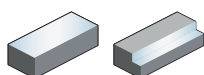

- Factory standard
- Non-centre cutting
- Helix angle 45°

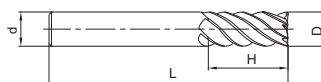

Article	*	Dimensions [mm]				Teeth	Grade
		D	d (h6)	H	L		KMG405
PM-6EL-D6.0		6	6	24	75	6	●
PM-6EL-D8.0		8	8	32	75	6	●
PM-6EL-D10.0		10	10	40	100	6	●
PM-6EL-D12.0		12	12	45	100	6	●
PM-6EL-D16.0		16	16	64	150	6	●
PM-6EL-D20.0		20	20	75	150	6	●

● Ex stock ○ On demand

* With internal cooling

Application field					
P	M	K	N	S	H
✓	✓	✓			✓

✓ Very suitable

✓ Suitable

A

Turning

B

Milling

C

Drilling

D

Technical Information

E

Index

System code > B278

Cutting data > B492

Nonstandard order > B541

A

Ball nose cutter High-performance machining

PM-2B

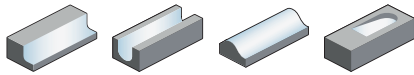

- Factory standard
- Centre cutting
- Helix angle 30°

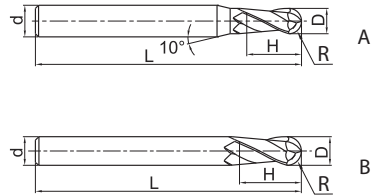

Turning

B

Milling

C

Drilling

D

Technical Information

Article	*	Dimensions [mm]					Teeth	Geometry	Grade
		R	D	d (h6)	H	L			KMG405
PM-2B-R0.5S		0.5	1	4	2	50	2	A	●
PM-2B-R0.75S		0.75	1.5	4	3	50	2	A	●
PM-2B-R1.0S		1	2	4	4	50	2	A	●
PM-2B-R1.25S		1.25	2.5	4	5	50	2	A	●
PM-2B-R1.5S		1.5	3	4	6	50	2	A	●
PM-2B-R2.0S		2	4	4	8	50	2	B	●
PM-2B-R0.5		0.5	1	6	2	50	2	A	●
PM-2B-R0.75		0.75	1.5	6	3	50	2	A	●
PM-2B-R1.0		1	2	6	4	50	2	A	●
PM-2B-R1.25		1.25	2.5	6	5	50	2	A	●
PM-2B-R1.5		1.5	3	6	6	50	2	A	●
PM-2B-R1.75		1.75	3.5	6	8	50	2	A	●
PM-2B-R2.0		2	4	6	8	50	2	A	●
PM-2B-R2.5		2.5	5	6	10	50	2	A	●
PM-2B-R2.75		2.75	5.5	6	12	50	2	A	●
PM-2B-R3.0		3	6	6	12	50	2	B	●
PM-2B-R3.5		3.5	7	8	14	60	2	A	●
PM-2B-R4.0		4	8	8	16	60	2	B	●
PM-2B-R4.5		4.5	9	10	18	75	2	A	●
PM-2B-R5.0		5	10	10	20	75	2	B	●
PM-2B-R6.0		6	12	12	24	75	2	B	●
PM-2B-R7.0		7	14	14	28	75	2	B	●
PM-2B-R8.0		8	16	16	32	100	2	B	●
PM-2B-R10.0		10	20	20	40	100	2	B	●

● Ex stock ○ On demand

* With internal cooling

E

Index

Application field

P	M	K	N	S	H
✓	✓	✓			✓

✓ Very suitable

✓ Suitable

System code > B278

Cutting data > B492

Nonstandard order > B541

Ball nose cutter long shank **High-performance machining**

PM-2BL

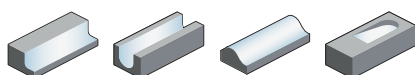

- Factory standard
- Centre cutting
- Helix angle 30°

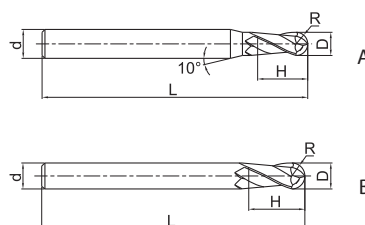

Article	*	Dimensions [mm]					Teeth	Geometry	Grade
		R	D	d (h6)	H	L			KMG405
PM-2BL-R1.0		1	2	6	4	75	2	A	●
PM-2BL-R1.25		1.25	2.5	6	5	75	2	A	●
PM-2BL-R1.5		1.5	3	6	6	75	2	A	●
PM-2BL-R1.75		1.75	3.5	6	8	75	2	A	●
PM-2BL-R2.0		2	4	6	8	75	2	A	●
PM-2BL-R2.5		2.5	5	6	10	75	2	A	●
PM-2BL-R2.75		2.75	5.5	6	12	75	2	A	●
PM-2BL-R3.0		3	6	6	12	75	2	B	●
PM-2BL-R3.5		3.5	7	8	14	75	2	A	●
PM-2BL-R4.0		4	8	8	16	100	2	B	●
PM-2BL-R4.5		4.5	9	10	18	100	2	A	●
PM-2BL-R5.0		5	10	10	20	100	2	B	●
PM-2BL-R6.0		6	12	12	24	100	2	B	●
PM-2BL-R7.0		7	14	14	28	100	2	B	●
PM-2BL-R8.0		8	16	16	32	150	2	B	●
PM-2BL-R10.0		10	20	20	40	150	2	B	●

● Ex stock ○ On demand

* With internal cooling

Application field					
P	M	K	N	S	H
✓	✓	✓			✓

✓ Very suitable

✓ Suitable

System code > B278

Cutting data > B492

Nonstandard order > B541



A

Ball nose cutter short cutting edge High-performance machining

PM-2BFP

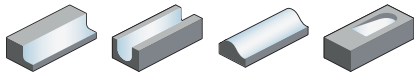

- Factory standard
- Centre cutting
- Helix angle 30°

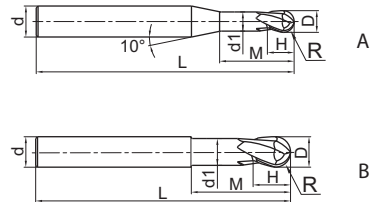

Turning

B

Milling

C

Drilling

Article	*	Dimensions [mm]								Teeth	Geometry	Grade
		R	D	d (h6)	d ₁	H	M	L	KMG405			
PM-2BFP-R0.5		0.5	1	6	0.95	1	2.5	75	2	A	●	
PM-2BFP-R0.75		0.75	1.5	6	1.45	1.5	3	75	2	A	●	
PM-2BFP-R1.0		1	2	6	1.95	2	4	75	2	A	●	
PM-2BFP-R1.5		1.5	3	6	2.85	3	6	75	2	A	●	
PM-2BFP-R2.0		2	4	6	3.85	4	8	75	2	A	●	
PM-2BFP-R2.5		2.5	5	6	4.85	5	10	75	2	A	●	
PM-2BFP-R3.0		3	6	6	5.8	6	12	75	2	B	●	
PM-2BFP-R4.0		4	8	8	7.8	8	16	100	2	B	●	
PM-2BFP-R5.0		5	10	10	9.6	10	20	100	2	B	●	
PM-2BFP-R6.0		6	12	12	11.5	12	24	100	2	B	●	
PM-2BFP-R8.0		8	16	16	15.5	16	32	150	2	B	●	
PM-2BFP-R10.0		10	20	20	19.5	20	40	150	2	B	●	

● Ex stock ○ On demand

* With internal cooling

D

Technical Information

Application field

P	M	K	N	S	H
✓	✓	✓			✓

✓ Very suitable

✓ Suitable

E

Index

System code > B278

Cutting data > B492

Nonstandard order > B541

Ball nose cutter conical neck

High-performance machining

PM-2BC

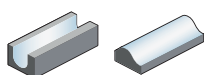

- Straight shank
- Centre cutting
- Helix angle 30°

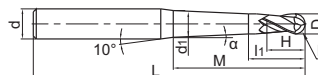

Article	*	Dimensions [mm]										Teeth	Grade KMG405
		R	D	d (h6)	d ₁	M	H	L	α	l ₁			
PM-2BC05-R0.25-M03		0.25	0.5	4	0.49	3	0.5	50	0.5	1.5	2	○	
PM-2BC05-R0.25-M05		0.25	0.5	4	0.53	5	0.5	50	0.5	1.5	2	○	
PM-2BC10-R0.25-M03		0.25	0.5	4	0.52	3	0.5	50	1	1.5	2	○	
PM-2BC10-R0.25-M05		0.25	0.5	4	0.59	5	0.5	50	1	1.5	2	○	
PM-2BC15-R0.25-M03		0.25	0.5	4	0.54	3	0.5	50	1.5	1.5	2	○	
PM-2BC15-R0.25-M05		0.25	0.5	4	0.65	5	0.5	50	1.5	1.5	2	○	
PM-2BC05-R0.30-M05		0.3	0.6	4	0.62	5	0.6	50	0.5	1.6	2	○	
PM-2BC05-R0.30-M08		0.3	0.6	4	0.68	8	0.6	50	0.5	1.6	2	○	
PM-2BC10-R0.30-M05		0.3	0.6	4	0.68	5	0.6	50	1	1.6	2	○	
PM-2BC10-R0.30-M08		0.3	0.6	4	0.79	8	0.6	50	1	1.6	2	○	
PM-2BC10-R0.30-M10		0.3	0.6	4	0.86	10	0.6	50	1	1.6	2	○	
PM-2BC10-R0.30-M12		0.3	0.6	4	0.93	12	0.6	50	1	1.6	2	○	
PM-2BC10-R0.30-M15		0.3	0.6	4	1.03	15	0.6	50	1	1.6	2	○	
PM-2BC15-R0.30-M05		0.3	0.6	4	0.74	5	0.6	50	1.5	1.6	2	○	
PM-2BC15-R0.30-M08		0.3	0.6	4	0.9	8	0.6	50	1.5	1.6	2	○	
PM-2BC05-R0.40-M08		0.4	0.8	4	0.87	8	0.8	50	0.5	1.8	2	○	
PM-2BC10-R0.40-M08		0.4	0.8	4	0.98	8	0.8	50	1	1.8	2	○	
PM-2BC15-R0.40-M08		0.4	0.8	4	1.09	8	0.8	50	1.5	1.8	2	○	
PM-2BC05-R0.40-M12		0.4	0.8	4	0.94	12	0.8	60	0.5	1.8	2	○	
PM-2BC10-R0.40-M12		0.4	0.8	4	1.12	12	0.8	60	1	1.8	2	○	
PM-2BC15-R0.40-M12		0.4	0.8	4	1.3	12	0.8	60	1.5	1.8	2	○	
PM-2BC05-R0.50-M10		0.5	1	6	1.08	10	1	60	0.5	2.5	2	○	
PM-2BC05-R0.50-M15		0.5	1	6	1.16	15	1	60	0.5	2.5	2	○	
PM-2BC10-R0.50-M10		0.5	1	6	1.21	10	1	60	1	2.5	2	○	
PM-2BC10-R0.50-M15		0.5	1	6	1.38	15	1	60	1	2.5	2	○	
PM-2BC15-R0.50-M10		0.5	1	6	1.34	10	1	60	1.5	2.5	2	○	
PM-2BC15-R0.50-M15		0.5	1	6	1.6	15	1	60	1.5	2.5	2	○	
PM-2BC20-R0.50-M15		0.5	1	6	1.82	15	1	60	2	2.5	2	○	
PM-2BC05-R0.50-M20		0.5	1	6	1.25	20	1	70	0.5	2.5	2	○	
PM-2BC05-R0.50-M25		0.5	1	6	1.34	25	1	70	0.5	2.5	2	○	
PM-2BC05-R0.50-M30		0.5	1	6	1.42	30	1	70	0.5	2.5	2	○	
PM-2BC10-R0.50-M20		0.5	1	6	1.56	20	1	70	1	2.5	2	○	
PM-2BC10-R0.50-M25		0.5	1	6	1.73	25	1	70	1	2.5	2	○	
PM-2BC10-R0.50-M30		0.5	1	6	1.91	30	1	70	1	2.5	2	○	
PM-2BC15-R0.50-M20		0.5	1	6	1.86	20	1	70	1.5	2.5	2	○	
PM-2BC20-R0.50-M20		0.5	1	6	2.17	20	1	70	2	2.5	2	○	
PM-2BC30-R0.50-M20		0.5	1	6	2.78	20	1	70	3	2.5	2	○	

● Ex stock ○ On demand

* With internal cooling

Application field					
P	M	K	N	S	H
✓	✓	✓			✓

✓ Very suitable

✓ Suitable

System code > B278 Cutting data > B492 Nonstandard order > B541



A

Turning

B

Milling

C

Drilling

D

Technical Information

E

Index

Ball nose cutter conical neck

High-performance machining

PM-2BC

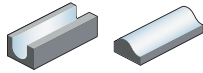

- Straight shank
- Centre cutting
- Helix angle 30°

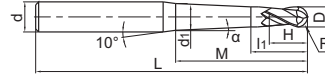

Article	*	Dimensions [mm]										Teeth	Grade
		R	D	d (h6)	d _i	M	H	L	α	I ₁	KMG405		
PM-2BC50-R0.50-M20		0.5	1	6	4.01	20	1	70	5	2.5	2	○	
PM-2BC10-R0.50-M35		0.5	1	6	2.08	35	1	80	1	2.5	2	○	
PM-2BC05-R0.60-M12		0.6	1.2	6	1.31	12	1.2	60	0.5	2.7	2	○	
PM-2BC10-R0.60-M12		0.6	1.2	6	1.47	12	1.2	60	1	2.7	2	○	
PM-2BC15-R0.60-M12		0.6	1.2	6	1.63	12	1.2	60	1.5	2.7	2	○	
PM-2BC05-R0.60-M24		0.6	1.2	6	1.52	24	1.2	70	0.5	2.7	2	○	
PM-2BC10-R0.60-M24		0.6	1.2	6	1.89	24	1.2	70	1	2.7	2	○	
PM-2BC15-R0.60-M24		0.6	1.2	6	2.26	24	1.2	70	1.5	2.7	2	○	
PM-2BC05-R0.75-M10		0.75	1.5	6	1.57	10	1.5	60	0.5	3	2	○	
PM-2BC05-R0.75-M15		0.75	1.5	6	1.65	15	1.5	60	0.5	3	2	○	
PM-2BC10-R0.75-M10		0.75	1.5	6	1.69	10	1.5	60	1	3	2	○	
PM-2BC10-R0.75-M15		0.75	1.5	6	1.86	15	1.5	60	1	3	2	○	
PM-2BC15-R0.75-M10		0.75	1.5	6	1.81	10	1.5	60	1.5	3	2	○	
PM-2BC15-R0.75-M15		0.75	1.5	6	2.07	15	1.5	60	1.5	3	2	○	
PM-2BC05-R0.75-M30		0.75	1.5	6	1.92	30	1.5	70	0.5	3	2	○	
PM-2BC10-R0.75-M20		0.75	1.5	6	2.04	20	1.5	70	1	3	2	○	
PM-2BC10-R0.75-M30		0.75	1.5	6	2.39	30	1.5	70	1	3	2	○	
PM-2BC15-R0.75-M30		0.75	1.5	6	2.86	30	1.5	70	1.5	3	2	○	
PM-2BC05-R1.0-M20		1	2	6	2.18	20	2	60	0.5	4	2	○	
PM-2BC10-R1.0-M20		1	2	6	2.46	20	2	60	1	4	2	○	
PM-2BC10-R1.0-M25		1	2	6	2.64	25	2	60	1	4	2	○	
PM-2BC15-R1.0-M20		1	2	6	2.74	20	2	60	1.5	4	2	○	
PM-2BC05-R1.0-M30		1	2	6	2.36	30	2	70	0.5	4	2	○	
PM-2BC10-R1.0-M30		1	2	6	2.81	30	2	70	1	4	2	○	
PM-2BC15-R1.0-M30		1	2	6	3.27	30	2	70	1.5	4	2	○	
PM-2BC20-R1.0-M30		1	2	6	3.72	30	2	70	2	4	2	○	
PM-2BC30-R1.0-M30		1	2	6	4.63	30	2	70	3	4	2	○	
PM-2BC05-R1.0-M40		1	2	6	2.53	40	2	80	0.5	4	2	○	
PM-2BC10-R1.0-M35		1	2	6	2.99	35	2	80	1	4	2	○	
PM-2BC10-R1.0-M40		1	2	6	3.16	40	2	80	1	4	2	○	
PM-2BC15-R1.0-M40		1	2	6	3.79	40	2	80	1.5	4	2	○	
PM-2BC20-R1.0-M40		1	2	6	4.42	40	2	80	2	4	2	○	
PM-2BC30-R1.0-M40		1	2	6	5.68	40	2	80	3	4	2	○	
PM-2BC10-R1.0-M50		1	2	6	3.51	50	2	90	1	4	2	○	
PM-2BC05-R1.5-M30		1.5	3	6	3.32	30	3	70	0.5	6	2	○	
PM-2BC10-R1.5-M30		1.5	3	6	3.74	30	3	70	1	6	2	○	
PM-2BC15-R1.5-M30		1.5	3	6	4.16	30	3	70	1.5	6	2	○	

● Ex stock ○ On demand

* With internal cooling

Application field

P	M	K	N	S	H
✓	✓	✓			✓

✓ Very suitable

✓ Suitable

System code > B278

Cutting data > B492

Nonstandard order > B541

Ball nose cutter conical neck

High-performance machining

PM-2BC

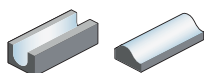

- Straight shank
- Centre cutting
- Helix angle 30°

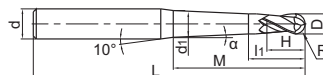

Article	*	Dimensions [mm]										Grade	
		R	D	d (h6)	d ₁	M	H	L	α	l ₁	Teeth	KMG405	
PM-2BC05-R1.5-M40		1.5	3	6	3.5	40	3	80	0.5	6	2	○	
PM-2BC10-R1.5-M40		1.5	3	6	4.09	40	3	80	1	6	2	○	
PM-2BC15-R1.5-M40		1.5	3	6	4.69	40	3	80	1.5	6	2	○	
PM-2BC05-R1.5-M50		1.5	3	6	3.67	50	3	90	0.5	6	2	○	
PM-2BC10-R1.5-M50		1.5	3	6	4.44	50	3	90	1	6	2	○	
PM-2BC15-R1.5-M50		1.5	3	6	5.21	50	3	90	1.5	6	2	○	
PM-2BC05-R2.0-M60		2	4	6	4.83	60	4	110	0.5	7	2	○	
PM-2BC10-R2.0-M60		2	4	6	5.76	60	4	110	1	7	2	○	

● Ex stock ○ On demand

* With internal cooling

Application field					
P	M	K	N	S	H
✓	✓	✓			✓

- ✓ Very suitable
- ✓ Suitable

A

Turning

B

Milling

C

Drilling

D

Technical Information

E

Index

System code > B278

Cutting data > B492

Nonstandard order > B541



A

Ball nose cutter High-performance machining

PM-4B

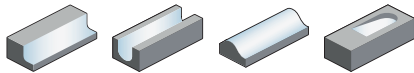

- Factory standard
- Centre cutting
- Helix angle 30°

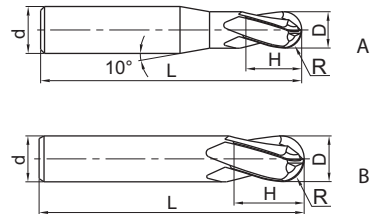
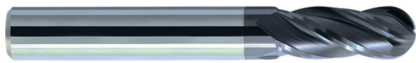

Turning

B

Milling

Article	*	Dimensions [mm]					Teeth	Geometry	Grade
		R	D	d (h6)	H	L			KMG405
PM-4B-R1.5		1.5	3	6	6	50	4	A	●
PM-4B-R2.0		2	4	6	8	50	4	A	●
PM-4B-R2.5		2.5	5	6	10	50	4	A	●
PM-4B-R3.0		3	6	6	12	50	4	B	●
PM-4B-R4.0		4	8	8	16	60	4	B	●
PM-4B-R5.0		5	10	10	20	75	4	B	●
PM-4B-R6.0		6	12	12	24	75	4	B	●
PM-4B-R7.0		7	14	14	28	75	4	B	●
PM-4B-R8.0		8	16	16	32	100	4	B	●
PM-4B-R9.0		9	18	18	36	100	4	B	●
PM-4B-R10.0		10	20	20	40	100	4	B	●

● Ex stock ○ On demand

* With internal cooling

C

Drilling

D

Technical Information

E

Index

Application field

P	M	K	N	S	H
✓	✓	✓			✓

✓ Very suitable

✓ Suitable

System code > B278

Cutting data > B492

Nonstandard order > B541

Ball nose cutter long shank High-performance machining

PM-4BL

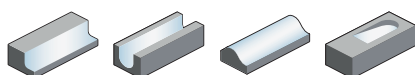

- Factory standard
- Centre cutting
- Helix angle 30°

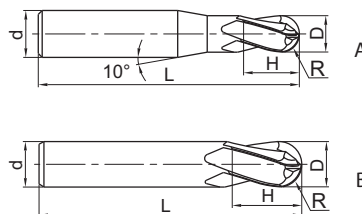

Article	*	Dimensions [mm]					Teeth	Geometry	Grade
		R	D	d (h6)	H	L			KMG405
PM-4BL-R1.5		1.5	3	6	6	75	4	A	●
PM-4BL-R2.0		2	4	6	8	75	4	A	●
PM-4BL-R2.5		2.5	5	6	10	75	4	A	●
PM-4BL-R3.0		3	6	6	12	75	4	B	●
PM-4BL-R4.0		4	8	8	16	100	4	B	●
PM-4BL-R5.0		5	10	10	20	100	4	B	●
PM-4BL-R6.0		6	12	12	24	100	4	B	●
PM-4BL-R7.0		7	14	14	28	100	4	B	●
PM-4BL-R8.0		8	16	16	32	150	4	B	●
PM-4BL-R9.0		9	18	18	36	150	4	B	●
PM-4BL-R10.0		10	20	20	40	150	4	B	●

● Ex stock ○ On demand

* With internal cooling

Application field					
P	M	K	N	S	H
✓	✓	✓			✓

✓ Very suitable

✓ Suitable

A

Turning

B

Milling

C

Drilling

D

Technical Information

E

Index

System code > B278

Cutting data > B492

Nonstandard order > B541

A

Torus mill High-performance machining

PM-2R

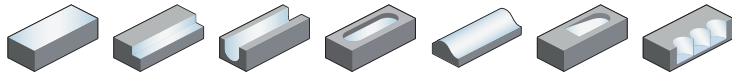

- Factory standard
- Centre cutting
- Helix angle 30°

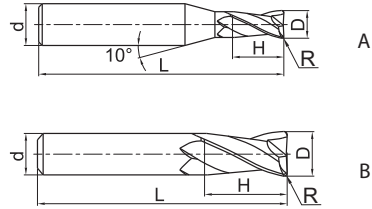

Turning

B

Milling

C

Drilling

D

Technical Information

E

Index

Article	*	Dimensions [mm]					Teeth	Geometry	Grade
		R	D	d (h6)	H	L			
PM-2R-D1.0R0.2		0.2	1	4	3	50	2	A	●
PM-2R-D1.5R0.2		0.2	1.5	4	4	50	2	A	●
PM-2R-D2.0R0.2		0.2	2	4	6	50	2	A	●
PM-2R-D2.0R0.5		0.5	2	4	6	50	2	A	●
PM-2R-D2.5R0.2		0.2	2.5	4	8	50	2	A	●
PM-2R-D2.5R0.5		0.5	2.5	4	8	50	2	A	●
PM-2R-D3.0R0.2		0.2	3	4	8	50	2	A	●
PM-2R-D3.0R0.3		0.3	3	4	8	50	2	A	○
PM-2R-D3.0R0.5		0.5	3	4	8	50	2	A	●
PM-2R-D4.0R0.2		0.2	4	4	11	50	2	B	●
PM-2R-D4.0R0.3		0.3	4	4	11	50	2	B	●
PM-2R-D4.0R0.5		0.5	4	4	11	50	2	B	●
PM-2R-D4.0R1.0		1	4	4	11	50	2	B	●
PM-2R-D5.0R0.3		0.3	5	6	13	50	2	A	○
PM-2R-D5.0R0.5		0.5	5	6	13	50	2	A	●
PM-2R-D5.0R1.0		1	5	6	13	50	2	A	●
PM-2R-D6.0R0.3		0.3	6	6	16	50	2	B	●
PM-2R-D6.0R0.5		0.5	6	6	16	50	2	B	●
PM-2R-D6.0R1.0		1	6	6	16	50	2	B	●
PM-2R-D8.0R0.3		0.3	8	8	20	60	2	B	○
PM-2R-D8.0R0.5		0.5	8	8	20	60	2	B	●
PM-2R-D8.0R1.0		1	8	8	20	60	2	B	●
PM-2R-D10.0R0.5		0.5	10	10	25	75	2	B	●
PM-2R-D10.0R1.0		1	10	10	25	75	2	B	●
PM-2R-D10.0R1.5		1.5	10	10	25	75	2	B	●
PM-2R-D10.0R2.0		2	10	10	25	75	2	B	●
PM-2R-D12.0R0.5		0.5	12	12	30	75	2	B	●
PM-2R-D12.0R1.0		1	12	12	30	75	2	B	●
PM-2R-D12.0R1.5		1.5	12	12	30	75	2	B	●
PM-2R-D12.0R2.0		2	12	12	30	75	2	B	●

- Ex stock ○ On demand
- * With internal cooling

Application field

P	M	K	N	S	H	
✓	✓	✓			✓	✓ Very suitable ✓ Suitable

System code > B278 Cutting data > B492 Nonstandard order > B541



End mill **High-performance machining**

PM-4H

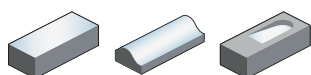

- Factory standard
- Centre cutting
- Helix angle 0°

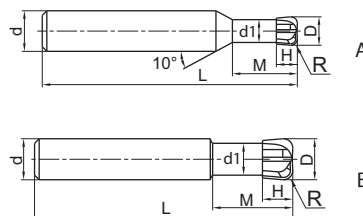

Article	*	Dimensions [mm]							Teeth	Geometry	Grade
		R	D	d (h6)	d ₁	H	M	L			KMG405
PM-4H-D3.0R0.8		0.8	3	6	2.7	1.2	8	50	4	A	●
PM-4H-D4.0R1.0		1	4	6	3.6	1.6	10	50	4	A	●
PM-4H-D5.0R1.2		1.2	5	6	4.5	2	12.5	50	4	A	●
PM-4H-D6.0R1.0		1	6	6	5.4	2.5	12	50	4	B	●
PM-4H-D6.0R1.5		1.5	6	6	5.4	2.5	12	50	4	B	●
PM-4H-D6.0R2.0		2	6	6	5.4	2.5	12	50	4	B	●
PM-4H-D8.0R1.0		1	8	8	7	3.5	16	60	4	B	●
PM-4H-D8.0R2.0		2	8	8	7	3.5	16	60	4	B	●
PM-4H-D10.0R1.0		1	10	10	9	4	20	75	4	B	●
PM-4H-D10.0R2.0		2	10	10	9	4	20	75	4	B	●
PM-4H-D10.0R3.0		3	10	10	9	4	20	75	4	B	●
PM-4H-D12.0R2.0		2	12	12	11	5	24	75	4	B	●
PM-4H-D12.0R3.0		3	12	12	11	5	24	75	4	B	●

● Ex stock ○ On demand

* With internal cooling

Application field

P	M	K	N	S	H
✓	✓	✓			✓

✓ Very suitable

✓ Suitable

System code > B278

Cutting data > B492

Nonstandard order > B541



A

End mill long shank High-performance machining

PM-4HL

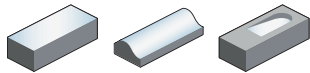

- Factory standard
- Centre cutting
- Helix angle 0°

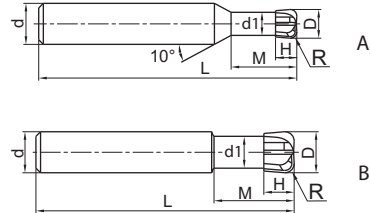

Turning

B

Milling

C

Drilling

Article	*	Dimensions [mm]							Teeth	Geometry	Grade
		R	D	d (h6)	d ₁	H	M	L			
PM-4HL-D4.0R1.0		1	4	6	3.6	1.6	10	75	4	A	●
PM-4HL-D5.0R1.2		1.2	5	6	4.5	2	12.5	75	4	A	●
PM-4HL-D6.0R1.0		1	6	6	5.4	2.5	12	75	4	B	●
PM-4HL-D6.0R1.5		1.5	6	6	5.4	2.5	12	75	4	B	●
PM-4HL-D6.0R2.0		2	6	6	5.4	2.5	12	75	4	B	●
PM-4HL-D8.0R1.0		1	8	8	7	3.5	16	100	4	B	●
PM-4HL-D8.0R2.0		2	8	8	7	3.5	16	100	4	B	●
PM-4HL-D10.0R1.0		1	10	10	9	4	20	100	4	B	●
PM-4HL-D10.0R2.0		2	10	10	9	4	20	100	4	B	●
PM-4HL-D10.0R3.0		3	10	10	9	4	20	100	4	B	●
PM-4HL-D12.0R2.0		2	12	12	11	5	24	100	4	B	●
PM-4HL-D12.0R3.0		3	12	12	11	5	24	100	4	B	●

● Ex stock ○ On demand

* With internal cooling

D

Technical Information

Application field

P	M	K	N	S	H
✓	✓	✓			✓

✓ Very suitable

✓ Suitable

F

Index

System code > B278

Cutting data > B492

Nonstandard order > B541

Torus mill

High-performance machining

PM-4R

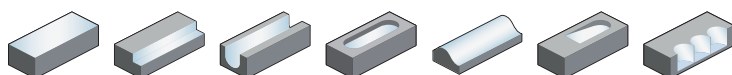

- Factory standard
- Centre cutting
- Helix angle 30°

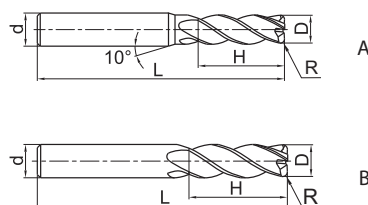

Article	*	Dimensions [mm]					Teeth	Geometry	Grade
		R	D	d (h6)	H	L			KMG405
PM-4R-D3.0R0.2		0.2	3	6	8	50	4	A	●
PM-4R-D4.0R0.3		0.3	4	6	10	50	4	A	●
PM-4R-D4.0R0.5		0.5	4	6	10	50	4	A	●
PM-4R-D5.0R0.5		0.5	5	6	13	50	4	A	●
PM-4R-D5.0R1.0		1	5	6	13	50	4	A	●
PM-4R-D6.0R0.5		0.5	6	6	16	50	4	B	●
PM-4R-D6.0R1.0		1	6	6	16	50	4	B	●
PM-4R-D8.0R0.5		0.5	8	8	20	60	4	B	●
PM-4R-D8.0R1.0		1	8	8	20	60	4	B	●
PM-4R-D10.0R0.5		0.5	10	10	25	75	4	B	●
PM-4R-D10.0R1.0		1	10	10	25	75	4	B	●
PM-4R-D10.0R2.0		2	10	10	25	75	4	B	●
PM-4R-D10.0R3.0		3	10	10	25	75	4	B	●
PM-4R-D12.0R0.5		0.5	12	12	30	75	4	B	●
PM-4R-D12.0R1.0		1	12	12	30	75	4	B	●
PM-4R-D12.0R2.0		2	12	12	30	75	4	B	●
PM-4R-D12.0R3.0		3	12	12	30	75	4	B	●

● Ex stock ○ On demand

* With internal cooling

Application field					
P	M	K	N	S	H
✓	✓	✓			✓

✓ Very suitable

✓ Suitable

System code > B278

Cutting data > B492

Nonstandard order > B541



A

Torus mill long shank High-performance machining

PM-4RL

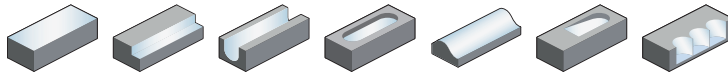

- Factory standard
- Centre cutting
- Helix angle 30°

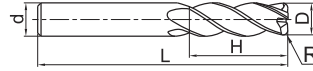

Turning

B

Article	*	Dimensions [mm]					Teeth	Grade
		R	D	d (h6)	H	L		KMG405
PM-4RL-D6.0R0.5	*	0.5	6	6	16	75	4	●
PM-4RL-D6.0R1.0		1	6	6	16	75	4	●
PM-4RL-D8.0R0.5		0.5	8	8	20	100	4	●
PM-4RL-D8.0R1.0		1	8	8	20	100	4	○
PM-4RL-D10.0R0.5		0.5	10	10	25	100	4	○
PM-4RL-D10.0R1.0		1	10	10	25	100	4	●
PM-4RL-D10.0R2.0		2	10	10	25	100	4	●
PM-4RL-D12.0R0.5		0.5	12	12	30	100	4	●
PM-4RL-D12.0R1.0		1	12	12	30	100	4	●
PM-4RL-D12.0R2.0		2	12	12	30	100	4	●
PM-4RL-D16.0R1.0		1	16	16	45	150	4	●
PM-4RL-D16.0R2.0		2	16	16	45	150	4	●

- Ex stock ○ On demand
- * With internal cooling

Milling

C

Application field						
P	M	K	N	S	H	
✓	✓	✓			✓	✓ Very suitable ✓ Suitable

Drilling

D

Technical Information

E

Index

System code > B278

Cutting data > B492

Nonstandard order > B541

End mill **High-performance machining**

PM-2ES

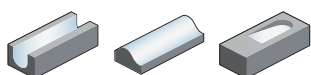

- Factory standard
- Centre cutting
- Helix angle 35°

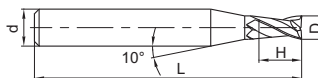

Article	*	Dimensions [mm]				Teeth	Grade
		D	d (h6)	H	L		KMG405
PM-2ES-D0.3		0.3	4	0.6	50	2	●
PM-2ES-D0.4		0.4	4	0.8	50	2	●
PM-2ES-D0.5		0.5	4	1	50	2	●
PM-2ES-D0.6		0.6	4	1.2	50	2	●
PM-2ES-D0.7		0.7	4	1.4	50	2	●
PM-2ES-D0.8		0.8	4	1.6	50	2	●
PM-2ES-D0.9		0.9	4	1.8	50	2	○
PM-2ES-D1.0		1	4	2	50	2	●
PM-2ES-D1.1		1.1	4	2	50	2	○
PM-2ES-D1.2		1.2	4	2.5	50	2	●
PM-2ES-D1.3		1.3	4	2.5	50	2	●
PM-2ES-D1.4		1.4	4	3	50	2	●
PM-2ES-D1.5		1.5	4	3	50	2	●
PM-2ES-D1.6		1.6	4	3.5	50	2	●
PM-2ES-D1.7		1.7	4	3.5	50	2	●
PM-2ES-D1.8		1.8	4	4	50	2	●
PM-2ES-D1.9		1.9	4	4	50	2	○
PM-2ES-D2.0		2	4	4	50	2	●
PM-2ES-D2.1		2.1	4	4	50	2	●
PM-2ES-D2.2		2.2	4	4.5	50	2	●
PM-2ES-D2.3		2.3	4	4.5	50	2	●
PM-2ES-D2.4		2.4	4	5	50	2	●
PM-2ES-D2.5		2.5	4	5	50	2	●
PM-2ES-D2.6		2.6	4	5	50	2	○
PM-2ES-D2.7		2.7	4	5.5	50	2	○
PM-2ES-D2.8		2.8	4	5.5	50	2	○
PM-2ES-D2.9		2.9	4	6	50	2	○
PM-2ES-D3.0		3	4	6	50	2	●

● Ex stock ○ On demand

* With internal cooling

Application field					
P	M	K	N	S	H
✓	✓	✓			✓

✓ Very suitable

✓ Suitable

System code > B278

Cutting data > B492

Nonstandard order > B541



A

End mill High-performance machining

PM-2EP

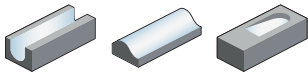

- Factory standard
- Centre cutting
- Helix angle 35°

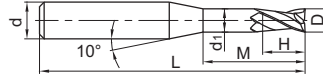

Turning

B

Article	*	Dimensions [mm]						Teeth	Grade
		D	d (h6)	d ₁	H	M	L		KMG405
PM-2EP-D0.5-M06		0.5	4	0.45	0.7	6	50	2	●
PM-2EP-D0.5-M04		0.5	4	0.45	0.6	4	50	2	●
PM-2EP-D0.5-M08		0.5	4	0.45	0.7	8	50	2	○
PM-2EP-D0.8-M04		0.8	4	0.75	1.2	4	50	2	●
PM-2EP-D0.8-M08		0.8	4	0.75	1.2	8	50	2	○
PM-2EP-D0.8-M10		0.8	4	0.75	1.2	10	50	2	○
PM-2EP-D0.8-M06		0.8	4	0.75	1.2	6	50	2	○
PM-2EP-D1.0-M20		1	4	0.95	1.5	20	50	2	●
PM-2EP-D1.0-M14		1	4	0.95	1.5	14	50	2	●
PM-2EP-D1.0-M16		1	4	0.95	1.5	16	50	2	●
PM-2EP-D1.0-M04		1	4	0.95	1.5	4	50	2	●
PM-2EP-D1.0-M06		1	4	0.95	1.5	6	50	2	●
PM-2EP-D1.0-M10		1	4	0.95	1.5	10	50	2	●
PM-2EP-D1.0-M12		1	4	0.95	1.5	12	50	2	●
PM-2EP-D1.0-M08		1	4	0.95	1.5	8	50	2	●
PM-2EP-D1.2-M10		1.2	4	1.15	1.8	10	50	2	○
PM-2EP-D1.2-M06		1.2	4	1.15	1.8	6	50	2	●
PM-2EP-D1.2-M08		1.2	4	1.15	1.8	8	50	2	○
PM-2EP-D1.2-M16		1.2	4	1.15	1.8	16	50	2	○
PM-2EP-D1.2-M12		1.2	4	1.15	1.8	12	50	2	○
PM-2EP-D1.5-M18		1.5	4	1.45	2.3	18	50	2	●
PM-2EP-D1.5-M16		1.5	4	1.45	2.3	16	50	2	●
PM-2EP-D1.5-M10		1.5	4	1.45	2.3	10	50	2	●
PM-2EP-D1.5-M12		1.5	4	1.45	2.3	12	50	2	●
PM-2EP-D1.5-M14		1.5	4	1.45	2.3	14	50	2	●
PM-2EP-D1.5-M20		1.5	4	1.45	2.3	20	50	2	●
PM-2EP-D1.5-M08		1.5	4	1.45	2.3	8	50	2	●
PM-2EP-D1.5-M06		1.5	4	1.45	2.3	6	50	2	●
PM-2EP-D2.0-M20		2	4	1.95	3	20	50	2	●
PM-2EP-D2.0-M12		2	4	1.95	3	12	50	2	●
PM-2EP-D2.0-M10		2	4	1.95	3	10	50	2	●
PM-2EP-D2.0-M18		2	4	1.95	3	18	50	2	●
PM-2EP-D2.0-M16		2	4	1.95	3	16	50	2	●
PM-2EP-D2.0-M08		2	4	1.95	3	8	50	2	●
PM-2EP-D2.0-M14		2	4	1.95	3	14	50	2	●
PM-2EP-D2.0-M06		2	4	1.95	3	6	50	2	●
PM-2EP-D2.5-M08		2.5	4	2.4	3.7	8	50	2	●

● Ex stock ○ On demand

* With internal cooling

Milling

C

Drilling

D

Technical Information

E

Index

Application field

P	M	K	N	S	H
✓	✓	✓			✓

✓ Very suitable

✓ Suitable

System code > B278

Cutting data > B492

Nonstandard order > B541

End mill High-performance machining

PM-2EP

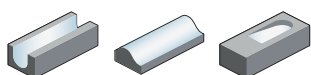

- Factory standard
- Centre cutting
- Helix angle 35°

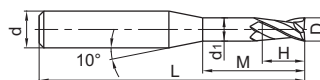

Article	*	Dimensions [mm]						Teeth	Grade
		D	d (h6)	d ₁	H	M	L		KMG405
PM-2EP-D2.5-M10		2.5	4	2.4	3.7	10	50	2	○
PM-2EP-D2.5-M16		2.5	4	2.4	3.7	16	60	2	○
PM-2EP-D2.5-M20		2.5	4	2.4	3.7	20	60	2	○
PM-2EP-D2.5-M14		2.5	4	2.4	3.7	14	50	2	○
PM-2EP-D2.5-M12		2.5	4	2.4	3.7	12	50	2	○
PM-2EP-D2.5-M18		2.5	4	2.4	3.7	18	60	2	○
PM-2EP-D3.0-M18		3	6	2.85	4.5	18	60	2	○
PM-2EP-D3.0-M10		3	6	2.85	4.5	10	50	2	●
PM-2EP-D3.0-M20		3	6	2.85	4.5	20	60	2	●
PM-2EP-D3.0-M16		3	6	2.85	4.5	16	60	2	●
PM-2EP-D3.0-M06		3	6	2.85	4.5	6	50	2	○
PM-2EP-D3.0-M14		3	6	2.85	4.5	14	60	2	○
PM-2EP-D3.0-M12		3	6	2.85	4.5	12	50	2	●
PM-2EP-D3.0-M08		3	6	2.85	4.5	8	50	2	○
PM-2EP-D4.0-M20		4	6	3.85	6	20	60	2	●
PM-2EP-D4.0-M14		4	6	3.85	6	14	60	2	○
PM-2EP-D4.0-M16		4	6	3.85	6	16	60	2	○
PM-2EP-D4.0-M25		4	6	3.85	6	25	60	2	●
PM-2EP-D4.0-M12		4	6	3.85	6	12	50	2	●
PM-2EP-D5.0-M25		5	6	4.85	7.5	25	70	2	●
PM-2EP-D5.0-M12		5	6	4.85	7.5	12	60	2	●
PM-2EP-D5.0-M14		5	6	4.85	7.5	14	60	2	●
PM-2EP-D5.0-M20		5	6	4.85	7.5	20	70	2	●
PM-2EP-D5.0-M16		5	6	4.85	7.5	16	60	2	●

● Ex stock ○ On demand

* With internal cooling

Application field					
P	M	K	N	S	H
✓	✓	✓			✓

✓ Very suitable

✓ Suitable

System code > B278

Cutting data > B492

Nonstandard order > B541



A

Ball nose cutter High-performance machining

PM-2BS

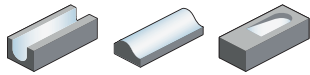

- Factory standard
- Centre cutting
- Helix angle 35°

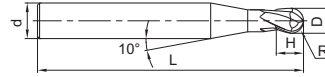

Turning

B

Article	*	Dimensions [mm]					Teeth	Grade
		R	D	d (h6)	H	L		KMG405
PM-2BS-R0.15		0.15	0.3	4	0.5	50	2	●
PM-2BS-R0.20		0.2	0.4	4	0.6	50	2	●
PM-2BS-R0.25		0.25	0.5	4	0.8	50	2	●
PM-2BS-R0.30		0.3	0.6	4	0.9	50	2	●
PM-2BS-R0.35		0.35	0.7	4	1	50	2	○
PM-2BS-R0.40		0.4	0.8	4	1.2	50	2	●
PM-2BS-R0.45		0.45	0.9	4	1.3	50	2	○
PM-2BS-R0.50		0.5	1	4	1.5	50	2	●
PM-2BS-R0.60		0.6	1.2	4	1.8	50	2	●
PM-2BS-R0.70		0.7	1.4	4	2	50	2	○
PM-2BS-R0.75		0.75	1.5	4	2.3	50	2	●
PM-2BS-R0.80		0.8	1.6	4	2.5	50	2	○
PM-2BS-R0.90		0.9	1.8	4	2.7	50	2	○
PM-2BS-R1.00		1	2	4	3	50	2	●
PM-2BS-R1.25		1.25	2.5	4	3.7	50	2	○
PM-2BS-R1.50		1.5	3	4	4.5	50	2	●

Milling

C

- Ex stock ○ On demand
- * With internal cooling

Drilling

D

Application field

P	M	K	N	S	H
✓	✓	✓			✓

- ✓ Very suitable
- ✓ Suitable

Technical Information

E

Index

System code > B278

Cutting data > B492

Nonstandard order > B541

Ball nose cutter **High-performance machining**

PM-2BP

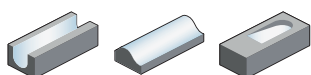

- Factory standard
- Centre cutting
- Helix angle 35°

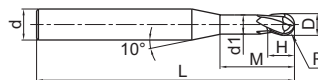

Article	*	Dimensions [mm]								Teeth	Grade KMG405
		R	D	d (h6)	d ₁	H	M	L			
PM-2BP-R0.25-M04		0.25	0.5	4	0.45	0.7	4	50	2	●	
PM-2BP-R0.25-M06		0.25	0.5	4	0.45	0.7	6	50	2	●	
PM-2BP-R0.3-M06		0.3	0.6	4	0.55	0.9	6	50	2	●	
PM-2BP-R0.3-M08		0.3	0.6	4	0.55	0.9	8	50	2	●	
PM-2BP-R0.3-M04		0.3	0.6	4	0.55	0.9	4	50	2	●	
PM-2BP-R0.4-M04		0.4	0.8	4	0.75	1.2	4	50	2	●	
PM-2BP-R0.4-M10		0.4	0.8	4	0.75	1.2	10	50	2	●	
PM-2BP-R0.4-M06		0.4	0.8	4	0.75	1.2	6	50	2	●	
PM-2BP-R0.4-M08		0.4	0.8	4	0.75	1.2	8	50	2	●	
PM-2BP-R0.5-M06		0.5	1	4	0.95	1.5	6	50	2	●	
PM-2BP-R0.5-M15		0.5	1	4	0.95	1.5	15	50	2	○	
PM-2BP-R0.5-M04		0.5	1	4	0.95	1.5	4	50	2	●	
PM-2BP-R0.5-M08		0.5	1	4	0.95	1.5	8	50	2	●	
PM-2BP-R0.5-M10		0.5	1	4	0.95	1.5	10	50	2	●	
PM-2BP-R0.5-M12		0.5	1	4	0.95	1.5	12	50	2	●	
PM-2BP-R0.6-M16		0.6	1.2	4	1.15	1.8	16	50	2	○	
PM-2BP-R0.6-M06		0.6	1.2	4	1.15	1.8	6	50	2	●	
PM-2BP-R0.6-M12		0.6	1.2	4	1.15	1.8	12	50	2	○	
PM-2BP-R0.6-M08		0.6	1.2	4	1.15	1.8	8	50	2	○	
PM-2BP-R0.75-M08		0.75	1.5	4	1.45	2.3	8	50	2	●	
PM-2BP-R0.75-M06		0.75	1.5	4	1.45	2.3	6	50	2	○	
PM-2BP-R0.75-M12		0.75	1.5	4	1.45	2.3	12	50	2	●	
PM-2BP-R0.75-M16		0.75	1.5	4	1.45	2.3	16	50	2	●	
PM-2BP-R1.0-M16		1	2	4	1.95	3	16	50	2	●	
PM-2BP-R1.0-M06		1	2	4	1.95	3	6	50	2	●	
PM-2BP-R1.0-M20		1	2	4	1.95	3	20	50	2	●	
PM-2BP-R1.0-M10		1	2	4	1.95	3	10	50	2	●	
PM-2BP-R1.0-M12		1	2	4	1.95	3	12	50	2	●	
PM-2BP-R1.0-M08		1	2	4	1.95	3	8	50	2	●	
PM-2BP-R1.25-M08		1.25	2.5	4	2.4	3.7	8	50	2	○	
PM-2BP-R1.25-M10		1.25	2.5	4	2.4	3.7	10	50	2	○	
PM-2BP-R1.25-M16		1.25	2.5	4	2.4	3.7	16	60	2	○	
PM-2BP-R1.25-M12		1.25	2.5	4	2.4	3.7	12	50	2	●	
PM-2BP-R1.25-M20		1.25	2.5	4	2.4	3.7	20	60	2	○	
PM-2BP-R1.5-M10		1.5	3	6	2.85	4.5	10	50	2	●	
PM-2BP-R1.5-M20		1.5	3	6	2.85	4.5	20	60	2	●	
PM-2BP-R1.5-M08		1.5	3	6	2.85	4.5	8	50	2	●	

● Ex stock ○ On demand

* With internal cooling

Application field					
P	M	K	N	S	H
✓	✓	✓			✓

✓ Very suitable

✓ Suitable

System code > B278 Cutting data > B492 Nonstandard order > B541



A

Turning

B

Milling

C

Drilling

D

Technical Information

E

Index

A

Ball nose cutter High-performance machining

PM-2BP

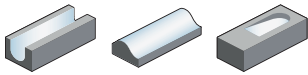

- Factory standard
- Centre cutting
- Helix angle 35°

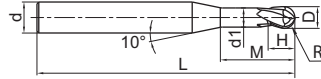

Turning

B

Article	*	Dimensions [mm]							Teeth	Grade
		R	D	d (h6)	d ₁	H	M	L		KMG405
PM-2BP-R1.5-M12		1.5	3	6	2.85	4.5	12	50	2	●
PM-2BP-R1.5-M16		1.5	3	6	2.85	4.5	16	60	2	●
PM-2BP-R2.0-M10		2	4	6	3.85	6	10	60	2	●
PM-2BP-R2.0-M16		2	4	6	3.85	6	16	60	2	●
PM-2BP-R2.0-M20		2	4	6	3.85	6	20	60	2	●
PM-2BP-R2.0-M25		2	4	6	3.85	6		60	2	○
PM-2BP-R2.5-M16		2.5	5	6	4.85	7.5	16	60	2	●
PM-2BP-R2.5-M25		2.5	5	6	4.85	7.5	25	70	2	●

● Ex stock ○ On demand

* With internal cooling

Milling

C

Application field

P	M	K	N	S	H
✓	✓	✓			✓

- ✓ Very suitable
- ✓ Suitable

Drilling

D

Technical Information

E

Index

System code > B278

Cutting data > B492

Nonstandard order > B541

Torus mill **High-performance machining**

PM-2RP

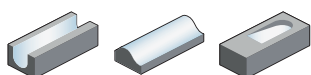

- Factory standard
- Centre cutting
- Helix angle 35°

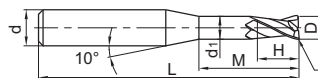

Article	*	Dimensions [mm]								Teeth	Grade
		R	D	d (h6)	d ₁	H	M	L	KMG405		
PM-2RP-D0.5-R0.1-M04		0.1	0.5	4	0.45	0.6	4	50	2	●	
PM-2RP-D0.5-R0.1-M08		0.1	0.5	4	0.45	0.7	8	50	2	○	
PM-2RP-D0.5-R0.1-M06		0.1	0.5	4	0.45	0.7	6	50	2	●	
PM-2RP-D0.5-R0.05-M06		0.05	0.5	4	0.45	0.7	6	50	2	●	
PM-2RP-D0.5-R0.05-M08		0.05	0.5	4	0.45	0.7	8	50	2	○	
PM-2RP-D0.5-R0.05-M04		0.05	0.5	4	0.45	0.6	4	50	2	●	
PM-2RP-D0.8-R0.1-M04		0.1	0.8	4	0.75	1.2	4	50	2	●	
PM-2RP-D0.8-R0.1-M08		0.1	0.8	4	0.75	1.2	8	50	2	●	
PM-2RP-D0.8-R0.2-M04		0.2	0.8	4	0.75	1.2	4	50	2	●	
PM-2RP-D0.8-R0.1-M10		0.1	0.8	4	0.75	1.2	10	50	2	○	
PM-2RP-D0.8-R0.2-M08		0.2	0.8	4	0.75	1.2	8	50	2	●	
PM-2RP-D0.8-R0.2-M10		0.2	0.8	4	0.75	1.2	10	50	2	○	
PM-2RP-D0.8-R0.1-M06		0.1	0.8	4	0.75	1.2	6	50	2	●	
PM-2RP-D0.8-R0.2-M06		0.2	0.8	4	0.75	1.2	6	50	2	●	
PM-2RP-D1.0-R0.3-M12		0.3	1	4	0.95	1.5	12	50	2	●	
PM-2RP-D1.0-R0.3-M08		0.3	1	4	0.95	1.5	8	50	2	●	
PM-2RP-D1.0-R0.2-M16		0.2	1	4	0.95	1.5	16	60	2	●	
PM-2RP-D1.0-R0.2-M14		0.2	1	4	0.95	1.5	14	50	2	○	
PM-2RP-D1.0-R0.1-M20		0.1	1	4	0.95	1.5	20	60	2	●	
PM-2RP-D1.0-R0.3-M10		0.3	1	4	0.95	1.5	10	50	2	●	
PM-2RP-D1.0-R0.1-M10		0.1	1	4	0.95	1.5	10	50	2	●	
PM-2RP-D1.0-R0.1-M12		0.1	1	4	0.95	1.5	12	50	2	●	
PM-2RP-D1.0-R0.3-M04		0.3	1	4	0.95	1.5	4	50	2	●	
PM-2RP-D1.0-R0.2-M04		0.2	1	4	0.95	1.5	4	50	2	●	
PM-2RP-D1.0-R0.2-M12		0.2	1	4	0.95	1.5	12	50	2	●	
PM-2RP-D1.0-R0.1-M14		0.1	1	4	0.95	1.5	14	50	2	○	
PM-2RP-D1.0-R0.2-M08		0.2	1	4	0.95	1.5	8	50	2	●	
PM-2RP-D1.0-R0.1-M06		0.1	1	4	0.95	1.5	6	50	2	●	
PM-2RP-D1.0-R0.2-M20		0.2	1	4	0.95	1.5	20	60	2	●	
PM-2RP-D1.0-R0.1-M04		0.1	1	4	0.95	1.5	4	50	2	●	
PM-2RP-D1.0-R0.3-M06		0.3	1	4	0.95	1.5	6	50	2	●	
PM-2RP-D1.0-R0.1-M16		0.1	1	4	0.95	1.5	16	60	2	●	
PM-2RP-D1.0-R0.2-M06		0.2	1	4	0.95	1.5	6	50	2	●	
PM-2RP-D1.0-R0.2-M10		0.2	1	4	0.95	1.5	10	50	2	●	
PM-2RP-D1.0-R0.1-M08		0.1	1	4	0.95	1.5	8	50	2	●	
PM-2RP-D1.2-R0.2-M16		0.2	1.2	4	1.5	1.8	16	60	2	○	
PM-2RP-D1.2-R0.1-M08		0.1	1.2	4	1.15	1.8	8	50	2	●	

● Ex stock ○ On demand

* With internal cooling

Application field					
P	M	K	N	S	H
✓	✓	✓			✓

✓ Very suitable

✓ Suitable

System code > B278

Cutting data > B492

Nonstandard order > B541



A

Torus mill High-performance machining

PM-2RP

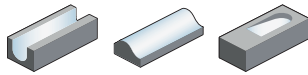

- Factory standard
- Centre cutting
- Helix angle 35°

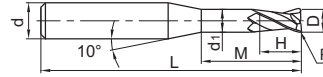

Turning

B

Article	*	Dimensions [mm]							Teeth	Grade
		R	D	d (h6)	d ₁	H	M	L		KMG405
PM-2RP-D1.2-R0.1-M16		0.1	1.2	4	1.5	1.8	16	60	2	○
PM-2RP-D1.2-R0.2-M12		0.2	1.2	4	1.15	1.8	12	50	2	●
PM-2RP-D1.2-R0.1-M06		0.1	1.2	4	1.15	1.8	6	50	2	●
PM-2RP-D1.2-R0.2-M10		0.2	1.2	4	1.15	1.8	10	50	2	●
PM-2RP-D1.2-R0.1-M12		0.1	1.2	4	1.15	1.8	12	50	2	●
PM-2RP-D1.2-R0.2-M06		0.2	1.2	4	1.15	1.8	6	50	2	●
PM-2RP-D1.2-R0.2-M08		0.2	1.2	4	1.15	1.8	8	50	2	●
PM-2RP-D1.2-R0.1-M10		0.1	1.2	4	1.15	1.8	10	50	2	●
PM-2RP-D1.5-R0.3-M12		0.3	1.5	4	1.45	2.3	12	50	2	●
PM-2RP-D1.5-R0.3-M10		0.3	1.5	4	1.45	2.3	10	50	2	●
PM-2RP-D1.5-R0.2-M12		0.2	1.5	4	1.45	2.3	12	50	2	●
PM-2RP-D1.5-R0.3-M08		0.3	1.5	4	1.45	2.3	8	50	2	●
PM-2RP-D1.5-R0.2-M06		0.2	1.5	4	1.45	2.3	6	50	2	●
PM-2RP-D1.5-R0.2-M10		0.2	1.5	4	1.45	2.3	10	50	2	●
PM-2RP-D1.5-R0.2-M14		0.2	1.5	4	1.45	2.3	14	50	2	○
PM-2RP-D1.5-R0.2-M20		0.2	1.5	4	1.45	2.3	20	50	2	○
PM-2RP-D1.5-R0.3-M18		0.3	1.5	4	1.45	2.3	18	50	2	○
PM-2RP-D1.5-R0.3-M20		0.3	1.5	4	1.45	2.3	20	50	2	○
PM-2RP-D1.5-R0.3-M06		0.3	1.5	4	1.45	2.3	6	50	2	●
PM-2RP-D1.5-R0.2-M08		0.2	1.5	4	1.45	2.3	8	50	2	●
PM-2RP-D1.5-R0.2-M18		0.2	1.5	4	1.45	2.3	18	50	2	○
PM-2RP-D1.5-R0.2-M16		0.2	1.5	4	1.45	2.3	16	50	2	●
PM-2RP-D1.5-R0.3-M16		0.3	1.5	4	1.45	2.3	16	50	2	●
PM-2RP-D1.5-R0.3-M14		0.3	1.5	4	1.45	2.3	14	50	2	○
PM-2RP-D2.0-R0.5-M06		0.5	2	4	1.95	3	6	50	2	●
PM-2RP-D2.0-R0.2-M10		0.2	2	4	1.95	3	10	50	2	●
PM-2RP-D2.0-R0.5-M20		0.5	2	4	1.97	3	20	50	2	●
PM-2RP-D2.0-R0.5-M08		0.5	2	4	1.95	3	8	50	2	●
PM-2RP-D2.0-R0.5-M16		0.5	2	4	1.95	3	16	50	2	●
PM-2RP-D2.0-R0.2-M08		0.2	2	4	1.95	3	8	50	2	●
PM-2RP-D2.0-R0.2-M16		0.2	2	4	1.95	3	16	50	2	●
PM-2RP-D2.0-R0.5-M12		0.5	2	4	1.95	3	12	50	2	●
PM-2RP-D2.0-R0.5-M14		0.5	2	4	1.95	3	14	50	2	○
PM-2RP-D2.0-R0.5-M10		0.5	2	4	1.95	3	10	50	2	●
PM-2RP-D2.0-R0.2-M18		0.2	2	4	1.96	3	18	50	2	○
PM-2RP-D2.0-R0.2-M12		0.2	2	4	1.95	3	12	50	2	●
PM-2RP-D2.0-R0.5-M18		0.5	2	4	1.96	3	18	50	2	○

● Ex stock ○ On demand

* With internal cooling

C

Drilling

D

Technical Information

E

Index

Application field

P	M	K	N	S	H
✓	✓	✓			✓

✓ Very suitable

✓ Suitable

System code > B278

Cutting data > B492

Nonstandard order > B541

Torus mill **High-performance machining**

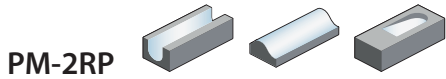

- Factory standard
- Centre cutting
- Helix angle 35°

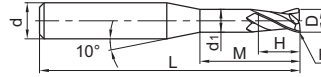

Article	*	Dimensions [mm]								Teeth	Grade
		R	D	d (h6)	d ₁	H	M	L	KMG405		
PM-2RP-D2.0-R0.2-M20		0.2	2	4	1.97	3	20	50	2	●	
PM-2RP-D2.0-R0.2-M06		0.2	2	4	1.95	3	6	50	2	●	
PM-2RP-D2.0-R0.2-M14		0.2	2	4	1.95	3	14	50	2	○	
PM-2RP-D2.5-R0.2-M16		0.2	2.5	4	2.4	3.7	16	60	2	○	
PM-2RP-D2.5-R0.2-M18		0.2	2.5	4	2.4	3.7	18	60	2	○	
PM-2RP-D2.5-R0.2-M08		0.2	2.5	4	2.4	3.7	8	50	2	●	
PM-2RP-D2.5-R0.2-M20		0.2	2.5	4	2.4	3.7	20	60	2	●	
PM-2RP-D2.5-R0.5-M14		0.5	2.5	4	2.4	3.7	14	50	2	○	
PM-2RP-D2.5-R0.5-M20		0.5	2.5	4	2.4	3.7	20	60	2	●	
PM-2RP-D2.5-R0.5-M10		0.5	2.5	4	2.4	3.7	10	50	2	●	
PM-2RP-D2.5-R0.5-M18		0.5	2.5	4	2.4	3.7	18	60	2	○	
PM-2RP-D2.5-R0.2-M10		0.2	2.5	4	2.4	3.7	10	50	2	●	
PM-2RP-D2.5-R0.5-M08		0.5	2.5	4	2.4	3.7	8	50	2	●	
PM-2RP-D2.5-R0.5-M12		0.5	2.5	4	2.4	3.7	12	50	2	○	
PM-2RP-D2.5-R0.5-M16		0.5	2.5	4	2.4	3.7	16	60	2	○	
PM-2RP-D2.5-R0.2-M14		0.2	2.5	4	2.4	3.7	14	50	2	○	
PM-2RP-D2.5-R0.2-M12		0.2	2.5	4	2.4	3.7	12	50	2	○	
PM-2RP-D3.0-R0.5-M18		0.5	3	6	2.85	4.5	18	60	2	○	
PM-2RP-D3.0-R0.2-M18		0.2	3	6	2.85	4.5	18	60	2	○	
PM-2RP-D3.0-R0.5-M08		0.5	3	6	2.85	4.5	8	50	2	●	
PM-2RP-D3.0-R0.2-M08		0.2	3	6	2.85	4.5	8	50	2	●	
PM-2RP-D3.0-R0.2-M06		0.2	3	6	2.85	4.5	6	50	2	○	
PM-2RP-D3.0-R0.2-M20		0.2	3	6	2.85	4.5	20	60	2	●	
PM-2RP-D3.0-R0.5-M10		0.5	3	6	2.85	4.5	10	50	2	●	
PM-2RP-D3.0-R0.2-M10		0.2	3	6	2.85	4.5	10	50	2	●	
PM-2RP-D3.0-R0.5-M14		0.5	3	6	2.85	4.5	14	60	2	○	
PM-2RP-D3.0-R0.5-M06		0.5	3	6	2.85	4.5	6	50	2	○	
PM-2RP-D3.0-R0.2-M16		0.2	3	6	2.85	4.5	16	60	2	●	
PM-2RP-D3.0-R0.2-M12		0.2	3	6	2.85	4.5	12	50	2	●	
PM-2RP-D3.0-R0.5-M20		0.5	3	6	2.85	4.5	20	60	2	●	
PM-2RP-D3.0-R0.5-M12		0.5	3	6	2.85	4.5	12	50	2	●	
PM-2RP-D3.0-R0.2-M14		0.2	3	6	2.85	4.5	14	60	2	○	
PM-2RP-D3.0-R0.5-M16		0.5	3	6	2.85	4.5	16	60	2	●	
PM-2RP-D4.0-R0.2-M12		0.2	4	6	3.85	6	12	50	2	●	
PM-2RP-D4.0-R0.5-M20		0.5	4	6	3.85	6	20	60	2	●	
PM-2RP-D4.0-R0.5-M12		0.5	4	6	3.85	6	12	50	2	●	
PM-2RP-D4.0-R0.5-M14		0.5	4	6	3.85	6	14	60	2	○	

● Ex stock ○ On demand

* With internal cooling

Application field					
P	M	K	N	S	H
✓	✓	✓			✓

✓ Very suitable

✓ Suitable

System code > B278 Cutting data > B492 Nonstandard order > B541



A
Turning
B
Milling
C
Drilling
D
Technical Information
E
Index

A

Torus mill High-performance machining

PM-2RP

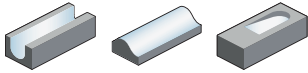

- Factory standard
- Centre cutting
- Helix angle 35°

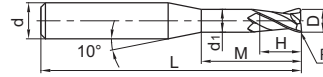

Turning

B

Article	*	Dimensions [mm]							Teeth	Grade KMG405
		R	D	d (h6)	d ₁	H	M	L		
PM-2RP-D4.0-R0.2-M20	*	0.2	4	6	3.85	6	20	60	2	●
PM-2RP-D4.0-R0.2-M16	*	0.2	4	6	3.85	6	16	60	2	●
PM-2RP-D4.0-R0.5-M25	*	0.5	4	6	3.85	6	25	60	2	●
PM-2RP-D4.0-R0.5-M16	*	0.5	4	6	3.85	6	16	60	2	●
PM-2RP-D4.0-R0.2-M25	*	0.2	4	6	3.85	6	25	60	2	●
PM-2RP-D4.0-R0.2-M14	*	0.2	4	6	3.85	6	14	60	2	○
PM-2RP-D5.0-R0.5-M14	*	0.5	5	6	4.85	7.5	14	60	2	○
PM-2RP-D5.0-R0.5-M12	*	0.5	5	6	4.85	7.5	12	60	2	●
PM-2RP-D5.0-R1.0-M12	*	1	5	6	4.85	7.5	12	60	2	●
PM-2RP-D5.0-R0.5-M20	*	0.5	5	6	4.85	7.5	20	70	2	●
PM-2RP-D5.0-R1.0-M14	*	1	5	6	4.85	7.5	14	60	2	○
PM-2RP-D5.0-R0.5-M25	*	0.5	5	6	4.85	7.5	25	70	2	●
PM-2RP-D5.0-R1.0-M20	*	1	5	6	4.85	7.5	20	70	2	●
PM-2RP-D5.0-R1.0-M25	*	1	5	6	4.85	7.5	25	70	2	●
PM-2RP-D5.0-R0.5-M16	*	0.5	5	6	4.85	7.5	16	60	2	●
PM-2RP-D5.0-R1.0-M16	*	1	5	6	4.85	7.5	16	60	2	●

● Ex stock ○ On demand

* With internal cooling

Milling

C

Drilling

D

Technical Information

Application field

P	M	K	N	S	H
✓	✓	✓			✓

✓ Very suitable

✓ Suitable

E

Index

System code > B278

Cutting data > B492

Nonstandard order > B541

End mill **High-performance machining**

EPM-2E

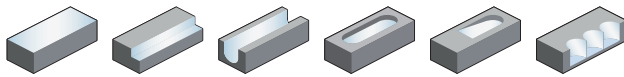

- Factory standard
- Centre cutting
- Helix angle 30°

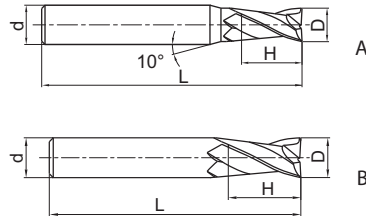

Article	*	Dimensions [mm]				Teeth	Geometry	Grade
		D	d (h6)	H	L			KMG406
EPM-2E-D3.0		3	6	8	50	2	A	●
EPM-2E-D4.0		4	6	11	50	2	A	●
EPM-2E-D5.0		5	6	13	50	2	A	●
EPM-2E-D6.0		6	6	16	50	2	B	●
EPM-2E-D8.0		8	8	20	60	2	B	●
EPM-2E-D10.0		10	10	25	75	2	B	●
EPM-2E-D12.0		12	12	30	75	2	B	●
EPM-2E-D14.0		14	14	32	75	2	B	●
EPM-2E-D16.0		16	16	45	100	2	B	●
EPM-2E-D18.0		18	18	45	100	2	B	●
EPM-2E-D20.0		20	20	45	100	2	B	●

● Ex stock ○ On demand

* With internal cooling

Application field					
P	M	K	N	S	H
✓	✓	✓			✓

✓ Very suitable

✓ Suitable

System code > B278

Cutting data > B492

Nonstandard order > B541



A

End mill High-performance machining

EPM-2E-W

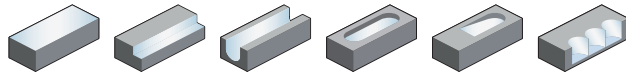

- Type of shank DIN 6535HB
- Centre cutting
- Helix angle 30°

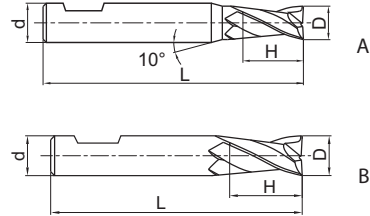

Turning

B

Milling

Article	*	Dimensions [mm]				Teeth	Geometry	Grade
		D	d (h6)	H	L			KMG406
EPM-2E-D3.0-W		3	6	4	50	2	A	●
EPM-2E-D4.0-W		4	6	5	54	2	A	●
EPM-2E-D5.0-W		5	6	6	54	2	A	●
EPM-2E-D6.0-W		6	6	7	54	2	B	●
EPM-2E-D8.0-W		8	8	9	58	2	B	●
EPM-2E-D10.0-W		10	10	11	66	2	B	●
EPM-2E-D12.0-W		12	12	12	73	2	B	●
EPM-2E-D14.0-W		14	14	14	75	2	B	●
EPM-2E-D16.0-W		16	16	16	82	2	B	●
EPM-2E-D18.0-W		18	18	18	84	2	B	●
EPM-2E-D20.0-W		20	20	20	92	2	B	●

- Ex stock ○ On demand
- * With internal cooling

C

Drilling

D

Technical Information

E

Index

Application field

P	M	K	N	S	H
✓	✓	✓			✓

- ✓ Very suitable
- ✓ Suitable

System code > B278

Cutting data > B492

Nonstandard order > B541

End mill long cutting edge **High-performance machining**

EPM-2EL

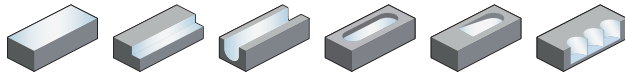

- Factory standard
- Centre cutting
- Helix angle 30°

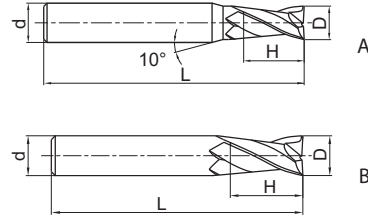

Article	*	Dimensions [mm]				Teeth	Geometry	Grade
		D	d (h6)	H	L			KMG406
EPM-2EL-D3.0		3	6	12	75	2	A	●
EPM-2EL-D4.0		4	6	15	75	2	A	●
EPM-2EL-D5.0		5	6	20	75	2	A	●
EPM-2EL-D6.0		6	6	20	75	2	B	●
EPM-2EL-D8.0		8	8	25	100	2	B	●
EPM-2EL-D10.0		10	10	30	100	2	B	●
EPM-2EL-D12.0		12	12	35	100	2	B	●
EPM-2EL-D14.0		14	14	40	100	2	B	●
EPM-2EL-D16.0		16	16	50	150	2	B	●
EPM-2EL-D20.0		20	20	55	150	2	B	●

- Ex stock ○ On demand
- * With internal cooling

Application field					
P	M	K	N	S	H
✓	✓	✓			✓

- ✓ Very suitable
- ✓ Suitable

A

Turning

B

Milling

C

Drilling

D

Technical Information

E

Index



A

End mill long cutting edge High-performance machining

EPM-2EL-W

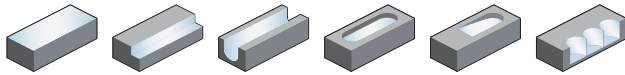

- Type of shank DIN 6535HB
- Centre cutting
- Helix angle 30°

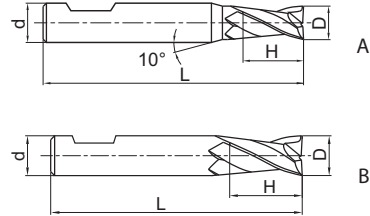

Turning

B

Milling

Article	*	Dimensions [mm]				Teeth	Geometry	Grade
		D	d (h6)	H	L			KMG406
EPM-2EL-D3.0-W		3	6	6	57	2	A	●
EPM-2EL-D4.0-W		4	6	8	57	2	A	●
EPM-2EL-D5.0-W		5	6	10	57	2	A	●
EPM-2EL-D6.0-W		6	6	10	57	2	B	●
EPM-2EL-D8.0-W		8	8	16	63	2	B	●
EPM-2EL-D10.0-W		10	10	19	72	2	B	●
EPM-2EL-D12.0-W		12	12	22	83	2	B	●
EPM-2EL-D14.0-W		14	14	22	83	2	B	●
EPM-2EL-D16.0-W		16	16	26	92	2	B	●
EPM-2EL-D18.0-W		18	18	26	92	2	B	●
EPM-2EL-D20.0-W		20	20	32	104	2	B	●

● Ex stock ○ On demand

* With internal cooling

C

Drilling

D

Technical Information

E

Index

Application field

P	M	K	N	S	H
✓	✓	✓			✓

✓ Very suitable

✓ Suitable

System code > B278

Cutting data > B492

Nonstandard order > B541

End mill High-performance machining

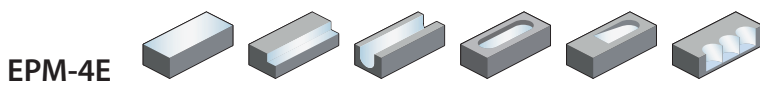

- Factory standard
- Centre cutting
- Helix angle 45°

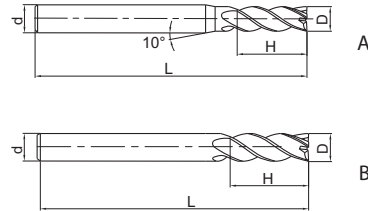
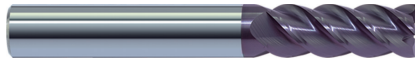

Article	*	Dimensions [mm]				Teeth	Geometry	Grade
		D	d (h6)	H	L			KMG406
EPM-4E-D3.0		3	6	8	50	4	A	●
EPM-4E-D4.0		4	6	11	50	4	A	●
EPM-4E-D5.0		5	6	13	50	4	A	●
EPM-4E-D6.0		6	6	16	50	4	B	●
EPM-4E-D8.0		8	8	20	60	4	B	●
EPM-4E-D10.0		10	10	25	75	4	B	●
EPM-4E-D12.0		12	12	30	75	4	B	●
EPM-4E-D14.0		14	14	32	75	4	B	●
EPM-4E-D16.0		16	16	45	100	4	B	●
EPM-4E-D18.0		18	18	45	100	4	B	●
EPM-4E-D20.0		20	20	45	100	4	B	●

● Ex stock ○ On demand

* With internal cooling

Application field					
P	M	K	N	S	H
✓	✓	✓			✓

✓ Very suitable

✓ Suitable

System code > B278

Cutting data > B492

Nonstandard order > B541



A

End mill High-performance machining

EPM-4E-W

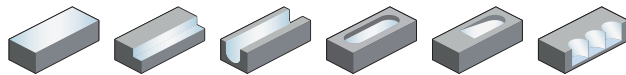

- Type of shank DIN 6535HB
- Centre cutting
- Helix angle 45°

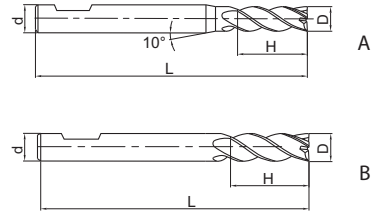

Turning

B

Milling

Article	*	Dimensions [mm]				Teeth	Geometry	Grade
		D	d (h6)	H	L			KMG406
EPM-4E-D3.0-W		3	6	4	50	4	A	●
EPM-4E-D4.0-W		4	6	5	54	4	A	●
EPM-4E-D5.0-W		5	6	6	54	4	A	●
EPM-4E-D6.0-W		6	6	7	54	4	B	●
EPM-4E-D8.0-W		8	8	9	58	4	B	●
EPM-4E-D10.0-W		10	10	11	66	4	B	●
EPM-4E-D12.0-W		12	12	12	73	4	B	●
EPM-4E-D14.0-W		14	14	14	75	4	B	●
EPM-4E-D16.0-W		16	16	16	82	4	B	●
EPM-4E-D18.0-W		18	18	18	84	4	B	●
EPM-4E-D20.0-W		20	20	20	92	4	B	●

● Ex stock ○ On demand

* With internal cooling

C

Drilling

D

Technical Information

E

Index

Application field

P	M	K	N	S	H
✓	✓	✓			✓

✓ Very suitable

✓ Suitable

System code > B278

Cutting data > B492

Nonstandard order > B541

End mill long cutting edge **High-performance machining**

EPM-4EL

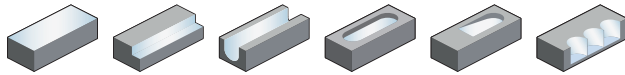

- Factory standard
- Centre cutting
- Helix angle 45°

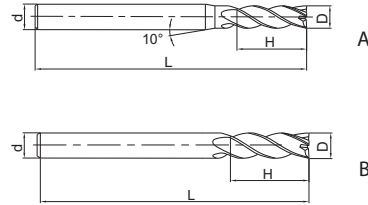

Article	*	Dimensions [mm]				Teeth	Geometry	Grade
		D	d (h6)	H	L			KMG406
EPM-4EL-D3.0		3	6	12	75	4	A	●
EPM-4EL-D4.0		4	6	15	75	4	A	●
EPM-4EL-D5.0		5	6	20	75	4	A	●
EPM-4EL-D6.0		6	6	20	75	4	B	●
EPM-4EL-D8.0		8	8	25	100	4	B	●
EPM-4EL-D10.0		10	10	30	100	4	B	●
EPM-4EL-D12.0		12	12	35	100	4	B	●
EPM-4EL-D14.0		14	14	40	100	4	B	●
EPM-4EL-D16.0		16	16	50	150	4	B	●
EPM-4EL-D20.0		20	20	55	150	4	B	●

- Ex stock ○ On demand
- * With internal cooling

Application field					
P	M	K	N	S	H
✓	✓	✓			✓

- ✓ Very suitable
- ✓ Suitable

A

Turning

B

Milling

C

Drilling

D

Technical Information

E

Index



A

End mill long cutting edge High-performance machining

EPM-4EL-W

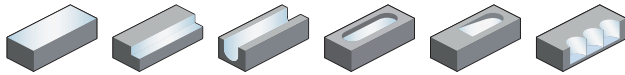

- Type of shank DIN 6535HB
- Centre cutting
- Helix angle 45°

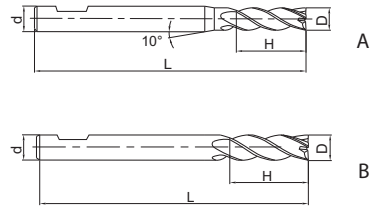

Turning

B

Milling

Article	*	Dimensions [mm]				Teeth	Geometry	Grade
		D	d (h6)	H	L			KMG406
EPM-4EL-D3.0-W		3	6	8	57	4	A	●
EPM-4EL-D4.0-W		4	6	11	57	4	A	●
EPM-4EL-D5.0-W		5	6	13	57	4	A	●
EPM-4EL-D6.0-W		6	6	13	57	4	B	●
EPM-4EL-D8.0-W		8	8	19	63	4	B	●
EPM-4EL-D10.0-W		10	10	22	72	4	B	●
EPM-4EL-D12.0-W		12	12	26	83	4	B	●
EPM-4EL-D14.0-W		14	14	26	83	4	B	●
EPM-4EL-D16.0-W		16	16	32	92	4	B	●
EPM-4EL-D18.0-W		18	18	32	92	4	B	●
EPM-4EL-D20.0-W		20	20	38	104	4	B	●

● Ex stock ○ On demand

* With internal cooling

C

Drilling

D

Technical Information

E

Index

Application field

P	M	K	N	S	H
✓	✓	✓			✓

✓ Very suitable

✓ Suitable

System code > B278

Cutting data > B492

Nonstandard order > B541

Ball nose cutter **High-performance machining**

EPM-2B

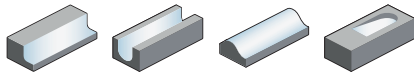

- Factory standard
- Centre cutting
- Helix angle 30°

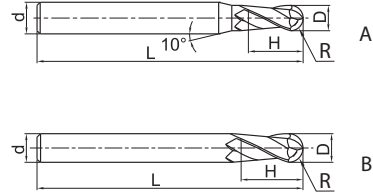

Article	*	Dimensions [mm]					Teeth	Geometry	Grade
		R	D	d (h6)	H	L			KMG406
EPM-2B-R1.5		1.5	3	6	6	50	2	A	●
EPM-2B-R2.0		2	4	6	8	50	2	A	●
EPM-2B-R2.5		2.5	5	6	10	50	2	A	●
EPM-2B-R3.0		3	6	6	12	50	2	B	●
EPM-2B-R4.0		4	8	8	16	60	2	B	●
EPM-2B-R5.0		5	10	10	20	75	2	B	●
EPM-2B-R6.0		6	12	12	24	75	2	B	●
EPM-2B-R7.0		7	14	14	28	75	2	B	●
EPM-2B-R8.0		8	16	16	32	100	2	B	●
EPM-2B-R10.0		10	20	20	40	100	2	B	●

- Ex stock ○ On demand
- * With internal cooling

Application field					
P	M	K	N	S	H
✓	✓	✓			✓

- ✓ Very suitable
- ✓ Suitable

A

Turning

B

Milling

C

Drilling

D

Technical Information

E

Index

System code > B278

Cutting data > B492

Nonstandard order > B541



A

Ball nose cutter High-performance machining

EPM-2B-W

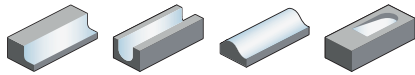

- Type of shank DIN 6535HB
- Centre cutting
- Helix angle 30°

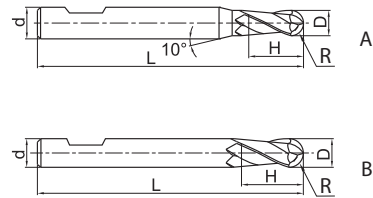

Turning

B

Milling

C

Drilling

Article	*	Dimensions [mm]					Teeth	Geometry	Grade
		R	D	d (h6)	H	L			KMG406
EPM-2B-R1.5-W		1.5	3	6	4	50	2	A	●
EPM-2B-R2.0-W		2	4	6	5	54	2	A	●
EPM-2B-R2.5-W		2.5	5	6	6	54	2	A	●
EPM-2B-R3.0-W		3	6	6	7	54	2	B	●
EPM-2B-R4.0-W		4	8	8	9	58	2	B	●
EPM-2B-R5.0-W		5	10	10	11	66	2	B	●
EPM-2B-R6.0-W		6	12	12	12	73	2	B	●
EPM-2B-R8.0-W		8	16	16	16	83	2	B	●
EPM-2B-R10.0-W		10	20	20	20	92	2	B	●

● Ex stock ○ On demand

* With internal cooling

D

Technical Information

E

Index

Application field						
P	M	K	N	S	H	
✓	✓	✓			✓	✓ Very suitable ✓ Suitable

System code > B278

Cutting data > B492

Nonstandard order > B541

Ball nose cutter long shank **High-performance machining**

EPM-2BL

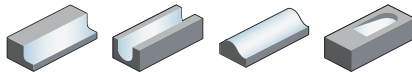

- Factory standard
- Centre cutting
- Helix angle 30°

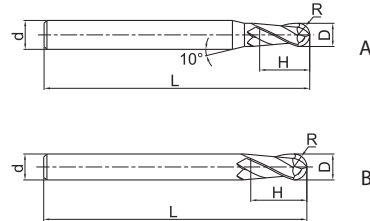

Article	*	Dimensions [mm]					Teeth	Geometry	Grade
		R	D	d (h6)	H	L			KMG406
EPM-2BL-R1.5		1.5	3	6	6	75	2	A	●
EPM-2BL-R2.0		2	4	6	8	75	2	A	●
EPM-2BL-R2.5		2.5	5	6	10	75	2	A	●
EPM-2BL-R3.0		3	6	6	12	75	2	B	●
EPM-2BL-R4.0		4	8	8	16	100	2	B	●
EPM-2BL-R5.0		5	10	10	20	100	2	B	●
EPM-2BL-R6.0		6	12	12	24	100	2	B	●
EPM-2BL-R7.0		7	14	14	28	100	2	B	●
EPM-2BL-R8.0		8	16	16	32	150	2	B	●
EPM-2BL-R10.0		10	20	20	40	150	2	B	●

- Ex stock ○ On demand
- * With internal cooling

Application field					
P	M	K	N	S	H
✓	✓	✓			✓

- ✓ Very suitable
- ✓ Suitable

A

Turning

B

Milling

C

Drilling

D

Technical Information

E

Index

System code > B278

Cutting data > B492

Nonstandard order > B541



A

Ball nose cutter long shank High-performance machining

EPM-2BL-W

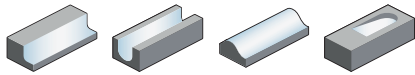

- Type of shank DIN 6535HB
- Centre cutting
- Helix angle 30°

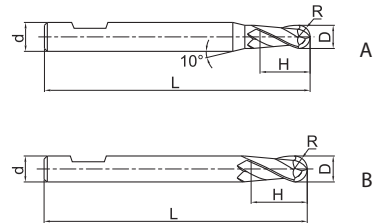

Turning

B

Milling

Article	*	Dimensions [mm]					Teeth	Geometry	Grade
		R	D	d (h6)	H	L			KMG406
EPM-2BL-R1.5-W		1.5	3	6	4	57	2	A	●
EPM-2BL-R2.0-W		2	4	6	5	57	2	A	●
EPM-2BL-R2.5-W		2.5	5	6	6	57	2	A	●
EPM-2BL-R3.0-W		3	6	6	7	57	2	B	●
EPM-2BL-R4.0-W		4	8	8	9	63	2	B	●
EPM-2BL-R5.0-W		5	10	10	11	72	2	B	●
EPM-2BL-R6.0-W		6	12	12	12	83	2	B	●
EPM-2BL-R8.0-W		8	16	16	16	92	2	B	●
EPM-2BL-R10.0-W		10	20	20	20	104	2	B	●

● Ex stock ○ On demand

* With internal cooling

C

Drilling

Application field

P	M	K	N	S	H
✓	✓	✓			✓

- ✓ Very suitable
- ✓ Suitable

D

Technical Information

E

Index

System code > B278

Cutting data > B492

Nonstandard order > B541

Ball nose cutter **High-performance machining**

EPM-4B

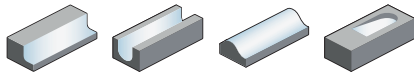

- Factory standard
- Centre cutting
- Helix angle 30°

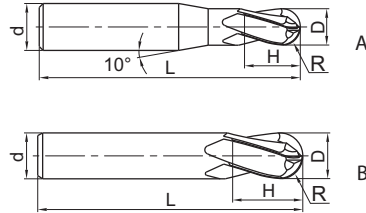
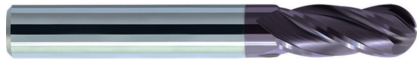

Article	*	Dimensions [mm]					Teeth	Geometry	Grade
		R	D	d (h6)	H	L			KMG406
EPM-4B-R1.5		1.5	3	6	6	50	4	A	●
EPM-4B-R2.0		2	4	6	8	50	4	A	●
EPM-4B-R2.5		2.5	5	6	10	50	4	A	●
EPM-4B-R3.0		3	6	6	12	50	4	B	●
EPM-4B-R4.0		4	8	8	16	60	4	B	●
EPM-4B-R5.0		5	10	10	20	75	4	B	●
EPM-4B-R6.0		6	12	12	24	75	4	B	●
EPM-4B-R7.0		7	14	14	28	75	4	B	●
EPM-4B-R8.0		8	16	16	32	100	4	B	●
EPM-4B-R9.0		9	18	18	36	100	4	B	●
EPM-4B-R10.0		10	20	20	40	100	4	B	●

● Ex stock ○ On demand

* With internal cooling

Application field					
P	M	K	N	S	H
✓	✓	✓			✓

✓ Very suitable

✓ Suitable

A

Turning

B

Milling

C

Drilling

D

Technical Information

E

Index

System code > B278

Cutting data > B492

Nonstandard order > B541



A

Ball nose cutter High-performance machining

EPM-4B-W

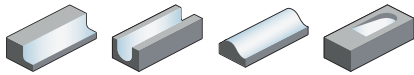

- Type of shank DIN 6535HB
- Centre cutting
- Helix angle 30°

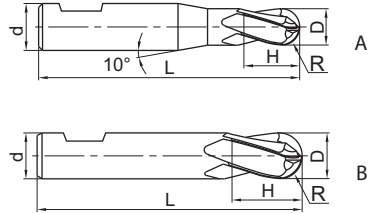

Turning

B

Milling

Article	*	Dimensions [mm]					Teeth	Geometry	Grade
		R	D	d (h6)	H	L			KMG406
EPM-4B-R1.5-W	*	1.5	3	6	4	50	4	A	●
EPM-4B-R2.0-W		2	4	6	5	54	4	A	●
EPM-4B-R2.5-W		2.5	5	6	6	54	4	A	●
EPM-4B-R3.0-W		3	6	6	7	54	4	B	●
EPM-4B-R4.0-W		4	8	8	9	58	4	B	●
EPM-4B-R5.0-W		5	10	10	11	66	4	B	●
EPM-4B-R6.0-W		6	12	12	12	73	4	B	●
EPM-4B-R7.0-W		7	14	14	14	75	4	B	●
EPM-4B-R8.0-W		8	16	16	16	83	4	B	●
EPM-4B-R9.0-W		9	18	18	18	84	4	B	●
EPM-4B-R10.0-W		10	20	20	20	92	4	B	●

● Ex stock ○ On demand

* With internal cooling

C

Drilling

D

Technical Information

E

Index

Application field

P	M	K	N	S	H
✓	✓	✓			✓

✓ Very suitable

✓ Suitable

System code > B278

Cutting data > B492

Nonstandard order > B541

Ball nose cutter long shank **High-performance machining**

EPM-4BL

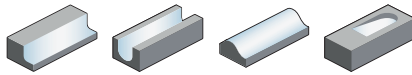

- Factory standard
- Centre cutting
- Helix angle 30°

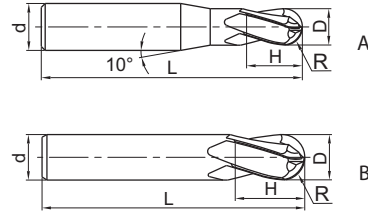

Article	*	Dimensions [mm]					Teeth	Geometry	Grade
		R	D	d (h6)	H	L			KMG406
EPM-4BL-R1.5		1.5	3	6	6	75	4	A	●
EPM-4BL-R2.0		2	4	6	8	75	4	A	●
EPM-4BL-R2.5		2.5	5	6	10	75	4	A	●
EPM-4BL-R3.0		3	6	6	12	75	4	B	●
EPM-4BL-R4.0		4	8	8	16	100	4	B	●
EPM-4BL-R5.0		5	10	10	20	100	4	B	●
EPM-4BL-R6.0		6	12	12	24	100	4	B	●
EPM-4BL-R7.0		7	14	14	28	100	4	B	●
EPM-4BL-R8.0		8	16	16	32	150	4	B	●
EPM-4BL-R10.0		10	20	20	40	150	4	B	●

- Ex stock ○ On demand
- * With internal cooling

Application field					
P	M	K	N	S	H
✓	✓	✓			✓

- ✓ Very suitable
- ✓ Suitable

A

Turning

B

Milling

C

Drilling

D

Technical Information

E

Index

System code > B278

Cutting data > B492

Nonstandard order > B541



A

Ball nose cutter long shank High-performance machining

EPM-4BL-W

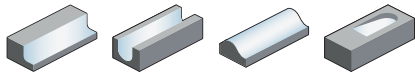

- Type of shank DIN 6535HB
- Centre cutting
- Helix angle 30°

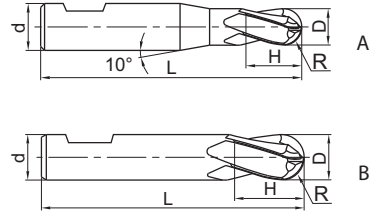

Turning

B

Milling

Article	*	Dimensions [mm]					Teeth	Geometry	Grade
		R	D	d (h6)	H	L			KMG406
EPM-4BL-R1.5-W		1.5	3	6	4	57	4	A	●
EPM-4BL-R2.0-W		2	4	6	5	57	4	A	●
EPM-4BL-R2.5-W		2.5	5	6	6	57	4	A	●
EPM-4BL-R3.0-W		3	6	6	7	57	4	B	●
EPM-4BL-R4.0-W		4	8	8	9	63	4	B	●
EPM-4BL-R5.0-W		5	10	10	11	72	4	B	●
EPM-4BL-R6.0-W		6	12	12	12	83	4	B	●
EPM-4BL-R8.0-W		8	16	16	16	92	4	B	●
EPM-4BL-R10.0-W		10	20	20	20	104	4	B	●

● Ex stock ○ On demand

* With internal cooling

C

Drilling

Application field

P	M	K	N	S	H
✓	✓	✓			✓

- ✓ Very suitable
- ✓ Suitable

D

Technical Information

E

Index

System code > B278

Cutting data > B492

Nonstandard order > B541

End mill **High-performance machining**

VPM-4E

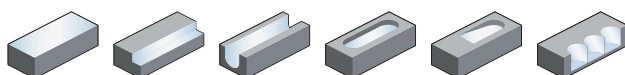

- Factory standard
- Centre cutting
- Helix angle 36°/38°

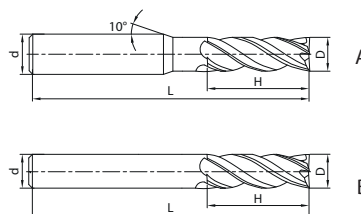

Article	*	Dimensions [mm]				Teeth	Geometry	Grade
		D	d (h6)	H	L			KMG406
VPM-4E-D3.0		3	6	8	50	4	A	●
VPM-4E-D4.0		4	6	11	50	4	A	●
VPM-4E-D5.0		5	6	13	50	4	A	●
VPM-4E-D6.0		6	6	16	50	4	B	●
VPM-4E-D7.0		7	8	20	60	4	A	●
VPM-4E-D8.0		8	8	20	60	4	B	●
VPM-4E-D9.0		9	10	22	75	4	A	●
VPM-4E-D10.0		10	10	25	75	4	B	●
VPM-4E-D11.0		11	12	26	75	4	A	●
VPM-4E-D12.0		12	12	30	75	4	B	●
VPM-4E-D14.0		14	14	32	75	4	B	●
VPM-4E-D16.0		16	16	45	100	4	B	●
VPM-4E-D18.0		18	18	45	100	4	B	●
VPM-4E-D20.0		20	20	45	100	4	B	●

● Ex stock ○ On demand

* With internal cooling

Application field

P	M	K	N	S	H
✓	✓	✓			✓

✓ Very suitable

✓ Suitable

System code > B278

Cutting data > B492

Nonstandard order > B541



Notes

A

Turning

B

Milling

C

Drilling

D

Technical
Information

E

Index

End mill **Hard machining**

HM-2E

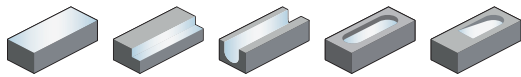

- Factory standard
- Centre cutting
- Helix angle 35°

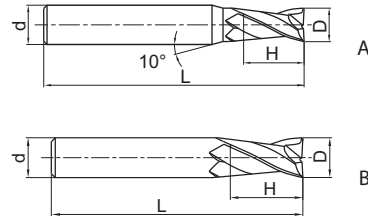

Article	*	Dimensions [mm]				Teeth	Geometry	Grade
		D	d (h6)	H	L			KMG555
HM-2E-D1.0S		1	4	3	50	2	A	●
HM-2E-D1.5S		1.5	4	4	50	2	A	●
HM-2E-D2.0S		2	4	6	50	2	A	●
HM-2E-D2.5S		2.5	4	8	50	2	A	●
HM-2E-D3.0S		3	4	8	50	2	A	●
HM-2E-D4.0S		4	4	11	50	2	B	●
HM-2E-D1.0		1	6	3	50	2	A	●
HM-2E-D1.5		1.5	6	4	50	2	A	●
HM-2E-D2.0		2	6	6	50	2	A	●
HM-2E-D2.5		2.5	6	8	50	2	A	●
HM-2E-D3.0		3	6	8	50	2	A	●
HM-2E-D3.5		3.5	6	10	50	2	A	●
HM-2E-D4.0		4	6	11	50	2	A	●
HM-2E-D4.5		4.5	6	11	50	2	A	●
HM-2E-D5.0		5	6	13	50	2	A	●
HM-2E-D5.5		5.5	6	16	50	2	A	●
HM-2E-D6.0		6	6	16	50	2	B	●
HM-2E-D7.0		7	8	20	60	2	A	●
HM-2E-D8.0		8	8	20	60	2	B	●
HM-2E-D9.0		9	10	22	75	2	A	●
HM-2E-D10.0		10	10	25	75	2	B	●
HM-2E-D11.0		11	12	26	75	2	A	○
HM-2E-D12.0		12	12	30	75	2	B	●
HM-2E-D14.0		14	14	32	100	2	B	●
HM-2E-D16.0		16	16	45	100	2	B	●
HM-2E-D18.0		18	18	45	100	2	B	○
HM-2E-D20.0		20	20	45	100	2	B	●

● Ex stock ○ On demand

* With internal cooling

Application field					
P	M	K	N	S	H
					✓

- ✓ Very suitable
- ✓ Suitable

System code > B278 Cutting data > B492 Nonstandard order > B541



A

Turning

B

Milling

C

Drilling

D

Technical Information

E

Index

A

End mill short cutting edge Hard machining

HM-2EFP

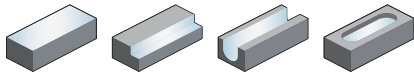

- Factory standard
- Centre cutting
- Helix angle 35°

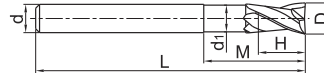

Turning

B

Article	*	Dimensions [mm]						Teeth	Grade
		D	d (h6)	d ₁	H	M	L		KMG555
HM-2EFP-D6.0		6	6	5.8	9	30	75	2	○
HM-2EFP-D8.0		8	8	7.8	12	40	100	2	○
HM-2EFP-D10.0		10	10	9.6	15	50	100	2	○
HM-2EFP-D12.0		12	12	11.5	18	50	100	2	○
HM-2EFP-D16.0		16	16	15.5	24	50	150	2	○
HM-2EFP-D20.0		20	20	19.5	30	60	150	2	○

- Ex stock ○ On demand
- * With internal cooling

Milling

C

Application field					
P	M	K	N	S	H
					✓

- ✓ Very suitable
- ✓ Suitable

Drilling

D

Technical Information

E

Index

System code > B278

Cutting data > B492

Nonstandard order > B541

End mill **Hard machining**

HM-2EP

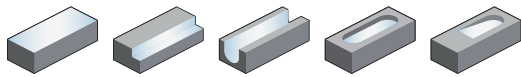

- Straight shank
- Centre cutting
- Helix angle 35°

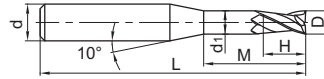

Article	*	Dimensions [mm]						Teeth	Grade KMG555
		D	d (h6)	d ₁	H	M	L		
HM-2EP-D0.5-M04		0.5	4	0.45	0.7	4	50	2	●
HM-2EP-D0.5-M06		0.5	4	0.45	0.7	6	50	2	●
HM-2EP-D0.5-M08		0.5	4	0.45	0.7	8	50	2	●
HM-2EP-D0.8-M04		0.8	4	0.75	1.2	4	50	2	●
HM-2EP-D0.8-M06		0.8	4	0.75	1.2	6	50	2	●
HM-2EP-D0.8-M08		0.8	4	0.75	1.2	8	50	2	●
HM-2EP-D0.8-M10		0.8	4	0.75	1.2	10	50	2	●
HM-2EP-D1.0-M04		1	4	0.95	1.5	4	50	2	●
HM-2EP-D1.0-M06		1	4	0.95	1.5	6	50	2	●
HM-2EP-D1.0-M08		1	4	0.95	1.5	8	50	2	●
HM-2EP-D1.0-M10		1	4	0.95	1.5	10	50	2	●
HM-2EP-D1.0-M12		1	4	0.95	1.5	12	50	2	●
HM-2EP-D1.0-M14		1	4	0.95	1.5	14	50	2	●
HM-2EP-D1.2-M06		1.2	4	1.15	1.8	6	50	2	●
HM-2EP-D1.2-M08		1.2	4	1.15	1.8	8	50	2	●
HM-2EP-D1.2-M10		1.2	4	1.15	1.8	10	50	2	●
HM-2EP-D1.2-M12		1.2	4	1.15	1.8	12	50	2	●
HM-2EP-D1.5-M06		1.5	4	1.45	2.3	6	50	2	●
HM-2EP-D1.5-M08		1.5	4	1.45	2.3	8	50	2	●
HM-2EP-D1.5-M10		1.5	4	1.45	2.3	10	50	2	●
HM-2EP-D1.5-M12		1.5	4	1.45	2.3	12	50	2	●
HM-2EP-D1.5-M14		1.5	4	1.45	2.3	14	50	2	●
HM-2EP-D2.0-M06		2	4	1.95	3	6	50	2	●
HM-2EP-D2.0-M08		2	4	1.95	3	8	50	2	●
HM-2EP-D2.0-M10		2	4	1.95	3	10	50	2	●
HM-2EP-D2.0-M12		2	4	1.95	3	12	50	2	●
HM-2EP-D2.0-M14		2	4	1.95	3	14	50	2	●
HM-2EP-D2.0-M16		2	4	1.95	3	16	50	2	●
HM-2EP-D2.5-M08		2.5	4	2.4	3.7	8	50	2	●
HM-2EP-D2.5-M10		2.5	4	2.4	3.7	10	50	2	●
HM-2EP-D2.5-M12		2.5	4	2.4	3.7	12	50	2	●
HM-2EP-D2.5-M14		2.5	4	2.4	3.7	14	50	2	●
HM-2EP-D2.5-M16		2.5	4	2.4	3.7	16	60	2	●
HM-2EP-D2.5-M18		2.5	4	2.4	3.7	18	60	2	●
HM-2EP-D2.5-M20		2.5	4	2.4	3.7	20	60	2	●
HM-2EP-D3.0-M06		3	6	2.85	4.5	6	50	2	●
HM-2EP-D3.0-M08		3	6	2.85	4.5	8	50	2	●

● Ex stock ○ On demand

* With internal cooling

Application field					
P	M	K	N	S	H
					✓

✓ Very suitable

✓ Suitable

System code > B278 Cutting data > B492 Nonstandard order > B541



A

Turning

B

Milling

C

Drilling

D

Technical Information

E

Index

A

End mill

Hard machining

HM-2EP

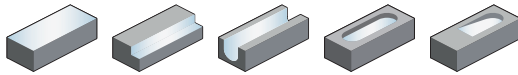

- Straight shank
- Centre cutting
- Helix angle 35°

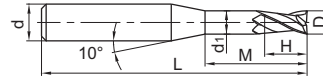

Turning

B

Article	*	Dimensions [mm]						Teeth	Grade
		D	d (h6)	d ₁	H	M	L		KMG555
HM-2EP-D3.0-M10		3	6	2.85	4.5	10	50	2	●
HM-2EP-D3.0-M12		3	6	2.85	4.5	12	50	2	●
HM-2EP-D3.0-M14		3	6	2.85	4.5	14	60	2	●
HM-2EP-D3.0-M16		3	6	2.85	4.5	16	60	2	●
HM-2EP-D3.0-M18		3	6	2.85	4.5	18	60	2	●
HM-2EP-D3.0-M20		3	6	2.85	4.5	20	60	2	●
HM-2EP-D4.0-M12		4	6	3.85	6	12	60	2	●
HM-2EP-D4.0-M16		4	6	3.85	6	16	60	2	●
HM-2EP-D4.0-M20		4	6	3.85	6	20	60	2	●
HM-2EP-D4.0-M25		4	6	3.85	6	25	60	2	●
HM-2EP-D5.0-M16		5	6	4.85	7.5	16	60	2	●
HM-2EP-D5.0-M25		5	6	4.85	7.5	25	70	2	●

● Ex stock ○ On demand

* With internal cooling

Milling

C

Application field

P	M	K	N	S	H
					✓

✓ Very suitable

✓ Suitable

Drilling

D

Technical Information

E

Index

System code > B278

Cutting data > B492

Nonstandard order > B541

End mill **Hard machining**

HM-2ES

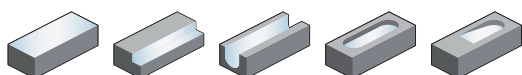

- Factory standard
- Centre cutting
- Helix angle 35°

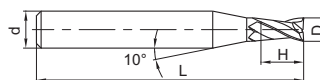

Article	*	Dimensions [mm]				Teeth	Grade
		D	d (h6)	H	L		KMG555
HM-2ES-D0.3		0.3	4	0.6	50	2	●
HM-2ES-D0.4		0.4	4	0.8	50	2	●
HM-2ES-D0.5		0.5	4	1	50	2	●
HM-2ES-D0.6		0.6	4	1.2	50	2	●
HM-2ES-D0.7		0.7	4	1.4	50	2	●
HM-2ES-D0.8		0.8	4	1.6	50	2	●
HM-2ES-D0.9		0.9	4	1.8	50	2	●
HM-2ES-D1.0		1	4	2	50	2	●
HM-2ES-D1.1		1.1	4	2	50	2	●
HM-2ES-D1.2		1.2	4	2.5	50	2	●
HM-2ES-D1.3		1.3	4	2.5	50	2	●
HM-2ES-D1.4		1.4	4	3	50	2	●
HM-2ES-D1.5		1.5	4	3	50	2	●
HM-2ES-D1.6		1.6	4	3.5	50	2	●
HM-2ES-D1.7		1.7	4	3.5	50	2	●
HM-2ES-D1.8		1.8	4	4	50	2	●
HM-2ES-D1.9		1.9	4	4	50	2	●
HM-2ES-D2.0		2	4	4	50	2	●
HM-2ES-D2.1		2.1	4	4	50	2	●
HM-2ES-D2.2		2.2	4	4.5	50	2	●
HM-2ES-D2.3		2.3	4	4.5	50	2	●
HM-2ES-D2.4		2.4	4	5	50	2	●
HM-2ES-D2.5		2.5	4	5	50	2	●
HM-2ES-D2.6		2.6	4	5	50	2	●
HM-2ES-D2.7		2.7	4	5.5	50	2	●
HM-2ES-D2.8		2.8	4	5.5	50	2	●
HM-2ES-D2.9		2.9	4	6	50	2	●
HM-2ES-D3.0		3	4	6	50	2	●

● Ex stock ○ On demand

* With internal cooling

Application field					
P	M	K	N	S	H
					✓

✓ Very suitable

✓ Suitable

System code > B278

Cutting data > B492

Nonstandard order > B541



A

End mill

Hard machining

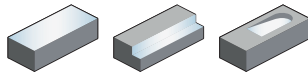

HM-4E

- Factory standard
- Centre cutting
- Helix angle 45°

Turning

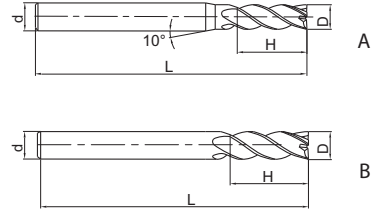

B

Milling

Article	*	Dimensions [mm]				Teeth	Geometry	Grade
		D	d (h6)	H	L			KMG555
HM-4E-D1.0S		1	4	3	50	4	A	●
HM-4E-D1.5S		1.5	4	4	50	4	A	●
HM-4E-D2.0S		2	4	6	50	4	A	●
HM-4E-D2.5S		2.5	4	8	50	4	A	●
HM-4E-D3.0S		3	4	8	50	4	A	●
HM-4E-D4.0S		4	4	11	50	4	B	●
HM-4E-D1.0		1	6	3	50	4	A	●
HM-4E-D1.5		1.5	6	4	50	4	A	●
HM-4E-D2.0		2	6	6	50	4	A	●
HM-4E-D2.5		2.5	6	8	50	4	A	●
HM-4E-D3.0		3	6	8	50	4	A	●
HM-4E-D3.5		3.5	6	10	50	4	A	●
HM-4E-D4.0		4	6	11	50	4	A	●
HM-4E-D4.5		4.5	6	11	50	4	A	●
HM-4E-D5.0		5	6	13	50	4	A	●
HM-4E-D5.5		5.5	6	16	50	4	A	●
HM-4E-D6.0		6	6	16	50	4	B	●
HM-4E-D7.0		7	8	20	60	4	A	●
HM-4E-D8.0		8	8	20	60	4	B	●
HM-4E-D9.0		9	10	22	75	4	A	●
HM-4E-D10.0		10	10	25	75	4	B	●
HM-4E-D11.0		11	12	26	75	4	A	●
HM-4E-D12.0		12	12	30	75	4	B	●
HM-4E-D14.0		14	14	32	75	4	B	●
HM-4E-D16.0		16	16	45	100	4	B	●
HM-4E-D18.0		18	18	45	100	4	B	●
HM-4E-D20.0		20	20	45	100	4	B	●

● Ex stock ○ On demand

* With internal cooling

C

Drilling

D

Technical Information

E

Index

Application field					
P	M	K	N	S	H
					✓

✓ Very suitable
 ✓ Suitable

System code > B278

Cutting data > B492

Nonstandard order > B541

End mill long shank

Hard machining

HM-4EL

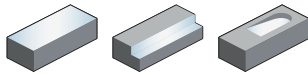

- Factory standard
- Centre cutting
- Helix angle 45°

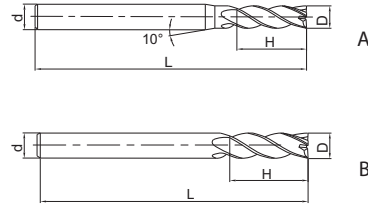

Article	*	Dimensions [mm]				Teeth	Geometry	Grade
		D	d (h6)	H	L			KMG555
HM-4EL-D3.0		3	6	12	75	4	A	●
HM-4EL-D4.0		4	6	15	75	4	A	●
HM-4EL-D5.0		5	6	20	75	4	A	●
HM-4EL-D6.0		6	6	20	75	4	B	●
HM-4EL-D8.0		8	8	25	100	4	B	●
HM-4EL-D10.0		10	10	30	100	4	B	●
HM-4EL-D12.0		12	12	35	100	4	B	●
HM-4EL-D14.0		14	14	40	100	4	B	●
HM-4EL-D16.0		16	16	50	150	4	B	●
HM-4EL-D20.0		20	20	55	150	4	B	●

● Ex stock ○ On demand

* With internal cooling

Application field					
P	M	K	N	S	H
					✓

✓ Very suitable

✓ Suitable

A

Turning

B

Milling

C

Drilling

D

Technical Information

E

Index

System code > B278

Cutting data > B492

Nonstandard order > B541



A

End mill short cutting edge Hard machining

Turning

HM-4EFP

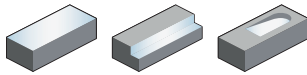

- Factory standard
- Centre cutting
- Helix angle 45°

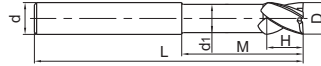

B

Milling

Article	*	Dimensions [mm]						Teeth	Grade
		D	d (h6)	d ₁	H	M	L		KMG555
HM-4EFP-D6.0		6	6	5.8	9	30	75	4	●
HM-4EFP-D8.0		8	8	7.8	12	40	100	4	●
HM-4EFP-D10.0		10	10	9.6	15	50	100	4	●
HM-4EFP-D12.0		12	12	11.5	18	50	100	4	●
HM-4EFP-D16.0		16	16	15.5	24	50	150	4	●
HM-4EFP-D20.0		20	20	19.5	30	60	150	4	○

● Ex stock ○ On demand

* With internal cooling

C

Drilling

Application field					
P	M	K	N	S	H
					✓

✓ Very suitable

✓ Suitable

D

Technical Information

E

Index

System code > B278

Cutting data > B492

Nonstandard order > B541

End mill long cutting edge **High-speed hard machining**

5502R55MHH

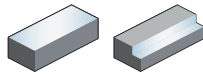

- Type of shank DIN 6535HA
- Non-centre cutting
- Helix angle 55°

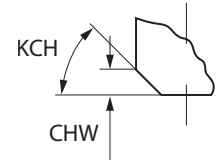
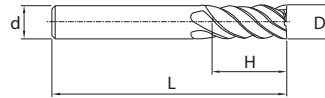

Article	*	Dimensions [mm]						Teeth	Grade	
		D	d (h6)	H	L	KCH	CHW		KMG405	KMG555
5502R55MHH-0300		3	6	8	57	0	0	4	●	●
5502R55MHH-0400		4	6	11	57	0	0	4	●	●
5502R55MHH-0500		5	6	13	57	0	0	5	●	●
5502R55MHH-0600		6	6	13	57	45	0.1	6	●	●
5502R55MHH-0800		8	8	19	63	45	0.1	6	●	●
5502R55MHH-1000		10	10	22	72	45	0.1	6	●	●
5502R55MHH-1200		12	12	26	83	45	0.1	6	●	●
5502R55MHH-1600		16	16	32	92	45	0.1	6	●	●
5502R55MHH-2000		20	20	38	104	45	0.1	8	●	●

● Ex stock ○ On demand

* With internal cooling

Application field					
P	M	K	N	S	H
					✓

- ✓ Very suitable
- ✓ Suitable

A

Turning

B

Milling

C

Drilling

D

Technical Information

E

Index

System code > B278

Cutting data > B492

Nonstandard order > B541



A

End mill

Hard machining

Turning

HM-6E

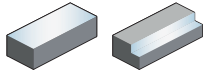

- Factory standard
- Non-centre cutting
- Helix angle 45°

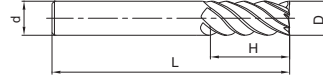

B

Milling

Article	*	Dimensions [mm]				Teeth	Grade
		D	d (h6)	H	L		KMG555
HM-6E-D6.0		6	6	18	60	6	○
HM-6E-D8.0		8	8	20	60	6	○
HM-6E-D10.0		10	10	30	75	6	○
HM-6E-D12.0		12	12	32	75	6	○
HM-6E-D16.0		16	16	40	100	6	○
HM-6E-D20.0		20	20	45	100	6	●

- Ex stock ○ On demand
- * With internal cooling

C

Drilling

Application field						
P	M	K	N	S	H	
					✓	✓ Suitable
						✓ Very suitable

D

Technical Information

E

Index

System code > B278

Cutting data > B492

Nonstandard order > B541

End mill long shank

Hard machining

HM-6EL

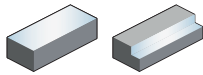

- Factory standard
- Non-centre cutting
- Helix angle 45°

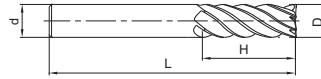

Article	*	Dimensions [mm]				Teeth	Grade
		D	d (h6)	H	L		KMG555
HM-6EL-D6.0		6	6	24	75	6	●
HM-6EL-D8.0		8	8	32	75	6	●
HM-6EL-D10.0		10	10	40	100	6	●
HM-6EL-D12.0		12	12	45	100	6	●
HM-6EL-D16.0		16	16	64	150	6	●
HM-6EL-D20.0		20	20	75	150	6	●

- Ex stock ○ On demand
- * With internal cooling

Application field					
P	M	K	N	S	H
					✓

- ✓ Very suitable
- ✓ Suitable

A

Turning

B

Milling

C

Drilling

D

Technical Information

E

Index

System code > B278

Cutting data > B492

Nonstandard order > B541



A

Ball nose cutter Hard machining

HM-2B

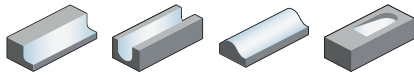

- Factory standard
- Centre cutting
- Helix angle 35°

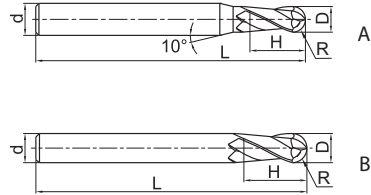

Turning

B

Milling

C

Drilling

D

Technical Information

Article	*	Dimensions [mm]					Teeth	Geometry	Grade
		R	D	d (h6)	H	L			KMG555
HM-2B-R0.5S		0.5	1	4	2	50	2	A	●
HM-2B-R0.75S		0.75	1.5	4	3	50	2	A	●
HM-2B-R1.0S		1	2	4	4	50	2	A	●
HM-2B-R1.25S		1.25	2.5	4	5	50	2	A	●
HM-2B-R1.5S		1.5	3	4	6	50	2	A	●
HM-2B-R2.0S		2	4	4	8	50	2	B	●
HM-2B-R0.5		0.5	1	6	2	50	2	A	●
HM-2B-R0.75		0.75	1.5	6	3	50	2	A	●
HM-2B-R1.0		1	2	6	4	50	2	A	●
HM-2B-R1.25		1.25	2.5	6	5	50	2	A	●
HM-2B-R1.5		1.5	3	6	6	50	2	A	●
HM-2B-R1.75		1.75	3.5	6	8	50	2	A	●
HM-2B-R2.0		2	4	6	8	50	2	A	●
HM-2B-R2.5		2.5	5	6	10	50	2	A	●
HM-2B-R2.75		2.75	5.5	6	12	50	2	A	●
HM-2B-R3.0		3	6	6	12	50	2	B	●
HM-2B-R3.5		3.5	7	8	14	60	2	A	●
HM-2B-R4.0		4	8	8	16	60	2	B	●
HM-2B-R4.5		4.5	9	10	18	75	2	A	●
HM-2B-R5.0		5	10	10	20	75	2	B	●
HM-2B-R6.0		6	12	12	24	75	2	B	●
HM-2B-R7.0		7	14	14	28	75	2	B	●
HM-2B-R8.0		8	16	16	32	100	2	B	●
HM-2B-R10.0		10	20	20	40	100	2	B	●

● Ex stock ○ On demand

* With internal cooling

E

Index

Application field

P	M	K	N	S	H
					✓

✓ Very suitable

✓ Suitable

System code > B278

Cutting data > B492

Nonstandard order > B541

Ball nose cutter long shank **Hard machining**

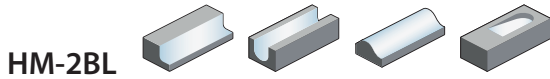

- Factory standard
- Centre cutting
- Helix angle 35°

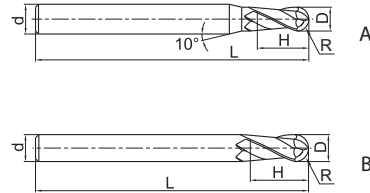

Article	*	Dimensions [mm]					Teeth	Geometry	Grade
		R	D	d (h6)	H	L			KMG555
HM-2BL-R1.0		1	2	6	4	75	2	A	●
HM-2BL-R1.25		1.25	2.5	6	6	75	2	A	●
HM-2BL-R1.5		1.5	3	6	6	75	2	A	●
HM-2BL-R1.75		1.75	3.5	6	8	75	2	A	●
HM-2BL-R2.0		2	4	6	8	75	2	A	●
HM-2BL-R2.5		2.5	5	6	10	75	2	A	●
HM-2BL-R2.75		2.75	5.5	6	12	75	2	A	●
HM-2BL-R3.0		3	6	6	12	75	2	B	●
HM-2BL-R3.5		3.5	7	8	14	75	2	A	●
HM-2BL-R4.0		4	8	8	16	100	2	B	●
HM-2BL-R4.5		4.5	9	10	18	100	2	A	●
HM-2BL-R5.0		5	10	10	20	100	2	B	●
HM-2BL-R6.0		6	12	12	24	100	2	B	●
HM-2BL-R7.0		7	14	14	28	100	2	B	●
HM-2BL-R8.0		8	16	16	32	150	2	B	●
HM-2BL-R10.0		10	20	20	40	150	2	B	●

● Ex stock ○ On demand

* With internal cooling

Application field					
P	M	K	N	S	H
					✓

- ✓ Very suitable
- ✓ Suitable

System code > B278

Cutting data > B492

Nonstandard order > B541



A

Turning

B

Milling

C

Drilling

D

Technical Information

E

Index

A

Ball nose cutter short cutting edge Hard machining

HM-2BFP

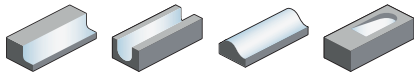

- Factory standard
- Centre cutting
- Helix angle 35°

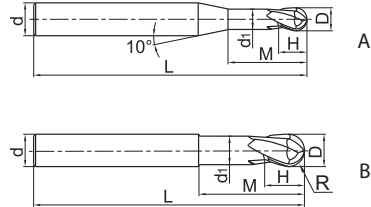
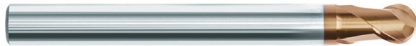

Turning

B

Milling

Article	*	Dimensions [mm]								Teeth	Geometry	Grade
		R	D	d (h6)	d ₁	H	M	L	KMG555			
HM-2BFP-R0.5		0.5	1	6	0.95	1	2.5	75	2	A	●	
HM-2BFP-R0.75		0.75	1.5	6	1.45	1.5	3	75	2	A	●	
HM-2BFP-R1.0		1	2	6	1.95	2	4	75	2	A	●	
HM-2BFP-R1.5		1.5	3	6	2.85	3	6	75	2	A	●	
HM-2BFP-R2.0		2	4	6	3.85	4	8	75	2	A	●	
HM-2BFP-R2.5		2.5	5	6	4.85	5	10	75	2	A	●	
HM-2BFP-R3.0		3	6	6	5.8	6	12	75	2	B	●	
HM-2BFP-R4.0		4	8	8	7.8	8	16	100	2	B	●	
HM-2BFP-R5.0		5	10	10	9.6	10	20	100	2	B	●	
HM-2BFP-R6.0		6	12	12	11.5	12	24	100	2	B	●	
HM-2BFP-R8.0		8	16	16	15.5	16	32	150	2	B	●	
HM-2BFP-R10.0		10	20	20	19.5	20	40	150	2	B	○	

● Ex stock ○ On demand

* With internal cooling

C

Drilling

D

Technical Information

E

Index

Application field

P	M	K	N	S	H
					✓

✓ Very suitable

✓ Suitable

System code > B278

Cutting data > B492

Nonstandard order > B541

Ball nose cutter **Hard machining**

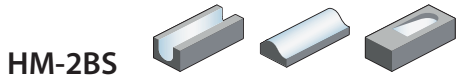

- Factory standard
- Centre cutting
- Helix angle 35°

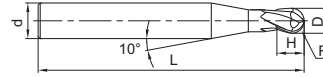

Article	*	Dimensions [mm]					Teeth	Grade
		R	D	d (h6)	H	L		KMG555
HM-2BS-R0.15		0.15	0.3	4	0.5	50	2	●
HM-2BS-R0.20		0.2	0.4	4	0.6	50	2	●
HM-2BS-R0.25		0.25	0.5	4	0.8	50	2	●
HM-2BS-R0.30		0.3	0.6	4	0.9	50	2	●
HM-2BS-R0.35		0.35	0.7	4	1	50	2	●
HM-2BS-R0.40		0.4	0.8	4	1.2	50	2	●
HM-2BS-R0.45		0.45	0.9	4	1.3	50	2	●
HM-2BS-R0.50		0.5	1	4	1.5	50	2	●
HM-2BS-R0.60		0.6	1.2	4	1.8	50	2	●
HM-2BS-R0.70		0.7	1.4	4	2	50	2	●
HM-2BS-R0.75		0.75	1.5	4	2.3	50	2	●
HM-2BS-R0.80		0.8	1.6	4	2.5	50	2	●
HM-2BS-R0.90		0.9	1.8	4	2.7	50	2	●
HM-2BS-R1.00		1	2	4	3	50	2	●
HM-2BS-R1.25		1.25	2.5	4	3.7	50	2	●
HM-2BS-R1.50		1.5	3	4	4.5	50	2	●

- Ex stock ○ On demand
- * With internal cooling

Application field					
P	M	K	N	S	H
					✓

- ✓ Very suitable
- ✓ Suitable

A

Turning

B

Milling

C

Drilling

D

Technical Information

E

Index

A

End mill

Hard machining

Turning

HM-2BP

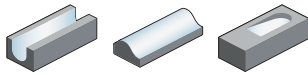

- Straight shank
- Centre cutting
- Helix angle 35°

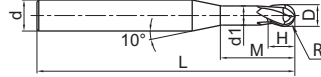

B

Milling

Article	*	Dimensions [mm]							Teeth	Grade KMG555
		R	D	d (h6)	d ₁	H	M	L		
HM-2BP-R0.25-M04		0.25	0.5	4	0.45	0.7	4	50	2	●
HM-2BP-R0.25-M06		0.25	0.5	4	0.45	0.7	6	50	2	●
HM-2BP-R0.3-M04		0.3	0.6	4	0.55	0.9	4	50	2	●
HM-2BP-R0.3-M06		0.3	0.6	4	0.55	0.9	6	50	2	●
HM-2BP-R0.3-M08		0.3	0.6	4	0.55	0.9	8	50	2	●
HM-2BP-R0.4-M04		0.4	0.8	4	0.75	1.2	4	50	2	●
HM-2BP-R0.4-M06		0.4	0.8	4	0.75	1.2	6	50	2	●
HM-2BP-R0.4-M08		0.4	0.8	4	0.75	1.2	8	50	2	●
HM-2BP-R0.4-M10		0.4	0.8	4	0.75	1.2	10	50	2	●
HM-2BP-R0.5-M04		0.5	1	4	0.95	1.5	4	50	2	●
HM-2BP-R0.5-M06		0.5	1	4	0.95	1.5	6	50	2	●
HM-2BP-R0.5-M08		0.5	1	4	0.95	1.5	8	50	2	●
HM-2BP-R0.5-M10		0.5	1	4	0.95	1.5	10	50	2	●
HM-2BP-R0.5-M12		0.5	1	4	0.95	1.5	12	50	2	●
HM-2BP-R0.6-M06		0.6	1.2	4	1.15	1.8	6	50	2	●
HM-2BP-R0.6-M08		0.6	1.2	4	1.15	1.8	8	50	2	●
HM-2BP-R0.6-M12		0.6	1.2	4	1.15	1.8	12	50	2	●
HM-2BP-R0.6-M16		0.6	1.2	4	1.15	1.8	16	50	2	●
HM-2BP-R0.75-M08		0.75	1.5	4	1.45	2.3	8	50	2	●
HM-2BP-R0.75-M12		0.75	1.5	4	1.45	2.3	12	50	2	●
HM-2BP-R0.75-M16		0.75	1.5	4	1.45	2.3	16	50	2	●
HM-2BP-R1.0-M06		1	2	4	1.95	3	6	50	2	●
HM-2BP-R1.0-M08		1	2	4	1.95	3	8	50	2	●
HM-2BP-R1.0-M10		1	2	4	1.95	3	10	50	2	●
HM-2BP-R1.0-M12		1	2	4	1.95	3	12	50	2	●
HM-2BP-R1.0-M16		1	2	4	1.95	3	16	50	2	●
HM-2BP-R1.0-M20		1	2	4	1.95	3	20	50	2	●
HM-2BP-R1.25-M08		1.25	2.5	4	2.4	3.7	8	50	2	●
HM-2BP-R1.25-M12		1.25	2.5	4	2.4	3.7	12	50	2	●
HM-2BP-R1.25-M16		1.25	2.5	4	2.4	3.7	16	60	2	●
HM-2BP-R1.25-M20		1.25	2.5	4	2.4	3.7	20	60	2	●
HM-2BP-R1.5-M08		1.5	3	6	2.85	4.5	8	50	2	●
HM-2BP-R1.5-M10		1.5	3	6	2.85	4.5	10	50	2	●
HM-2BP-R1.5-M12		1.5	3	6	2.85	4.5	12	50	2	●
HM-2BP-R1.5-M16		1.5	3	6	2.85	4.5	16	60	2	●
HM-2BP-R1.5-M20		1.5	3	6	2.85	4.5	20	60	2	●
HM-2BP-R2.0-M10		2	4	6	3.85	6	10	60	2	●

● Ex stock ○ On demand

* With internal cooling

C

Drilling

D

Technical Information

E

Index

Application field

P	M	K	N	S	H
					✓

✓ Very suitable

✓ Suitable

System code > B278

Cutting data > B492

Nonstandard order > B541

End mill **Hard machining**

HM-2BP

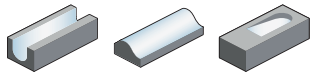

- Straight shank
- Centre cutting
- Helix angle 35°

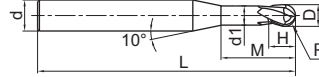

Article	*	Dimensions [mm]							Teeth	Grade
		R	D	d (h6)	d ₁	H	M	L		KMG555
HM-2BP-R2.0-M16		2	4	6	3.85	6	16	60	2	●
HM-2BP-R2.0-M20		2	4	6	3.85	6	20	60	2	●
HM-2BP-R2.0-M25		2	4	6	3.85	6	25	60	2	●
HM-2BP-R2.5-M16		2.5	5	6	4.85	7.5	16	60	2	●
HM-2BP-R2.5-M25		2.5	5	6	4.85	7.5	25	70	2	●

● Ex stock ○ On demand

* With internal cooling

Application field					
P	M	K	N	S	H
					✓

- ✓ Very suitable
- ✓ Suitable

System code > B278

Cutting data > B492

Nonstandard order > B541



A

Ball nose cutter Hard machining

HM-4B

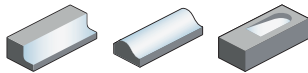

- Factory standard
- Centre cutting
- Helix angle 35°

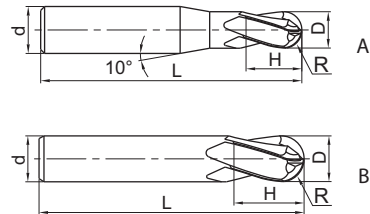
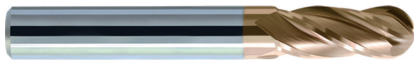

Turning

B

Milling

C

Drilling

Article	*	Dimensions [mm]					Teeth	Geometry	Grade
		R	D	d (h6)	H	L			KMG555
HM-4B-R1.5		1.5	3	6	6	50	4	A	●
HM-4B-R2.0		2	4	6	8	50	4	A	●
HM-4B-R2.5		2.5	5	6	10	50	4	A	●
HM-4B-R3.0		3	6	6	12	50	4	B	●
HM-4B-R4.0		4	8	8	16	60	4	B	●
HM-4B-R5.0		5	10	10	20	75	4	B	●
HM-4B-R6.0		6	12	12	24	75	4	B	●
HM-4B-R7.0		7	14	14	28	75	4	B	●
HM-4B-R8.0		8	16	16	32	100	4	B	●
HM-4B-R9.0		9	18	18	36	100	4	B	●
HM-4B-R10.0		10	20	20	40	100	4	B	●

● Ex stock ○ On demand

* With internal cooling

D

Technical Information

E

Index

Application field

P	M	K	N	S	H
					✓

✓ Very suitable

✓ Suitable

System code > B278

Cutting data > B492

Nonstandard order > B541

Ball nose cutter long shank **Hard machining**

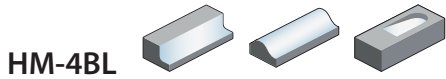

- Factory standard
- Centre cutting
- Helix angle 35°

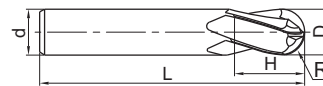
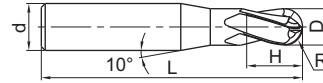

Article	*	Dimensions [mm]					Teeth	Geometry	Grade
		R	D	d (h6)	H	L			KMG555
HM-4BL-R1.5		1.5	3	6	6	75	4	A	●
HM-4BL-R2.0		2	4	6	8	75	4	A	●
HM-4BL-R2.5		2.5	5	6	10	75	4	A	●
HM-4BL-R3.0		3	6	6	12	75	4	B	●
HM-4BL-R4.0		4	8	8	16	100	4	B	●
HM-4BL-R5.0		5	10	10	20	100	4	B	●
HM-4BL-R6.0		6	12	12	24	100	4	B	●
HM-4BL-R7.0		7	14	14	28	100	4	B	●
HM-4BL-R8.0		8	16	16	32	150	4	B	●
HM-4BL-R9.0		9	18	18	36	150	4	B	●
HM-4BL-R10.0		10	20	20	40	150	4	B	●

● Ex stock ○ On demand

* With internal cooling

Application field					
P	M	K	N	S	H
					✓

✓ Very suitable

✓ Suitable

A

Turning

B

Milling

C

Drilling

D

Technical Information

E

Index

System code > B278

Cutting data > B492

Nonstandard order > B541



A

Torus mill

Hard machining

Turning

HM-4R

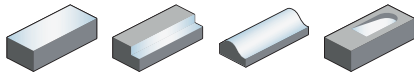

- Factory standard
- Centre cutting
- Helix angle 35°

B

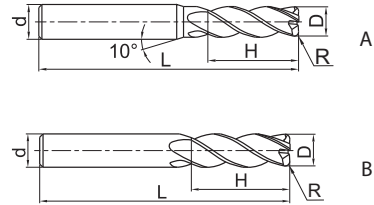

Milling

Article	*	Dimensions [mm]					Teeth	Geometry	Grade
		R	D	d (h6)	H	L			KMG555
HM-4R-D3.0R0.2		0.2	3	4	8	50	4	A	●
HM-4R-D4.0R0.3		0.3	4	4	10	50	4	B	●
HM-4R-D4.0R0.5		0.5	4	4	10	50	4	B	●
HM-4R-D5.0R0.5		0.5	5	6	13	50	4	A	●
HM-4R-D5.0R1.0		1	5	6	13	50	4	A	●
HM-4R-D6.0R0.5		0.5	6	6	16	50	4	B	●
HM-4R-D6.0R1.0		1	6	6	16	50	4	B	●
HM-4R-D8.0R0.5		0.5	8	8	20	60	4	B	●
HM-4R-D8.0R1.0		1	8	8	20	60	4	B	●
HM-4R-D10.0R0.5		0.5	10	10	25	75	4	B	●
HM-4R-D10.0R1.0		1	10	10	25	75	4	B	●
HM-4R-D10.0R2.0		2	10	10	25	75	4	B	●
HM-4R-D10.0R3.0		3	10	10	25	75	4	B	●
HM-4R-D12.0R0.5		0.5	12	12	30	75	4	B	●
HM-4R-D12.0R1.0		1	12	12	30	75	4	B	●
HM-4R-D12.0R2.0		2	12	12	30	75	4	B	●
HM-4R-D12.0R3.0		3	12	12	30	75	4	B	●

C

Drilling

D

- Ex stock ○ On demand
- * With internal cooling

Technical Information

Application field					
P	M	K	N	S	H
					✓

- ✓ Very suitable
- ✓ Suitable

E

Index

System code > B278

Cutting data > B492

Nonstandard order > B541

Torus mill short cutting edge

Hard machining

HM-4RF

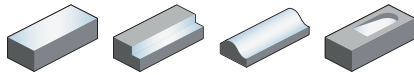

- Factory standard
- Centre cutting
- Helix angle 35°

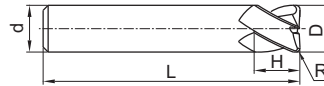

Article	*	Dimensions [mm]					Teeth	Grade
		R	D	d (h6)	H	L		KMG555
HM-4RF-D6.0R0.5		0.5	6	6	6	50	4	○
HM-4RF-D6.0R1.0		1	6	6	6	50	4	○
HM-4RF-D8.0R0.5		0.5	8	8	8	60	4	○
HM-4RF-D8.0R1.0		1	8	8	8	60	4	○
HM-4RF-D10.0R1.0		1	10	10	10	75	4	○
HM-4RF-D10.0R2.0		2	10	10	10	75	4	○
HM-4RF-D12.0R0.5		0.5	12	12	12	75	4	○
HM-4RF-D12.0R1.0		1	12	12	12	75	4	○
HM-4RF-D12.0R2.0		2	12	12	12	75	4	○

● Ex stock ○ On demand

* With internal cooling

Application field					
P	M	K	N	S	H
					✓

✓ Very suitable

✓ Suitable

System code > B278

Cutting data > B492

Nonstandard order > B541



A

Torus mill long shank Hard machining

HM-4RP

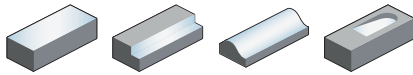

- Factory standard
- Centre cutting
- Helix angle 35°

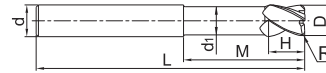

Turning

B

Article	*	Dimensions [mm]							Teeth	Grade	
		R	D	d (h6)	d ₁	H	M	L		KMG555	
HM-4RP-D6.0R0.5		0.5	6	6	5.8	6	18	75	4	○	
HM-4RP-D6.0R1.0		1	6	6	5.8	6	18	75	4	○	
HM-4RP-D8.0R0.5		0.5	8	8	7.8	8	24	100	4	○	
HM-4RP-D8.0R1.0		1	8	8	7.8	8	24	100	4	○	
HM-4RP-D10.0R0.5		0.5	10	10	9.6	10	30	100	4	○	
HM-4RP-D10.0R1.0		1	10	10	9.6	10	30	100	4	○	
HM-4RP-D10.0R2.0		2	10	10	9.6	10	30	100	4	○	
HM-4RP-D12.0R0.5		0.5	12	12	11.5	12	36	100	4	○	
HM-4RP-D12.0R1.0		1	12	12	11.5	12	36	100	4	○	
HM-4RP-D12.0R2.0		2	12	12	11.5	12	36	100	4	○	
HM-4RP-D16.0R1.0		1	16	16	15.5	16	40	150	4	●	
HM-4RP-D16.0R2.0		2	16	16	15.5	16	40	150	4	○	

● Ex stock ○ On demand

* With internal cooling

Milling

C

Application field

P	M	K	N	S	H
					✓

✓ Very suitable

✓ Suitable

Drilling

D

Technical Information

E

Index

System code > B278

Cutting data > B492

Nonstandard order > B541

End mill **General machining of non-ferrous metals**

5502R402NM

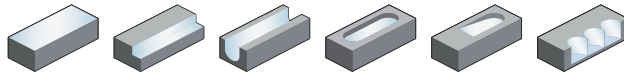

- Type of shank DIN 6535HA
- Centre cutting
- Helix angle 40°

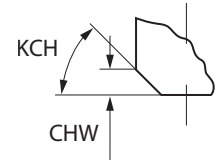
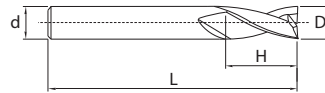

Article	*	Dimensions [mm]						Teeth	Grade YK30F
		D	d (h6)	H	L	KCH	CHW		
5502R402NM-0300		3	6	8	57	0	0	2	●
5502R402NM-0400		4	6	11	57	0	0	2	●
5502R402NM-0500		5	6	13	57	0	0	2	●
5502R402NM-0600		6	6	13	57	45	0.1	2	●
5502R402NM-0800		8	8	19	63	45	0.1	2	●
5502R402NM-1000		10	10	22	72	45	0.1	2	●
5502R402NM-1200		12	12	26	83	45	0.1	2	●
5502R402NM-1400		14	14	26	83	45	0.15	2	●
5502R402NM-1600		16	16	32	92	45	0.15	2	●
5502R402NM-1800		18	18	32	92	45	0.15	2	●
5502R402NM-2000		20	20	38	104	45	0.15	2	●

- Ex stock ○ On demand
- * With internal cooling

Application field					
P	M	K	N	S	H
			✓		

- ✓ Very suitable
- ✓ Suitable

A

Turning

B

Milling

C

Drilling

D

Technical Information

E

Index

System code > B278

Cutting data > B492

Nonstandard order > B541



A

End mill General machining of non-ferrous metals

NM-2E

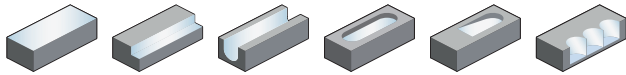

- Factory standard
- Centre cutting
- Helix angle 35°

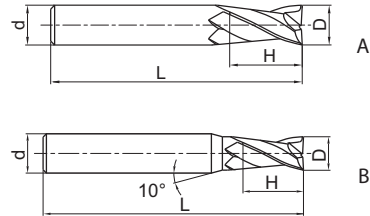

Turning

B

Milling

Article	*	Dimensions [mm]				Teeth	Geometry	Grade
		D	d (h6)	H	L			KMG309
NM-2E-D1.0		1	4	3	50	2	A	●
NM-2E-D2.0		2	4	6	50	2	A	●
NM-2E-D3.0		3	6	8	50	2	A	●
NM-2E-D4.0		4	6	11	50	2	A	●
NM-2E-D5.0		5	6	13	50	2	A	●
NM-2E-D6.0		6	6	16	50	2	B	●
NM-2E-D8.0		8	8	20	60	2	B	●
NM-2E-D10.0		10	10	25	75	2	B	●
NM-2E-D12.0		12	12	30	75	2	B	●

● Ex stock ○ On demand

* With internal cooling

C

Drilling

Application field

P	M	K	N	S	H
			✓		

✓ Very suitable

✓ Suitable

D

Technical Information

E

Index

System code > B278

Cutting data > B492

Nonstandard order > B541

End mill **General machining of non-ferrous metals**

NM-2EP

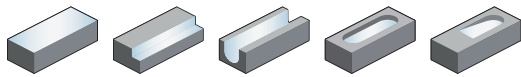

- Factory standard
- Centre cutting
- Helix angle 35°

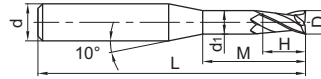

Article	*	Dimensions [mm]						Teeth	Grade
		D	d (h6)	d ₁	H	M	L		KMG309
NM-2EP-D0.5-M04		0.5	4	0.45	0.7	4	50	2	●
NM-2EP-D0.5-M08		0.5	4	0.45	0.7	8	50	2	●
NM-2EP-D0.5-M06		0.5	4	0.45	0.7	6	50	2	●
NM-2EP-D0.8-M10		0.8	4	0.75	1.2	10	50	2	●
NM-2EP-D0.8-M04		0.8	4	0.75	1.2	4	50	2	●
NM-2EP-D0.8-M08		0.8	4	0.75	1.2	8	50	2	●
NM-2EP-D0.8-M06		0.8	4	0.75	1.2	6	50	2	●
NM-2EP-D1.0-M08		1	4	0.95	1.5	8	50	2	●
NM-2EP-D1.0-M10		1	4	0.95	1.5	10	50	2	●
NM-2EP-D1.0-M14		1	4	0.95	1.5	14	50	2	●
NM-2EP-D1.0-M12		1	4	0.95	1.5	12	50	2	●
NM-2EP-D1.0-M06		1	4	0.95	1.5	6	50	2	●
NM-2EP-D1.0-M04		1	4	0.95	1.5	4	50	2	●
NM-2EP-D1.5-M08		1.5	4	1.45	2.3	8	50	2	●
NM-2EP-D1.5-M16		1.5	4	1.45	2.3	16	50	2	●
NM-2EP-D2.0-M16		2	4	1.95	3	16	50	2	●
NM-2EP-D2.0-M14		2	4	1.95	3	14	50	2	●
NM-2EP-D2.0-M08		2	4	1.95	3	8	50	2	●
NM-2EP-D2.0-M10		2	4	1.95	3	10	50	2	●
NM-2EP-D2.0-M12		2	4	1.95	3	12	50	2	●
NM-2EP-D2.0-M06		2	4	1.95	3	6	50	2	●
NM-2EP-D2.5-M10		2.5	4	2.4	3.7	10	50	2	●
NM-2EP-D2.5-M20		2.5	4	2.4	3.7	20	60	2	●
NM-2EP-D3.0-M20		3	6	2.85	4.5	20	60	2	●
NM-2EP-D3.0-M10		3	6	2.85	4.5	10	50	2	●
NM-2EP-D4.0-M25		4	6	3.85	6	25	60	2	●
NM-2EP-D4.0-M16		4	6	3.85	6	16	60	2	●
NM-2EP-D5.0-M25		5	6	4.85	7.5	25	70	2	●
NM-2EP-D5.0-M16		5	6	4.85	7.5	16	60	2	●

● Ex stock ○ On demand

* With internal cooling

Application field					
P	M	K	N	S	H
			✓		

✓ Very suitable

✓ Suitable

System code > B278

Cutting data > B492

Nonstandard order > B541



A

Turning

B

Milling

C

Drilling

D

Technical Information

E

Index

A

End mill General machining of non-ferrous metals

NM-4E

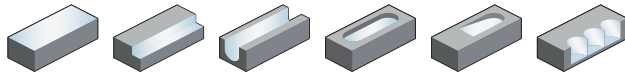

- Factory standard
- Centre cutting
- Helix angle 35°

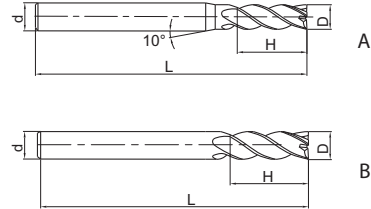

Turning

B

Milling

Article	*	Dimensions [mm]				Teeth	Geometry	Grade
		D	d (h6)	H	L			KMG309
NM-4E-D3.0		3	6	8	50	4	A	●
NM-4E-D4.0		4	6	11	50	4	A	●
NM-4E-D5.0		5	6	13	50	4	A	●
NM-4E-D6.0		6	6	16	50	4	B	●
NM-4E-D8.0		8	8	20	60	4	B	●
NM-4E-D10.0		10	10	25	75	4	B	●
NM-4E-D12.0		12	12	30	75	4	B	●

- Ex stock ○ On demand
- * With internal cooling

C

Drilling

Application field						
P	M	K	N	S	H	
			✓			✓ Very suitable
						✓ Suitable

D

Technical Information

E

Index

System code > B278

Cutting data > B492

Nonstandard order > B541

Ball nose cutter **General machining of non-ferrous metals**

NM-2B

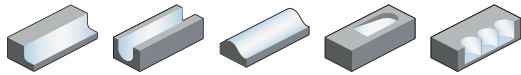

- Factory standard
- Centre cutting
- Helix angle 35°

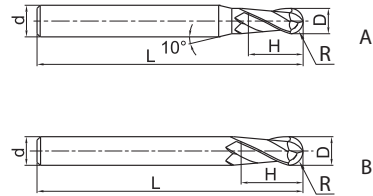

Article	*	Dimensions [mm]					Teeth	Geometry	Grade
		R	D	d (h6)	H	L			KMG309
NM-2B-R0.5		0.5	1	4	2	50	2	A	●
NM-2B-R0.75		0.75	1.5	4	3	50	2	A	●
NM-2B-R1.0		1	2	4	4	50	2	A	●
NM-2B-R1.25		1.25	2.5	4	5	50	2	A	●
NM-2B-R1.5		1.5	3	6	6	50	2	A	●
NM-2B-R1.75		1.75	3.5	6	8	50	2	A	●
NM-2B-R2.0		2	4	6	8	50	2	A	●
NM-2B-R2.5		2.5	5	6	10	50	2	A	●
NM-2B-R3.0		3	6	6	12	50	2	B	●
NM-2B-R4.0		4	8	8	16	60	2	B	●
NM-2B-R5.0		5	10	10	20	75	2	B	●
NM-2B-R6.0		6	12	12	24	75	2	B	●

● Ex stock ○ On demand

* With internal cooling

Application field					
P	M	K	N	S	H
			✓		

✓ Very suitable

✓ Suitable

System code > B278

Cutting data > B492

Nonstandard order > B541



Ball nose cutter General machining of non-ferrous metals

NM-2BP

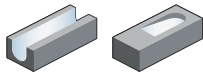

- Factory standard
- Centre cutting
- Helix angle 35°

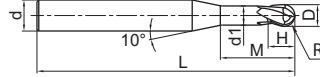

Article	*	Dimensions [mm]							Teeth	Grade
		R	D	d (h6)	d ₁	H	M	L		KMG309
NM-2BP-R0.25-M04		0.25	0.5	4	0.45	0.7	4	50	2	●
NM-2BP-R0.25-M06		0.25	0.5	4	0.45	0.7	6	50	2	●
NM-2BP-R0.3-M04		0.3	0.6	4	0.55	0.9	4	50	2	●
NM-2BP-R0.3-M06		0.3	0.6	4	0.55	0.9	6	50	2	●
NM-2BP-R0.3-M08		0.3	0.6	4	0.55	0.9	8	50	2	●
NM-2BP-R0.4-M04		0.4	0.8	4	0.75	1.2	4	50	2	●
NM-2BP-R0.4-M06		0.4	0.8	4	0.75	1.2	6	50	2	●
NM-2BP-R0.4-M08		0.4	0.8	4	0.75	1.2	8	50	2	●
NM-2BP-R0.4-M10		0.4	0.8	4	0.75	1.2	10	50	2	●
NM-2BP-R0.5-M04		0.5	1	4	0.95	1.5	4	50	2	●
NM-2BP-R0.5-M06		0.5	1	4	0.95	1.5	6	50	2	●
NM-2BP-R0.5-M08		0.5	1	4	0.95	1.5	8	50	2	●
NM-2BP-R0.5-M10		0.5	1	4	0.95	1.5	10	50	2	●
NM-2BP-R0.5-M12		0.5	1	4	0.95	1.5	12	50	2	●
NM-2BP-R0.75-M08		0.75	1.5	4	1.45	2.3	8	50	2	●
NM-2BP-R0.75-M16		0.75	1.5	4	1.45	2.3	16	50	2	●
NM-2BP-R1.0-M06		1	2	4	1.95	3	6	50	2	●
NM-2BP-R1.0-M08		1	2	4	1.95	3	8	50	2	●
NM-2BP-R1.0-M10		1	2	4	1.95	3	10	50	2	●
NM-2BP-R1.0-M12		1	2	4	1.95	3	12	50	2	●
NM-2BP-R1.0-M16		1	2	4	1.95	3	16	50	2	●
NM-2BP-R1.0-M20		1	2	4	1.95	3	20	60	2	●
NM-2BP-R1.5-M10		1.5	3	6	2.85	4.5	10	50	2	●
NM-2BP-R1.5-M20		1.5	3	6	2.85	4.5	20	60	2	●
NM-2BP-R2.0-M10		2	4	6	3.85	6	10	60	2	●
NM-2BP-R2.0-M16		2	4	6	3.85	6	16	60	2	●
NM-2BP-R2.0-M20		2	4	6	3.85	6	20	60	2	●
NM-2BP-R2.0-M25		2	4	6	3.85	6	25	60	2	●
NM-2BP-R2.5-M16		2.5	5	6	4.85	7.5	16	60	2	●
NM-2BP-R2.5-M25		2.5	5	6	4.85	7.5	25	70	2	●

- Ex stock ○ On demand
- * With internal cooling

Application field

P	M	K	N	S	H
			✓		

- ✓ Very suitable
- ✓ Suitable

System code > B278

Cutting data > B492

Nonstandard order > B541

End mill **General machining of Al and Al alloys**

AL-2E

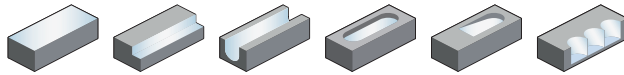

- Factory standard
- Centre cutting
- Helix angle 55°

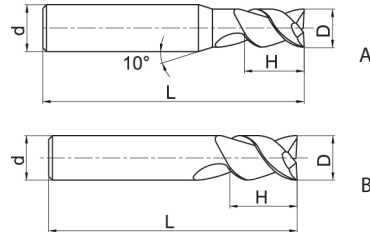

Article	*	Dimensions [mm]				Teeth	Geometry	Grade
		D	d (h6)	H	L			YK30F
AL-2E-D1.0		1	4	3	50	2	A	●
AL-2E-D1.5		1.5	4	4	50	2	A	●
AL-2E-D2.0		2	4	6	50	2	A	●
AL-2E-D2.5		2.5	4	7	50	2	A	●
AL-2E-D3.0		3	6	9	50	2	A	●
AL-2E-D4.0		4	6	12	50	2	A	●
AL-2E-D5.0		5	6	15	50	2	A	●
AL-2E-D6.0		6	6	18	60	2	B	●
AL-2E-D8.0		8	8	20	60	2	B	●
AL-2E-D10.0		10	10	30	75	2	B	●
AL-2E-D12.0		12	12	32	75	2	B	●
AL-2E-D16.0		16	16	45	100	2	B	●
AL-2E-D20.0		20	20	45	100	2	B	●

- Ex stock ○ On demand
- * With internal cooling

Application field					
P	M	K	N	S	H
			✓		

- ✓ Very suitable
- ✓ Suitable

A

Turning

B

Milling

C

Drilling

D

Technical Information

E

Index

A

End mill long cutting edge General machining of Al and Al alloys

AL-2EL

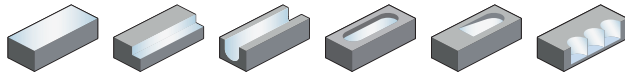

- Factory standard
- Centre cutting
- Helix angle 55°

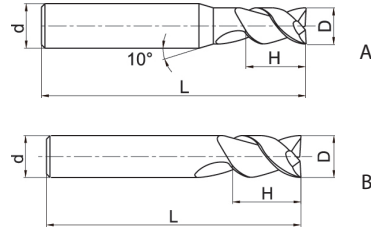

Turning

B

Milling

Article	*	Dimensions [mm]				Teeth	Geometry	Grade
		D	d (h6)	H	L			YK30F
AL-2EL-D3.0		3	6	12	60	2	A	●
AL-2EL-D4.0		4	6	16	60	2	A	●
AL-2EL-D5.0		5	6	20	60	2	A	●
AL-2EL-D6.0		6	6	25	75	2	B	●
AL-2EL-D8.0		8	8	32	75	2	B	●
AL-2EL-D10.0		10	10	45	100	2	B	●
AL-2EL-D12.0		12	12	45	100	2	B	●
AL-2EL-D16.0		16	16	65	150	2	B	●
AL-2EL-D20.0		20	20	75	150	2	B	●

● Ex stock ○ On demand

* With internal cooling

C

Drilling

Application field					
P	M	K	N	S	H
			✓		

- ✓ Very suitable
- ✓ Suitable

D

Technical Information

E

Index

System code > B278

Cutting data > B492

Nonstandard order > B541

End mill **General machining of Al and Al alloys**

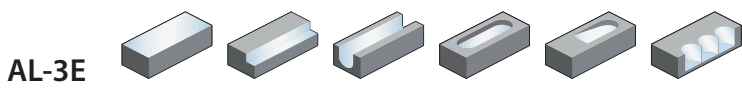

- Factory standard
- Centre cutting
- Helix angle 45°

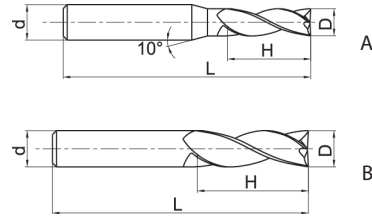

Article	*	Dimensions [mm]				Teeth	Geometry	Grade
		D	d (h6)	H	L			YK30F
AL-3E-D1.0		1	4	3	50	3	A	●
AL-3E-D1.5		1.5	4	4	50	3	A	●
AL-3E-D2.0		2	4	6	50	3	A	●
AL-3E-D2.5		2.5	4	7	50	3	A	●
AL-3E-D3.0		3	6	9	50	3	A	●
AL-3E-D4.0		4	6	12	50	3	A	●
AL-3E-D5.0		5	6	15	50	3	A	●
AL-3E-D6.0		6	6	18	60	3	B	●
AL-3E-D8.0		8	8	20	60	3	B	●
AL-3E-D10.0		10	10	30	75	3	B	●
AL-3E-D12.0		12	12	32	75	3	B	●
AL-3E-D16.0		16	16	45	100	3	B	●
AL-3E-D20.0		20	20	45	100	3	B	●

- Ex stock ○ On demand
- * With internal cooling

Application field					
P	M	K	N	S	H
			✓		

- ✓ Very suitable
- ✓ Suitable

A

Turning

B

Milling

C

Drilling

D

Technical Information

E

Index

A

End mill long cutting edge General machining of Al and Al alloys

AL-3EL

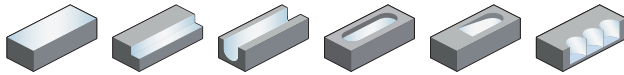

- Factory standard
- Centre cutting
- Helix angle 45°

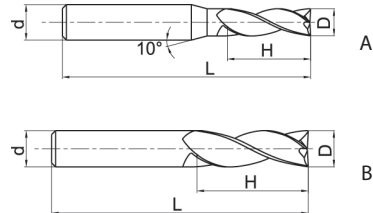

Turning

B

Milling

Article	*	Dimensions [mm]				Teeth	Geometry	Grade
		D	d (h6)	H	L			YK30F
AL-3EL-D3.0		3	6	12	60	3	A	●
AL-3EL-D4.0		4	6	16	60	3	A	●
AL-3EL-D5.0		5	6	20	60	3	A	●
AL-3EL-D6.0		6	6	25	75	3	B	●
AL-3EL-D8.0		8	8	32	75	3	B	●
AL-3EL-D10.0		10	10	45	100	3	B	●
AL-3EL-D12.0		12	12	45	100	3	B	●
AL-3EL-D16.0		16	16	65	150	3	B	●
AL-3EL-D20.0		20	20	75	150	3	B	●

● Ex stock ○ On demand

* With internal cooling

C

Drilling

Application field					
P	M	K	N	S	H
			✓		

- ✓ Very suitable
- ✓ Suitable

D

Technical Information

E

Index

System code > B278

Cutting data > B492

Nonstandard order > B541

End mill serrated teeth **General machining of Al and Al alloys**

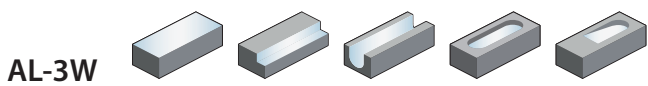

- Factory standard
- Centre cutting
- Helix angle 30°



Article	*	Dimensions [mm]				Teeth	Grade
		D	d (h6)	H	L		YK30F
AL-3W-D6.0		6	6	16	50	3	●
AL-3W-D8.0		8	8	20	60	3	●
AL-3W-D10.0		10	10	25	75	3	●
AL-3W-D12.0		12	12	30	75	3	●
AL-3W-D16.0		16	16	45	100	3	●
AL-3W-D18.0		18	18	45	100	3	○
AL-3W-D20.0		20	20	45	100	3	●

● Ex stock ○ On demand

* With internal cooling

Application field					
P	M	K	N	S	H
			✓		

✓ Very suitable

✓ Suitable

A

Turning

B

Milling

C

Drilling

D

Technical Information

E

Index

System code > B278

Cutting data > B492

Nonstandard order > B541



A

Ball nose cutter High performance machining of non-ferrous metals

5565R302NH

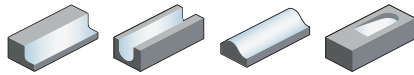

- Type of shank DIN 6535HA
- Centre cutting
- Helix angle 30°

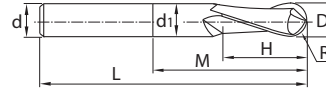

Turning

B

Article	*	Dimensions [mm]							Teeth	Grade
		D	R	d (h6)	d ₁	H	M	L		YK40F
5565R302NH-0300		3	1.5	6	2.8	6	9	57	2	●
5565R302NH-0400		4	2	6	3.7	8	12	57	2	●
5565R302NH-0500		5	2.5	6	4.6	10	15	57	2	●
5565R302NH-0600		6	3	6	5.5	12	20	57	2	●
5565R302NH-0800		8	4	8	7.4	16	26	63	2	●
5565R302NH-1000		10	5	10	9.2	20	31	72	2	●
5565R302NH-1200		12	6	12	11	24	37	83	2	●
5565R302NH-1600		16	8	16	15	32	43	92	2	●

● Ex stock ○ On demand

* With internal cooling

Milling

C

Application field					
P	M	K	N	S	H
			✓		

- ✓ Very suitable
- ✓ Suitable

Drilling

D

Technical Information

E

Index

System code > B278

Cutting data > B492

Nonstandard order > B541

Ball nose cutter long shank High performance machining of non-ferrous metals

5566R302NH

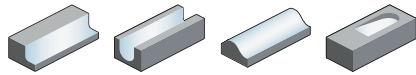

- Type of shank DIN 6535HA
- Centre cutting
- Helix angle 30°

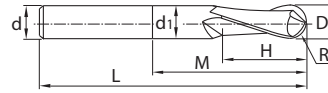

Article	*	Dimensions [mm]							Teeth	Grade YK40F
		D	R	d (h6)	d ₁	H	M	L		
5566R302NH-0300		3	1.5	6	2.8	6	9	75	2	●
5566R302NH-0400		4	2	6	3.7	8	12	75	2	●
5566R302NH-0500		5	2.5	6	4.6	10	15	80	2	●
5566R302NH-0600		6	3	6	5.5	12	20	80	2	●
5566R302NH-0800		8	4	8	7.4	16	26	90	2	●
5566R302NH-1000		10	5	10	9.2	20	31	100	2	●
5566R302NH-1200		12	6	12	11	24	37	120	2	●
5566R302NH-1600		16	8	16	15	32	43	140	2	●

● Ex stock ○ On demand

* With internal cooling

Application field					
P	M	K	N	S	H
			✓		

- ✓ Very suitable
- ✓ Suitable

A

Turning

B

Milling

C

Drilling

D

Technical Information

E

Index

System code > B278

Cutting data > B492

Nonstandard order > B541



A

Ball nose cutter General machining of Al and Al alloys

AL-2B

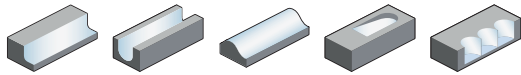

- Factory standard
- Centre cutting
- Helix angle 35°

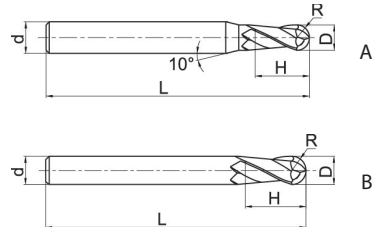

Turning

B

Milling

Article	*	Dimensions [mm]					Teeth	Geometry	Grade
		R	D	d (h6)	H	L			YK30F
AL-2B-R1.0		1	2	6	4	60	2	A	○
AL-2B-R1.5		1.5	3	6	6	60	2	A	○
AL-2B-R2.0		2	4	6	8	60	2	A	○
AL-2B-R2.5		2.5	5	6	10	60	2	A	○
AL-2B-R3.0		3	6	6	12	60	2	B	○
AL-2B-R4.0		4	8	8	16	75	2	B	○
AL-2B-R5.0		5	10	10	20	75	2	B	○
AL-2B-R6.0		6	12	12	24	75	2	B	○

● Ex stock ○ On demand

* With internal cooling

C

Drilling

Application field					
P	M	K	N	S	H
			✓		

- ✓ Very suitable
- ✓ Suitable

D

Technical Information

E

Index

System code > B278

Cutting data > B492

Nonstandard order > B541

Torus mill **General machining of Al and Al alloys**

AL-2R-AIR

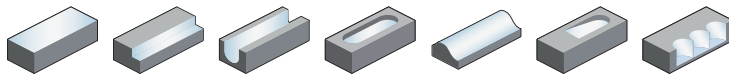

- Factory standard
- Centre cutting
- Helix angle 30°

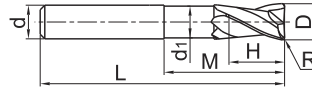

Article	*	Dimensions [mm]							Teeth	Grade YK40F
		R	D	d (h6)	d ₁	H	M	L		
AL-2R-D6.0R1.0-AIR		1	6	6	5.5	7	20	57	2	●
AL-2R-D8.0R1.0-AIR		1	8	8	7.4	9	26	63	2	●
AL-2R-D10.0R1.0-AIR		1	10	10	9.2	11	31	72	2	○
AL-2R-D10.0R2.0-AIR		2	10	10	9.2	11	31	72	2	○
AL-2R-D12.0R1.0-AIR		1	12	12	11	12	37	83	2	●
AL-2R-D12.0R2.0-AIR		2	12	12	11	12	37	83	2	○
AL-2R-D12.0R3.0-AIR		3	12	12	11	12	37	83	2	○
AL-2R-D16.0R1.0-AIR		1	16	16	15	16	43	92	2	○
AL-2R-D16.0R2.0-AIR		2	16	16	15	16	43	92	2	○
AL-2R-D16.0R3.0-AIR		3	16	16	15	16	43	92	2	○
AL-2R-D16.0R4.0-AIR		4	16	16	15	16	43	92	2	○
AL-2R-D20.0R1.0-AIR		1	20	20	19	20	53	104	2	●
AL-2R-D20.0R2.0-AIR		2	20	20	19	20	53	104	2	○
AL-2R-D20.0R3.0-AIR		3	20	20	19	20	53	104	2	○
AL-2R-D20.0R4.0-AIR		4	20	20	19	20	53	104	2	○
AL-2R-D20.0R5.0-AIR		5	20	20	19	20	53	104	2	●
AL-2R-D20.0R6.0-AIR		6	20	20	19	20	53	104	2	○

● Ex stock ○ On demand

* With internal cooling

Application field					
P	M	K	N	S	H
			✓		

- ✓ Very suitable
- ✓ Suitable

System code > B278

Cutting data > B492

Nonstandard order > B541



A

Turning

B

Milling

C

Drilling

D

Technical Information

E

Index

A

Torus mill long shank General machining of Al and Al alloys

AL-2RL-AIR

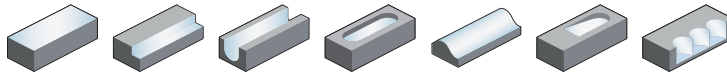

- Factory standard
- Centre cutting
- Helix angle 30°

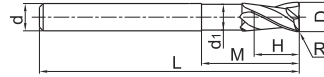

Turning

B

Article	*	Dimensions [mm]							Teeth	Grade
		R	D	d (h6)	d ₁	H	M	L		YK40F
AL-2RL-D6.0R1.0-AIR		1	6	6	5.5	7	43	80	2	●
AL-2RL-D8.0R1.0-AIR		1	8	8	7.4	9	53	90	2	●
AL-2RL-D10.0R1.0-AIR		1	10	10	9.2	11	59	100	2	●
AL-2RL-D10.0R2.0-AIR		2	10	10	9.2	11	59	100	2	●
AL-2RL-D12.0R1.0-AIR		1	12	12	11	12	74	120	2	●
AL-2RL-D12.0R2.0-AIR		2	12	12	11	12	74	120	2	●
AL-2RL-D12.0R3.0-AIR		3	12	12	11	12	74	120	2	●
AL-2RL-D16.0R1.0-AIR		1	16	16	15	16	84	140	2	●
AL-2RL-D16.0R2.0-AIR		2	16	16	15	16	84	140	2	●
AL-2RL-D16.0R3.0-AIR		3	16	16	15	16	84	140	2	●
AL-2RL-D16.0R4.0-AIR		4	16	16	15	16	84	140	2	●
AL-2RL-D20.0R1.0-AIR		1	20	20	19	20	89	140	2	○
AL-2RL-D20.0R2.0-AIR		2	20	20	19	20	89	140	2	●
AL-2RL-D20.0R3.0-AIR		3	20	20	19	20	89	140	2	●
AL-2RL-D20.0R4.0-AIR		4	20	20	19	20	89	140	2	●
AL-2RL-D20.0R5.0-AIR		5	20	20	19	20	89	140	2	○
AL-2RL-D20.0R6.0-AIR		6	20	20	19	20	89	140	2	○

● Ex stock ○ On demand

* With internal cooling

Milling

C

Drilling

D

Technical Information

Application field

P	M	K	N	S	H
			✓		

- ✓ Very suitable
- ✓ Suitable

E

Index

System code > B278

Cutting data > B492

Nonstandard order > B541

Torus mill

General machining of Al and Al alloys

AL-3R-AIR

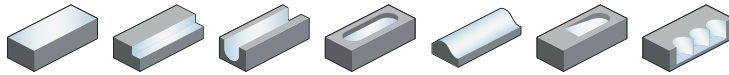

- Factory standard
- Centre cutting
- Helix angle 30°

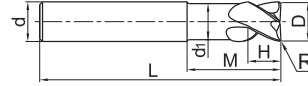

Article	*	Dimensions [mm]							Teeth	Grade
		R	D	d (h6)	d _i	H	M	L		
AL-3R-D12.0R1.0-AIR		1	12	12	11	12	37	83	3	●
AL-3R-D12.0R2.0-AIR		2	12	12	11	12	37	83	3	●
AL-3R-D12.0R3.0-AIR		3	12	12	11	12	37	83	3	●
AL-3R-D16.0R1.0-AIR		1	16	16	15	16	43	92	3	●
AL-3R-D16.0R2.0-AIR		2	16	16	15	16	43	92	3	●
AL-3R-D16.0R3.0-AIR		3	16	16	15	16	43	92	3	●
AL-3R-D16.0R4.0-AIR		4	16	16	15	16	43	92	3	●
AL-3R-D20.0R1.0-AIR		1	20	20	19	20	53	104	3	●
AL-3R-D20.0R2.0-AIR		2	20	20	19	20	53	104	3	○
AL-3R-D20.0R3.0-AIR		3	20	20	19	20	53	104	3	○
AL-3R-D20.0R4.0-AIR		4	20	20	19	20	53	104	3	○
AL-3R-D20.0R5.0-AIR		5	20	20	19	20	53	104	3	●
AL-3R-D20.0R6.0-AIR		6	20	20	19	20	53	104	3	○

● Ex stock ○ On demand

* With internal cooling

Application field					
P	M	K	N	S	H
			✓		

✓ Very suitable

✓ Suitable

A

Turning

B

Milling

C

Drilling

D

Technical Information

E

Index

System code > B278

Cutting data > B492

Nonstandard order > B541



A

Torus mill long shank General machining of Al and Al alloys

AL-3RL-AIR

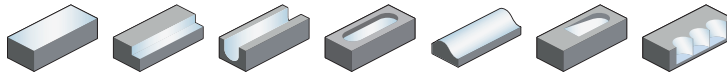

- Factory standard
- Centre cutting
- Helix angle 30°

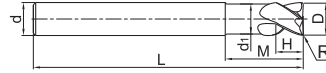

Turning

B

Article	*	Dimensions [mm]							Teeth	Grade
		R	D	d (h6)	d ₁	H	M	L		YK40F
AL-3RL-D12.0R1.0-AIR		1	12	12	11	12	74	120	3	●
AL-3RL-D12.0R2.0-AIR		2	12	12	11	12	74	120	3	●
AL-3RL-D12.0R3.0-AIR		3	12	12	11	12	74	120	3	●
AL-3RL-D16.0R1.0-AIR		1	16	16	15	16	84	140	3	●
AL-3RL-D16.0R2.0-AIR		2	16	16	15	16	84	140	3	○
AL-3RL-D16.0R3.0-AIR		3	16	16	15	16	84	140	3	●
AL-3RL-D16.0R4.0-AIR		4	16	16	15	16	84	140	3	●
AL-3RL-D20.0R1.0-AIR		1	20	20	19	20	89	140	3	●
AL-3RL-D20.0R2.0-AIR		2	20	20	19	20	89	140	3	○
AL-3RL-D20.0R3.0-AIR		3	20	20	19	20	89	140	3	○
AL-3RL-D20.0R4.0-AIR		4	20	20	19	20	89	140	3	○
AL-3RL-D20.0R5.0-AIR		5	20	20	19	20	89	140	3	○
AL-3RL-D20.0R6.0-AIR		6	20	20	19	20	89	140	3	○

Milling

C

- Ex stock ○ On demand
- * With internal cooling

Drilling

Application field

P	M	K	N	S	H
			✓		

- ✓ Very suitable
- ✓ Suitable

D

Technical Information

E

Index

System code > B278

Cutting data > B492

Nonstandard order > B541

End mill **General machining of Al and Al alloys**

ALG-2E

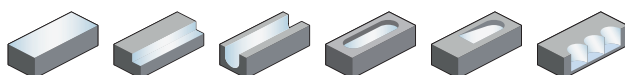

- Factory standard
- Centre cutting
- Helix angle 30°

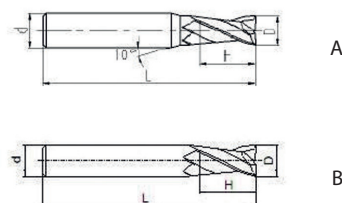

Article	*	Dimensions [mm]				Teeth	Geometry	Grade
		D	d (h6)	H	L			YK40F
ALG-2E-D1.0		1	4	3	50	2	A	●
ALG-2E-D1.5		1.5	4	4	50	2	A	○
ALG-2E-D2.0		2	4	6	50	2	A	●
ALG-2E-D2.5		2.5	4	8	50	2	A	○
ALG-2E-D3.0S		3	4	8	50	2	A	●
ALG-2E-D3.5S		3.5	4	10	50	2	A	○
ALG-2E-D4.0S		4	4	11	50	2	B	○
ALG-2E-D3.0		3	6	8	50	2	A	●
ALG-2E-D3.5		3.5	6	10	50	2	A	○
ALG-2E-D4.0		4	6	11	50	2	A	●
ALG-2E-D4.5		4.5	6	11	50	2	A	○
ALG-2E-D5.0		5	6	13	50	2	A	●
ALG-2E-D5.5		5.5	6	16	50	2	A	○
ALG-2E-D6.0		6	6	16	50	2	B	●
ALG-2E-D7.0		7	8	20	60	2	A	○
ALG-2E-D8.0		8	8	20	60	2	B	●
ALG-2E-D9.0		9	10	22	75	2	A	○
ALG-2E-D10.0		10	10	25	75	2	B	●
ALG-2E-D11.0		11	12	26	75	2	A	○
ALG-2E-D12.0		12	12	30	75	2	B	●
ALG-2E-D14.0		14	14	32	75	2	B	●
ALG-2E-D16.0		16	16	45	100	2	B	●
ALG-2E-D18.0		18	18	45	100	2	B	○
ALG-2E-D20.0		20	20	45	100	2	B	●

● Ex stock ○ On demand

* With internal cooling

Application field					
P	M	K	N	S	H
			✓		

- ✓ Very suitable
- ✓ Suitable

System code > B278

Cutting data > B492

Nonstandard order > B541



A

Turning

B

Milling

C

Drilling

D

Technical Information

E

Index

A

End mill General machining of Al and Al alloys

ALG-3E

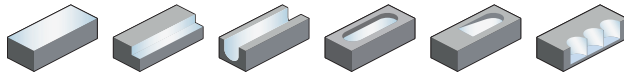

- Factory standard
- Centre cutting
- Helix angle 45°

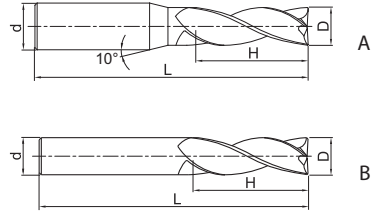

Turning

B

Milling

Article	*	Dimensions [mm]				Teeth	Geometry	Grade	
		D	d (h6)	H	L			KMD401	YK40F
ALG-3E-D1.0		1	4	3	50	3	A	○	●
ALG-3E-D1.5		1.5	4	4	50	3	A	○	●
ALG-3E-D2.0		2	4	6	50	3	A	○	●
ALG-3E-D2.5		2.5	4	8	50	3	A	○	○
ALG-3E-D3.0S		3	4	8	50	3	A	○	●
ALG-3E-D3.5S		3.5	4	10	50	3	A	○	○
ALG-3E-D4.0S		4	4	11	50	3	B	○	●
ALG-3E-D3.0		3	6	8	50	3	A	●	●
ALG-3E-D3.5		3.5	6	10	50	3	A	●	○
ALG-3E-D4.0		4	6	11	50	3	A	●	●
ALG-3E-D4.5		4.5	6	11	50	3	A	●	○
ALG-3E-D5.0		5	6	13	50	3	A	●	●
ALG-3E-D5.5		5.5	6	16	50	3	A	●	○
ALG-3E-D6.0		6	6	16	50	3	B	●	●
ALG-3E-D7.0		7	8	20	60	3	A	●	○
ALG-3E-D8.0		8	8	20	60	3	B	●	●
ALG-3E-D9.0		9	10	22	75	3	A	●	○
ALG-3E-D10.0		10	10	25	75	3	B	●	●
ALG-3E-D11.0		11	12	26	75	3	A	●	○
ALG-3E-D12.0		12	12	30	75	3	B	●	●
ALG-3E-D14.0		14	14	32	75	3	B	●	●
ALG-3E-D16.0		16	16	45	100	3	B	●	●
ALG-3E-D18.0		18	18	45	100	3	B	●	○
ALG-3E-D20.0		20	20	45	100	3	B	○	●

● Ex stock ○ On demand

* With internal cooling

C

Drilling

D

Technical Information

E

Index

Application field

P	M	K	N	S	H
			✓		

✓ Very suitable

✓ Suitable

System code > B278

Cutting data > B492

Nonstandard order > B541

End mill

General machining of Al and Al alloys

ALG-3E-W

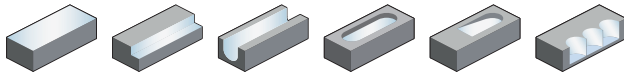

- Factory standard with weldon clamping surface
- Centre cutting
- Helix angle 45°

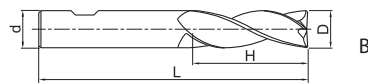
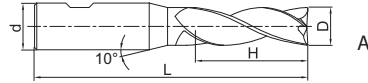

Article	*	Dimensions [mm]				Teeth	Geometry	Grade
		D	d (h6)	H	L			KMD401
ALG-3E-D3.0-W		3	6	8	50	3	A	●
ALG-3E-D3.5-W		3.5	6	10	50	3	A	●
ALG-3E-D4.0-W		4	6	11	50	3	A	●
ALG-3E-D4.5-W		4.5	6	11	50	3	A	●
ALG-3E-D5.0-W		5	6	13	50	3	A	●
ALG-3E-D5.5-W		5.5	6	16	50	3	A	●
ALG-3E-D6.0-W		6	6	16	50	3	B	●
ALG-3E-D7.0-W		7	8	20	60	3	A	●
ALG-3E-D8.0-W		8	8	20	60	3	B	●
ALG-3E-D9.0-W		9	10	22	75	3	A	●
ALG-3E-D10.0-W		10	10	25	75	3	B	●
ALG-3E-D11.0-W		11	12	26	75	3	A	●
ALG-3E-D12.0-W		12	12	30	75	3	B	●
ALG-3E-D14.0-W		14	14	32	75	3	B	●
ALG-3E-D16.0-W		16	16	45	100	3	B	●
ALG-3E-D18.0-W		18	18	45	100	3	B	●
ALG-3E-D20.0-W		20	20	45	100	3	B	●

● Ex stock ○ On demand

* With internal cooling

Application field					
P	M	K	N	S	H
			✓		

- ✓ Very suitable
- ✓ Suitable

System code > B278

Cutting data > B492

Nonstandard order > B541



A

End mill

High-performance machining of Al and Al alloys

ALP-3E

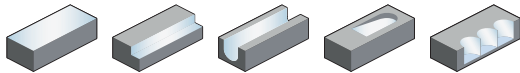

- Factory standard
- Centre cutting
- Helix angle 35°

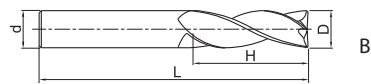
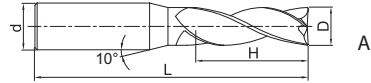

Turning

B

Milling

C

Drilling

D

Technical Information

E

Index

Article	*	Dimensions [mm]				Teeth	Geometry	Grade	
		D	d (h6)	H	L			KMD401	YK40F
ALP-3E-D1.0		1	4	3	50	3	A	○	○
ALP-3E-D1.5		1.5	4	4	50	3	A	○	●
ALP-3E-D2.0		2	4	6	50	3	A	○	●
ALP-3E-D2.5		2.5	4	8	50	3	A	○	○
ALP-3E-D3.0S		3	4	8	50	3	A	○	●
ALP-3E-D4.0S		4	4	11	50	3	B	○	●
ALP-3E-D3.0		3	6	8	50	3	A	●	●
ALP-3E-D4.0		4	6	11	50	3	A	●	●
ALP-3E-D4.5		4.5	6	11	50	3	A	●	○
ALP-3E-D5.0		5	6	13	50	3	A	●	●
ALP-3E-D5.5		5.5	6	16	50	3	A	●	○
ALP-3E-D6.0		6	6	16	50	3	B	●	●
ALP-3E-D7.0		7	8	20	60	3	B	●	○
ALP-3E-D8.0		8	8	20	60	3	B	●	●
ALP-3E-D9.0		9	10	22	75	3	B	●	○
ALP-3E-D10.0		10	10	25	75	3	B	●	●
ALP-3E-D11.0		11	12	26	75	3	B	●	●
ALP-3E-D12.0		12	12	30	75	3	B	●	●
ALP-3E-D14.0		14	14	32	75	3	B	●	●
ALP-3E-D16.0		16	16	45	100	3	B	●	●
ALP-3E-D20.0		20	20	45	100	3	B	●	○

● Ex stock ○ On demand

* With internal cooling

Application field

P	M	K	N	S	H
			✓		

✓ Very suitable

✓ Suitable

System code > B278

Cutting data > B492

Nonstandard order > B541

End mill

High-performance machining of Al and Al alloys

ALP-3E-W

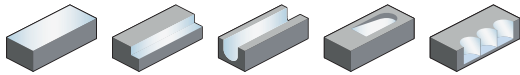

- Factory standard with weldon clamping surface
- Centre cutting
- Helix angle 35°

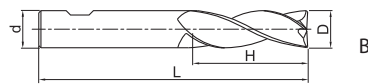
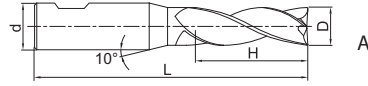

Article	*	Dimensions [mm]				Teeth	Geometry	Grade
		D	d (h6)	H	L			KMD401
ALP-3E-D3.0-W		3	6	8	50	3	A	●
ALP-3E-D4.0-W		4	6	11	50	3	A	●
ALP-3E-D4.5-W		4.5	6	11	50	3	A	●
ALP-3E-D5.0-W		5	6	13	50	3	A	●
ALP-3E-D5.5-W		5.5	6	16	50	3	A	●
ALP-3E-D6.0-W		6	6	16	50	3	B	●
ALP-3E-D7.0-W		7	8	20	60	3	B	●
ALP-3E-D8.0-W		8	8	20	60	3	B	●
ALP-3E-D9.0-W		9	10	22	75	3	B	●
ALP-3E-D10.0-W		10	10	25	75	3	B	●
ALP-3E-D11.0-W		11	12	26	75	3	B	●
ALP-3E-D12.0-W		12	12	30	75	3	B	●
ALP-3E-D14.0-W		14	14	32	75	3	B	●
ALP-3E-D16.0-W		16	16	45	100	3	B	●
ALP-3E-D20.0-W		20	20	45	100	3	B	●

● Ex stock ○ On demand

* With internal cooling

Application field					
P	M	K	N	S	H
			✓		

- ✓ Very suitable
- ✓ Suitable

System code > B278 Cutting data > B492 Nonstandard order > B541



A

Turning

B

Milling

C

Drilling

D

Technical Information

E

Index

A

End mill High-performance machining of Al and Al alloys

ALP-4E

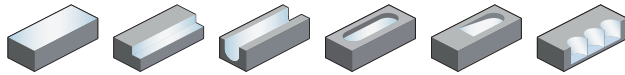

- Factory standard
- Centre cutting
- Helix angle 38°

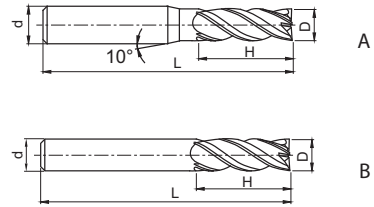

Turning

B

Milling

Article	*	Dimensions [mm]				Teeth	Geometry	Grade	
		D	d (h6)	H	L			KMD401	YK40F
ALP-4E-D3.0S	*	3	4	9	50	4	A	○	●
ALP-4E-D4.0S	*	4	4	11	50	4	B	○	●
ALP-4E-D3.0		3	6	9	50	4	A	●	●
ALP-4E-D4.0		4	6	11	50	4	A	●	●
ALP-4E-D5.0		5	6	13	50	4	A	●	●
ALP-4E-D6.0		6	6	16	50	4	B	●	●
ALP-4E-D8.0		8	8	20	60	4	B	●	●
ALP-4E-D10.0		10	10	25	75	4	B	●	●
ALP-4E-D12.0		12	12	30	75	4	B	●	●
ALP-4E-D16.0		16	16	45	100	4	B	●	●
ALP-4E-D18.0		18	18	45	100	4	B	●	○
ALP-4E-D20.0		20	20	45	100	4	B	●	●

● Ex stock ○ On demand

* With internal cooling

C

Drilling

D

Technical Information

Application field

P	M	K	N	S	H
			✓		

✓ Very suitable

✓ Suitable

E

Index

System code > B278

Cutting data > B492

Nonstandard order > B541

End mill

High-performance machining of Al and Al alloys

ALP-4E-W

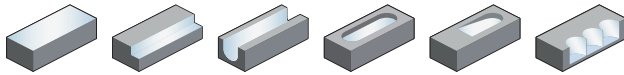

- Factory standard with weldon clamping surface
- Centre cutting
- Helix angle 38°

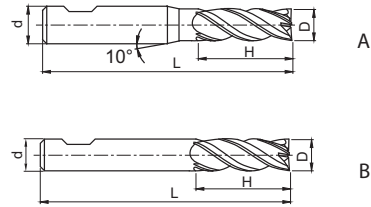

Article	*	Dimensions [mm]				Teeth	Geometry	Grade
		D	d (h6)	H	L			KMD401
ALP-4E-D3.0-W		3	6	9	50	4	A	●
ALP-4E-D4.0-W		4	6	11	50	4	A	●
ALP-4E-D5.0-W		5	6	13	50	4	A	●
ALP-4E-D6.0-W		6	6	16	50	4	B	●
ALP-4E-D8.0-W		8	8	20	60	4	B	●
ALP-4E-D10.0-W		10	10	25	75	4	B	●
ALP-4E-D12.0-W		12	12	30	75	4	B	●
ALP-4E-D16.0-W		16	16	45	100	4	B	●
ALP-4E-D18.0-W		18	18	45	100	4	B	●
ALP-4E-D20.0-W		20	20	45	100	4	B	●

● Ex stock ○ On demand

* With internal cooling

Application field					
P	M	K	N	S	H
			✓		

✓ Very suitable

✓ Suitable

A

Turning

B

Milling

C

Drilling

D

Technical Information

E

Index

System code > B278

Cutting data > B492

Nonstandard order > B541



A

Torus mill General machining of Al and Al alloys

ALG-2R

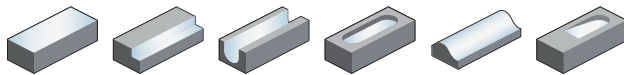

- Straight shank
- Centre cutting
- Helix angle 30°

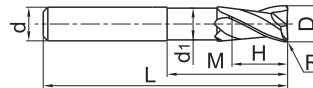

Turning

B

Article	*	Dimensions [mm]							Teeth	Grade	
		R	D	d (h6)	d ₁	H	M	L		KMD401	YK40F
ALG-2R-D6.0R0.3		0.3	6	6	5,7	8	16	75	2	●	●
ALG-2R-D6.0R0.5		0.5	6	6	5,7	8	16	75	2	●	●
ALG-2R-D6.0R1.0		1	6	6	5,7	8	16	75	2	●	●
ALG-2R-D8.0R0.3		0.3	8	8	7,4	10	20	75	2	●	●
ALG-2R-D8.0R0.5		0.5	8	8	7,4	10	20	75	2	●	●
ALG-2R-D8.0R1.0		1	8	8	7,4	10	20	75	2	●	●
ALG-2R-D10.0R0.5		0.5	10	10	9,4	12	35	100	2	●	●
ALG-2R-D10.0R1.0		1	10	10	9,4	12	35	100	2	●	●
ALG-2R-D10.0R1.6		1.6	10	10	9,4	12	35	100	2	●	●
ALG-2R-D10.0R2.5		2.5	10	10	9,4	12	35	100	2	●	●
ALG-2R-D12.0R0.5		0.5	12	12	11,4	15	35	100	2	●	●
ALG-2R-D12.0R1.0		1	12	12	11,4	15	35	100	2	●	●
ALG-2R-D12.0R1.6		1.6	12	12	11,4	15	35	100	2	●	●
ALG-2R-D12.0R2.5		2.5	12	12	11,4	15	35	100	2	●	●
ALG-2R-D12.0R3.2		3.2	12	12	11,4	15	35	100	2	●	●
ALG-2R-D12.0R4.0		4	12	12	11,4	15	35	100	2	●	●
ALG-2R-D16.0R1.0		1	16	16	15,4	15	45	125	2	●	●
ALG-2R-D16.0R1.6		1.6	16	16	15,4	15	45	125	2	●	●
ALG-2R-D16.0R2.5		2.5	16	16	15,4	15	45	125	2	●	●
ALG-2R-D16.0R3.2		3.2	16	16	15,4	15	45	125	2	●	●
ALG-2R-D16.0R4.0		4	16	16	15,4	15	45	125	2	●	●
ALG-2R-D16.0R6.3		6.3	16	16	15,4	15	45	125	2	○	○
ALG-2R-D20.0R1.0		1	20	20	18	20	50	125	2	●	●
ALG-2R-D20.0R1.6		1.6	20	20	18	20	50	125	2	●	●
ALG-2R-D20.0R2.5		2.5	20	20	18	20	50	125	2	●	●
ALG-2R-D20.0R3.2		3.2	20	20	18	20	50	125	2	●	●
ALG-2R-D20.0R4.0		4	20	20	18	20	50	125	2	●	●
ALG-2R-D20.0R6.3		6.3	20	20	18	20	50	125	2	○	○
ALG-2R-D25.0R6.3		6.3	25	25	23	25	75	150	2	○	○

● Ex stock ○ On demand

* With internal cooling

Milling

C

Drilling

D

Technical Information

E

Index

Application field

P	M	K	N	S	H
			✓		

✓ Very suitable

✓ Suitable

System code > B278

Cutting data > B492

Nonstandard order > B541

Torus mill

General machining of Al and Al alloys

ALG-2R-W

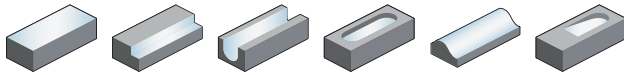

- Factory standard with weldon clamping surface
- Centre cutting
- Helix angle 30°

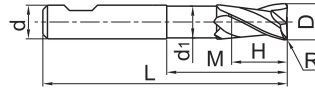

Article	*	Dimensions [mm]							Teeth	Grade
		R	D	d (h6)	d ₁	H	M	L		KMD401
ALG-2R-D6.0R0.3-W		0.3	6	6	5,7	8	16	75	2	●
ALG-2R-D6.0R0.5-W		0.5	6	6	5,7	8	16	75	2	●
ALG-2R-D6.0R1.0-W		1	6	6	5,7	8	16	75	2	●
ALG-2R-D8.0R0.3-W		0.3	8	8	7,4	10	20	75	2	●
ALG-2R-D8.0R0.5-W		0.5	8	8	7,4	10	20	75	2	●
ALG-2R-D8.0R1.0-W		1	8	8	7,4	10	20	75	2	●
ALG-2R-D10.0R0.5-W		0.5	10	10	9,4	12	35	100	2	●
ALG-2R-D10.0R1.0-W		1	10	10	9,4	12	35	100	2	●
ALG-2R-D10.0R1.6-W		1.6	10	10	9,4	12	35	100	2	●
ALG-2R-D10.0R2.5-W		2.5	10	10	9,4	12	35	100	2	●
ALG-2R-D12.0R0.5-W		0.5	12	12	11,4	15	35	100	2	●
ALG-2R-D12.0R1.0-W		1	12	12	11,4	15	35	100	2	●
ALG-2R-D12.0R1.6-W		1.6	12	12	11,4	15	35	100	2	●
ALG-2R-D12.0R2.5-W		2.5	12	12	11,4	15	35	100	2	●
ALG-2R-D12.0R3.2-W		3.2	12	12	11,4	15	35	100	2	●
ALG-2R-D12.0R4.0-W		4	12	12	11,4	15	35	100	2	●
ALG-2R-D16.0R1.0-W		1	16	16	15,4	15	45	125	2	●
ALG-2R-D16.0R1.6-W		1.6	16	16	15,4	15	45	125	2	●
ALG-2R-D16.0R2.5-W		2.5	16	16	15,4	15	45	125	2	●
ALG-2R-D16.0R3.2-W		3.2	16	16	15,4	15	45	125	2	●
ALG-2R-D16.0R4.0-W		4	16	16	15,4	15	45	125	2	●
ALG-2R-D16.0R6.3-W		6.3	16	16	15,4	15	45	125	2	○
ALG-2R-D20.0R1.0-W		1	20	20	18	20	50	125	2	●
ALG-2R-D20.0R1.6-W		1.6	20	20	18	20	50	125	2	●
ALG-2R-D20.0R2.5-W		2.5	20	20	18	20	50	125	2	●
ALG-2R-D20.0R3.2-W		3.2	20	20	18	20	50	125	2	●
ALG-2R-D20.0R4.0-W		4	20	20	18	20	50	125	2	●
ALG-2R-D20.0R6.3-W		6.3	20	20	18	20	50	125	2	○
ALG-2R-D25.0R6.3-W		6.3	25	25	23	25	75	150	2	○

● Ex stock ○ On demand

* With internal cooling

Application field

P	M	K	N	S	H
			✓		

✓ Very suitable

✓ Suitable

System code > B278

Cutting data > B492

Nonstandard order > B541



Notes

A

Turning

B

Milling

C

Drilling

D

Technical
Information

E

Index

Ball nose cutter **High-performance machining**

TM-4B

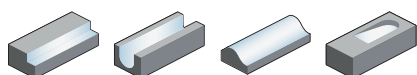

- Factory standard
- Centre cutting
- Helix angle 38°

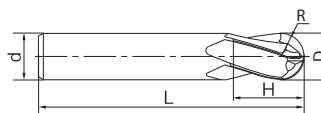

Article	*	Dimensions [mm]					Teeth	Grade
		R	D	d (h6)	H	L		KMS405
TM-4B-R3.0		3	6	6	9	50	4	●
TM-4B-R4.0		4	8	8	12	60	4	●
TM-4B-R5.0		5	10	10	15	75	4	●
TM-4B-R6.0		6	12	12	18	75	4	●
TM-4B-R8.0		8	16	16	24	85	4	●
TM-4B-R10.0		10	20	20	30	100	4	●

● Ex stock ○ On demand

* With internal cooling

Application field					
P	M	K	N	S	H
	✓			✓	

✓ Very suitable

✓ Suitable

A

Turning

B

Milling

C

Drilling

D

Technical Information

E

Index

System code > B278

Cutting data > B492

Nonstandard order > B541



A

Ball nose cutter High-performance machining

TM-4BL

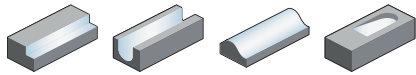

- Type of shank DIN 6535HA
- Centre cutting
- Helix angle 38°

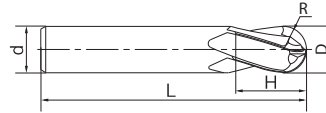

Turning

B

Article	*	Dimensions [mm]					Teeth	Grade
		R	D	d (h6)	H	L		KMS405
TM-4BL-R3.0		3	6	6	16	57	4	●
TM-4BL-R4.0		4	8	8	20	63	4	●
TM-4BL-R5.0		5	10	10	22	72	4	●
TM-4BL-R6.0		6	12	12	25	83	4	●
TM-4BL-R8.0		8	16	16	32	92	4	●
TM-4BL-R10.0		10	20	20	38	104	4	●

- Ex stock ○ On demand
- * With internal cooling

Milling

C

Application field						
P	M	K	N	S	H	
	✓			✓		✓ Very suitable ✓ Suitable

Drilling

D

Technical Information

E

Index

System code > B278

Cutting data > B492

Nonstandard order > B541

Ball nose cutter **High-performance machining**

TM-4BP

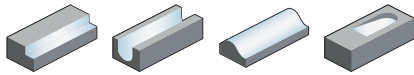

- Factory standard
- Centre cutting
- Helix angle 38°

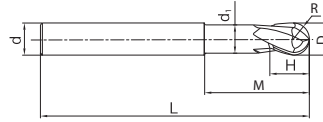
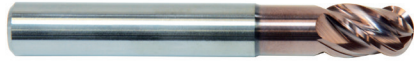

Article	*	Dimensions [mm]							Teeth	Grade
		R	D	d (h6)	d ₁	H	M	L		KMS405
TM-4BP-R3.0		3	6	6	5.5	9	18	60	4	●
TM-4BP-R4.0		4	8	8	7.4	12	24	75	4	●
TM-4BP-R5.0		5	10	10	9.4	15	30	75	4	●
TM-4BP-R6.0		6	12	12	11.4	18	35	90	4	●
TM-4BP-R8.0		8	16	16	15.4	24	40	90	4	●
TM-4BP-R10.0		10	20	20	19.4	35	50	110	4	●

- Ex stock ○ On demand
- * With internal cooling

Application field					
P	M	K	N	S	H
	✓			✓	

- ✓ Very suitable
- ✓ Suitable

A

Turning

B

Milling

C

Drilling

D

Technical Information

E

Index

System code > B278

Cutting data > B492

Nonstandard order > B541



A

Ball nose cutter High-performance machining

TM-5B

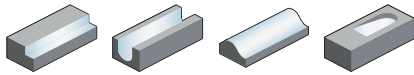

- Factory standard
- Helix angle 38°

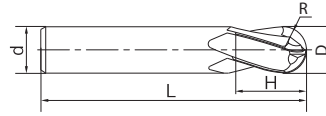
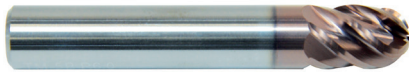

Turning

B

Article	*	Dimensions [mm]					Teeth	Grade
		R	D	d (h6)	H	L		KMS405
TM-5B-R3.0		3	6	6	9	50	5	●
TM-5B-R4.0		4	8	8	12	60	5	●
TM-5B-R5.0		5	10	10	15	75	5	●
TM-5B-R6.0		6	12	12	18	75	5	●
TM-5B-R8.0		8	16	16	24	85	5	●
TM-5B-R10.0		10	20	20	35	100	5	●

● Ex stock ○ On demand

* With internal cooling

Milling

C

Application field

P	M	K	N	S	H
	✓			✓	

✓ Very suitable

✓ Suitable

Drilling

D

Technical Information

E

Index

System code > B278

Cutting data > B492

Nonstandard order > B541

Ball nose cutter **High-performance machining**

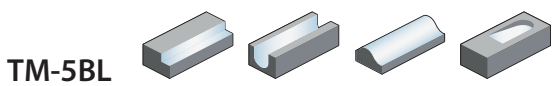

- Type of shank DIN 6535HA
- Helix angle 38°

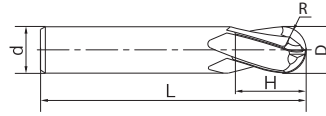

Article	*	Dimensions [mm]					Teeth	Grade
		R	D	d (h6)	H	L		KMS405
TM-5BL-R3.0		3	6	6	16	57	5	●
TM-5BL-R4.0		4	8	8	20	63	5	●
TM-5BL-R5.0		5	10	10	22	72	5	●
TM-5BL-R6.0		6	12	12	25	83	5	●
TM-5BL-R8.0		8	16	16	32	92	5	●
TM-5BL-R10.0		10	20	20	38	104	5	●

● Ex stock ○ On demand

* With internal cooling

Application field					
P	M	K	N	S	H
	✓			✓	

✓ Very suitable
 ✓ Suitable

A

Turning

B

Milling

C

Drilling

D

Technical Information

E

Index

System code > B278

Cutting data > B492

Nonstandard order > B541



A

Ball nose cutter High-performance machining

TM-5BP

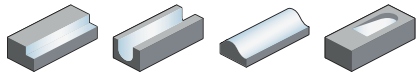

- Factory standard
- Helix angle 38°

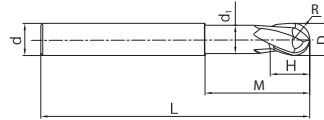
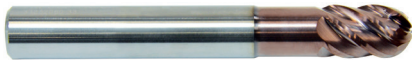

Turning

B

Article	*	Dimensions [mm]							Teeth	Grade
		R	D	d (h6)	d ₁	H	M	L		KMS405
TM-5BP-R3.0		3	6	6	5.5	9	18	60	5	●
TM-5BP-R4.0		4	8	8	7.4	12	24	75	5	●
TM-5BP-R5.0		5	10	10	9.4	15	30	75	5	●
TM-5BP-R6.0		6	12	12	11.4	18	35	90	5	●
TM-5BP-R8.0		8	16	16	15.4	24	40	90	5	●
TM-5BP-R10.0		10	20	20	19.4	35	50	110	5	●

● Ex stock ○ On demand

* With internal cooling

Milling

C

Application field

P	M	K	N	S	H
	✓			✓	

✓ Very suitable

✓ Suitable

Drilling

D

Technical Information

E

Index

System code > B278

Cutting data > B492

Nonstandard order > B541

Torus mill **High-performance machining**

TM-4R

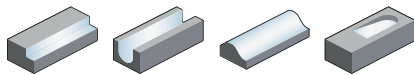

- Factory standard
- Centre cutting
- Helix angle 38°

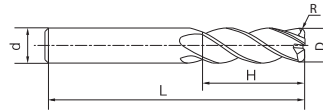

Article	*	Dimensions [mm]					Teeth	Grade
		R	D	d (h6)	H	L		KMS405
TM-4R-D6R0.5		0.5	6	6	16	50	4	●
TM-4R-D6R0.3		0.3	6	6	16	50	4	●
TM-4R-D6R1.0		1	6	6	16	50	4	●
TM-4R-D6R 0.75		0.75	6	6	16	50	4	○
TM-4R-D8R0.5		0.5	8	8	20	60	4	●
TM-4R-D8R0.3		0.3	8	8	20	60	4	●
TM-4R-D8R1.0		1	8	8	20	60	4	●
TM-4R-D8R0.75		0.75	8	8	20	60	4	○
TM-4R-D10R0.75		0.75	10	10	25	75	4	○
TM-4R-D10R1.6		1.6	10	10	25	75	4	●
TM-4R-D10R2.0		2	10	10	25	75	4	●
TM-4R-D10R0.5		0.5	10	10	25	75	4	●
TM-4R-D10R2.5		2.5	10	10	25	75	4	○
TM-4R-D10R1.0		1	10	10	25	75	4	●
TM-4R-D10R3.0		3	10	10	25	75	4	●
TM-4R-D10R1.25		1.25	10	10	25	75	4	○
TM-4R-D10R1.5		1.5	10	10	25	75	4	●
TM-4R-D12R1.5		1.5	12	12	30	75	4	●
TM-4R-D12R0.5		0.5	12	12	30	75	4	●
TM-4R-D12R1.0		1	12	12	30	75	4	●
TM-4R-D12R4.0		4	12	12	30	75	4	●
TM-4R-D12R1.6		1.6	12	12	30	75	4	●
TM-4R-D12R2.5		2.5	12	12	30	75	4	●
TM-4R-D12R1.25		1.25	12	12	30	75	4	○
TM-4R-D12R0.75		0.75	12	12	30	75	4	○
TM-4R-D12R3.0		3	12	12	30	75	4	●
TM-4R-D12R3.2		3.2	12	12	30	75	4	●
TM-4R-D12R2.0		2	12	12	30	75	4	●
TM-4R-D16R1.25		1.25	16	16	35	90	4	●
TM-4R-D16R4.0		4	16	16	35	90	4	●
TM-4R-D16R1.0		1	16	16	35	90	4	●
TM-4R-D16R3.0		3	16	16	35	90	4	●
TM-4R-D16R2.0		2	16	16	35	90	4	●
TM-4R-D16R6.3		6.3	16	16	35	90	4	○
TM-4R-D16R5.0		5	16	16	35	90	4	●
TM-4R-D16R1.5		1.5	16	16	35	90	4	●
TM-4R-D16R2.5		2.5	16	16	35	90	4	●

● Ex stock ○ On demand

* With internal cooling

Application field					
P	M	K	N	S	H
	✓			✓	

✓ Very suitable

✓ Suitable

System code > B278 Cutting data > B492 Nonstandard order > B541



A

Turning

B

Milling

C

Drilling

D

Technical Information

E

Index

Torus mill

High-performance machining

TM-4R

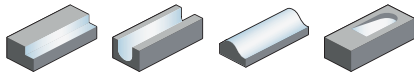

- Factory standard
- Centre cutting
- Helix angle 38°

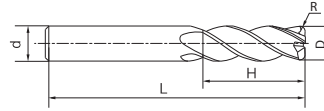
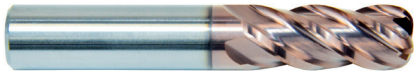

Article	*	Dimensions [mm]					Teeth	Grade
		R	D	d (h6)	H	L		KMS405
TM-4R-D16R1.6		1.6	16	16	35	90	4	●
TM-4R-D16R3.2		3.2	16	16	35	90	4	●
TM-4R-D20R1.5		1.5	20	20	45	100	4	●
TM-4R-D20R2.0		2	20	20	45	100	4	●
TM-4R-D20R2.5		2.5	20	20	45	100	4	●
TM-4R-D20R1.0		1	20	20	45	100	4	●
TM-4R-D20R4.0		4	20	20	45	100	4	●
TM-4R-D20R1.6		1.6	20	20	45	100	4	●
TM-4R-D20R5.0		5	20	20	45	100	4	●
TM-4R-D20R3.0		3	20	20	45	100	4	●
TM-4R-D20R3.2		3.2	20	20	45	100	4	●
TM-4R-D20R6.3		6.3	20	20	45	100	4	●
TM-4R-D20R1.25		1.25	21	20	45	100	4	●
TM-4R-D25R1.0		1	25	25	50	110	4	●
TM-4R-D25R3.0		3	25	25	50	110	4	●
TM-4R-D25R2.0		2	25	25	50	110	4	●
TM-4R-D25R2.5		2.5	25	25	50	110	4	○
TM-4R-D25R4.0		4	25	25	50	110	4	●
TM-4R-D25R3.2		3.2	25	25	50	110	4	●
TM-4R-D25R1.5		1.5	25	25	50	110	4	●
TM-4R-D25R5.0		5	25	25	50	110	4	●
TM-4R-D25R6.3		6.3	25	25	50	110	4	●
TM-4R-D25R1.6		1.6	25	25	50	110	4	●
TM-4R-D25R1.25		1.25	25	25	50	110	4	○

● Ex stock ○ On demand

* With internal cooling

Application field					
P	M	K	N	S	H
	✓			✓	

✓ Very suitable

✓ Suitable

System code > B278

Cutting data > B492

Nonstandard order > B541

A

Turning

B

Milling

C

Drilling

D

Technical Information

E

Index

Torus mill **High-performance machining**

TM-4RP

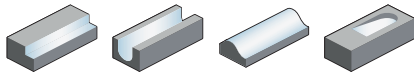

- Factory standard
- Centre cutting
- Helix angle 38°

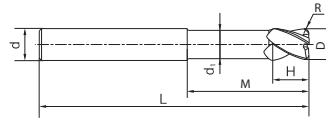

Article	*	Dimensions [mm]							Teeth	Grade
		R	D	d (h6)	d ₁	H	M	L		
TM-4RP-D8R0.75		0.75	8	8	7.4	16	25	75	4	○
TM-4RP-D8R1.0		1	8	8	7.4	16	25	75	4	●
TM-4RP-D8R0.3		0.3	8	8	7.4	16	25	75	4	●
TM-4RP-D8R0.5		0.5	8	8	7.4	16	25	75	4	●
TM-4RP-D10R2.0		2	10	10	9.4	20	32	75	4	●
TM-4RP-D10R1.6		1.6	10	10	9.4	20	32	75	4	●
TM-4RP-D10R1.5		1.5	10	10	9.4	20	32	75	4	●
TM-4RP-D10R1.25		1.25	10	10	9.4	20	32	75	4	●
TM-4RP-D10R3.0		3	10	10	9.4	20	32	75	4	●
TM-4RP-D10R0.5		0.5	10	10	9.4	20	32	75	4	●
TM-4RP-D10R0.75		0.75	10	10	9.4	20	32	75	4	○
TM-4RP-D10R2.5		2.5	10	10	9.4	20	32	75	4	○
TM-4RP-D10R1.0		1	10	10	9.4	20	32	75	4	●
TM-4RP-D12R1.25		1.25	12	12	11.4	24	40	90	4	●
TM-4RP-D12R1.0		1	12	12	11.4	24	40	90	4	●
TM-4RP-D12R2.0		2	12	12	11.4	24	40	90	4	●
TM-4RP-D12R0.5		0.5	12	12	11.4	24	40	90	4	●
TM-4RP-D12R3.0		3	12	12	11.4	24	40	90	4	●
TM-4RP-D12R4.0		4	12	12	11.4	24	40	90	4	●
TM-4RP-D12R3.2		3.2	12	12	11.4	24	40	90	4	●
TM-4RP-D12R1.5		1.5	12	12	11.4	24	40	90	4	●
TM-4RP-D12R2.5		2.5	12	12	11.4	24	40	90	4	○
TM-4RP-D12R0.75		0.75	12	12	11.4	24	40	90	4	○
TM-4RP-D12R1.6		1.6	12	12	11.4	24	40	90	4	●
TM-4RP-D16R6.3		6.3	16	16	15	32	50	100	4	○
TM-4RP-D16R4.0		4	16	16	15	32	50	100	4	●
TM-4RP-D16R5.0		5	16	16	15	32	50	100	4	●
TM-4RP-D16R3.2		3.2	16	16	15	32	50	100	4	●
TM-4RP-D16R1.25		1.25	16	16	15	32	50	100	4	●
TM-4RP-D16R2.5		2.5	16	16	15	32	50	100	4	○
TM-4RP-D16R1.0		1	16	16	15	32	50	100	4	●
TM-4RP-D16R3.0		3	16	16	14	32	50	100	4	●
TM-4RP-D16R1.6		1.6	16	16	15	32	50	100	4	●
TM-4RP-D16R1.5		1.5	16	16	15	32	50	100	4	●
TM-4RP-D16R2.0		2	16	16	15	32	50	100	4	●
TM-4RP-D20R1.6		1.6	20	20	19	35	60	110	4	●
TM-4RP-D20R4.0		4	20	20	19	35	60	110	4	●

● Ex stock ○ On demand

* With internal cooling

Application field					
P	M	K	N	S	H
	✓			✓	

✓ Very suitable

✓ Suitable

System code > B278 Cutting data > B492 Nonstandard order > B541



A

Turning

B

Milling

C

Drilling

D

Technical Information

E

Index

A

Torus mill High-performance machining

TM-4RP

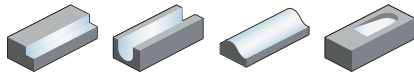

- Factory standard
- Centre cutting
- Helix angle 38°

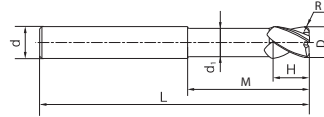

Turning

B

Article	*	Dimensions [mm]							Teeth	Grade KMS405
		R	D	d (h6)	d ₁	H	M	L		
TM-4RP-D20R1.0		1	20	20	19	35	60	110	4	●
TM-4RP-D20R1.5		1.5	20	20	19	35	60	110	4	●
TM-4RP-D20R1.25		1.25	20	20	19	35	60	110	4	●
TM-4RP-D20R2.5		2.5	20	20	19	35	60	110	4	○
TM-4RP-D20R2.0		2	20	20	19	35	60	110	4	●
TM-4RP-D20R3.0		3	20	20	19	35	60	110	4	●
TM-4RP-D20R5.0		5	20	20	19	35	60	110	4	●
TM-4RP-D20R6.3		6.3	20	20	19	35	60	110	4	●
TM-4RP-D20R3.2		3.2	20	20	19	35	60	110	4	●
TM-4RP-D25R3.0		3	25	25	24	45	75	150	4	●
TM-4RP-D25R6.3		6.3	25	25	24	45	75	150	4	●
TM-4RP-D25R2.5		2.5	25	25	24	45	75	150	4	●
TM-4RP-D25R4.0		4	25	25	24	45	75	150	4	●
TM-4RP-D25R3.2		3.2	25	25	24	45	75	150	4	●
TM-4RP-D25R1.5		1.5	25	25	24	45	75	150	4	●
TM-4RP-D25R2.0		2	25	25	24	45	75	150	4	●
TM-4RP-D25R1.25		1.25	25	25	24	45	75	150	4	○
TM-4RP-D25R5.0		5	25	25	24	45	75	150	4	●
TM-4RP-D25R1.0		1	25	25	24	45	75	150	4	●
TM-4RP-D25R1.6		1.6	25	25	24	45	75	150	4	●

● Ex stock ○ On demand

* With internal cooling

Milling

C

Drilling

D

Technical Information

Application field

P	M	K	N	S	H
	✓			✓	

✓ Very suitable

✓ Suitable

E

Index

System code > B278

Cutting data > B492

Nonstandard order > B541

Torus mill **High-performance machining**

TM-5R

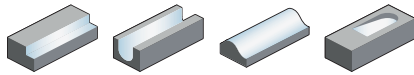

- Factory standard
- Helix angle 42°

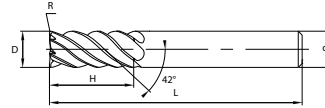

Article	*	Dimensions [mm]					Teeth	Grade KMS405
		R	D	d (h6)	H	L		
TM-5R-D6R1.0		1	6	6	16	50	5	●
TM-5R-D6R0.5		0.5	6	6	16	50	5	●
TM-5R-D6R0.3		0.3	6	6	16	50	5	●
TM-5R-D6R0.75		0.75	6	6	16	50	5	○
TM-5R-D8R0.5		0.5	8	8	20	60	5	●
TM-5R-D8R0.3		0.3	8	8	20	60	5	●
TM-5R-D8R0.75		0.75	8	8	20	60	5	○
TM-5R-D8R1.0		1	8	8	20	60	5	●
TM-5R-D10R3.0		3	10	10	25	75	5	●
TM-5R-D10R1.6		1.6	10	10	25	75	5	●
TM-5R-D10R2.5		2.5	10	10	25	75	5	○
TM-5R-D10R1.5		1.5	10	10	25	75	5	●
TM-5R-D10R2.0		2	10	10	25	75	5	●
TM-5R-D10R0.75		0.75	10	10	25	75	5	○
TM-5R-D10R1.0		1	10	10	25	75	5	●
TM-5R-D10R1.25		1.25	10	10	25	75	5	○
TM-5R-D10R0.5		0.5	10	10	25	75	5	●

● Ex stock ○ On demand

* With internal cooling

Application field					
P	M	K	N	S	H
	✓			✓	

✓ Very suitable

✓ Suitable

System code > B278

Cutting data > B492

Nonstandard order > B541



Solid carbide milling TM series

A

Torus mill High-performance machining

TM-7R

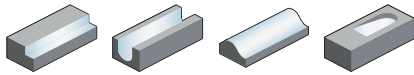

- Factory standard
- Helix angle 41°

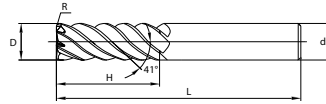

Turning

B

Article	*	Dimensions [mm]					Teeth	Grade
		R	D	d (h6)	H	L		KMS405
TM-7R-D12R2.0		2	12	12	30	75	7	●
TM-7R-D12R1.5		1.5	12	12	30	75	7	●
TM-7R-D12R1.0		1	12	12	30	75	7	●
TM-7R-D12R3.2		3.2	12	12	30	75	7	●
TM-7R-D12R1.6		1.6	12	12	30	75	7	●
TM-7R-D12R3.0		3	12	12	30	75	7	●
TM-7R-D12R0.75		0.75	12	12	30	75	7	○
TM-7R-D12R2.5		2.5	12	12	30	75	7	●
TM-7R-D12R4.0		4	12	12	30	75	7	●
TM-7R-D12R0.5		0.5	12	12	30	75	7	●
TM-7R-D12R1.25		1.25	12	12	30	75	7	○
TM-7R-D16R1.25		1.25	16	16	35	90	7	○
TM-7R-D16R5.0		5	16	16	35	90	7	●
TM-7R-D16R6.3		6.3	16	16	35	90	7	○
TM-7R-D16R1.0		1	16	16	35	90	7	●
TM-7R-D16R3.0		3	16	16	35	90	7	●
TM-7R-D16R2.0		2	16	16	35	90	7	●
TM-7R-D16R2.5		2.5	16	16	35	90	7	●
TM-7R-D16R3.2		3.2	16	16	35	90	7	●
TM-7R-D16R1.5		1.5	16	16	35	90	7	●
TM-7R-D16R1.6		1.6	16	16	35	90	7	●
TM-7R-D16R4.0		4	16	16	35	90	7	●
TM-7R-D20R4.0		4	20	20	45	100	7	●
TM-7R-D20R6.3		6.3	20	20	45	100	7	●
TM-7R-D20R1.5		1.5	20	20	45	100	7	●
TM-7R-D20R3.0		3	20	20	45	100	7	●
TM-7R-D20R5.0		5	20	20	45	100	7	●
TM-7R-D20R2.0		2	20	20	45	100	7	●
TM-7R-D20R1.6		1.6	20	20	45	100	7	●
TM-7R-D20R3.2		3.2	20	20	45	100	7	●
TM-7R-D20R2.5		2.5	20	20	45	100	7	●
TM-7R-D20R1.0		1	20	20	45	100	7	●
TM-7R-D20R1.25		1.25	21	20	45	100	7	○

Milling

C

Drilling

D

Technical Information

- Ex stock ○ On demand
- * With internal cooling

E

Index

Application field

P	M	K	N	S	H
	✓			✓	

- ✓ Very suitable
- ✓ Suitable

System code > B278

Cutting data > B492

Nonstandard order > B541

Torus mill **High-performance machining**

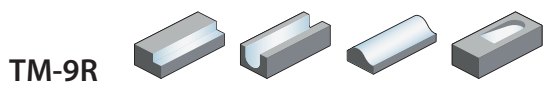

- Factory standard
- Helix angle 38°

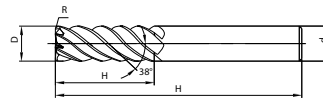

Article	*	Dimensions [mm]					Teeth	Grade
		R	D	d (h6)	H	L		KMS405
TM-9R-D25R2.0		2	25	25	50	110	9	●
TM-9R-D25R3.2		3.2	25	25	50	110	9	●
TM-9R-D25R1.6		1.6	25	25	50	110	9	●
TM-9R-D25R5.0		5	25	25	50	110	9	●
TM-9R-D25R1.25		1.25	25	25	50	110	9	○
TM-9R-D25R1.0		1	25	25	50	110	9	●
TM-9R-D25R1.5		1.5	25	25	50	110	9	●
TM-9R-D25R3.0		3	25	25	50	110	9	●
TM-9R-D25R6.3		6.3	25	25	50	110	9	●
TM-9R-D25R4.0		4	25	25	50	110	9	●
TM-9R-D25R2.5		2.5	25	25	50	110	9	○

- Ex stock ○ On demand
- * With internal cooling

Application field					
P	M	K	N	S	H
	✓			✓	

- ✓ Very suitable
- ✓ Suitable

A

Torus mill High-performance machining

TM-5RP

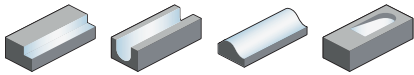

- Factory standard
- Helix angle 42°

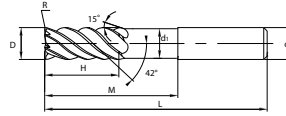
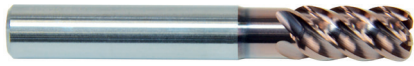

Turning

B

Article	*	Dimensions [mm]							Teeth	Grade
		R	D	d (h6)	d ₁	H	M	L		
TM-5RP-D8R0.5		0.5	8	8	7.4	16	25	75	5	●
TM-5RP-D8R1.0		1	8	8	7.4	16	25	75	5	●
TM-5RP-D8R0.3		0.3	8	8	7.4	16	25	75	5	●
TM-5RP-D8R0.75		0.75	8	8	7.4	16	25	75	5	○
TM-5RP-D10R1.6		1.6	10	10	9.4	20	32	75	5	●
TM-5RP-D10R1.5		1.5	10	10	9.4	20	32	75	5	●
TM-5RP-D10R3.0		3	10	10	9.4	20	32	75	5	●
TM-5RP-D10R0.5		0.5	10	10	9.4	20	32	75	5	●
TM-5RP-D10R1.25		1.25	10	10	9.4	20	32	75	5	○
TM-5RP-D10R2.0		2	10	10	9.4	20	32	75	5	●
TM-5RP-D10R1.0		1	10	10	9.4	20	32	75	5	●
TM-5RP-D10R0.75		0.75	10	10	9.4	20	32	75	5	○
TM-5RP-D10R2.5		2.5	10	10	9.4	20	32	75	5	●

Milling

C

- Ex stock ○ On demand
- * With internal cooling

Drilling

Application field						
P	M	K	N	S	H	
	✓			✓		✓ Very suitable
						✓ Suitable

D

Technical Information

E

Index

System code > B278

Cutting data > B492

Nonstandard order > B541

Torus mill **High-performance machining**

TM-7RP

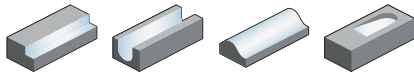

- Factory standard
- Helix angle 41°

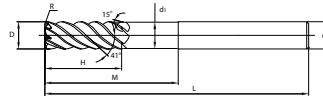

Article	*	Dimensions [mm]							Teeth	Grade
		R	D	d (h6)	d ₁	H	M	L		
TM-7RP-D12R1.6		1.6	12	12	11.4	24	40	90	7	●
TM-7RP-D12R1.5		1.5	12	12	11.4	24	40	90	7	●
TM-7RP-D12R2.0		2	12	12	11.4	24	40	90	7	●
TM-7RP-D12R2.5		2.5	12	12	11.4	24	40	90	7	●
TM-7RP-D12R4.0		4	12	12	11.4	24	40	90	7	●
TM-7RP-D12R0.5		0.5	12	12	11.4	24	40	90	7	●
TM-7RP-D12R1.0		1	12	12	11.4	24	40	90	7	●
TM-7RP-D12R3.0		3	12	12	11.4	24	40	90	7	●
TM-7RP-D12R0.75		0.75	12	12	11.4	24	40	90	7	○
TM-7RP-D12R3.2		3.2	12	12	11.4	24	40	90	7	●
TM-7RP-D12R1.25		1.25	12	12	11.4	24	40	90	7	○
TM-7RP-D16R2.0		2	16	16	15	32	50	100	7	●
TM-7RP-D16R3.2		3.2	16	16	15	32	50	100	7	●
TM-7RP-D16R1.5		1.5	16	16	15	32	50	100	7	●
TM-7RP-D16R1.6		1.6	16	16	15	32	50	100	7	●
TM-7RP-D16R4.0		4	16	16	15	32	50	100	7	●
TM-7RP-D16R3.0		3	16	16	15	32	50	100	7	●
TM-7RP-D16R1.0		1	16	16	15	32	50	100	7	●
TM-7RP-D16R5.0		5	16	16	15	32	50	100	7	●
TM-7RP-D16R6.3		6.3	16	16	15	32	50	100	7	○
TM-7RP-D16R1.25		1.25	16	16	15	32	50	100	7	○
TM-7RP-D16R2.5		2.5	16	16	15	32	50	100	7	●
TM-7RP-D20R3.0		3	20	20	19	35	60	110	7	●
TM-7RP-D20R1.5		1.5	20	20	19	35	60	110	7	●
TM-7RP-D20R6.3		6.3	20	20	19	35	60	110	7	●
TM-7RP-D20R2.5		2.5	20	20	19	35	60	110	7	●
TM-7RP-D20R5.0		5	20	20	19	35	60	110	7	●
TM-7RP-D20R1.25		1.25	20	20	19	35	60	110	7	○
TM-7RP-D20R1.0		1	20	20	19	35	60	110	7	●
TM-7RP-D20R3.2		3.2	20	20	19	35	60	110	7	●
TM-7RP-D20R1.6		1.6	20	20	19	35	60	110	7	●
TM-7RP-D20R2.0		2	20	20	19	35	60	110	7	●
TM-7RP-D20R4.0		4	20	20	19	35	60	110	7	●

● Ex stock ○ On demand

* With internal cooling

Application field					
P	M	K	N	S	H
	✓			✓	

✓ Very suitable

✓ Suitable

System code > B278

Cutting data > B492

Nonstandard order > B541



A

Turning

B

Milling

C

Drilling

D

Technical Information

E

Index

A

Torus mill High-performance machining

TM-9RP

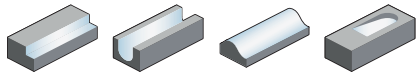

- Factory standard
- Helix angle 38°

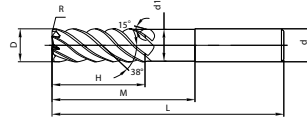

Turning

B

Article	*	Dimensions [mm]							Teeth	Grade
		R	D	d (h6)	d ₁	H	M	L		
TM-9RP-D25R3.0		3	25	25	24	45	75	150	9	●
TM-9RP-D25R3.2		3.2	25	25	24	45	75	150	9	●
TM-9RP-D25R6.3		6.3	25	25	24	45	75	150	9	●
TM-9RP-D25R1.0		1	25	25	24	45	75	150	9	●
TM-9RP-D25R1.6		1.6	25	25	24	45	75	150	9	●
TM-9RP-D25R1.5		1.5	25	25	24	45	75	150	9	●
TM-9RP-D25R2.0		2	25	25	24	45	75	150	9	●
TM-9RP-D25R4.0		4	25	25	24	45	75	150	9	●
TM-9RP-D25R5.0		5	25	25	24	45	75	150	9	●
TM-9RP-D25R1.25		1.25	25	25	24	45	75	150	9	○
TM-9RP-D25R2.5		2.5	25	25	24	45	75	150	9	●

Milling

C

- Ex stock ○ On demand
- * With internal cooling

Drilling

Application field						
P	M	K	N	S	H	
	✓			✓		✓ Very suitable ✓ Suitable

D

Technical Information

E

Index

System code > B278

Cutting data > B492

Nonstandard order > B541

End mill **HSC/HPC machining**

5501R38414GM

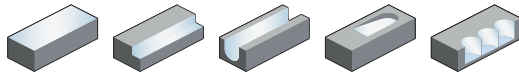

- Type of shank DIN 6535HA
- Centre cutting
- Helix angle 38°/41°

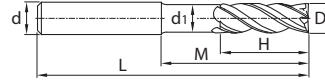

Article	*	Dimensions [mm]						Teeth	Grade
		D	d (h6)	d ₁	H	M	L		KMG405
5501R38414GM-0400		4	6	3.7	8	16	54	4	●
5501R38414GM-0500		5	6	4.7	9	17	54	4	●
5501R38414GM-0600		6	6	5.7	10	18	54	4	●
5501R38414GM-0800		8	8	7.7	12	22	58	4	●
5501R38414GM-1000		10	10	9.5	14	26	66	4	●
5501R38414GM-1200		12	12	11.5	16	28	73	4	●
5501R38414GM-1400		14	14	13.5	18	30	75	4	●
5501R38414GM-1600		16	16	15.5	22	34	82	4	●
5501R38414GM-1800		18	18	17.5	24	36	84	4	●
5501R38414GM-2000		20	20	19.5	26	42	92	4	●

- Ex stock ○ On demand
- * With internal cooling

Application field						
P	M	K	N	S	H	
✓	✓	✓				✓

- ✓ Very suitable
- ✓ Suitable

System code > B278

Cutting data > B492

Nonstandard order > B541



A

Turning

B

Milling

C

Drilling

D

Technical Information

E

Index

A

End mill long cutting edge HSC/HPC machining

5502R38414GM

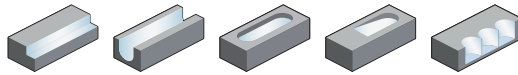

- Type of shank DIN 6535HA
- Centre cutting
- Helix angle 38°/41°

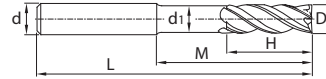

Turning

B

Article	*	Dimensions [mm]						Teeth	Grade	
		D	d (h6)	d ₁	H	M	L		KMG405	KMG406
5502R38414GM-0400		4	6	3.7	11	19	57	4	●	●
5502R38414GM-0500		5	6	4.7	13	21	57	4	●	●
5502R38414GM-0600		6	6	5.7	13	21	57	4	●	●
5502R38414GM-0800		8	8	7.7	19	27	63	4	●	●
5502R38414GM-1000		10	10	9.5	22	32	72	4	●	●
5502R38414GM-1200		12	12	11.5	26	38	83	4	●	●
5502R38414GM-1400		14	14	13.5	26	38	83	4	●	●
5502R38414GM-1600		16	16	15.5	32	44	92	4	●	●
5502R38414GM-1800		18	18	17.5	32	44	92	4	●	●
5502R38414GM-2000		20	20	19.5	38	54	104	4	●	●

- Ex stock ○ On demand
- * With internal cooling

Milling

C

Application field

P	M	K	N	S	H
✓	✓	✓			✓

- ✓ Very suitable
- ✓ Suitable

Drilling

D

Technical Information

E

Index

System code > B278

Cutting data > B492

Nonstandard order > B541

End mill **HSC/HPC machining**

5601R38414GM

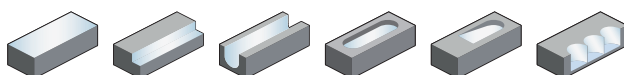

- Type of shank: DIN 6535HB
- Centre cutting
- Helix angle 38°/41°

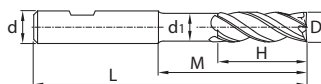

Article	*	Dimensions [mm]						Teeth	Grade
		D	d (h6)	d ₁	H	M	L		KMG405
5601R38414GM-0400		4	6	3.7	8	16	54	4	●
5601R38414GM-0500		5	6	4.7	9	17	54	4	●
5601R38414GM-0600		6	6	5.7	10	18	54	4	●
5601R38414GM-0800		8	8	7.7	12	22	58	4	●
5601R38414GM-1000		10	10	9.5	14	26	66	4	●
5601R38414GM-1200		12	12	11.5	16	28	73	4	●
5601R38414GM-1400		14	14	13.5	18	30	75	4	●
5601R38414GM-1600		16	16	15.5	22	34	82	4	●
5601R38414GM-1800		18	18	17.5	24	36	84	4	●
5601R38414GM-2000		20	20	19.5	26	42	92	4	●

- Ex stock ○ On demand
- * With internal cooling

Application field					
P	M	K	N	S	H
✓	✓	✓			✓

- ✓ Very suitable
- ✓ Suitable

System code > B278

Cutting data > B492

Nonstandard order > B541



A

Turning

B

Milling

C

Drilling

D

Technical Information

E

Index

A

End mill long cutting edge HSC/HPC machining

5602R38414GM

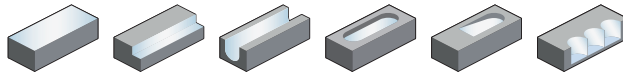

- Type of shank: DIN 6535HB
- Centre cutting
- Helix angle 38°/41°



Turning

B

Article	*	Dimensions [mm]						Teeth	Grade	
		D	d (h6)	d ₁	H	M	L		KMG405	KMG406
5602R38414GM-0400		4	6	3.7	11	19	57	4	●	●
5602R38414GM-0500		5	6	4.7	13	21	57	4	●	●
5602R38414GM-0600		6	6	5.7	13	21	57	4	●	●
5602R38414GM-0800		8	8	7.7	19	27	63	4	●	●
5602R38414GM-1000		10	10	9.5	22	32	72	4	●	●
5602R38414GM-1200		12	12	11.5	26	38	83	4	●	●
5602R38414GM-1400		14	14	13.5	26	38	83	4	●	●
5602R38414GM-1600		16	16	15.5	32	44	92	4	●	●
5602R38414GM-1800		18	18	17.5	32	44	92	4	●	●
5602R38414GM-2000		20	20	19.5	38	54	104	4	●	●

- Ex stock ○ On demand
- * With internal cooling

Milling

C

Application field

P	M	K	N	S	H
✓	✓	✓			✓

- ✓ Very suitable
- ✓ Suitable

Drilling

D

Technical Information

E

Index

System code > B278

Cutting data > B492

Nonstandard order > B541

Torus mill long cutting edge **HSC/HPC machining**

5502R38414GM-R

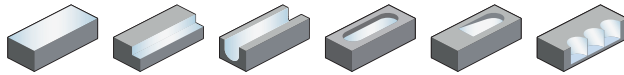

- Type of shank DIN 6535HA
- Centre cutting
- Helix angle 38°/41°

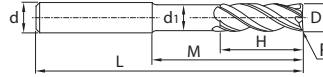

Article	*	Dimensions [mm]							Teeth	Grade KMG405
		D	R	d (h6)	d ₁	H	M	L		
5502R38414GM-R02-0400		4	0.2	6	3.7	11	19	57	4	●
5502R38414GM-R05-0400		4	0.5	6	3.7	11	19	57	4	●
5502R38414GM-R02-0500		5	0.2	6	4.7	13	21	57	4	●
5502R38414GM-R05-0500		5	0.5	6	4.7	13	21	57	4	●
5502R38414GM-R02-0600		6	0.2	6	5.7	13	21	57	4	●
5502R38414GM-R05-0600		6	0.5	6	5.7	13	21	57	4	●
5502R38414GM-R10-0600		6	1	6	5.7	13	21	57	4	●
5502R38414GM-R02-0800		8	0.2	8	7.7	19	27	63	4	●
5502R38414GM-R05-0800		8	0.5	8	7.7	19	27	63	4	●
5502R38414GM-R10-0800		8	1	8	7.7	19	27	63	4	●
5502R38414GM-R15-0800		8	1.5	8	7.7	19	27	63	4	●
5502R38414GM-R20-0800		8	2	8	7.7	19	27	63	4	●
5502R38414GM-R02-1000		10	0.2	10	9.5	22	32	72	4	●
5502R38414GM-R05-1000		10	0.5	10	9.5	22	32	72	4	●
5502R38414GM-R10-1000		10	1	10	9.5	22	32	72	4	●
5502R38414GM-R15-1000		10	1.5	10	9.5	22	32	72	4	●
5502R38414GM-R20-1000		10	2	10	9.5	22	32	72	4	●
5502R38414GM-R05-1200		12	0.5	12	11.5	26	38	83	4	●
5502R38414GM-R10-1200		12	1	12	11.5	26	38	83	4	●
5502R38414GM-R15-1200		12	1.5	12	11.5	26	38	83	4	●
5502R38414GM-R20-1200		12	2	12	11.5	26	38	83	4	●
5502R38414GM-R10-1600		16	1	16	15.5	32	44	92	4	●
5502R38414GM-R15-1600		16	1.5	16	15.5	32	44	92	4	●
5502R38414GM-R20-1600		16	2	16	15.5	32	44	92	4	●
5502R38414GM-R30-1600		16	3	16	15.5	32	44	92	4	●
5502R38414GM-R10-2000		20	1	20	19.5	38	54	104	4	●
5502R38414GM-R15-2000		20	1.5	20	19.5	38	54	104	4	●
5502R38414GM-R20-2000		20	2	20	19.5	38	54	104	4	●
5502R38414GM-R30-2000		20	3	20	19.5	38	54	104	4	●

● Ex stock ○ On demand

* With internal cooling

Application field

P	M	K	N	S	H
✓	✓	✓			✓

✓ Very suitable

✓ Suitable

System code > B278

Cutting data > B492

Nonstandard order > B541



A

Torus mill long cutting edge HSC/HPC machining

5602R38414GM-R

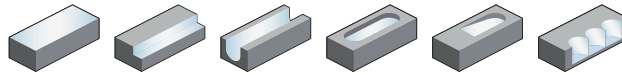

- Type of shank: DIN 6535HB
- Centre cutting
- Helix angle 38°/41°

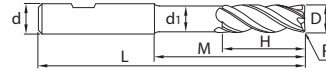

Turning

B

Article	*	Dimensions [mm]							Teeth	Grade
		D	R	d (h6)	d ₁	H	M	L		KMG405
5602R38414GM-R02-0400		4	0.2	6	3.7	11	19	57	4	●
5602R38414GM-R05-0400		4	0.5	6	3.7	11	19	57	4	●
5602R38414GM-R02-0500		5	0.2	6	4.7	13	21	57	4	●
5602R38414GM-R05-0500		5	0.5	6	4.7	13	21	57	4	●
5602R38414GM-R02-0600		6	0.2	6	5.7	13	21	57	4	●
5602R38414GM-R05-0600		6	0.5	6	5.7	13	21	57	4	●
5602R38414GM-R10-0600		6	1	6	5.7	13	21	57	4	●
5602R38414GM-R02-0800		8	0.2	8	7.7	19	27	63	4	●
5602R38414GM-R05-0800		8	0.5	8	7.7	19	27	63	4	●
5602R38414GM-R10-0800		8	1	8	7.7	19	27	63	4	●
5602R38414GM-R15-0800		8	1.5	8	7.7	19	27	63	4	●
5602R38414GM-R20-0800		8	2	8	7.7	19	27	63	4	●
5602R38414GM-R02-1000		10	0.2	10	9.5	22	32	72	4	●
5602R38414GM-R05-1000		10	0.5	10	9.5	22	32	72	4	●
5602R38414GM-R10-1000		10	1	10	9.5	22	32	72	4	●
5602R38414GM-R15-1000		10	1.5	10	9.5	22	32	72	4	●
5602R38414GM-R20-1000		10	2	10	9.5	22	32	72	4	●
5602R38414GM-R05-1200		12	0.5	12	11.5	26	38	83	4	●
5602R38414GM-R10-1200		12	1	12	11.5	26	38	83	4	●
5602R38414GM-R15-1200		12	1.5	12	11.5	26	38	83	4	●
5602R38414GM-R20-1200		12	2	12	11.5	26	38	83	4	●
5602R38414GM-R10-1600		16	1	16	15.5	32	44	92	4	●
5602R38414GM-R15-1600		16	1.5	16	15.5	32	44	92	4	●
5602R38414GM-R20-1600		16	2	16	15.5	32	44	92	4	●
5602R38414GM-R30-1600		16	3	16	15.5	32	44	92	4	●
5602R38414GM-R10-2000		20	1	20	19.5	38	54	104	4	●
5602R38414GM-R15-2000		20	1.5	20	19.5	38	54	104	4	●
5602R38414GM-R20-2000		20	2	20	19.5	38	54	104	4	●
5602R38414GM-R30-2000		20	3	20	19.5	38	54	104	4	●

● Ex stock ○ On demand

* With internal cooling

Milling

C

Drilling

D

Technical Information

E

Index

Application field

P	M	K	N	S	H
✓	✓	✓			✓

✓ Very suitable

✓ Suitable

System code > B278

Cutting data > B492

Nonstandard order > B541

End mill **HSC/HPC machining**

UM-4E

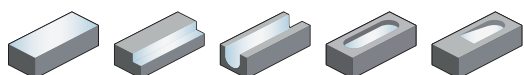

- Factory standard
- Centre cutting
- Helix angle 38°/41°

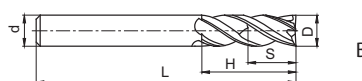
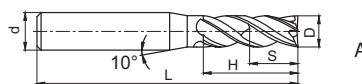

Article	*	Dimensions [mm]					Teeth	Geometry	Grade	
		D	d (h6)	H	L	S			KMG405	YK40F
UM-4E-D4.0S		4	4	11	50	6	4	B	●	
UM-4E-D4.0		4	6	11	50	6	4	A	●	
UM-4E-D4.5		4.5	6	11	50	6.75	4	A	●	
UM-4E-D5.0		5	6	13	50	7.5	4	A	●	
UM-4E-D5.5		5.5	6	16	50	8.25	4	A	●	
UM-4E-D6.0		6	6	16	50	9	4	B	●	○
UM-4E-D7.0		7	8	20	60	10.5	4	A	●	
UM-4E-D8.0		8	8	20	60	12	4	B	●	○
UM-4E-D9.0		9	10	22	75	13.5	4	A	●	
UM-4E-D10.0		10	10	25	75	15	4	B	●	○
UM-4E-D11.0		11	12	26	75	16.5	4	A	●	
UM-4E-D12.0		12	12	30	75	18	4	B	●	○
UM-4E-D14.0		14	14	32	75	21	4	B	●	
UM-4E-D16.0		16	16	45	100	24	4	B	●	○
UM-4E-D18.0		18	18	45	100	27	4	B	●	
UM-4E-D20.0		20	20	45	100	30	4	B	●	

● Ex stock ○ On demand

* With internal cooling

Application field					
P	M	K	N	S	H
✓	✓	✓			✓

✓ Very suitable

✓ Suitable

System code > B278

Cutting data > B492

Nonstandard order > B541



A

End mill

HSC/HPC machining

Turning

UM-4E-W

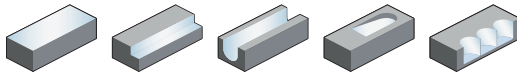

- Factory standard with weldon clamping surface
- Centre cutting
- Helix angle 38°/41°

B

Milling

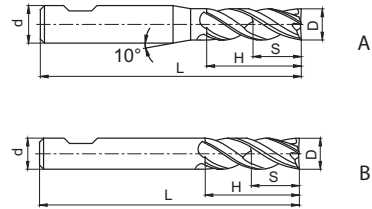

C

Drilling

Article	*	Dimensions [mm]					Teeth	Geometry	Grade	
		D	d (h6)	H	L	S			KMG405	YK40F
UM-4E-D4.0-W		4	6	11	50	6	4	A	●	
UM-4E-D4.5-W		4.5	6	11	50	6.75	4	A	●	
UM-4E-D5.0-W		5	6	13	50	7.5	4	A	●	
UM-4E-D5.5-W		5.5	6	16	50	8.25	4	A	●	
UM-4E-D6.0-W		6	6	16	50	9	4	B	●	○
UM-4E-D7.0-W		7	8	20	60	10.5	4	A	●	
UM-4E-D8.0-W		8	8	20	60	12	4	B	●	○
UM-4E-D9.0-W		9	10	22	75	13.5	4	A	●	
UM-4E-D10.0-W		10	10	25	75	15	4	B	●	○
UM-4E-D11.0-W		11	12	26	75	16.5	4	A	●	
UM-4E-D12.0-W		12	12	30	75	18	4	B	●	○
UM-4E-D14.0-W		14	14	32	75	21	4	B	●	○
UM-4E-D16.0-W		16	16	45	100	24	4	B	●	○
UM-4E-D18.0-W		18	18	45	100	27	4	B	●	
UM-4E-D20.0-W		20	20	45	100	30	4	B	●	

● Ex stock ○ On demand

* With internal cooling

D

Technical Information

Application field

P	M	K	N	S	H
✓	✓	✓			✓

✓ Very suitable

✓ Suitable

F

Index

System code > B278

Cutting data > B492

Nonstandard order > B541

End mill long cutting edge **HSC/HPC machining**

UM-4EL

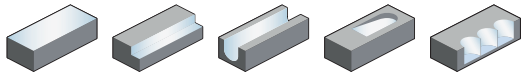

- Factory standard
- Centre cutting
- Helix angle 38°/41°

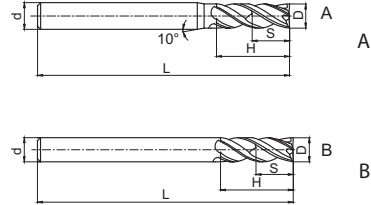

Article	*	Dimensions [mm]					Teeth	Geometry	Grade
		D	d (h6)	H	L	S			KMG405
UM-4EL-D4.0		4	6	15	75	6	4	A	●
UM-4EL-D5.0		5	6	20	75	7.5	4	A	●
UM-4EL-D6.0		6	6	20	75	9	4	B	●
UM-4EL-D8.0		8	8	25	100	12	4	B	●
UM-4EL-D10.0		10	10	30	100	15	4	B	●
UM-4EL-D12.0		12	12	35	100	18	4	B	●
UM-4EL-D14.0		14	14	40	100	21	4	B	●
UM-4EL-D16.0		16	16	50	150	24	4	B	●
UM-4EL-D20.0		20	20	55	150	30	4	B	●

● Ex stock ○ On demand

* With internal cooling

Application field					
P	M	K	N	S	H
✓	✓	✓			✓

- ✓ Very suitable
- ✓ Suitable

A

Turning

B

Milling

C

Drilling

D

Technical Information

E

Index

System code > B278

Cutting data > B492

Nonstandard order > B541



A

End mill long cutting edge HSC/HPC machining

UM-4EL-W

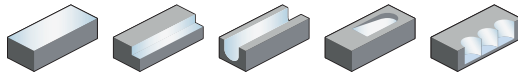

- Factory standard with weldon clamping surface
- Centre cutting
- Helix angle 38°/41°

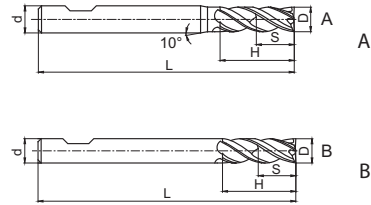

Turning

B

Milling

Article	*	Dimensions [mm]					Teeth	Geometry	Grade
		D	d (h6)	H	L	S			KMG405
UM-4EL-D4.0-W		4	6	15	75	6	4	A	●
UM-4EL-D5.0-W		5	6	20	75	7.5	4	A	●
UM-4EL-D6.0-W		6	6	20	75	9	4	B	●
UM-4EL-D8.0-W		8	8	25	100	12	4	B	●
UM-4EL-D10.0-W		10	10	30	100	15	4	B	●
UM-4EL-D12.0-W		12	12	35	100	18	4	B	●
UM-4EL-D14.0-W		14	14	40	100	21	4	B	●
UM-4EL-D16.0-W		16	16	50	150	24	4	B	●
UM-4EL-D20.0-W		20	20	55	150	30	4	B	●

● Ex stock ○ On demand

* With internal cooling

C

Drilling

Application field

P	M	K	N	S	H
✓	✓	✓			✓

✓ Very suitable

✓ Suitable

D

Technical Information

E

Index

System code > B278

Cutting data > B492

Nonstandard order > B541

End mill reduced neck **HSC/HPC machining**

UM-4ELP-W

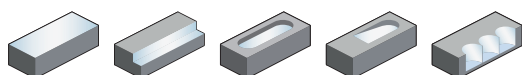

- Factory standard with weldon clamping surface
- Centre cutting
- Helix angle 38°/41°

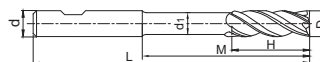

Article	*	Dimensions [mm]						Teeth	Grade
		D	d (h6)	d ₁	H	M	L		KMG405
UM-4ELP-D4.0-W		4	6	3.8	15	36	75	4	●
UM-4ELP-D5.0-W		5	6	4.8	20	36	75	4	●
UM-4ELP-D6.0-W		6	6	5.7	20	36	75	4	●
UM-4ELP-D8.0-W		8	8	7.7	25	60	100	4	●
UM-4ELP-D10.0-W		10	10	9.5	30	55	100	4	●
UM-4ELP-D12.0-W		12	12	11.5	35	50	100	4	●
UM-4ELP-D14.0-W		14	14	13.5	40	50	100	4	●
UM-4ELP-D16.0-W		16	16	15.5	50	100	150	4	●
UM-4ELP-D20.0-W		20	20	19.5	55	98	150	4	●

● Ex stock ○ On demand

* With internal cooling

Application field

P	M	K	N	S	H
✓	✓	✓			✓

✓ Very suitable

✓ Suitable

A

Turning

B

Milling

C

Drilling

D

Technical Information

E

Index

System code > B278

Cutting data > B492

Nonstandard order > B541

A

End mill short cutting edge HSC/HPC machining

UM-4EFP

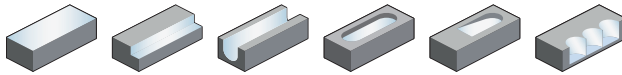

- Factory standard
- Centre cutting
- Helix angle 38°/41°

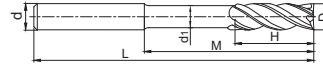

Turning

B

Article	*	Dimensions [mm]						Teeth	Grade
		D	d (h6)	d ₁	H	M	L		KMG405
UM-4EFP-D6.0		6	6	5.8	9	30	75	4	●
UM-4EFP-D8.0		8	8	7.8	12	40	100	4	●
UM-4EFP-D10.0		10	10	9.6	15	50	100	4	●
UM-4EFP-D12.0		12	12	11.5	18	50	100	4	●
UM-4EFP-D16.0		16	16	15.5	24	50	150	4	●
UM-4EFP-D20.0		20	20	19.5	30	60	150	4	●

- Ex stock ○ On demand
- * With internal cooling

Milling

C

Application field						
P	M	K	N	S	H	
✓	✓	✓			✓	✓ Very suitable
						✓ Suitable

Drilling

D

Technical Information

E

Index

System code > B278

Cutting data > B492

Nonstandard order > B541

End mill **HSC/HPC machining**

UM-4R

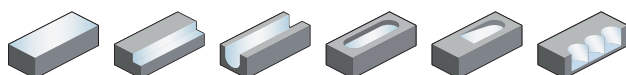

- Factory standard
- Centre cutting
- Helix angle 38°/41°

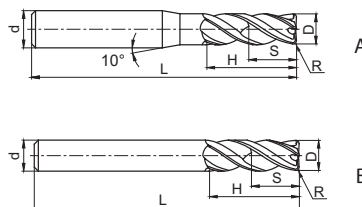

Article	*	Dimensions [mm]						Teeth	Geometry	Grade
		R	D	d (h6)	H	L	S			KMG405
UM-4R-D4.0R0.3		0.3	4	6	10	50	6	4	A	●
UM-4R-D4.0R0.5		0.5	4	6	10	50	6	4	A	●
UM-4R-D5.0R0.5		0.5	5	6	13	50	7.5	4	A	●
UM-4R-D5.0R1.0		1	5	6	13	50	7.5	4	A	●
UM-4R-D6.0R0.5		0.5	6	6	16	50	9	4	B	●
UM-4R-D6.0R1.0		1	6	6	16	50	9	4	B	●
UM-4R-D8.0R0.5		0.5	8	8	20	60	12	4	B	●
UM-4R-D8.0R1.0		1	8	8	20	60	12	4	B	●
UM-4R-D10.0R0.5		0.5	10	10	25	75	15	4	B	●
UM-4R-D10.0R1.0		1	10	10	25	75	15	4	B	●
UM-4R-D10.0R2.0		2	10	10	25	75	15	4	B	●
UM-4R-D10.0R3.0		3	10	10	25	75	15	4	B	●
UM-4R-D12.0R0.5		0.5	12	12	30	75	18	4	B	●
UM-4R-D12.0R1.0		1	12	12	30	75	18	4	B	●
UM-4R-D12.0R2.0		2	12	12	30	75	18	4	B	●
UM-4R-D12.0R3.0		3	12	12	30	75	18	4	B	●
UM-4R-D16.0R0.5		0.5	16	16	45	100	24	4	B	●
UM-4R-D16.0R1.0		1	16	16	45	100	24	4	B	●
UM-4R-D16.0R2.0		2	16	16	45	100	24	4	B	●
UM-4R-D16.0R3.0		3	16	16	45	100	24	4	B	●
UM-4R-D20.0R1.0		1	20	20	45	100	30	4	B	●
UM-4R-D20.0R2.0		2	20	20	45	100	30	4	B	●
UM-4R-D20.0R3.0		3	20	20	45	100	30	4	B	●

● Ex stock ○ On demand

* With internal cooling

Application field					
P	M	K	N	S	H
✓	✓	✓			✓

- ✓ Very suitable
- ✓ Suitable

System code > B278

Cutting data > B492

Nonstandard order > B541



A

Turning

B

Milling

C

Drilling

D

Technical Information

E

Index

A

Torus mill long shank HSC/HPC machining

UM-4RL

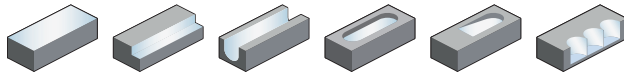

- Factory standard
- Centre cutting
- Helix angle 38°/41°

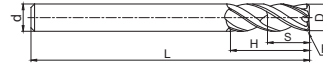

Turning

B

Article	*	Dimensions [mm]						Teeth	Grade
		R	D	d (h6)	H	L	S		KMG405
UM-4RL-D6.0R0.5		0.5	6	6	16	75	9	4	●
UM-4RL-D6.0R1.0		1	6	6	16	75	9	4	●
UM-4RL-D8.0R0.5		0.5	8	8	20	100	12	4	●
UM-4RL-D8.0R1.0		1	8	8	20	100	12	4	●
UM-4RL-D10.0R0.5		0.5	10	10	25	100	15	4	●
UM-4RL-D10.0R1.0		1	10	10	25	100	15	4	●
UM-4RL-D10.0R2.0		2	10	10	25	100	15	4	●
UM-4RL-D12.0R0.5		0.5	12	12	30	100	18	4	●
UM-4RL-D12.0R1.0		1	12	12	30	100	18	4	●
UM-4RL-D12.0R2.0		2	12	12	30	100	18	4	●
UM-4RL-D16.0R1.0		1	16	16	45	150	24	4	●
UM-4RL-D16.0R2.0		2	16	16	45	150	24	4	●

- Ex stock ○ On demand
- * With internal cooling

Milling

C

Application field						
P	M	K	N	S	H	
✓	✓	✓			✓	✓ Very suitable ✓ Suitable

Drilling

D

Technical Information

E

Index

System code > B278

Cutting data > B492

Nonstandard order > B541

Torus mill short cutting edge **HSC/HPC machining**

UM-4RFP

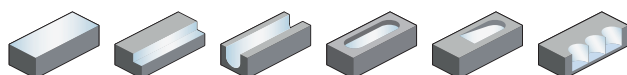

- Factory standard
- Centre cutting
- Helix angle 38°/41°

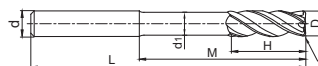

Article	*	Dimensions [mm]							Teeth	Grade
		R	D	d (h6)	d ₁	H	M	L		
UM-4RFP-D6.0R0.5		0.5	6	6	5.8	6	18	75	4	●
UM-4RFP-D6.0R1.0		1	6	6	5.8	6	18	75	4	●
UM-4RFP-D8.0R0.5		0.5	8	8	7.7	8	24	100	4	●
UM-4RFP-D8.0R1.0		1	8	8	7.7	8	24	100	4	●
UM-4RFP-D10.0R0.5		0.5	10	10	9.6	10	30	100	4	●
UM-4RFP-D10.0R1.0		1	10	10	9.6	10	30	100	4	●
UM-4RFP-D10.0R2.0		2	10	10	9.6	10	30	100	4	●
UM-4RFP-D12.0R0.5		0.5	12	12	11.5	12	36	100	4	●
UM-4RFP-D12.0R1.0		1	12	12	11.5	12	36	100	4	●
UM-4RFP-D12.0R2.0		2	12	12	11.5	12	36	100	4	●
UM-4RFP-D16.0R1.0		1	16	16	15.5	16	40	150	4	●
UM-4RFP-D16.0R2.0		2	16	16	15.5	16	40	150	4	●

● Ex stock ○ On demand

* With internal cooling

Application field

P	M	K	N	S	H
✓	✓	✓			✓

✓ Very suitable

✓ Suitable

System code > B278

Cutting data > B492

Nonstandard order > B541



A

End mill

HSC/HPC machining

Turning

UM-5EP-W

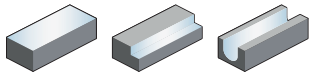

- Factory standard with weldon clamping surface
- Non-centre cutting
- Helix angle 38°/39°/40°

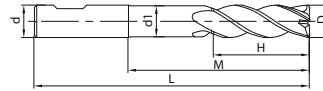

B

Milling

Article	*	Dimensions [mm]						Grade
		D	d (h6)	d ₁	H	M	L	KMG405
UM-5EP-D6.0-W		6	6	5.7	16	22	58	●
UM-5EP-D8.0-W		8	8	7.7	21	27	63	●
UM-5EP-D10.0-W		10	10	9.5	24	35	75	●
UM-5EP-D12.0-W		12	12	11.5	31	43	88	●
UM-5EP-D16.0-W		16	16	15.5	36	52	100	●
UM-5EP-D20.0-W		20	20	19.5	41	72	126	●
UM-5EP-D25.0-W		25	25	24	51	102	160	○

● Ex stock ○ On demand

* With internal cooling

C

Drilling

Application field						
P	M	K	N	S	H	
✓	✓	✓			✓	✓ Very suitable
						✓ Suitable

D

Technical Information

E

Index

System code > B278

Cutting data > B492

Nonstandard order > B541

End mill

HSC/HPC machining

UMC-4E

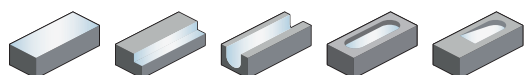

- Factory standard
- Centre cutting
- Helix angle 38°/40°

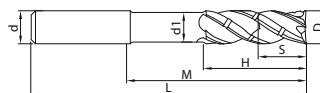
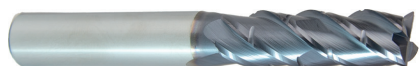

Article	*	Dimensions [mm]							Grade
		D	d (h6)	d ₁	H	M	L	S	
UMC-4E-D6.0		6	6	5.8	18	24	60	9	○
UMC-4E-D8.0		8	8	7.8	24	34	70	12	○
UMC-4E-D10.0		10	10	9.6	30	40	80	15	○
UMC-4E-D12.0		12	12	11.5	36	45	90	18	○
UMC-4E-D16.0		16	16	15.5	48	62	110	24	○
UMC-4E-D20.0		20	20	19.5	60	80	130	30	○

● Ex stock ○ On demand

* With internal cooling

Application field					
P	M	K	N	S	H
✓	✓	✓			✓

✓ Very suitable

✓ Suitable

A

Turning

B

Milling

C

Drilling

D

Technical Information

E

Index

System code > B278

Cutting data > B492

Nonstandard order > B541



A

End mill HSC/HPC machining

UMC-4E-W

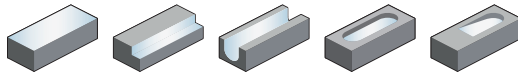

- Factory standard with weldon clamping surface
- Centre cutting
- Helix angle 38°/40°

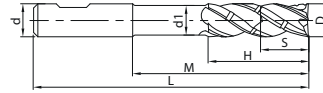

Turning

B

Article	*	Dimensions [mm]							Grade
		D	d (h6)	d ₁	H	M	L	S	KMG405
UMC-4E-D6.0-W		6	6	5.8	18	24	60	9	○
UMC-4E-D8.0-W		8	8	7.8	24	34	70	12	○
UMC-4E-D10.0-W		10	10	9.6	30	40	80	15	○
UMC-4E-D12.0-W		12	12	11.5	36	45	90	18	○
UMC-4E-D16.0-W		16	16	15.5	48	62	110	24	○
UMC-4E-D20.0-W		20	20	19.5	60	80	130	30	○

- Ex stock ○ On demand
- * With internal cooling

Milling

C

Application field						
P	M	K	N	S	H	
✓	✓	✓			✓	✓ Very suitable
						✓ Suitable

Drilling

D

Technical Information

E

Index

System code > B278

Cutting data > B492

Nonstandard order > B541

End mill **General machining of heat-resistant alloys**

VSM-4E

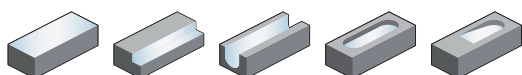

- Factory standard
- Centre cutting
- Helix angle 38°/41°

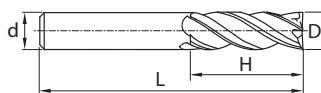

Article	*	Dimensions [mm]				Teeth	Grade
		D	d (h6)	H	L		KMG405
VSM-4E-D4.0		4	6	11	50	4	●
VSM-4E-D5.0		5	6	13	50	4	●
VSM-4E-D6.0		6	6	16	50	4	●
VSM-4E-D8.0		8	8	20	60	4	●
VSM-4E-D10.0		10	10	25	75	4	●
VSM-4E-D12.0		12	12	30	75	4	●
VSM-4E-D16.0		16	16	45	100	4	●
VSM-4E-D20.0		20	20	45	100	4	●

● Ex stock ○ On demand

* With internal cooling

Application field					
P	M	K	N	S	H
✓	✓			✓	

✓ Very suitable

✓ Suitable

A

Turning

B

Milling

C

Drilling

D

Technical Information

E

Index

System code > B278

Cutting data > B492

Nonstandard order > B541



A

End mill General machining of heat-resistant alloys

VSM-4E-C

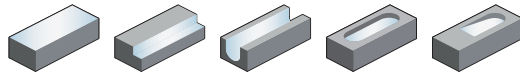

- Factory standard
- Coolant exit, radial
- Centre cutting
- Helix angle 38°/41°

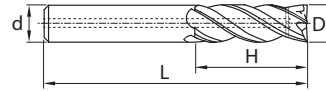

Turning

B

Article	*	Dimensions [mm]				Teeth	Grade
		D	d (h6)	H	L		KMG405
VSM-4E-C-D10.0	*	10	10	25	75	4	○
VSM-4E-C-D12.0	*	12	12	30	75	4	○
VSM-4E-C-D16.0	*	16	16	45	100	4	○
VSM-4E-C-D20.0	*	20	20	45	100	4	○

● Ex stock ○ On demand

* With internal cooling

Milling

C

Application field

P	M	K	N	S	H
✓	✓			✓	

✓ Very suitable

✓ Suitable

Drilling

D

Technical Information

E

Index

System code > B278

Cutting data > B492

Nonstandard order > B541

Torus mill **General machining of heat-resistant alloys**

VSM-4R

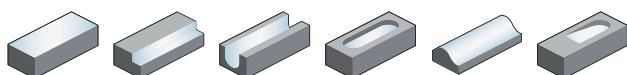

- Factory standard
- Centre cutting
- Helix angle 38°/41°

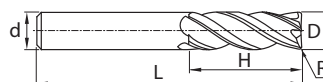

Article	*	Dimensions [mm]					Teeth	Grade KMG405
		D	R	d (h6)	H	L		
VSM-4R-D4.0R0.2		4	0.2	6	11	50	4	●
VSM-4R-D4.0R0.5		4	0.5	6	11	50	4	●
VSM-4R-D5.0R0.2		5	0.2	6	13	50	4	●
VSM-4R-D5.0R0.5		5	0.5	6	13	50	4	●
VSM-4R-D6.0R0.2		6	0.2	6	16	50	4	●
VSM-4R-D6.0R0.5		6	0.5	6	16	50	4	●
VSM-4R-D6.0R1.0		6	1	6	16	50	4	●
VSM-4R-D6.0R1.5		6	1.5	6	16	50	4	●
VSM-4R-D8.0R0.5		8	0.5	8	20	63	4	●
VSM-4R-D8.0R0.8		8	0.8	8	20	63	4	●
VSM-4R-D8.0R1.0		8	1	8	20	63	4	●
VSM-4R-D8.0R1.5		8	1.5	8	20	63	4	●
VSM-4R-D8.0R2.0		8	2	8	20	63	4	●
VSM-4R-D10.0R0.5		10	0.5	10	25	75	4	●
VSM-4R-D10.0R0.8		10	0.8	10	25	75	4	●
VSM-4R-D10.0R1.0		10	1	10	25	75	4	●
VSM-4R-D10.0R1.5		10	1.5	10	25	75	4	●
VSM-4R-D10.0R2.0		10	2	10	25	75	4	●
VSM-4R-D12.0R0.5		12	0.5	12	30	75	4	●
VSM-4R-D12.0R0.8		12	0.8	12	30	75	4	●
VSM-4R-D12.0R1.0		12	1	12	30	75	4	●
VSM-4R-D12.0R1.5		12	1.5	12	30	75	4	●
VSM-4R-D12.0R2.0		12	2	12	30	75	4	●
VSM-4R-D12.0R2.5		12	2.5	12	30	75	4	●
VSM-4R-D12.0R3.0		12	3	12	30	75	4	●
VSM-4R-D12.0R4.0		12	4	12	30	75	4	●
VSM-4R-D16.0R0.5		16	0.5	16	45	100	4	●
VSM-4R-D16.0R0.8		16	0.8	16	45	100	4	●
VSM-4R-D16.0R1.0		16	1	16	45	100	4	●
VSM-4R-D16.0R1.5		16	1.5	16	45	100	4	●
VSM-4R-D16.0R2.0		16	2	16	45	100	4	●
VSM-4R-D16.0R2.5		16	2.5	16	45	100	4	●
VSM-4R-D16.0R3.0		16	3	16	45	100	4	●
VSM-4R-D16.0R4.0		16	4	16	45	100	4	●
VSM-4R-D20.0R0.5		20	0.5	20	45	100	4	●
VSM-4R-D20.0R1.0		20	1	20	45	100	4	●
VSM-4R-D20.0R1.5		20	1.5	20	45	100	4	●

● Ex stock ○ On demand

* With internal cooling

Application field					
P	M	K	N	S	H
✓	✓			✓	

✓ Very suitable

✓ Suitable

System code > B278 Cutting data > B492 Nonstandard order > B541



A

Turning

B

Milling

C

Drilling

D

Technical Information

E

Index

A

Torus mill **General machining of heat-resistant alloys**

VSM-4R

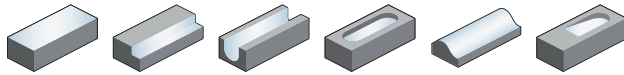

- Factory standard
- Centre cutting
- Helix angle 38°/41°

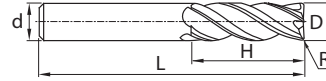

Turning

B

Article	*	Dimensions [mm]					Teeth	Grade
		D	R	d (h6)	H	L		KMG405
VSM-4R-D20.0R2.0		20	2	20	45	100	4	●
VSM-4R-D20.0R2.5		20	2.5	20	45	100	4	●
VSM-4R-D20.0R3.0		20	3	20	45	100	4	●
VSM-4R-D20.0R4.0		20	4	20	45	100	4	●

● Ex stock ○ On demand

* With internal cooling

Milling

C

Application field

P	M	K	N	S	H
✓	✓			✓	

✓ Very suitable

✓ Suitable

Drilling

D

Technical Information

E

Index

System code > B278

Cutting data > B492

Nonstandard order > B541

Deburring cutter 60°

General machining

5501/5601R60*FM



- Type of shank DIN 6535HA
- Type of shank: DIN 6535HB
- Non-centre cutting
- Helix angle 0°

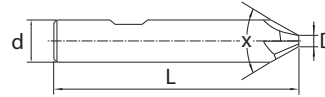

Article	*	Dimensions [mm]					Teeth	Grade
		d(h6)	L	D	Shank	X		KMG303
5501R603FM-0300		3	48	0.2	HA	60	3	●
5501R604FM-0400		4	48	0.2	HA	60	4	●
5601R604FM-0600		6	55	0.2	HB	60	4	●
5601R604FM-0800		8	58	0.5	HB	60	4	●
5601R604FM-1000		10	65	0.5	HB	60	4	●
5601R606FM-1000		10	65	0.7	HB	60	6	○
5601R604FM-1200		12	75	0.5	HB	60	4	●
5601R606FM-1200		12	75	0.7	HB	60	6	○
5601R604FM-1600		16	85	0.7	HB	60	4	●
5601R606FM-1600		16	85	0.7	HB	60	6	○

● Ex stock ○ On demand

* With internal cooling

Application field					
P	M	K	N	S	H
✓	✓	✓	✓		

- ✓ Very suitable
- ✓ Suitable

System code > B278

Cutting data > B492

Nonstandard order > B541



A

Turning

B

Milling

C

Drilling

D

Technical Information

E

Index

A

Deburring cutter 90° General machining

5501/5601R90*FM



- Type of shank DIN 6535HA
- Type of shank: DIN 6535HB
- Non-centre cutting
- Helix angle 0°

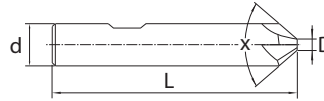

Turning

B

Article	*	Dimensions [mm]					Teeth	Grade
		d(h6)	L	D	Shank	X		KMG303
5501R903FM-0300		3	48	0.2	HA	90	3	●
5501R904FM-0400		4	48	0.2	HA	90	4	●
5601R904FM-0600		6	55	0.2	HB	90	4	●
5601R904FM-0800		8	58	0.5	HB	90	4	●
5601R904FM-1000		10	65	0.5	HB	90	4	●
5601R906FM-1000		10	65	0.7	HB	90	6	○
5601R904FM-1200		12	75	0.5	HB	90	4	●
5601R906FM-1200		12	75	0.7	HB	90	6	○
5501R904FM-1600		16	85	0.7	HA	90	4	○
5601R904FM-1600		16	85	0.7	HB	90	4	●
5601R906FM-1600		16	85	0.7	HB	90	6	○

● Ex stock ○ On demand

* With internal cooling

Milling

C

Application field

P	M	K	N	S	H
✓	✓	✓	✓		

✓ Very suitable

✓ Suitable

Drilling

D

Technical Information

E

Index

System code > B278

Cutting data > B492

Nonstandard order > B541

Deburring cutter

General machining

5501/5601R120*FM



- Type of shank DIN 6535HA
- Type of shank: DIN 6535HB
- Non-centre cutting
- Helix angle 0°

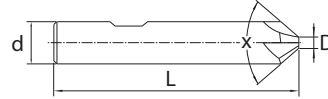

Article	*	Dimensions [mm]					Teeth	Grade
		d(h6)	L	D	Shank	X		KMG406
5501R1203FM-0300		3	48	0.2	HA	120	3	○
5501R1204FM-0400		4	48	0.2	HA	120	4	○
5501R1204FM-0600		6	55	0.2	HA	120	4	○
5601R1204FM-0600		6	55	0.2	HB	120	4	○
5501R1204FM-0800		8	58	0.5	HA	120	4	○
5601R1204FM-0800		8	58	0.5	HB	120	4	○
5501R1204FM-1000		10	65	0.5	HA	120	4	○
5601R1204FM-1000		10	65	0.5	HB	120	4	○
5601R1206FM-1000		10	65	0.7	HB	120	6	○
5501R1206FM-1000		10	65	0.7	HA	120	6	○
5501R1204FM-1200		12	75	0.5	HA	120	4	○
5601R1204FM-1200		12	75	0.5	HB	120	4	○
5601R1206FM-1200		12	75	0.7	HB	120	6	○
5501R1206FM-1200		12	75	0.7	HA	120	6	○
5501R1206FM-1600		16	85	0.7	HA	120	6	○
5601R1204FM-1600		16	85	0.7	HB	120	4	○
5501R1204FM-1600		16	85	0.7	HA	120	4	○
5601R1206FM-1600		16	85	0.7	HB	120	6	○

● Ex stock ○ On demand

* With internal cooling

Application field					
P	M	K	N	S	H
✓	✓	✓	✓		

✓ Very suitable

✓ Suitable

System code > B278

Cutting data > B492

Nonstandard order > B541



A

Quarter round profile mill

General machining

Turning

5601R90*FM-R



- Type of shank: DIN 6535HB
- Non-centre cutting
- Helix angle 0°

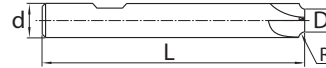

B

Milling

Article	*	Dimensions [mm]				Teeth	Grade
		d(h6)	L	D	R		KMG303
5601R904FM-R02-0600		6	60	5.6	0.2	4	●
5601R904FM-R03-0600		6	60	5.4	0.3	4	●
5601R904FM-R04-0600		6	60	5.2	0.4	4	●
5601R904FM-R05-0800		8	70	7	0.5	4	●
5601R904FM-R06-0800		8	70	6.8	0.6	4	●
5601R904FM-R075-0800		8	70	6.5	0.75	4	●
5601R904FM-R08-0800		8	70	6.4	0.8	4	●
5601R904FM-R10-0800		8	70	6	1	4	●
5601R904FM-R15-1000		10	75	7	1.5	4	●
5601R904FM-R20-1000		10	75	6	2	4	●
5601R904FM-R25-1200		12	75	7	2.5	4	●
5601R904FM-R30-1200		12	75	6	3	4	●
5601R904FM-R40-1600		16	80	8	4	4	●
5601R904FM-R50-2000		20	80	10	5	4	●

● Ex stock ○ On demand

* With internal cooling

C

Drilling

Application field

P	M	K	N	S	H
✓	✓	✓	✓		

✓ Very suitable

✓ Suitable

D

Technical Information

E

Index

System code > B278

Cutting data > B492

Nonstandard order > B541

Ball nose cutter **High-performance machining**

PM-2B

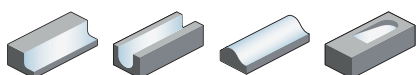

- Centre cutting
- Helix angle 30°

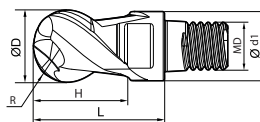
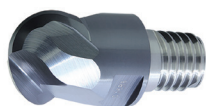

Article	*	Dimensions [mm]						Teeth	Grade
		R	D	d1	H	L	MD		KMG405
Q08-PM-2B-D12.0		6	12	11.5	7	17	8	2	●
Q10-PM-2B-D16.0		8	16	15.2	9	21.5	10	2	●
Q12-PM-2B-D20.0		10	20	19	11	25.5	12	2	●
Q14-PM-2B-D25.0		12.5	25	24	13.5	31.5	14	2	●
Q18-PM-2B-D32.0		16	32	30	17	36	18	2	●

● Ex stock ○ On demand

* With internal cooling

Application field

P	M	K	N	S	H
✓	✓	✓			✓

✓ Very suitable

✓ Suitable

A

Turning

B

Milling

C

Drilling

D

Technical Information

E

Index

System code > B278

Cutting data > B492

Nonstandard order > B541

A

Ball nose cutter High-performance machining

PM-4B

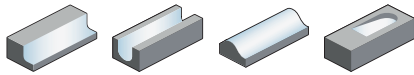

- Centre cutting
- Helix angle 30°

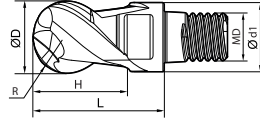

Turning

B

Article	*	Dimensions [mm]						Teeth	Grade
		R	D	d1	H	L	MD		
Q08-PM-4B-D12.0		6	12	11.5	7	17	8	4	●
Q10-PM-4B-D16.0		8	16	15.2	9	21.5	10	4	●
Q12-PM-4B-D20.0		10	20	19	11	25.5	12	4	●
Q14-PM-4B-D25.0		12.5	25	24	13.5	31.5	14	4	●
Q18-PM-4B-D32.0		16	32	30	17	36	18	4	●

● Ex stock ○ On demand

* With internal cooling

Milling

C

Application field

P	M	K	N	S	H
✓	✓	✓			✓

✓ Very suitable

✓ Suitable

Drilling

D

Technical Information

E

Index

System code > B278

Cutting data > B492

Nonstandard order > B541

Square shoulder mill **High-performance machining**

PM-4E

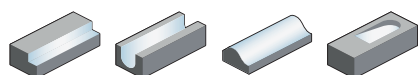

- Centre cutting
- Helix angle 45°

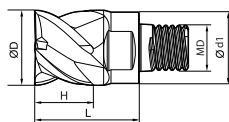
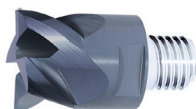

Article	*	Dimensions [mm]					Teeth	Grade
		D	d1	H	L	MD		KMG405
Q08-PM-4E-D12.0		12	11.5	7	17	8	4	●
Q10-PM-4E-D16.0		16	15.2	9	21.5	10	4	●
Q12-PM-4E-D20.0		20	19	11	25.5	12	4	●
Q14-PM-4E-D25.0		25	24	13.5	31.5	14	4	●
Q18-PM-4E-D32.0		32	30	17	36	18	4	●

● Ex stock ○ On demand

* With internal cooling

Application field

P	M	K	N	S	H
✓	✓	✓			✓

✓ Very suitable

✓ Suitable

A

Turning

B

Milling

C

Drilling

D

Technical Information

E

Index

System code > B278

Cutting data > B492

Nonstandard order > B541

A

Torus mill **High-performance machining**

PM-4R

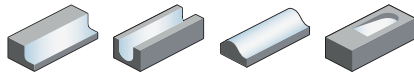

- Centre cutting
- Helix angle 30°

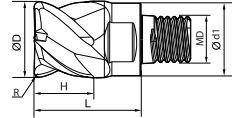

Turning

B

Article	*	Dimensions [mm]						Teeth	Grade
		R	D	d1	H	L	MD		
Q08-PM-4R-D12.0R1.0		1	12	11.5	7	17	8	4	●
Q08-PM-4R-D12.0R2.0		2	12	11.5	7	17	8	4	●
Q10-PM-4R-D16.0R1.0		1	16	15.2	9	21.5	10	4	●
Q10-PM-4R-D16.0R1.5	*	1.5	16	15.2	9	21.5	10	4	●
Q10-PM-4R-D16.0R2.0		2	16	15.2	9	21.5	10	4	●
Q12-PM-4R-D20.0R1.0		1	20	19	11	25.5	12	4	●
Q12-PM-4R-D20.0R2.0		2	20	19	11	25.5	12	4	●
Q14-PM-4R-D25.0R1.0		1	25	24	13.5	31.5	14	4	●
Q14-PM-4R-D25.0R2.0		2	25	24	13.5	31.5	14	4	●
Q14-PM-4R-D25.0R2.5	*	2.5	25	24	13.5	31.5	14	4	●
Q18-PM-4R-D32.0R1.0		1	32	30	17	36	18	4	●
Q18-PM-4R-D32.0R2.0		2	32	30	17	36	18	4	●
Q18-PM-4R-D32.0R3.0		3	32	30	17	36	18	4	●

Milling

C

- Ex stock ○ On demand
- * With internal cooling

Drilling

Application field					
P	M	K	N	S	H
✓	✓	✓			✓

✓ Very suitable
 ✓ Suitable

D

Technical Information

E

Index

System code > B278

Cutting data > B492

Nonstandard order > B541



Square shoulder mill **High-performance machining**

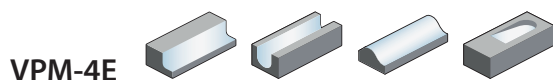

- Centre cutting
- Helix angle 38°

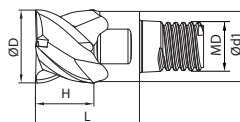
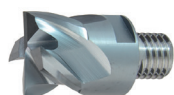

Article	*	Dimensions [mm]					Teeth	Grade
		D	d1	H	L	MD		KMG406
Q08-VPM-4E-D12.0		12	11.5	7	17	8	4	●
Q10-VPM-4E-D16.0		16	15.2	9	21.5	10	4	●
Q12-VPM-4E-D20.0		20	19	11	25.5	12	4	●
Q14-VPM-4E-D25.0		25	24	13.5	31.5	14	4	●

● Ex stock ○ On demand

* With internal cooling

Application field					
P	M	K	N	S	H
✓	✓	✓			✓

✓ Very suitable

✓ Suitable

A

Turning

B

Milling

C

Drilling

D

Technical Information

E

Index

System code > B278

Cutting data > B492

Nonstandard order > B541



A

Ball nose cutter **Hard machining**

HMX-2B

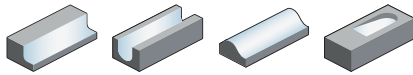

- Centre cutting
- Helix angle 35°

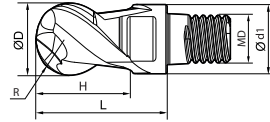

Turning

B

Article	*	Dimensions [mm]						Teeth	Grade
		R	D	d1	H	L	MD		KMG5515
Q08-HMX-2B-D12.0		6	12	11.5	7	17	8	2	●
Q10-HMX-2B-D16.0		8	16	15.2	9	21.5	10	2	●
Q12-HMX-2B-D20.0		10	20	19	11	25.5	12	2	●
Q14-HMX-2B-D25.0		12.5	25	24	13.5	31.5	14	2	●
Q18-HMX-2B-D32.0		16	32	30	17	36	18	2	●

● Ex stock ○ On demand

* With internal cooling

Milling

C

Application field

P	M	K	N	S	H
					✓

✓ Very suitable

✓ Suitable

Drilling

D

Technical Information

E

Index

System code > B278

Cutting data > B492

Nonstandard order > B541

Ball nose cutter **Hard machining**

HMX-4B

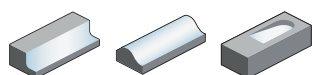

- Centre cutting
- Helix angle 35°

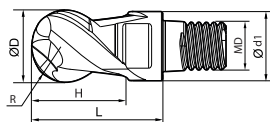

Article	*	Dimensions [mm]						Teeth	Grade
		R	D	d1	H	L	MD		
Q08-HMX-4B-D12.0		6	12	11.5	7	17	8	4	●
Q10-HMX-4B-D16.0		8	16	15.2	9	21.5	10	4	●
Q12-HMX-4B-D20.0		10	20	19	11	25.5	12	4	●
Q14-HMX-4B-D25.0		12.5	25	24	13.5	31.5	14	4	●
Q18-HMX-4B-D32.0		16	32	30	17	36	18	4	●

● Ex stock ○ On demand

* With internal cooling

Application field					
P	M	K	N	S	H
					✓

✓ Very suitable

✓ Suitable

A

Turning

B

Milling

C

Drilling

D

Technical Information

E

Index

System code > B278

Cutting data > B492

Nonstandard order > B541

A

Square shoulder mill Hard machining

HMX-4E

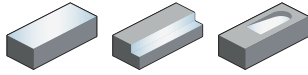

- Centre cutting
- Helix angle 45°

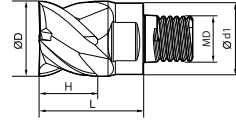

Turning

B

Article	*	Dimensions [mm]					Teeth	Grade
		D	d1	H	L	MD		KMG5515
Q08-HMX-4E-D12.0		12	11.5	7	17	8	4	●
Q10-HMX-4E-D16.0		16	15.2	9	21.5	10	4	●
Q12-HMX-4E-D20.0		20	19	11	25.5	12	4	●
Q14-HMX-4E-D25.0		25	24	13.5	31.5	14	4	●
Q18-HMX-4E-D32.0		32	30	17	36	18	4	●

● Ex stock ○ On demand

* With internal cooling

Milling

C

Application field					
P	M	K	N	S	H
					✓

✓ Very suitable
 ✓ Suitable

Drilling

D

Technical Information

E

Index

System code > B278

Cutting data > B492

Nonstandard order > B541

Torus mill

Hard machining

HMX-4R

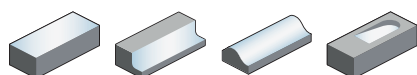

- Centre cutting
- Helix angle 35°

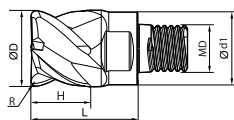

Article	*	Dimensions [mm]						Teeth	Grade
		R	D	d1	H	L	MD		KMG405
Q08-HMX-4R-D12.0R1.0		1	12	11.5	7	17	8	4	●
Q08-HMX-4R-D12.0R2.0		2	12	11.5	7	17	8	4	●
Q10-HMX-4R-D16.0R1.0		1	16	15.2	9	21.5	10	4	●
Q10-HMX-4R-D16.0R1.5	*	1.5	16	15.2	9	21.5	10	4	●
Q10-HMX-4R-D16.0R2.0		2	16	15.2	9	21.5	10	4	●
Q12-HMX-4R-D20.0R1.0		1	20	19	11	25.5	12	4	●
Q12-HMX-4R-D20.0R2.0		2	20	19	11	25.5	12	4	●
Q14-HMX-4R-D25.0R1.0		1	25	24	13.5	31.5	14	4	●
Q14-HMX-4R-D25.0R2.0		2	25	24	13.5	31.5	14	4	●
Q14-HMX-4R-D25.0R2.5	*	2.5	25	24	13.5	31.5	14	4	●
Q18-HMX-4R-D32.0R1.0		1	32	30	17	36	18	4	●
Q18-HMX-4R-D32.0R2.0		2	32	30	17	36	18	4	●
Q18-HMX-4R-D32.0R3.0		3	32	30	17	36	18	4	●

● Ex stock ○ On demand

* With internal cooling

Application field					
P	M	K	N	S	H
					✓

✓ Very suitable

✓ Suitable

System code > B278

Cutting data > B492

Nonstandard order > B541



Indexable heads shanks

Solid carbide shank, stepped, Q thread

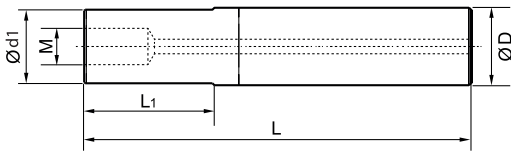

Article	Dimensions [mm]				Thread (M)	Stock
	D	d1	L	L1		
G12-QCH-Q08-80C	12	11,5	80	30	Q8	●
G12-QCH-Q08-100C	12	11,5	100	50	Q8	●
G12-QCH-Q08-120C	12	11,5	120	70	Q8	●
G16-QCH-Q10-90C	16	15,2	90	40	Q10	●
G16-QCH-Q10-120C	16	15,2	120	70	Q10	●
G16-QCH-Q10-150C	16	15,2	150	100	Q10	●
G20-QCH-Q12-100C	20	19	100	40	Q12	●
G20-QCH-Q12-140C	20	19	140	80	Q12	●
G20-QCH-Q12-180C	20	19	180	120	Q12	●
G25-QCH-Q14-120C	25	24	120	50	Q14	●
G25-QCH-Q14-170C	25	24	170	100	Q14	●
G25-QCH-Q14-220C	25	24	220	150	Q14	●
G32-QCH-Q18-140C	32	30	140	70	Q18	●
G32-QCH-Q18-200C	32	30	200	130	Q18	●
G32-QCH-Q18-260C	32	30	260	190	Q18	●
G32-QCH-Q18-320C	32	30	320	250	Q18	●

Solid carbide shank, tapered, Q thread

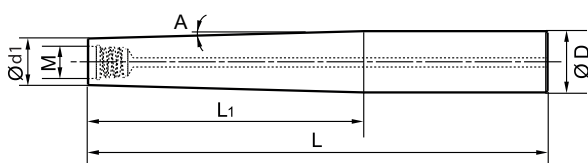

Article	Dimensions [mm]				Thread (M)	Angle (A)	Stock
	D	d1	L	L1			
G16-QCH-Q08-140C-ZJ90	16	11,5	140	90	Q8	1,0	●
G20-QCH-Q10-200C-ZJ140	20	15,2	200	140	Q8	0,8	●
G25-QCH-Q12-250C-ZJ180	25	19	250	180	Q8	0,8	●
G32-QCH-Q14-270C-ZJ200	32	30	270	200	Q10	0,8	●

Spare parts

	Thread	Q8 / Q10	Q12 / Q14	Q18
	Wrench	QCH-10x13	QCH-16x20	QCH-26

Indexable heads shanks

Steel shank, stepped, Q thread

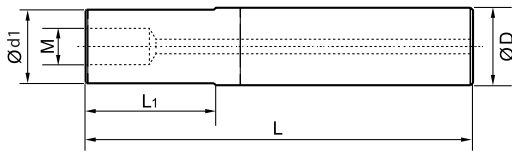

Article	Dimensions [mm]				Thread (M)	Stock
	D	d1	L	L1		
G12-QCH-Q08-65S	12	11,5	65	19	Q08	●
G16-QCH-Q10-100S	16	15,2	100	42	Q10	●
G20-QCH-Q12-110S	20	19	110	54	Q12	●

Solid carbide shank, stepped, metric thread

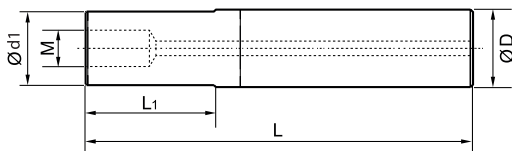

Article	Dimensions [mm]				Thread (M)	Stock
	D	d1	L	L1		
G16-QCH-M8-90C-125	16	12,5	90	35	M8	○
G16-QCH-M8-110C-125	16	12,5	110	55	M8	○
G16-QCH-M8-130C-125	16	12,5	130	75	M8	○
G16-QCH-M8-90C	16	15	90	35	M8	○
G16-QCH-M8-110C	16	15	110	55	M8	○
G16-QCH-M8-130C	16	15	130	75	M8	○
G16-QCH-M8-170C	16	15	170	115	M8	○
G16-QCH-M8-200C	16	15	200	145	M8	○
G20-QCH-M10-87C	20	18,5	87	30	M10	○
G20-QCH-M10-107C	20	18,5	107	50	M10	○
G20-QCH-M10-127C	20	18,5	127	70	M10	○
G20-QCH-M10-167C	20	18,5	167	110	M10	○
G20-QCH-M10-197C	20	18,5	197	140	M10	○
G25-QCH-M12-128C	25	23	128	65	M12	○
G25-QCH-M12-148C	25	23	148	85	M12	○
G25-QCH-M12-168C	25	23	168	105	M12	○
G25-QCH-M12-198C	25	23	198	135	M12	○
G25-QCH-M12-228C	25	23	228	165	M12	○
G32-QCH-M16-161C	32	29	161	95	M16	○
G32-QCH-M16-211C	32	29	211	145	M16	○
G32-QCH-M16-281C	32	29	281	215	M16	○
G32-QCH-M16-311C	32	29	311	245	M16	○
G32-QCH-M16-361C	32	29	361	295	M16	○

A

Turning

B

Milling

C

Drilling

D

Technical
Information

E

Index

Guide for recommended cutting data – solid carbide milling

End mill – GM series

1	Material group	Composition / structure / heat treatment	2 Brinell hardness HB	Machining group	Starting values for cutting speed v_c [m/min]								
					5501R302GM 5601R302GM 5502R302GM 5602R302GM				GM-2E GM-2EFP GM-2F				
					Slot milling		Shoulder milling		Slot milling		Shoulder milling		
					ϕ [mm]	$a_{p,max}$	ϕ [mm]	$a_{e,max}$	ϕ [mm]	$a_{p,max}$	ϕ [mm]	$a_{e,max}$	
					$0 < x < 3$	$0,1 \times D$	$0 < x \leq 20$	$< 0,5 \times D$	$0 < x < 3$	$0,1 \times D$	$0 < x \leq 20$	$< 0,5 \times D$	
					$3 \leq x \leq 20$	$0,8 \times D$			$3 \leq x \leq 20$	$0,8 \times D$			
					KMG303				KMG303				
					a_e / D				a_e / D				
						1/1	1/2	1/10	f-group	1/1	1/2	1/10	f-group
P	Unalloyed steel	ca. 0,15 % C	annealed	125	1	150	200	270	2	150	200	270	2
		ca. 0,45 % C	annealed	190	2	145	190	260	2	145	190	260	2
		ca. 0,45 % C	tempered	250	3	105	140	190	2	105	140	190	2
		ca. 0,75 % C	annealed	270	4	90	120	165	2	90	120	165	2
		ca. 0,75 % C	tempered	300	5	85	110	150	2	85	110	150	2
	Low-alloyed steel		annealed	180	6	115	150	205	2	115	150	205	2
			tempered	275	7	90	120	165	2	90	120	165	2
			tempered	300	8	85	110	150	2	85	110	150	2
			tempered	350	9	80	105	145	2	80	105	145	2
			tempered	300	8	85	110	150	2	85	110	150	2
High-alloyed steel and high-alloyed tool steel		annealed	200	10	105	140	190	2	105	140	190	2	
		hardened and tempered	325	11	80	110	145	2	80	110	145	2	
M	Stainless steel	ferritic/martensitic	annealed	200	12	50	65	90	2	50	65	90	2
		martensitic	tempered	240	13	45	60	80	2	45	60	80	2
		austenitic	quench hardened	180	14	55	70	95	2	55	70	95	2
		austenitic-ferritic		230	15	45	60	80	2	45	60	80	2
K	Grey cast iron	perlite/ferritic		180	16	110	150	200	2	110	150	200	2
		perlite (martensitic)		260	17	90	120	165	2	90	120	165	2
K	Cast iron with spheroidal graphite	ferritic		160	18	135	180	245	2	135	180	245	2
		perlite		250	15	105	140	190	2	105	140	190	2
		ferritic		130	20	150	200	270	2	150	200	270	2
K	Malleable cast iron	ferritic		130	20	150	200	270	2	150	200	270	2
		perlite		230	21	120	160	220	2	120	160	220	2
N	Aluminium wrought alloys	cannot be hardened		60	22								
		hardenable	hardened	100	23								
	Cast aluminium alloys	$\leq 12\% \text{ Si}$, cannot be hardened		75	24								
		$\leq 12\% \text{ Si}$, hardenable	hardened	90	25								
D	Copper and copper alloys (bronze/brass)	$> 12\% \text{ Si}$, cannot be hardened		130	26								
		machining steel, PB > 1%		110	27								
		CuZn, CuSnZn		90	28								
S	Heat-resistant alloys	Fe-based alloys	annealed	200	30								
			hardened	280	31								
			annealed	250	32								
		Ni or Co base	hardened	350	33								
			cast	320	34								
S	Titanium alloys	pure titanium		R_m 400	35								
		α and β alloys	hardened	R_m 1050	36								
H	Hardened steel		hardened and tempered	55 HRC	37								
			hardened and tempered	60 HRC	38								
			cast	400	35								
H	Hardened cast iron		hardened and tempered	55 HRC	40								
			hardened and tempered	60 HRC	38								
			cast	400	35								
E	Non-metallic materials	Thermoplasts			41								
		Thermosetting plastics				42							
		Plastic, glass-fibre reinforced GFRP				43							
		Plastic, carbon fibre reinforced CFRP				44							
		Graphite				45							
		Wood				46							

Note: The given cutting values are guide values, which were determined under ideal conditions.
 The values have to be adapted in individual cases.
 Feed rate recommendations on page B460
 For examples of material for cutting tool groups view page D22.

Recommend feed rate

Solid carbide milling group 2 – Square shoulder mills GM series

4 a_p/D	Feed rate per cutting edge (f_z) [mm]															
	Ø0,5	Ø0,8	Ø 1	Ø 2	Ø 3	Ø 4	Ø 5	Ø 6	Ø 8	Ø 10	Ø 12	Ø 14	Ø 16	Ø 18	Ø 20	
P	1/1	0,01	0,02	0,02	0,02	0,02	0,02	0,03	0,03	0,04	0,06	0,07	0,07	0,08	0,08	0,09
	1/2	0,01	0,03	0,03	0,03	0,03	0,03	0,04	0,04	0,05	0,08	0,09	0,09	0,10	0,10	0,12
M	1/10	0,02	0,04	0,04	0,04	0,04	0,04	0,06	0,06	0,08	0,12	0,14	0,14	0,16	0,16	0,18
	1/1	0,01	0,02	0,02	0,02	0,02	0,02	0,02	0,02	0,03	0,05	0,06	0,06	0,06	0,06	0,07
K	1/2	0,01	0,02	0,02	0,02	0,02	0,02	0,03	0,03	0,04	0,06	0,07	0,07	0,08	0,08	0,09
	1/10	0,02	0,03	0,03	0,03	0,03	0,03	0,05	0,05	0,06	0,10	0,11	0,11	0,13	0,13	0,15
5	1/1	0,01	0,02	0,02	0,02	0,02	0,02	0,03	0,03	0,04	0,06	0,07	0,07	0,08	0,08	0,09
	1/2	0,01	0,03	0,03	0,03	0,03	0,03	0,04	0,04	0,05	0,08	0,09	0,09	0,10	0,10	0,12
5	1/10	0,02	0,04	0,04	0,04	0,04	0,04	0,06	0,06	0,08	0,12	0,14	0,14	0,16	0,16	0,18

Note: The given cutting values are guide values, which were determined under ideal conditions. The values have to be adapted in individual cases.

1. Select the appropriate product series.
2. Determine the immersion.
3. Select the used material and read the cutting speed.
4. Determine the feed rate group and have a look at the appropriate feed rate recommendations.
5. Select the diameter of tool and determine the immersion.

A

Turning

B

Milling

C

Drilling

D

Technical Information

E

Index

End mill – GM series

Material group	Composition / structure / heat treatment	Brinell hardness HB	Machining group	Starting values for cutting speed v_c [m/min]									
				5501R302GM 5601R302GM 5502R302GM 5602R302GM					GM-2E GM-2EFP GM-2F				
				Slot milling		Shoulder milling			Slot milling		Shoulder milling		
				\emptyset [mm]	a_p max	\emptyset [mm]	a_e max	\emptyset [mm]	a_p max	\emptyset [mm]	a_e max		
				$0 < x < 3$	$0,1 \times D$	$0 < x \leq 20$	$< 0,5 \times D$	$0 < x < 3$	$0,1 \times D$	$0 < x \leq 20$	$< 0,5 \times D$		
				$3 \leq x \leq 20$	$0,8 \times D$			$3 \leq x \leq 20$	$0,8 \times D$				
KMG303					KMG303								
a_e / D					a_e / D								
1/1	1/2	1/10	f-group	1/1	1/2	1/10	f-group						
P Unalloyed steel	approx. 0,15 % C	annealed	125	1	150	200	270	2	150	200	270	2	
	approx. 0,45 % C	annealed	190	2	145	190	260	2	145	190	260	2	
	approx. 0,45 % C	tempered	250	3	105	140	190	2	105	140	190	2	
	approx. 0,75 % C	annealed	270	4	90	120	165	2	90	120	165	2	
	approx. 0,75 % C	tempered	300	5	85	110	150	2	85	110	150	2	
P Low-alloyed steel		annealed	180	6	115	150	205	2	115	150	205	2	
		tempered	275	7	90	120	165	2	90	120	165	2	
		tempered	300	8	85	110	150	2	85	110	150	2	
		tempered	350	9	80	105	145	2	80	105	145	2	
P High-alloyed steel and high-alloyed tool steel		annealed	200	10	105	140	190	2	105	140	190	2	
		hardened and tempered	325	11	80	110	145	2	80	110	145	2	
M Stainless steel	ferritic/martensitic	annealed	200	12	50	65	90	2	50	65	90	2	
	martensitic	tempered	240	13	45	60	80	2	45	60	80	2	
	austenitic	quench hardened	180	14	55	70	95	2	55	70	95	2	
	austenitic-ferritic		230	15	45	60	80	2	45	60	80	2	
K Grey cast iron	perlitic/ferritic		180	16	110	150	200	2	110	150	200	2	
	perlitic (martensitic)		260	17	90	120	165	2	90	120	165	2	
K Cast iron with spheroidal graphite	ferritic		160	18	135	180	245	2	135	180	245	2	
	perlitic		250	19	105	140	190	2	105	140	190	2	
K Malleable cast iron	ferritic		130	20	150	200	270	2	150	200	270	2	
	perlitic		230	21	120	160	220	2	120	160	220	2	
N Aluminium wrought alloys	cannot be hardened		60	22									
	hardenable	hardened	100	23									
	$\leq 12\% \text{ Si}$, cannot be hardened		75	24									
	$\leq 12\% \text{ Si}$, hardenable	hardened	90	25									
	$> 12\% \text{ Si}$, cannot be hardened		130	26									
N Cast aluminium alloys			110	27									
	Copper and copper alloys (bronze/brass)		90	28									
			100	29									
S Copper and copper alloys (bronze/brass)			110	27									
			90	28									
			100	29									
	S Heat-resistant alloys	Fe-based alloys	annealed	200	30								
			hardened	280	31								
		Ni or Co bass	annealed	250	32								
hardened			350	33									
S Titanium alloys	cast	320	34										
	pure titanium		R_m 400	35									
S α and β alloys	hardened		R_m 1050	36									
H Hardened steel		hardened and tempered	55 HRC	37									
		hardened and tempered	60 HRC	38									
H Hard cast iron		cast	400	39									
H Hardened cast iron		hardened and tempered	55 HRC	40									
X Non-metallic materials		Thermoplasts		41									
		Thermosetting plastics		42									
		Plastic, glass-fibre reinforced GFRP		43									
		Plastic, carbon fibre reinforced CFRP		44									
		Graphite		45									
		Wood		46									

Note: The given cutting values are guide values, which were determined under ideal conditions.
The values have to be adapted in individual cases.
Feed rate recommendations on page B522.
For examples of material for cutting tool groups view page D11.

End mill – GM series

Material group	Composition / structure / heat treatment	Brinell hardness HB	Machining group	Starting values for cutting speed v_c [m/min]										
				GM-2BL GM-4BL GM-2BFP					GM-2R GM-4R					
									Slot milling		Shoulder milling			
									\varnothing [mm]	$a_{p\max}$	\varnothing [mm]	$a_{e\max}$		
					$0 < x < 3$	$0,1 \times D$	$0 < x \leq 20$	$< 0,5 \times D$						
					$3 \leq x \leq 20$	$0,8 \times D$								
					KMG303					KMG303				
					a_e / D					a_e / D				
					1/1	1/10	1/20	f-group	1/1	1/2	1/10	f-group		
P Unalloyed steel	approx. 0,15 % C	annealed	125	1	–	220	250	5	160	215	275	2		
	approx. 0,45 % C	annealed	190	2	–	210	240	5	155	205	265	2		
	approx. 0,45 % C	tempered	250	3	–	155	175	5	115	155	195	2		
	approx. 0,75 % C	annealed	270	4	–	135	150	5	100	130	165	2		
	approx. 0,75 % C	tempered	300	5	–	125	140	5	90	120	155	2		
P Low-alloyed steel		annealed	180	6	–	165	190	5	120	165	210	2		
		tempered	275	7	–	135	150	5	100	130	165	2		
		tempered	300	8	–	125	140	5	90	120	155	2		
		tempered	350	9	–	115	130	5	85	115	145	2		
P High-alloyed steel and high-alloyed tool steel		annealed	200	10	–	155	175	5	115	155	195	2		
		hardened and tempered	325	11	–	120	135	5	85	115	150	2		
M Stainless steel	ferritic/martensitic	annealed	200	12	–	75	80	5	55	70	90	2		
	martensitic	tempered	240	13	–	65	70	5	45	65	80	2		
	austenitic	quench hardened	180	14	–	75	85	5	55	75	95	2		
	austenitic-ferritic		230	15	–	65	70	5	45	65	80	2		
K Grey cast iron	perlitic/ferritic		180	16	–	165	185	5	120	160	205	2		
	perlitic (martensitic)		260	17	–	135	150	5	100	130	165	2		
K Cast iron with spheroidal graphite	ferritic		160	18	–	200	225	5	145	195	250	2		
	perlitic		250	19	–	155	175	5	115	155	195	2		
K Malleable cast iron	ferritic		130	20	–	220	250	5	160	215	275	2		
	perlitic		230	21	–	180	200	5	130	175	220	2		
N Aluminium wrought alloys	cannot be hardened		60	22										
	hardenable	hardened	100	23										
	$\leq 12\% \text{ Si}$, cannot be hardened		75	24										
	$\leq 12\% \text{ Si}$, hardenable	hardened	90	25										
N Cast aluminium alloys	$> 12\% \text{ Si}$, cannot be hardened		130	26										
	machining steel, PB> 1%		110	27										
	CuZn, CuSnZn		90	28										
S Copper and copper alloys (bronze/brass)	CuSn, Pb-free copper, electrolytic copper		100	29										
	Heat-resistant alloys	Fe-based alloys	annealed	200	30									
		hardened	280	31										
	Ni or Co bass	annealed	250	32										
hardened		350	33											
Titanium alloys	cast	320	34											
	pure titanium		R_m 400	35										
H Hardened steel	α and β alloys	hardened	R_m 1050	36										
	hardened and tempered	55 HRC		37										
H Hard cast iron	hardened and tempered	60 HRC		38										
	cast	400		39										
H Hardened cast iron	hardened and tempered	55 HRC		40										
	Thermoplasts			41										
X Non-metallic materials	Thermosetting plastics			42										
	Plastic, glass-fibre reinforced GFRP			43										
	Plastic, carbon fibre reinforced CFRP			44										
	Graphite			45										
	Wood			46										

Note: The given cutting values are guide values, which were determined under ideal conditions.
 The values have to be adapted in individual cases.
 Feed rate recommendations on page B522.
 For examples of material for cutting tool groups view page D11.

End mill – HM series

Material group	Composition / structure / heat treatment	Brinell hardness HB	Machining group	Starting values for cutting speed v_c [m/min]									
				HM-2E HM-2EP HM-2ES HM-4E					HM-2EFP HM-4EL HM-4EFP				
				Shoulder milling		Shoulder milling		Shoulder milling		Shoulder milling			
				\varnothing [mm]	a_e max	\varnothing [mm]	a_e max	\varnothing [mm]	a_e max	\varnothing [mm]	a_e max		
$0 < x \leq 20$		$0,05 \times D$		$0 < x \leq 20$		$0,05 \times D$		$0 < x \leq 20$		$0,05 \times D$			
KMG555					KMG555								
a_e / D		a_e / D		a_e / D		a_e / D		a_e / D		a_e / D			
1/1	1/2	1/10	f-group	1/1	1/2	1/10	f-group	1/1	1/2	1/10	f-group		
P Unalloyed steel	approx. 0,15 % C	annealed	125	1									
	approx. 0,45 % C	annealed	190	2									
	approx. 0,45 % C	tempered	250	3									
	approx. 0,75 % C	annealed	270	4									
	approx. 0,75 % C	tempered	300	5									
P Low-alloyed steel		annealed	180	6									
		tempered	275	7									
		tempered	300	8									
		tempered	350	9									
High-alloyed steel and high-alloyed tool steel		annealed	200	10									
		hardened and tempered	325	11									
M Stainless steel	ferritic/martensitic	annealed	200	12									
	martensitic	tempered	240	13									
	austenitic	quench hardened	180	14									
	austenitic-ferritic		230	15									
K Grey cast iron	perlitic/ferritic		180	16									
	perlitic (martensitic)		260	17									
K Cast iron with spheroidal graphite	ferritic		160	18									
	perlitic		250	19									
Malleable cast iron	ferritic		130	20									
	perlitic		230	21									
N Aluminium wrought alloys	cannot be hardened		60	22									
	hardenable	hardened	100	23									
	$\leq 12\% \text{ Si}$, cannot be hardened		75	24									
	$\leq 12\% \text{ Si}$, hardenable	hardened	90	25									
N Cast aluminium alloys	$> 12\% \text{ Si}$, cannot be hardened		130	26									
	machining steel, PB> 1%		110	27									
	CuZn, CuSnZn		90	28									
Copper and copper alloys (bronze/brass)	CuSn, Pb-free copper, electrolytic copper		100	29									
	S Heat-resistant alloys	Fe-based alloys	annealed	200	30								
hardened			280	31									
Ni or Co bass		annealed	250	32									
		hardened	350	33									
Titanium alloys	cast	320	34										
	pure titanium		R_m 400	35									
	α and β alloys	hardened	R_m 1050	36									
H Hardened steel		hardened and tempered	55 HRC	37	55	100	125	3	50	95	115	3	
		hardened and tempered	60 HRC	38	55	95	120	3	50	95	110	3	
H Hard cast iron		cast	400	39	70	125	160	3	65	120	145	3	
H Hardened cast iron		hardened and tempered	55 HRC	40	55	100	125	3	50	95	115	3	
X Non-metallic materials	Thermoplasts			41									
	Thermosetting plastics			42									
	Plastic, glass-fibre reinforced GFRP			43									
	Plastic, carbon fibre reinforced CFRP			44									
	Graphite			45									
	Wood			46									

Note: The given cutting values are guide values, which were determined under ideal conditions.
 The values have to be adapted in individual cases.
 Feed rate recommendations on page B522.
 For examples of material for cutting tool groups view page D11.

End mill – NM series

Material group	Composition / structure / heat treatment	Brinell hardness HB	Machining group	Starting values for cutting speed v_c [m/min]								
				5502R402NM NM-2E NM-4E NM-2EP				NM-2B NM-4BP				
				Slot milling		Shoulder milling						
				\varnothing [mm]	a_p max	\varnothing [mm]	a_e max					
	$0 < x < 12$	$0.5 \times D$	$0 < x \leq 20$	$< 0.5 \times D$								
	$12 \leq x \leq 20$	$1.0 \times D$										
				KMG309				KMG309				
				a_e / D		a_e / D		a_e / D		a_e / D		
				1/1	1/2	1/10	f-group	1/1	1/10	1/20	f-group	
P Unalloyed steel	approx. 0,15 % C	annealed	125	1								
	approx. 0,45 % C	annealed	190	2								
	approx. 0,45 % C	tempered	250	3								
	approx. 0,75 % C	annealed	270	4								
	approx. 0,75 % C	tempered	300	5								
P Low-alloyed steel		annealed	180	6								
		tempered	275	7								
		tempered	300	8								
		tempered	350	9								
High-alloyed steel and high-alloyed tool steel		annealed	200	10								
		hardened and tempered	325	11								
M Stainless steel	ferritic/martensitic	annealed	200	12								
		tempered	240	13								
	austenitic	quench hardened	180	14								
			230	15								
K Grey cast iron	perlitic/ferritic		180	16								
	perlitic (martensitic)		260	17								
K Cast iron with spheroidal graphite	ferritic		160	18								
	perlitic		250	19								
K Malleable cast iron	ferritic		130	20								
	perlitic		230	21								
N Aluminium wrought alloys	cannot be hardened		60	22	920	1100	1200	4	–	1400	1550	4
	hardenable	hardened	100	23	555	660	720	4	–	840	930	4
	$\leq 12\% \text{ Si}$, cannot be hardened		75	24	370	440	480	4	–	560	620	4
	$\leq 12\% \text{ Si}$, hardenable	hardened	90	25	460	550	600	4	–	700	775	4
	$> 12\% \text{ Si}$, cannot be hardened		130	26	140	165	180	4	–	210	235	4
N Cast aluminium alloys			110	27	280	330	360	4	–	420	465	4
			90	28	325	385	420	4	–	490	545	4
			100	29	280	330	360	4	–	420	465	4
D Copper and copper alloys (bronze/brass)	machining steel, PB> 1%		110	27	280	330	360	4	–	420	465	4
	CuZn, CuSnZn		90	28	325	385	420	4	–	490	545	4
	CuSn, Pb-free copper, electrolytic copper		100	29	280	330	360	4	–	420	465	4
S Heat-resistant alloys	Fe-based alloys	annealed	200	30								
		hardened	280	31								
	Ni or Co bass	annealed	250	32								
		hardened	350	33								
		cast	320	34								
Titanium alloys	pure titanium		R_m 400	35								
	α and β alloys	hardened	R_m 1050	36								
H Hardened steel		hardened and tempered	55 HRC	37								
		hardened and tempered	60 HRC	38								
H Hard cast iron		cast	400	39								
H Hardened cast iron		hardened and tempered	55 HRC	40								
X Non-metallic materials	Thermoplasts			41								
	Thermosetting plastics			42								
	Plastic, glass-fibre reinforced GFRP			43								
	Plastic, carbon fibre reinforced CFRP			44								
	Graphite			45								
	Wood			46								

Note: The given cutting values are guide values, which were determined under ideal conditions.
The values have to be adapted in individual cases.
Feed rate recommendations on page B522.
For examples of material for cutting tool groups view page D11.

End mill – AL series, ALP/ALG series

Material group	Composition / structure / heat treatment	Brinell hardness HB	Machining group	Starting values for cutting speed v_c [m/min]								
				ALP-1EP				AL-1E AL-2E AL-3E (W) ALG-2E				
				Slot milling		Shoulder milling		Slot milling		Shoulder milling		
				\varnothing [mm]	a_p max	\varnothing [mm]	a_e max	\varnothing [mm]	a_p max	\varnothing [mm]	a_e max	
				$0 < x < 12$	$0.5 \times D$	$0 < x \leq 20$	$< 0.5 \times D$	$0 < x < 12$	$0.5 \times D$	$0 < x \leq 20$	$< 0.5 \times D$	
				YK40F / KMD401				YK30F / YK40F				
				a_e / D				a_e / D				
				1/1	1/2	1/10	f-group	1/1	1/2	1/10	f-group	
P Unalloyed steel	approx. 0,15 % C	annealed	125	1								
	approx. 0,45 % C	annealed	190	2								
	approx. 0,45 % C	tempered	250	3								
	approx. 0,75 % C	annealed	270	4								
	approx. 0,75 % C	tempered	300	5								
Low-alloyed steel		annealed	180	6								
		tempered	275	7								
		tempered	300	8								
		tempered	350	9								
High-alloyed steel and high-alloyed tool steel		annealed	200	10								
		hardened and tempered	325	11								
M Stainless steel	ferritic/martensitic	annealed	200	12								
		tempered	240	13								
	austenitic	quench hardened	180	14								
			230	15								
Grey cast iron	perlitic/ferritic		180	16								
	perlitic (martensitic)		260	17								
Cast iron with spheroidal graphite	ferritic		160	18								
	perlitic		250	19								
Malleable cast iron	ferritic		130	20								
	perlitic		230	21								
N Aluminium wrought alloys	cannot be hardened		60	22	300	345	375	12	920	1100	1200	4
	hardenable	hardened	100	23	250	290	315	12	555	660	720	4
	$\leq 12\% \text{ Si}$, cannot be hardened		75	24	250	280	315	12	370	440	480	4
	$\leq 12\% \text{ Si}$, hardenable	hardened	90	25	210	240	265	12	460	550	600	4
	$> 12\% \text{ Si}$, cannot be hardened		130	26	180	210	225	12	140	165	180	4
Copper and copper alloys (bronze/brass)	machining steel, PB > 1%		110	27	280	320	350	12	280	330	360	4
	CuZn, CuSnZn		90	28	310	360	390	12	325	385	420	4
	CuSn, Pb-free copper, electrolytic copper		100	29	280	320	350	12	280	330	360	4
S Heat-resistant alloys	Fe-based alloys	annealed	200	30								
		hardened	280	31								
	Ni or Co bass	annealed	250	32								
		hardened	350	33								
		cast	320	34								
Titanium alloys	pure titanium		$R_m 400$	35								
	α and β alloys	hardened	$R_m 1050$	36								
H Hardened steel		hardened and tempered	55 HRC	37								
		hardened and tempered	60 HRC	38								
Hard cast iron		cast	400	39								
Hardened cast iron		hardened and tempered	55 HRC	40								
X Non-metallic materials	Thermoplasts			41								
	Thermosetting plastics			42								
	Plastic, glass-fibre reinforced GFRP			43								
	Plastic, carbon fibre reinforced CFRP			44								
	Graphite			45								
	Wood			46								

Note: The given cutting values are guide values, which were determined under ideal conditions. The values have to be adapted in individual cases. Feed rate recommendations on page B522. For examples of material for cutting tool groups view page D11.

End mill – AL series, ALP/ALG series

Material group	Composition / structure / heat treatment	Brinell hardness HB	Machining group	Starting values for cutting speed v_c [m/min]									
				ALG-2R (W)				AL-2RL-AIR AL-3RL-AIR					
				Slot milling		Shoulder milling		Slot milling		Shoulder milling			
				\varnothing [mm]	a_p max	\varnothing [mm]	a_e max	\varnothing [mm]	a_p max	\varnothing [mm]	a_e max		
				0<x<12	0.5xD	0<x≤20	<0.5xD	0<x<12	0.5xD	0<x≤20	<0.5xD		
				12≤x≤20	1,0xD			12≤x≤20	1,0xD				
				KMD401				YK40F					
				a_e / D				a_e / D					
				1/1	1/2	1/10	f-group	1/1	1/2	1/10	f-group		
P Unalloyed steel	approx. 0,15 % C	annealed	125	1									
	approx. 0,45 % C	annealed	190	2									
	approx. 0,45 % C	tempered	250	3									
	approx. 0,75 % C	annealed	270	4									
	approx. 0,75 % C	tempered	300	5									
Low-alloyed steel		annealed	180	6									
		tempered	275	7									
		tempered	300	8									
		tempered	350	9									
High-alloyed steel and high-alloyed tool steel		annealed	200	10									
		hardened and tempered	325	11									
M Stainless steel	ferritic/martensitic	annealed	200	12									
	martensitic	tempered	240	13									
	austenitic	quench hardened	180	14									
	austenitic-ferritic		230	15									
Grey cast iron	perlitic/ferritic		180	16									
	perlitic (martensitic)		260	17									
Cast iron with spheroidal graphite	ferritic		160	18									
	perlitic		250	19									
Malleable cast iron	ferritic		130	20									
	perlitic		230	21									
N Aluminium wrought alloys	cannot be hardened		60	22	1495	1795	1950	8	1035	1250	1350	8	
	hardenable	hardened	100	23	900	1080	1170	8	625	750	810	8	
	≤ 12 % Si, cannot be hardened		75	24	600	725	780	8	415	500	540	8	
	≤ 12 % Si, hardenable	hardened	90	25	750	900	975	8	520	625	675	8	
	> 12 % Si, cannot be hardened		130	26	230	275	295	8	160	190	205	8	
Copper and copper alloys (bronze/brass)	machining steel, PB> 1%		110	27	450	540	585	8	315	375	405	8	
	CuZn, CuSnZn		90	28	530	635	685	8	365	440	475	8	
	CuSn, Pb-free copper, electrolytic copper		100	29	450	540	585	8	315	375	405	8	
S Heat-resistant alloys	Fe-based alloys	annealed	200	30									
		hardened	280	31									
	Ni or Co bass	annealed	250	32									
		hardened	350	33									
		cast	320	34									
Titanium alloys	pure titanium		R _m 400	35									
	α and β alloys	hardened	R _m 1050	36									
H Hardened steel		hardened and tempered	55 HRC	37									
		hardened and tempered	60 HRC	38									
Hard cast iron		cast	400	39									
		hardened and tempered	55 HRC	40									
X Non-metallic materials	Thermoplasts			41									
	Thermosetting plastics			42									
	Plastic, glass-fibre reinforced GFRP			43									
	Plastic, carbon fibre reinforced CFRP			44									
	Graphite			45									
	Wood			46									

Note: The given cutting values are guide values, which were determined under ideal conditions.
The values have to be adapted in individual cases.
Feed rate recommendations on page B522.
For examples of material for cutting tool groups view page D11.

End mill – TM series

Material group	Composition / structure / heat treatment	Brinell hardness HB	Machining group	Starting values for cutting speed v_c [m/min]									
				TM-4R / TM-4RP TM-5R / TM-5RP TM-7R / TM-7RP TM-9R / TM-9RP				TM-4B / TM-4BP TM-5B / TM-5BP					
				Slot milling		Shoulder milling							
				\varnothing [mm]	$a_{p\max}$	\varnothing [mm]	$a_{e\max}$						
				$0 < x < 3$	$0,3 \times D$	$0 < x < 3$	$0,3 \times D$						
P Unalloyed steel Low-alloyed steel High-alloyed steel and high-alloyed tool steel	approx. 0,15 % C	annealed	125	1									
	approx. 0,45 % C	annealed	190	2									
	approx. 0,45 % C	tempered	250	3									
	approx. 0,75 % C	annealed	270	4									
	approx. 0,75 % C	tempered	300	5									
		annealed	180	6									
		tempered	275	7									
		tempered	300	8									
		tempered	350	9									
		annealed	200	10									
		hardened and tempered	325	11									
M Stainless steel	ferritic/martensitic	annealed	200	12									
	martensitic	tempered	240	13									
	austenitic	quench hardened	180	14									
	austenitic-ferritic		230	15									
K Grey cast iron Cast iron with spheroidal graphite Malleable cast iron	perlitic/ferritic		180	16									
	perlitic (martensitic)		260	17									
	ferritic		160	18									
	perlitic		250	19									
	ferritic		130	20									
	perlitic		230	21									
N Aluminium wrought alloys Cast aluminium alloys Copper and copper alloys (bronze/brass)	cannot be hardened		60	22									
	hardenable	hardened	100	23									
	$\leq 12\% \text{ Si}$, cannot be hardened		75	24									
	$\leq 12\% \text{ Si}$, hardenable	hardened	90	25									
	$> 12\% \text{ Si}$, cannot be hardened		130	26									
	machining steel, PB> 1%		110	27									
S Heat-resistant alloys Titanium alloys	CuZn, CuSnZn		90	28									
	CuSn, Pb-free copper, electrolytic copper		100	29									
	Fe-based alloys	annealed	200	30	45	55	85	10	–	85	90	10	
		hardened	280	31	25	30	45	10	–	45	50	10	
		Ni or Co bass	annealed	250	32	45	55	85	10	–	85	90	10
			hardened	350	33	25	30	45	10	–	45	50	10
	cast	320	34	25	30	45	10	–	45	50	10		
pure titanium		R_m 400	35	75	90	135	10	–	135	145	10		
	α and β alloys	hardened	R_m 1050	36	45	55	85	10	–	85	90	10	
H Hardened steel Hard cast iron Hardened cast iron	hardened and tempered	55 HRC	37										
	hardened and tempered	60 HRC	38										
	cast	400	39										
	hardened and tempered	55 HRC	40										
X Non-metallic materials	Thermoplasts			41									
	Thermosetting plastics			42									
	Plastic, glass-fibre reinforced GFRP			43									
	Plastic, carbon fibre reinforced CFRP			44									
	Graphite			45									
	Wood			46									

Note: The given cutting values are guide values, which were determined under ideal conditions.
The values have to be adapted in individual cases.
Feed rate recommendations on page B522.
For examples of material for cutting tool groups view page D11.

End mill – PM series

	Material group	Composition / structure / heat treatment	Brinell hardness HB	Machining group	Starting values for cutting speed v_c [m/min]									
					PM-2E PM-2ES / PM-2EP / PM-2RP PM-4E PM-4E-G				PM-4EL PM-4EL-G PM-4EX-G					
					Slot milling		Shoulder milling		Slot milling		Shoulder milling			
					\emptyset [mm]	$a_{p\max}$	\emptyset [mm]	$a_{e\max}$	\emptyset [mm]	$a_{p\max}$	\emptyset [mm]	$a_{e\max}$		
					$0 < x < 3$	$0,15 \times D$	$0 < x \leq 20$	$0,15 \times D$	$0 < x < 3$	$0,15 \times D$	$0 < x \leq 20$	$0,15 \times D$		
					$3 \leq x < 6$	$0,3 \times D$			$3 \leq x < 6$	$0,3 \times D$				
					$6 \leq x \leq 20$	$0,5 \times D$			$6 \leq x \leq 20$	$0,5 \times D$				
					KMG405				KMG405					
					a_e / D				a_e / D					
					1/1	1/2	1/10	f-group	1/1	1/2	1/10	f-group		
A Turning	P Unalloyed steel	approx. 0,15 % C	annealed	125	1	165	220	300	1	140	190	255	1	
		approx. 0,45 % C	annealed	190	2	160	210	285	1	135	185	245	1	
		approx. 0,45 % C	tempered	250	3	120	155	210	1	100	135	180	1	
		approx. 0,75 % C	annealed	270	4	100	135	180	1	85	115	155	1	
		approx. 0,75 % C	tempered	300	5	95	125	165	1	80	105	145	1	
		Low-alloyed steel	annealed	180	6	125	165	225	1	110	145	195	1	
			tempered	275	7	100	135	180	1	85	115	155	1	
			tempered	300	8	95	125	165	1	80	105	145	1	
			tempered	350	9	90	115	160	1	75	100	135	1	
		High-alloyed steel and high-alloyed tool steel	annealed	200	10	120	155	210	1	100	135	180	1	
hardened and tempered	325		11	90	120	160	1	75	105	140	1			
C Milling	M Stainless steel	ferritic/martensitic	annealed	200	12	55	75	100	1	45	65	85	1	
		martensitic	tempered	240	13	50	65	85	1	40	55	75	1	
		austenitic	quench hardened	180	14	60	75	105	1	50	65	90	1	
		austenitic-ferritic		230	15	50	65	85	1	40	55	75	1	
C Drilling	K Grey cast iron	perlite/ferritic		180	16	125	165	220	1	105	140	190	1	
		perlite (martensitic)		260	17	100	135	180	1	85	115	155	1	
	Cast iron with spheroidal graphite	ferritic		160	18	150	200	270	1	130	175	230	1	
		perlite		250	19	120	155	210	1	100	135	180	1	
	Malleable cast iron	ferritic		130	20	165	220	300	1	145	190	255	1	
		perlite		230	21	135	180	240	1	115	155	205	1	
D Technical Information	N Aluminium wrought alloys	cannot be hardened		60	22									
		hardenable	hardened	100	23									
		$\leq 12\% \text{ Si}$, cannot be hardened		75	24									
		Cast aluminium alloys	$\leq 12\% \text{ Si}$, hardenable	hardened	90	25								
			$> 12\% \text{ Si}$, cannot be hardened		130	26								
		Copper and copper alloys (bronze/brass)	machining steel, PB > 1%		110	27								
CuZn, CuSnZn			90	28										
CuSn, Pb-free copper, electrolytic copper			100	29										
E Index	X Non-metallic materials	Heat-resistant alloys	Fe-based alloys	annealed	200	30								
			hardened	280	31									
			Ni or Co bass	annealed	250	32								
				hardened	350	33								
		Titanium alloys	cast	320	34									
			pure titanium		$R_m 400$	35								
H Hardened steel	Hard cast iron	Hardened steel	hardened and tempered	55 HRC	37	80	105	140	1	65	90	120	1	
			hardened and tempered	60 HRC	38	-	-	-	-	-	-	-		
		Hard cast iron	cast	400	39	105	140	185	1	85	120	160	1	
		Hardened cast iron	hardened and tempered	55 HRC	40	-	-	-	-	-	-	-	-	
X Non-metallic materials	Thermoplasts			41										
	Thermosetting plastics			42										
	Plastic, glass-fibre reinforced GFRP			43										
	Plastic, carbon fibre reinforced CFRP			44										
	Graphite			45										
	Wood			46										

Note: The given cutting values are guide values, which were determined under ideal conditions.
The values have to be adapted in individual cases.
Feed rate recommendations on page B522.
For examples of material for cutting tool groups view page D11.

Starting values for cutting speed v_c [m/min]																					
PM-6E				PM-6EL				PM-2B PM-2BS / PM-2BP PM-4B				PM-2BL PM-2BFP PM-4BL				PM-2BC					
		Shoulder milling				Shoulder milling															
		\varnothing [mm]	$a_{p \max}$			\varnothing [mm]	$a_{p \max}$														
		$0 < x \leq 20$	$0.15 \times D$			$0 < x \leq 20$	$0.15 \times D$														
KMG405				KMG405				KMG405				KMG405				KMG405					
a_e / D				a_e / D				a_e / D				a_e / D				a_e / D					
1/1	1/2	1/10	f-group	1/1	1/2	1/10	f-group	1/1	1/10	1/20	f-group	1/1	1/10	1/20	f-group	1/1	1/10	1/20	f-group		
-	220	300	1	-	190	255	1	-	270	300	5	-	230	255	5	-	230	255	5		
-	210	285	1	-	185	245	1	-	260	285	5	-	220	245	5	-	220	245	5		
-	155	210	1	-	135	180	1	-	190	210	5	-	165	180	5	-	165	180	5		
-	135	180	1	-	115	155	1	-	165	180	5	-	140	155	5	-	140	155	5		
-	125	165	1	-	105	145	1	-	150	165	5	-	130	145	5	-	130	145	5		
-	165	225	1	-	145	195	1	-	205	225	5	-	175	195	5	-	175	195	5		
-	135	180	1	-	115	155	1	-	165	180	5	-	140	155	5	-	140	155	5		
-	125	165	1	-	105	145	1	-	150	165	5	-	130	145	5	-	130	145	5		
-	115	160	1	-	100	135	1	-	145	160	5	-	120	135	5	-	120	135	5		
-	155	210	1	-	135	180	1	-	190	210	5	-	165	180	5	-	165	180	5		
-	120	160	1	-	105	140	1	-	145	160	5	-	125	140	5	-	125	140	5		
-	75	100	1	-	65	85	1	-	90	100	5	-	75	85	5	-	75	85	5		
-	65	85	1	-	55	75	1	-	80	85	5	-	65	75	5	-	65	75	5		
-	75	105	1	-	65	90	1	-	95	105	5	-	80	90	5	-	80	90	5		
-	65	85	1	-	55	75	1	-	80	85	5	-	65	75	5	-	65	75	5		
-	165	220	1	-	140	190	1	-	200	220	5	-	170	190	5	-	170	190	5		
-	135	180	1	-	115	155	1	-	165	180	5	-	140	155	5	-	140	155	5		
-	200	270	1	-	175	230	1	-	245	270	5	-	210	230	5	-	210	230	5		
-	155	210	1	-	135	180	1	-	190	210	5	-	165	180	5	-	165	180	5		
-	220	300	1	-	190	255	1	-	270	300	5	-	230	255	5	-	230	255	5		
-	180	240	1	-	155	205	1	-	220	240	5	-	185	205	5	-	185	205	5		
-	105	140	1	-	90	120	1	-	125	140	5	-	110	120	5	-	110	120	5		
-	-	-	-	-	-	-	-	-	-	-	-	-	-	-	-	-	-	-	-		
-	140	185	1	-	120	160	1	-	165	185	1	-	145	160	1	-	145	160	1		
-	-	-	-	-	-	-	-	-	-	-	-	-	-	-	-	-	-	-	-		

A

Turning

B

Milling

C

Drilling

D

Technical Information

E

Index

End mill – PM series, VPM series

Material group	Composition / structure / heat treatment	Brinell hardness HB	Machining group	Starting values for cutting speed v_c [m/min]									
				PM-2R PM-4R				PM-4RL					
				Slot milling		Shoulder milling		Slot milling		Shoulder milling			
				\varnothing [mm]	a_p max	\varnothing [mm]	a_e max	\varnothing [mm]	a_p max	\varnothing [mm]	a_e max		
				$0 < x < 3$	$0,15 \times D$	$0 < x \leq 20$	$0,15 \times D$	$0 < x < 3$	$0,15 \times D$	$0 < x \leq 20$	$0,15 \times D$		
$3 \leq x < 6$	$0,3 \times D$			$3 \leq x < 6$	$0,3 \times D$								
$6 \leq x \leq 20$	$0,5 \times D$			$6 \leq x \leq 20$	$0,5 \times D$								
KMG405				KMG405									
a_e / D		a_e / D		a_e / D		a_e / D							
1/1	1/2	1/10	f-group	1/1	1/2	1/10	f-group						
P	Unalloyed steel	approx. 0,15 % C	annealed	125	1	165	220	300	1	150	200	265	1
		approx. 0,45 % C	annealed	190	2	160	210	285	1	145	190	255	1
		approx. 0,45 % C	tempered	250	3	120	155	210	1	105	140	190	1
		approx. 0,75 % C	annealed	270	4	100	135	180	1	90	120	160	1
		approx. 0,75 % C	tempered	300	5	95	125	165	1	85	110	150	1
	Low-alloyed steel		annealed	180	6	125	165	225	1	115	150	200	1
			tempered	275	7	100	135	180	1	90	120	160	1
			tempered	300	8	95	125	165	1	85	110	150	1
			tempered	350	9	90	115	160	1	80	105	140	1
	High-alloyed steel and high-alloyed tool steel		annealed	200	10	120	155	210	1	105	140	190	1
		hardened and tempered	325	11	90	120	160	1	80	110	145	1	
M	Stainless steel	ferritic/martensitic	annealed	200	12	55	75	100	1	50	65	85	1
		martensitic	tempered	240	13	50	65	85	1	45	60	75	1
		austenitic	quench hardened	180	14	60	75	105	1	55	70	95	1
		austenitic-ferritic		230	15	50	65	85	1	45	60	75	1
K	Grey cast iron	perlitic/ferritic		180	16	125	165	220	1	110	150	195	1
		perlitic (martensitic)		260	17	100	135	180	1	90	120	160	1
	Cast iron with spheroidal graphite	ferritic		160	18	150	200	270	1	135	180	240	1
		perlitic		250	19	120	155	210	1	105	140	190	1
	Malleable cast iron	ferritic		130	20	165	220	300	1	150	200	265	1
		perlitic		230	21	135	180	240	1	120	160	215	1
N	Aluminium wrought alloys	cannot be hardened		60	22								
		hardenable	hardened	100	23								
	Cast aluminium alloys	$\leq 12\%$ Si, cannot be hardened		75	24								
		$\leq 12\%$ Si, hardenable	hardened	90	25								
		$> 12\%$ Si, cannot be hardened		130	26								
	Copper and copper alloys (bronze/brass)	machining steel, PB> 1%			110	27							
		CuZn, CuSnZn			90	28							
CuSn, Pb-free copper, electrolytic copper			100	29									
S	Heat-resistant alloys	Fe-based alloys	annealed	200	30								
			hardened	280	31								
		Ni or Co bass	annealed	250	32								
			hardened	350	33								
	Titanium alloys	cast	320	34									
		pure titanium		R_m 400	35								
α and β alloys	hardened	R_m 1050	36										
H	Hardened steel	hardened and tempered	55 HRC	37	85	110	145	1	70	95	125	1	
		hardened and tempered	60 HRC	38	-	-	-	-	-	-	-	-	
	Hard cast iron	cast	400	39	115	145	190	1	95	125	165	1	
	Hardened cast iron	hardened and tempered	55 HRC	40	-	-	-	-	-	-	-	-	
X	Non-metallic materials	Thermoplasts			41								
		Thermosetting plastics			42								
		Plastic, glass-fibre reinforced GFRP			43								
		Plastic, carbon fibre reinforced CFRP			44								
		Graphite			45								
		Wood			46								

Note: The given cutting values are guide values, which were determined under ideal conditions.
 The values have to be adapted in individual cases.
 Feed rate recommendations on page B522.
 For examples of material for cutting tool groups view page D11.

End mill – HPC series, UM/UMC series, VSM series

Material group	Composition / structure / heat treatment	Brinell hardness HB	Machining group	Starting values for cutting speed v_c [m/min]									
				5501R38414GM (-R) 5502R38414GM (-R) 5602R38414GM (-R)					5501R38414GM 5502R38414GM 5602R38414GM				
				Slot milling		Shoulder milling			Slot milling		Shoulder milling		
				\varnothing [mm]	$a_{p\max}$	\varnothing [mm]	$a_{e\max}$	f [mm]	\varnothing [mm]	$a_{p\max}$	\varnothing [mm]	$a_{e\max}$	f [mm]
				$0 < x < 3$	$0,3 \times D$	$0 < x < 3$	$0,15 \times D$	$0 < x < 3$	$0,3 \times D$	$0 < x < 3$	$0,15 \times D$	$3 \leq x < 12$	$0,7 \times D$
P Unalloyed steel	approx. 0,15 % C	annealed	125	1	250	300	380	9	230	280	350	9	
	approx. 0,45 % C	annealed	190	2	240	285	365	9	220	270	340	9	
	approx. 0,45 % C	tempered	250	3	175	210	270	9	160	190	250	9	
	approx. 0,75 % C	annealed	270	4	150	180	230	9	140	160	210	9	
	approx. 0,75 % C	tempered	300	5	140	165	210	9	130	150	200	9	
	Low-alloyed steel		annealed	180	6	190	225	285	9	180	215	270	9
			tempered	275	7	150	180	230	9	130	170	220	9
			tempered	300	8	140	165	210	9	125	150	190	9
			tempered	350	9	130	160	200	9	120	150	190	9
	High-alloyed steel and high-alloyed tool steel		annealed	200	10	175	210	270	9	160	190	250	9
		hardened and tempered	325	11	135	160	205	9	115	140	190	9	
M Stainless steel	ferritic/martensitic	annealed	200	12	80	100	125	9	70	90	110	9	
	martensitic	tempered	240	13	70	85	110	9	60	80	100	9	
	austenitic	quench hardened	180	14	85	105	130	9	75	90	120	9	
	austenitic-ferritic		230	15	70	85	110	9	65	80	100	9	
K Grey cast iron	perlitic/ferritic		180	16	185	220	280	9	160	200	260	9	
	perlitic (martensitic)		260	17	150	180	230	9	140	170	220	9	
	Cast iron with spheroidal graphite	ferritic		160	18	225	270	345	9	215	250	330	9
		perlitic		250	19	175	210	270	9	160	200	250	9
	Malleable cast iron	ferritic		130	20	250	300	380	9	230	280	360	9
		perlitic		230	21	200	240	305	9	180	230	290	9
N Aluminium wrought alloys	cannot be hardened		60	22									
	hardenable	hardened	100	23									
	Cast aluminium alloys	$\leq 12\% \text{ Si}$, cannot be hardened		75	24								
		$\leq 12\% \text{ Si}$, hardenable	hardened	90	25								
		$> 12\% \text{ Si}$, cannot be hardened		130	26								
Copper and copper alloys (bronze/brass)	machining steel, PB> 1%		110	27									
	CuZn, CuSnZn		90	28									
	CuSn, Pb-free copper, electrolytic copper		100	29									
S Heat-resistant alloys	Fe-based alloys	annealed	200	30									
		hardened	280	31									
	Ni or Co bass	annealed	250	32									
		hardened	350	33									
		cast	320	34									
	Titanium alloys	pure titanium	R_m 400	35									
α and β alloys		hardened	R_m 1050	36									
H Hardened steel		hardened and tempered	55 HRC	37	115	140	175	9	100	120	150	9	
		hardened and tempered	60 HRC	38	-	-	-	-	-	-	-	-	
	Hard cast iron	cast	400	39	135	165	205	9	110	150	180	9	
	Hardened cast iron	hardened and tempered	55 HRC	40	-	-	-	-	-	-	-	-	
X Non-metallic materials	Thermoplasts			41									
	Thermosetting plastics			42									
	Plastic, glass-fibre reinforced GFRP			43									
	Plastic, carbon fibre reinforced CFRP			44									
	Graphite			45									
	Wood			46									

Note: The given cutting values are guide values, which were determined under ideal conditions.
The values have to be adapted in individual cases.
Feed rate recommendations on page B522.
For examples of material for cutting tool groups view page D11.

Deburring cutters – FM series

Material group	Composition / structure / heat treatment	Brinell hardness HB	Machining group	Starting values for cutting speed v_c [m/min]					
				5501 / 5601 5501 / 5601 5601					
				KMG303					
				a_e / D				f-group	
				1/1	1/2	1/10	f-group		
P Unalloyed steel	approx. 0,15 % C	annealed	125	1	-	-	230	11	
	approx. 0,45 % C	annealed	190	2	-	-	220	11	
	approx. 0,45 % C	tempered	250	3	-	-	165	11	
	approx. 0,75 % C	annealed	270	4	-	-	140	11	
	approx. 0,75 % C	tempered	300	5	-	-	130	11	
P Low-alloyed steel		annealed	180	6	-	-	175	11	
		tempered	275	7	-	-	140	11	
		tempered	300	8	-	-	130	11	
		tempered	350	9	-	-	120	11	
P High-alloyed steel and high-alloyed tool steel		annealed	200	10	-	-	165	11	
		hardened and tempered	325	11	-	-	125	11	
M Stainless steel	ferritic/martensitic	annealed	200	12	-	-	75	11	
	martensitic	tempered	240	13	-	-	65	11	
	austenitic	quench hardened	180	14	-	-	80	11	
	austenitic-ferritic		230	15	-	-	65	11	
K Grey cast iron	perlitic/ferritic		180	16	-	-	170	11	
	perlitic (martensitic)		260	17	-	-	140	11	
K Cast iron with spheroidal graphite	ferritic		160	18	-	-	210	11	
	perlitic		250	19	-	-	165	11	
K Malleable cast iron	ferritic		130	20	-	-	230	11	
	perlitic		230	21	-	-	185	11	
N Aluminium wrought alloys	cannot be hardened		60	22	-	-	1200	11	
	hardenable	hardened	100	23	-	-	720	11	
	≤ 12 % Si, cannot be hardened		75	24	-	-	480	11	
	≤ 12 % Si, hardenable	hardened	90	25	-	-	600	11	
N Cast aluminium alloys	> 12 % Si, cannot be hardened		130	26	-	-	180	11	
	machining steel, PB> 1%		110	27	-	-	360	11	
	CuZn, CuSnZn		90	28	-	-	420	11	
N Copper and copper alloys (bronze/brass)	CuSn, Pb-free copper, electrolytic copper		100	29	-	-	360	11	
	S Heat-resistant alloys	Fe-based alloys	annealed	200	30				
		hardened	280	31					
S Ni or Co bass	annealed	250	32						
	hardened	350	33						
	cast	320	34						
S Titanium alloys	pure titanium		R _m 400	35					
	α and β alloys	hardened	R _m 1050	36					
H Hardened steel		hardened and tempered	55 HRC	37					
		hardened and tempered	60 HRC	38					
H Hard cast iron		cast	400	39					
H Hardened cast iron		hardened and tempered	55 HRC	40					
X Non-metallic materials	Thermoplasts				41				
	Thermosetting plastics				42				
	Plastic, glass-fibre reinforced GFRP				43				
	Plastic, carbon fibre reinforced CFRP				44				
	Graphite				45				
	Wood				46				

Note: The given cutting values are guide values, which were determined under ideal conditions.
 The values have to be adapted in individual cases.
 Feed rate recommendations on page B522.
 For examples of material for cutting tool groups view page D11.

End mills – QCH series

Material group	Composition / structure / heat treatment	Brinell hardness HB	Machining group	Starting values for cutting speed v_c [m/min]										
				Q**-PM-4E Q**-PM-4R Q**-VPM-4E					Q**PM-2B Q**PM-4B					
				Slot milling		Shoulder milling								
				\varnothing [mm]	$a_{p\max}$	\varnothing [mm]	$a_{e\max}$	f [mm]	v_c [m/min]	v_c [m/min]	v_c [m/min]	v_c [m/min]	v_c [m/min]	v_c [m/min]
				$0 < x < 3$	$0,3 \times D$	$0 < x < 20$	$0,15 \times D$							
				KMG405					KMG405					
				a_e / D					a_e / D					
P Unalloyed steel	approx. 0,15 % C	annealed	125	1	1/1	1/2	1/10	f -group	1/1	1/2	1/10	f -group		
	approx. 0,45 % C	annealed	190	2	165	220	300	1	–	270	300	5		
	approx. 0,45 % C	tempered	250	3	160	210	285	1	–	260	285	5		
	approx. 0,75 % C	annealed	270	4	120	155	210	1	–	190	210	5		
	approx. 0,75 % C	tempered	300	5	100	135	180	1	–	165	180	5		
P Low-alloyed steel		annealed	180	6	95	125	165	1	–	150	165	5		
		tempered	275	7	125	165	225	1	–	205	225	5		
		tempered	300	8	100	135	180	1	–	165	180	5		
		tempered	350	9	95	125	165	1	–	150	165	5		
P High-alloyed steel and high-alloyed tool steel		annealed	200	10	90	115	160	1	–	145	160	5		
		hardened and tempered	325	11	120	155	210	1	–	190	210	5		
M Stainless steel	ferritic/martensitic	annealed	200	12	90	120	160	1	–	145	160	5		
	martensitic	tempered	240	13	55	75	100	1	–	90	100	5		
	austenitic	quench hardened	180	14	50	65	85	1	–	80	85	5		
	austenitic-ferritic		230	15	60	75	105	1	–	95	105	5		
K Grey cast iron	perlitic/ferritic		180	16	50	65	85	1	–	80	85	5		
	perlitic (martensitic)		260	17	125	165	220	1	–	200	220	5		
K Cast iron with spheroidal graphite	ferritic		160	18	100	135	180	1	–	165	180	5		
	perlitic		250	19	150	200	270	1	–	245	270	5		
K Malleable cast iron	ferritic		130	20	120	155	210	1	–	190	210	5		
	perlitic		230	21	165	220	300	1	–	270	300	5		
N Aluminium wrought alloys	cannot be hardened		60	22	135	180	240	1	–	220	240	5		
	hardenable	hardened	100	23										
	$\leq 12\%$ Si, cannot be hardened		75	24										
	$\leq 12\%$ Si, hardenable	hardened	90	25										
N Cast aluminium alloys	$> 12\%$ Si, cannot be hardened		130	26										
	machining steel, PB $>$ 1%		110	27										
	CuZn, CuSnZn		90	28										
S Copper and copper alloys (bronze/brass)	CuSn, Pb-free copper, electrolytic copper		100	29										
	Fe-based alloys	annealed	200	30										
		hardened	280	31										
	Ni or Co bass	annealed	250	32										
hardened		350	33											
S Titanium alloys	cast		320	34										
	pure titanium		R_m 400	35										
H Hardened steel	α and β alloys	hardened	R_m 1050	36										
	hardened and tempered	hardened and tempered	55 HRC	37	–	–	–	–						
H Hard cast iron	hardened and tempered	hardened and tempered	60 HRC	38	80	105	140	1						
	cast	cast	400	39	–	–	–	–						
H Hardened cast iron	hardened and tempered	hardened and tempered	55 HRC	40	105	140	185	1						
	Thermoplasts			41										
X Non-metallic materials	Thermosetting plastics			42										
	Plastic, glass-fibre reinforced GFRP			43										
	Plastic, carbon fibre reinforced CFRP			44										
	Graphite			45										
	Wood			46										

Note: The given cutting values are guide values, which were determined under ideal conditions.
 The values have to be adapted in individual cases.
 Feed rate recommendations on page B522.
 For examples of material for cutting tool groups view page D11.

Recommended feed rate

Solid carbide milling group 1 – Square shoulder mills PM series, QCH series, EPM series

	a_e / D	Feed rate per cutting edge (f_z) [mm]															
		$\emptyset 0,5$	$\emptyset 0,8$	$\emptyset 1$	$\emptyset 2$	$\emptyset 3$	$\emptyset 4$	$\emptyset 5$	$\emptyset 6$	$\emptyset 8$	$\emptyset 10$	$\emptyset 12$	$\emptyset 14$	$\emptyset 16$	$\emptyset 18$	$\emptyset 20$	
P	1/1	0,01	0,02	0,02	0,02	0,02	0,02	0,02	0,03	0,03	0,05	0,07	0,08	0,08	0,09	0,09	0,10
	1/2	0,01	0,03	0,03	0,03	0,03	0,03	0,04	0,04	0,06	0,09	0,10	0,10	0,12	0,12	0,13	
	1/10	0,02	0,05	0,05	0,05	0,05	0,05	0,07	0,07	0,09	0,14	0,16	0,16	0,18	0,18	0,20	
M	1/1	0,01	0,02	0,02	0,02	0,02	0,02	0,03	0,03	0,04	0,05	0,06	0,06	0,07	0,07	0,08	
	1/2	0,01	0,02	0,02	0,02	0,02	0,02	0,04	0,04	0,05	0,07	0,08	0,08	0,10	0,10	0,11	
	1/10	0,02	0,04	0,04	0,04	0,04	0,04	0,05	0,05	0,07	0,11	0,13	0,13	0,15	0,15	0,16	
K	1/1	0,01	0,02	0,02	0,02	0,02	0,02	0,03	0,03	0,05	0,07	0,08	0,08	0,09	0,09	0,10	
	1/2	0,01	0,03	0,03	0,03	0,03	0,03	0,04	0,04	0,06	0,09	0,10	0,10	0,12	0,12	0,13	
	1/10	0,02	0,05	0,05	0,05	0,05	0,05	0,07	0,07	0,09	0,14	0,16	0,16	0,18	0,18	0,20	
H	1/1	0,01	0,02	0,02	0,02	0,02	0,02	0,03	0,03	0,04	0,05	0,06	0,06	0,07	0,07	0,08	
	1/2	0,01	0,02	0,02	0,02	0,02	0,02	0,04	0,04	0,05	0,07	0,08	0,08	0,10	0,10	0,11	
	1/10	0,02	0,04	0,04	0,04	0,04	0,04	0,05	0,05	0,07	0,11	0,13	0,13	0,15	0,15	0,16	

Note: The given cutting values are guide values, which were determined under ideal conditions.
The values have to be adapted in individual cases.

Solid carbide milling group 2 – Square shoulder mills GM series

	a_e / D	Feed rate per cutting edge (f_z) [mm]															
		$\emptyset 0,5$	$\emptyset 0,8$	$\emptyset 1$	$\emptyset 2$	$\emptyset 3$	$\emptyset 4$	$\emptyset 5$	$\emptyset 6$	$\emptyset 8$	$\emptyset 10$	$\emptyset 12$	$\emptyset 14$	$\emptyset 16$	$\emptyset 18$	$\emptyset 20$	
P	1/1	0,01	0,02	0,02	0,02	0,02	0,02	0,03	0,03	0,04	0,06	0,07	0,07	0,08	0,08	0,09	
	1/2	0,01	0,03	0,03	0,03	0,03	0,03	0,04	0,04	0,05	0,08	0,09	0,09	0,10	0,10	0,12	
	1/10	0,02	0,04	0,04	0,04	0,04	0,04	0,06	0,06	0,08	0,12	0,14	0,14	0,16	0,16	0,18	
M	1/1	0,01	0,02	0,02	0,02	0,02	0,02	0,02	0,03	0,03	0,05	0,06	0,06	0,06	0,06	0,07	
	1/2	0,01	0,02	0,02	0,02	0,02	0,02	0,03	0,03	0,04	0,06	0,07	0,07	0,08	0,08	0,09	
	1/10	0,02	0,03	0,03	0,03	0,03	0,03	0,05	0,05	0,06	0,10	0,11	0,11	0,13	0,13	0,15	
K	1/1	0,01	0,02	0,02	0,02	0,02	0,02	0,03	0,03	0,04	0,06	0,07	0,07	0,08	0,08	0,09	
	1/2	0,01	0,03	0,03	0,03	0,03	0,03	0,04	0,04	0,05	0,08	0,09	0,09	0,10	0,10	0,12	
	1/10	0,02	0,04	0,04	0,04	0,04	0,04	0,06	0,06	0,08	0,12	0,14	0,14	0,16	0,16	0,18	

Note: The given cutting values are guide values, which were determined under ideal conditions.
The values have to be adapted in individual cases.

Solid carbide milling group 3 – Square shoulder mills HM series, QCH series

	a_e / D	Feed rate per cutting edge (f_z) [mm]															
		$\emptyset 0,5$	$\emptyset 0,8$	$\emptyset 1$	$\emptyset 2$	$\emptyset 3$	$\emptyset 4$	$\emptyset 5$	$\emptyset 6$	$\emptyset 8$	$\emptyset 10$	$\emptyset 12$	$\emptyset 14$	$\emptyset 16$	$\emptyset 18$	$\emptyset 20$	
H	1/1	0,01	0,02	0,02	0,02	0,02	0,02	0,02	0,02	0,03	0,05	0,06	0,06	0,06	0,06	0,07	
	1/2	0,01	0,02	0,02	0,02	0,02	0,02	0,03	0,03	0,04	0,06	0,07	0,07	0,08	0,08	0,09	
	1/10	0,02	0,03	0,03	0,03	0,03	0,03	0,05	0,05	0,06	0,10	0,11	0,11	0,13	0,13	0,15	

Note: The given cutting values are guide values, which were determined under ideal conditions.
The values have to be adapted in individual cases.

Solid carbide milling group 4 – Square shoulder mills AL series, NM series

	a_e / D	Feed rate per cutting edge (f_z) [mm]															
		$\emptyset 0,5$	$\emptyset 0,8$	$\emptyset 1$	$\emptyset 2$	$\emptyset 3$	$\emptyset 4$	$\emptyset 5$	$\emptyset 6$	$\emptyset 8$	$\emptyset 10$	$\emptyset 12$	$\emptyset 14$	$\emptyset 16$	$\emptyset 18$	$\emptyset 20$	
N	1/1	0,02	0,03	0,03	0,03	0,03	0,03	0,05	0,05	0,06	0,09	0,11	0,11	0,12	0,12	0,14	
	3/4	0,02	0,04	0,04	0,04	0,04	0,04	0,06	0,06	0,08	0,12	0,14	0,14	0,16	0,16	0,18	
	1/10	0,03	0,06	0,06	0,06	0,06	0,06	0,09	0,09	0,12	0,19	0,22	0,22	0,25	0,25	0,28	
	1/20	0,04	0,08	0,08	0,08	0,08	0,08	0,12	0,12	0,16	0,23	0,27	0,27	0,31	0,31	0,35	

Note: The given cutting values are guide values, which were determined under ideal conditions.
The values have to be adapted in individual cases.

Recommended feed rate

Solid carbide milling group 5 – Ball nose cutters GM series, QCH series, EPM series

	a _e / D	Feed rate per cutting edge (f _z) [mm]															
		Ø0,5	Ø0,8	Ø 1	Ø 2	Ø 3	Ø 4	Ø 5	Ø 6	Ø 8	Ø 10	Ø 12	Ø 14	Ø 16	Ø 18	Ø 20	
P	1/1																
	1/10	0,02	0,05	0,05	0,05	0,05	0,05	0,07	0,07	0,09	0,14	0,16	0,16	0,18	0,18	0,20	
	1/20	0,03	0,06	0,06	0,06	0,06	0,06	0,08	0,08	0,11	0,17	0,20	0,20	0,23	0,23	0,25	
M	1/1																
	1/10	0,02	0,04	0,04	0,04	0,04	0,04	0,05	0,05	0,07	0,11	0,13	0,13	0,15	0,15	0,16	
	1/20	0,02	0,05	0,05	0,05	0,05	0,05	0,07	0,07	0,09	0,14	0,16	0,16	0,18	0,18	0,21	
K	1/1																
	1/10	0,02	0,05	0,05	0,05	0,05	0,05	0,07	0,07	0,09	0,14	0,16	0,16	0,18	0,18	0,20	
	1/20	0,03	0,06	0,06	0,06	0,06	0,06	0,08	0,08	0,11	0,17	0,20	0,20	0,23	0,23	0,25	
H	1/1																
	1/10	0,02	0,04	0,04	0,04	0,04	0,04	0,05	0,05	0,07	0,11	0,13	0,13	0,15	0,15	0,16	
	1/20	0,02	0,05	0,05	0,05	0,05	0,05	0,07	0,07	0,09	0,14	0,16	0,16	0,18	0,18	0,21	

Note: The given cutting values are guide values, which were determined under ideal conditions.
The values have to be adapted in individual cases.

Solid carbide milling group 6 – High feed mills PM series

	a _e / D	Feed rate per cutting edge (f _z) [mm]							
		Ø 3	Ø 4	Ø 5	Ø 6	Ø 8	Ø 10	Ø 12	
P	1/1								
	1/10								
	1/20	0,15	0,25	0,28	0,33	0,44	0,55	0,66	
M	1/1								
	1/10								
	1/20	0,12	0,22	0,25	0,30	0,41	0,52	0,63	
K	1/1								
	1/10								
	1/20	0,15	0,25	0,28	0,33	0,44	0,55	0,66	
H	1/1								
	1/10								
	1/20	0,12	0,22	0,25	0,30	0,41	0,52	0,63	

Note: The given cutting values are guide values, which were determined under ideal conditions.
The values have to be adapted in individual cases.

Solid carbide milling group 7 – Ball nose cutters HM series, QCH series

	a _e / D	Feed rate per cutting edge (f _z) [mm]															
		Ø0,5	Ø0,8	Ø 1	Ø 2	Ø 3	Ø 4	Ø 5	Ø 6	Ø 8	Ø 10	Ø 12	Ø 14	Ø 16	Ø 18	Ø 20	
H	1/1																
	1/2	0,02	0,04	0,04	0,04	0,04	0,04	0,05	0,05	0,07	0,11	0,13	0,13	0,15	0,15	0,16	
	1/10	0,02	0,05	0,05	0,05	0,05	0,05	0,07	0,07	0,09	0,14	0,16	0,16	0,18	0,18	0,21	

Note: The given cutting values are guide values, which were determined under ideal conditions.
The values have to be adapted in individual cases.

Solid carbide milling group 8 – High feed mills AL series, ALP/ALG series

	a _e / D	Feed rate per cutting edge (f _z) [mm]								
		Ø 6	Ø 8	Ø 10	Ø 12	Ø 14	Ø 16	Ø 18	Ø 20	
N	1/1	0,04	0,05	0,08	0,09	0,11	0,13	0,16	0,18	
	3/4	0,05	0,07	0,10	0,12	0,14	0,16	0,20	0,23	
	1/10	0,08	0,11	0,16	0,19	0,22	0,25	0,31	0,36	

Note: The given cutting values are guide values, which were determined under ideal conditions.
The values have to be adapted in individual cases.

A

Turning

B

Milling

C

Drilling

D

Technical Information

E

Index

A

Recommended feed rate

Turning

Solid carbide milling group 9 – Square shoulder mills UM/UMC series, VPM series HSC/HPC

	a _e / D	Feed rate per cutting edge (f _z) [mm]																	
		Ø 4	Ø 5	Ø 6	Ø 8	Ø 10	Ø 12	Ø 14	Ø 16	Ø 18	Ø 20								
P	1/1	0,06	0,06	0,06	0,07	0,07	0,07	0,07	0,08	0,08	0,08								
	1/2	0,08	0,08	0,08	0,09	0,09	0,09	0,09	0,10	0,10	0,10								
	1/10	0,14	0,14	0,16	0,18	0,22	0,25	0,27	0,3	0,32	0,36								
M	1/1	0,05	0,05	0,05	0,05	0,05	0,05	0,05	0,06	0,06	0,06								
	1/2	0,06	0,06	0,06	0,07	0,07	0,07	0,07	0,08	0,08	0,08								
	1/10	0,10	0,10	0,10	0,12	0,12	0,14	0,16	0,16	0,18	0,18								
K	1/1	0,06	0,06	0,06	0,07	0,07	0,07	0,07	0,08	0,08	0,08								
	1/2	0,08	0,08	0,08	0,09	0,09	0,09	0,09	0,10	0,10	0,10								
	1/10	0,14	0,14	0,16	0,18	0,22	0,25	0,27	0,3	0,32	0,36								
H	1/1	0,045	0,045	0,045	0,053	0,053	0,053	0,053	0,06	0,06	0,06								
	1/2	0,06	0,06	0,06	0,07	0,07	0,07	0,07	0,08	0,08	0,08								
	1/10	0,10	0,10	0,10	0,12	0,12	0,14	0,16	0,16	0,18	0,18								

Note: The given cutting values are guide values, which were determined under ideal conditions.
The values have to be adapted in individual cases.

B

Milling

Solid carbide milling group 10 – Square shoulder mills VSM series, TM series

	a _e / D	Feed rate per cutting edge (f _z) [mm]																	
		Ø 4	Ø 5	Ø 6	Ø 8	Ø 10	Ø 12	Ø 14	Ø 16	Ø 18	Ø 20								
P	1/1	0,03	0,04	0,05	0,05	0,05	0,05	0,06	0,06	0,07	0,08								
	1/2	0,04	0,06	0,07	0,07	0,07	0,07	0,08	0,09	0,10	0,11								
	1/10	0,05	0,08	0,09	0,09	0,09	0,09	0,11	0,12	0,14	0,15								
M	1/1	0,02	0,03	0,04	0,04	0,04	0,04	0,04	0,05	0,05	0,06								
	1/2	0,03	0,05	0,05	0,05	0,05	0,05	0,06	0,07	0,08	0,08								
	1/10	0,04	0,06	0,07	0,07	0,07	0,07	0,08	0,09	0,10	0,11								
S	1/1	0,02	0,03	0,04	0,04	0,04	0,04	0,04	0,05	0,05	0,06								
	1/2	0,03	0,05	0,05	0,05	0,05	0,05	0,06	0,07	0,08	0,08								
	1/10	0,04	0,06	0,07	0,07	0,07	0,07	0,08	0,09	0,10	0,11								

Note: The given cutting values are guide values, which were determined under ideal conditions.
The values have to be adapted in individual cases.

C

Drilling

Solid carbide milling group 11 – Deburring cutters FM series

	a _e / D	Feed rate per cutting edge (f _z) [mm]																			
		Ø 3	Ø 4	Ø 5	Ø 6	Ø 8	Ø 10	Ø 12	Ø 14	Ø 16	Ø 18	Ø 20									
P	1/1																				
	1/2																				
	1/10	0,02	0,02	0,03	0,03	0,04	0,06	0,07	0,07	0,08	0,08	0,09									
M	1/1																				
	1/2																				
	1/10	0,02	0,02	0,02	0,02	0,03	0,05	0,06	0,06	0,06	0,06	0,07									
K	1/1																				
	1/2																				
	1/10	0,02	0,02	0,03	0,03	0,04	0,06	0,07	0,07	0,08	0,08	0,09									
N	1/1																				
	1/2																				
	1/10	0,03	0,03	0,05	0,05	0,06	0,09	0,11	0,11	0,12	0,12	0,14									

Note: The given cutting values are guide values, which were determined under ideal conditions.
The values have to be adapted in individual cases.

D

Technical Information

E

Index

Recommended feed rate

Solid carbide milling group 12 – ALP-1EP single-edged cutters

	a _e / D	Feed rate per cutting edge (f _z) [mm]																	
		Ø 2	Ø 3	Ø 4	Ø 5	Ø 6	Ø 8	Ø 10											
N	1/1	0,03	0,05	0,07	0,09	0,11	0,14	0,18											
	1/2	0,04	0,07	0,10	0,13	0,15	0,20	0,25											
	1/10	0,06	0,11	0,15	0,19	0,23	0,29	0,38											

Note: The given cutting values are guide values, which were determined under ideal conditions.
The values have to be adapted in individual cases.

A

Turning

B

Milling

C

Drilling

D

Technical Information

E

Index

A

Turning

B

Milling

C

Drilling

D

Technical
Information

E

Index

B

Technical information

Trouble shooting – milling

B528

Technical information – milling

B529-B540

Special tools – milling

B541

Trouble shooting – indexable milling

Fig.	Type of wear	Effects	Reason	Countermeasure
1+2	Flank wear	<ul style="list-style-type: none"> – Bad surface quality and dimensional stability – Increase of cutting force 	<ul style="list-style-type: none"> – Grade not wear-resistant enough – Cutting speed too high – Clearance angle too small – Feed rate too low 	<ul style="list-style-type: none"> – Grade with higher wear-resistance – Reduce cutting speed – Increase clearance angle – Reduce feed rate
3	Crater wear	<ul style="list-style-type: none"> – Bad surface quality and chip control 	<ul style="list-style-type: none"> – Grade not wear-resistant enough – Cutting speed too high – Feed rate too low 	<ul style="list-style-type: none"> – Grade with higher wear-resistance – Reduce cutting speed – Reduce feed rate
4	Chipping	<ul style="list-style-type: none"> – Unstable tool life – Sudden breakage of cutting edge 	<ul style="list-style-type: none"> – Grade too hard – Feed rate too high – Cutting edge not stable enough – Stability of the holder or tension insufficient 	<ul style="list-style-type: none"> – Grade with higher toughness – Reduce feed rate – Change honing of cutting edge – Use a more stable tool holder
5	Breakage	<ul style="list-style-type: none"> – Increase of cutting force – Bad surface quality and dimensional stability 	<ul style="list-style-type: none"> – Grade too hard – Feed rate too high – Cutting edge not stable enough – Stability of the holder or tension insufficient 	<ul style="list-style-type: none"> – Grade with higher toughness – Reduce feed rate – Change honing of cutting edge – Use a more stable tool holder
6	Plastic deformation	<ul style="list-style-type: none"> – Bad dimensional stability – Damage to cutting edge 	<ul style="list-style-type: none"> – Grade not wear-resistant enough – Cutting speed too high – Cutting depth and/or feed rate too high – Temperature on the cutting edge too high 	<ul style="list-style-type: none"> – Grade with higher toughness – Reduce cutting speed – Reduce cutting depth and feed rate – Grade with higher heat-resistance
7	Welding	<ul style="list-style-type: none"> – Increase of cutting force – Bad surface quality 	<ul style="list-style-type: none"> – Cutting speed too low – Cutting edge not sharp enough – Grade not suitable 	<ul style="list-style-type: none"> – Increase cutting speed – Increase rake angle – Use a more suitable grade
8	Thermal cracks	<ul style="list-style-type: none"> – Breakage due to thermal interaction, often caused when cutting is interrupted (milling) 	<ul style="list-style-type: none"> – Temperature fluctuation when machining – Grade too hard 	<ul style="list-style-type: none"> – Dry machining – Grade with higher toughness
9	Notch wear	<ul style="list-style-type: none"> – Burr formation – Increase of cutting force 	<ul style="list-style-type: none"> – Damage through chips (jagged edges) – Feed rate and cutting speed too high 	<ul style="list-style-type: none"> – Grade with higher wear-resistance – Increase rake angle to get a sharper cutting edge – Reduce cutting speed
10	Flaking (coating)	<ul style="list-style-type: none"> – Often appears when machining hardened materials or caused by vibration 	<ul style="list-style-type: none"> – Cutting edge adhesion and chipping – Bad chip removal 	<ul style="list-style-type: none"> – Increase rake angle to get a sharper cutting edge – Chip breaker with bigger chip space

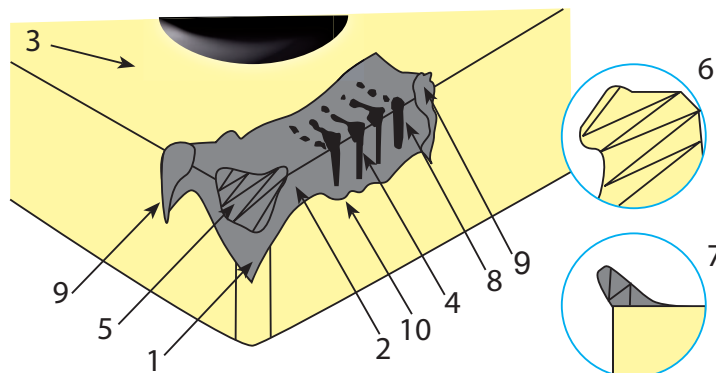

A

Turning

B

Milling

C

Drilling

D

Technical Information

E

Index

Indexable milling

Difference between up-milling and down-milling

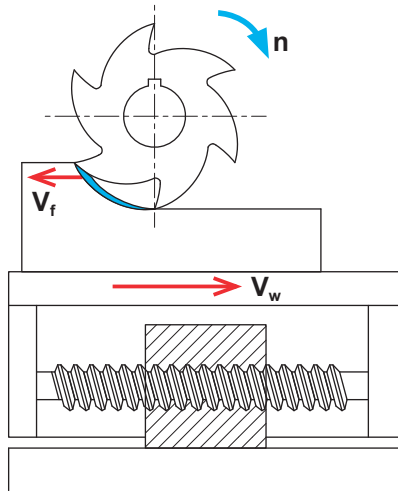

Up-milling

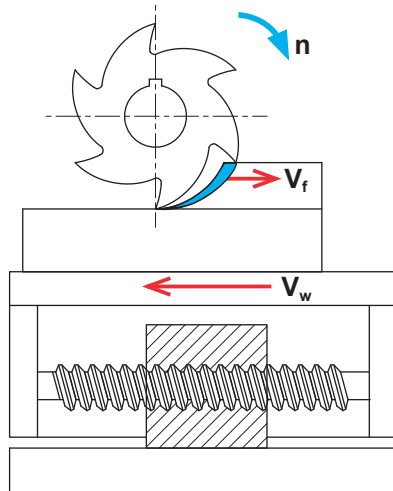

Down-milling

V_f Feed rate tool
 V_w Feed rate work piece
 n Rotation

Up-milling: the feed direction of the work piece is opposite to that of the milling rotation at the connecting position.

Down-milling: the feed direction of the work piece is the same as that of the milling rotation at the connecting position.

Advantages and disadvantages

Direction	Advantages	Disadvantages
Up-milling	<ul style="list-style-type: none"> - Prevents hooking of tool - More smooth cut 	<ul style="list-style-type: none"> - Bigger stress on cutting edge - Shorter tool life
Down-milling	<ul style="list-style-type: none"> - Higher tool life - Less thermal stress 	<ul style="list-style-type: none"> - Hooking of tool possible

A

Turning

B

Milling

C

Drilling

D

Technical Information

E

Index



A

Indexable milling

Pitch selection

The pitch is the distance between one point on one cutting edge and the same point on the next edge. Milling cutters are mainly classified into wide, normal and fine pitches.

Turning

Operational stability		
L (low)	M (medium)	H (high)
Wide pitch	Normal pitch	Fine pitch
		
When the milling width is equal to the diameter of the cutter, the machining system is stable and main power of machine is sufficient, selecting a wide pitch can achieve high productive efficiency.	General milling function and multiple mixed productions.	When the milling width is less than the diameter of cutter, cutting by maximum edges can achieve high productive efficiency.

B

Milling

C

Approach angle

The approach angle is composed by insert. Tool body, chip thickness, cutting forces and tool life are affected especially by the approach angle. Decreasing the approach angle reduces chip thickness and spreads the cutting area between cutting edge and work piece for a given feed rate. A smaller approach angle also guarantees stable entering or exiting the work piece, to protect the cutting edge and extend tool life. However this will increase higher axial cutting forces on the work piece, thus it is not suitable for machining thin work pieces such as thin plates.

Drilling

Approach angle	Feed rate per tooth	Max. cutting depth
90°	f_z	$h_{ex} = f_z \times \sin \alpha_r$
75°		$h_{ex} = 0,96 \times f_z$
60°		$h_{ex} = 0,86 \times f_z$
45°		$h_{ex} = 0,707 \times f_z$
Round		$h_{ex} = \frac{\sqrt{iC^2 \times (iC - 2a_p)^2}}{iC} \times f_z$

D

Technical Information

E

Index

Indexable milling

General formulas

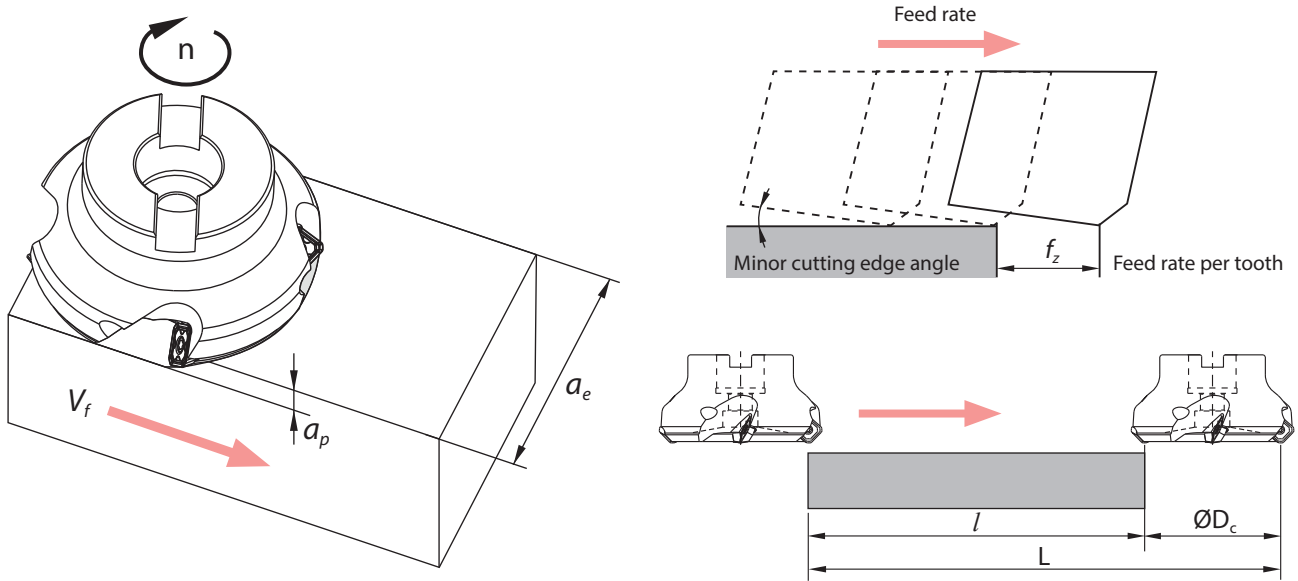

V_c : Feed rate [m/min]
 D_c : Nominal diameter of milling tool [mm]
 n : Spindle speed [u/min]
 z_n : Number of teeth
 Q : Metal removal rate [cm³/min]

V_f : Feed rate of worktable (feed speed) [mm/min]
 f_z : Feed rate per tooth [mm/z]
 π : ~3,14
 T_c : Machining time [min]
 f_n : Feed rate per revolution [mm/u]

Cutting speed	$V_c = \frac{\pi \times D_c \times n}{1000} \text{ [m/min]}$
Spindle speed	$n = \frac{1000 \times V_c}{\pi \times D_c} \text{ [rev/min]}$
Feed rate of work table	$V_f = f_z \times n \times z_n \text{ [mm/min]}$
Feed rate per tooth	$f_z = \frac{V_f}{n \times z_n} \text{ [mm/z]}$
Feed rate per revolution	$f_n = \frac{V_f}{n} \text{ [mm/rev]}$
Machining time	$T_c = \frac{1000 \times V_c}{\pi \times D_c} \text{ [min]}$
Metal removal rate	$Q = \frac{a_p \times a_e \times V_f}{1000} \text{ [cm}^3\text{/min]}$

A

Turning

B

Milling

C

Drilling

D

Technical Information

E

Index

A

Indexable milling

Function of angles when face milling

Turning

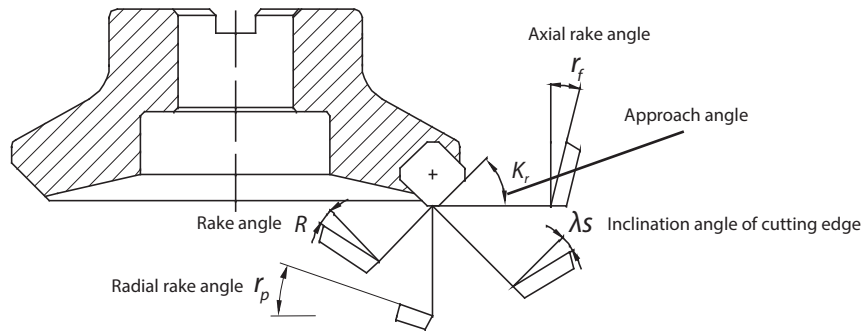

B

Main angles

Angle	Feature	Effet		
Axial rake angle r_f	Influences chip direction	Negative angle, good chip removal		
Radial rake angle r_p	Influences cutting edge sharpness	Positive angle, good cutting performance		
Approach angle K_r	Influences chip thickness	$K_r \uparrow$, chip thickness \uparrow ; $K_r \downarrow$, chip thickness \downarrow ;		
Rake angle R	Influences cutting force	Poor cutting performance, stable cutting edge	$(-) \leftarrow 0 \rightarrow (+)$	Good cutting performance, unstable cutting edge
Inclination angle λ_s	Influences chip flow direction	Poor cutting performance, stable cutting edge	$(-) \leftarrow 0 \rightarrow (+)$	Good cutting performance, unstable cutting edge

Milling

C

Combination of different rake angles

		Double positive	Double negative	Positive/Negative
Negative rake angle				
Neutral angle				
Positive angle				
Axial rake angle r_f		+	-	+
Radial rake angle r_p		+	-	-
Application field	P	√		√
	M	√		√
	K		√	√
	N	√		
	S	√		√

Drilling

D

Technical Information

E

Index

Indexable milling

Cutting performances of different approach angles

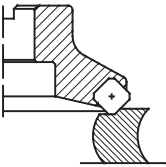
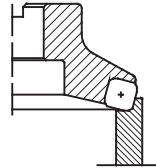
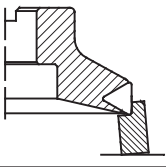
Approach angle	Depiction	Explanation
45°		Axial force is largest. It will bend when machining thin-wall work piece, and reduces the precision of work piece. It is benefit to avoid fringe breakage of work piece when machining cast iron.
75°		The main purpose is to resolve the radial cutting force, it is often used for general face milling.
90°		The axial force is zero in theory, suitable for milling thin plate workpiece.

Inserts with wiper

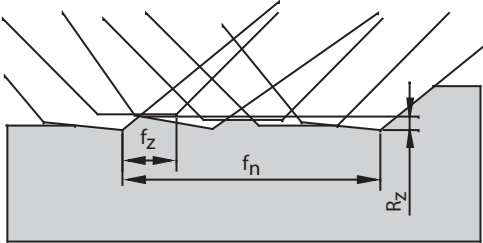
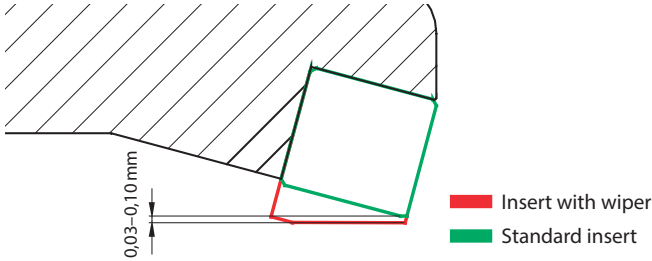
Using standard inserts	Using inserts with wiper
 <p>Normal surface quality</p>	 <p>High surface quality</p>

The wiper insert must protrude below the other inserts by 0.03–0.10 mm at axial direction, only that the wiping function can take into effect. Generally speaking, a cutter can assemble only one wiper insert. If the diameter of cutter is much bigger or cutter's feed rate per revolution is bigger than the length of wiper edge, 2 to 3 wiper inserts can be assembled.

Cutting width

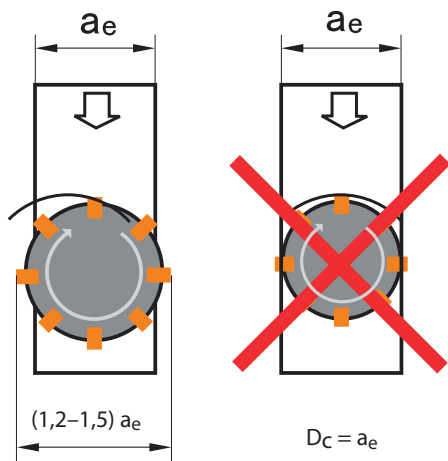

Generally speaking, the relation between cutting width and tool cutting diameter is $D_c = (1.2-1.5) a_e$.

In the machining practice, it needs to avoid coincidence of tool center and workpiece center as much as possible.

D_c : Tool diameter
 a_e : Lateral infeed

A

Turning

B

Milling

C

Drilling

D

Technical Information

E

Index

Indexable milling

Plunging and circular milling with insert APKT

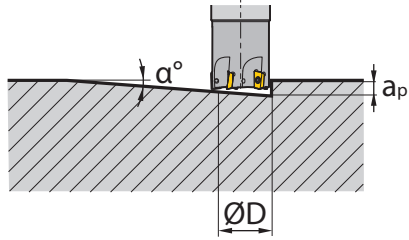
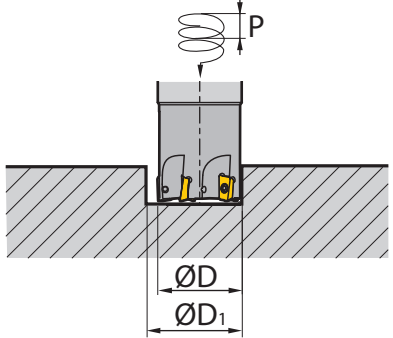
		Plunging		Circular milling	
					
		$L_m = \frac{a_p}{\tan \alpha}$ <p>α : Angle de plongée</p>		$P = \tan \alpha \times \pi \times D_1$ <p>α : Angle d'hélice</p>	
Insert	Diameter ϕD [mm]	Max. cutting depth a_p [mm]	Max. plunge angle α°	Min. diameter ϕD_1 [mm]	Max. diameter [mm]
AP**11**	16	10	10	20	30
	20	10	5	28	38
	25	10	4	40	48
	32	10	3	56	60
	40	10	2	70	76

Reduce the feed rate when plunging and circular milling.
 For drilling operations (axial) set the feed rate under 0.2mm.
 „Attention“ – drilling can form long chips.

A

Turning

B

Milling

C

Drilling

D

Technical Information

E

Index

Indexable milling

Plunging and circular milling with insert WPGT or SDMT

Approx. programmed radius

Insert	approx. R [mm]	Residual material K [mm]
WPGT050315ZSR	2	0,5
WPGT060415ZSR	2,5	0,7
WPGT080615ZSR	2,5	0,7
WPGT090725ZSR	4,5	1,2
SDMT06T208	1,6	0,5
SDMT09T312	2,5	0,87
SDMT120412	4,0	0,93
SDMT150620	4,0	1,38

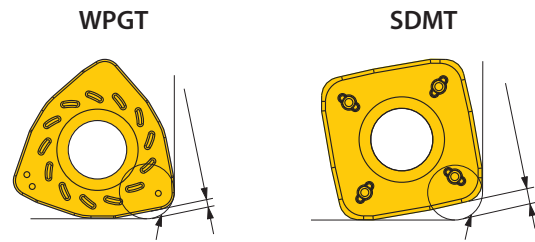

Insert WPGT

Insert	Diameter ØD [mm]	Plunging		Circular milling	
		Max. cutting depth a _p [mm]	Max. plunge angle α°	Min. diameter ØD ₁ [mm]	Max. diameter [mm]
WP**05**	20	1,5	12	24	37
	25	1,5	8,8	31	47
WP**06**	32	1,5	5	45	61
	40	1,5	3,2	61	77
	50	1,5	2,8	81	97
WP**08**	40	1,5	9	52	77
	50	1,5	5,4	71	97
	63	1,5	4,3	97	123
	80	1,5	2,9	131	157
	100	1,5	2,1	171	197
	125	1,5	1,3	221	247
WP**09**	160	1,5	1,1	291	317
	50	3,0	7,2	70	96
	63	3,0	4,5	96	122
	80	3,0	2,8	130	156
	100	3,0	2,2	170	196
	125	3,0	1,6	220	246
	160	3,0	1,2	290	316

Reduce the feed rate when plunging and circular milling.
For drilling operations (axial) set the feed rate under 0.2 mm.
„Attention“ – drilling can form long chips.

Indexable milling

Insert SDMT

A

Turning

B

Milling

C

Drilling

D

Technical Information

E

Index

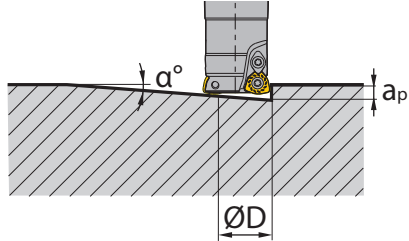
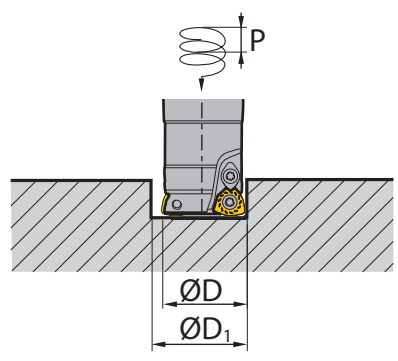
		Plunging		Circular milling	
					
		$L_m = \frac{a_p}{\tan \alpha}$ <p>α: Plunge angle</p>		$P = \tan \alpha \times \pi \times D_1$ <p>α: Helix angle</p>	
Insert	Diameter $\varnothing D$ [mm]	Max. cutting depth a_p [mm]	Max. plunge angle α°	Min. diameter $\varnothing D_1$ [mm]	Max. diameter [mm]
SD**06**	20	0,8	3,6	30	38
	25	0,8	2,8	40	48
	32	0,8	1,6	52	60
	40	0,8	1,1	70	78
	50	0,8	0,8	90	98
	63	0,8	0,7	114	122
SD**09**	25	1,4	6,5	34	48
	32	1,4	4,5	48	62
	35	1,4	3,6	54	68
	50	1,4	1,8	84	98
	63	1,4	1,3	110	124
SD**12**	32	1,8	10,4	44	60
	40	1,8	5,7	60	76
	50	1,8	3,5	80	96
	63	1,8	2,5	106	122
	80	1,8	1,6	140	156
	100	1,8	1,2	180	196
SD**15**	40	2,2	7,3	54	76
	80	2,2	1,4	134	156
	100	2,2	1,0	174	196
	125	2,2	0,9	234	246
	160	2,2	0,6	304	316

Reduce the feed rate when plunging and circular milling.
 For drilling operations (axial) set the feed rate under 0,2mm.
 „Attention“ – drilling can form long chips.

Solid carbide mills

Terminology

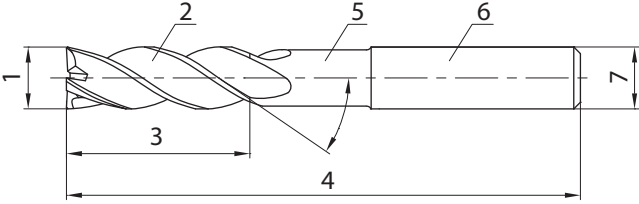
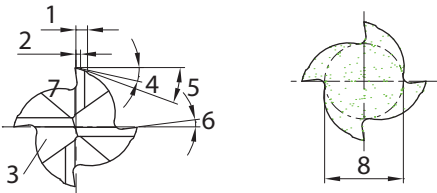
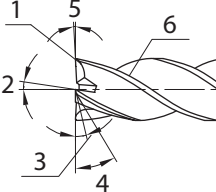
<p>A</p>		<ol style="list-style-type: none"> 1. Cutting edge diameter 2. Chip pocket 3. Length of cutting edge 4. Total length 5. Neck 6. Shank 7. Shank diameter
<p>B</p>		<ol style="list-style-type: none"> 1. Chamfer width, main cutting edge 2. Chamfer width, diameter 3. Neck, front side 4. Primary radial clearance angle 5. Secondary radial clearance angle 6. Radial rake angle 7. Axial main cutting edge 8. Core diameter
<p>C</p>		<ol style="list-style-type: none"> 1. Cutting edge 2. Axial rake angle 3. Primary axial clearance angle 4. Secondary axial clearance angle 5. Inclination angle 6. Radial cutting edge

Teeth, chip pocket and tool rigidity

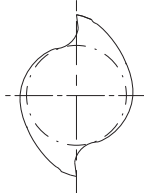
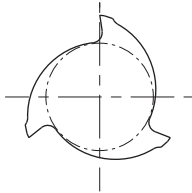
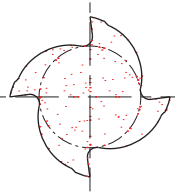
Teeth	2 flutes	3 flutes	4 flutes
Cross section			
Cutting edge ratio	54 %	56 %	60 %
Advantages	<ul style="list-style-type: none"> - Large chip pocket - Good chip removal 	<ul style="list-style-type: none"> - Good chip removal - Good surface quality 	<ul style="list-style-type: none"> - Good rigidity - Good surface
Application	<ul style="list-style-type: none"> - Slot milling - Square shoulder milling - Drilling 	<ul style="list-style-type: none"> - Slot milling - Square shoulder milling - Finishing 	<ul style="list-style-type: none"> - Slot milling (flat) - Square shoulder milling - Finishing

Length of cutting edge (overhang) and cutting diameter

The shorter the overhang, the stronger the rigidity. Thus isn't easy to generate. Bend and vibration in the cutting process may occur.

Length (overhang) increases by 1 time, the deflection degree (f) will be 8 times of the former one.

**Reduce the overhang by 20 %
the deflection degree (f) will decrease by 50 %**

**Increase the diameter by 20 %
the deflection degree (f) will decrease by 50 %**

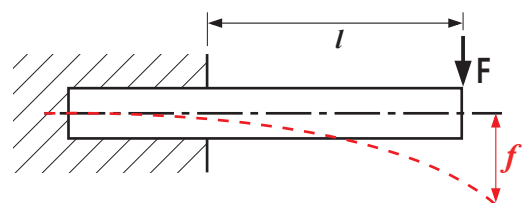

$$f = \frac{F \times l^3}{3 \times E \times I} = \frac{F \times l^3 \times 64}{3 \times E \times I}$$

A

Turning

B

Milling

C

Drilling

D

Technical Information

E

Index

A

Solid carbide mills

Machining strategy – HPC/UM (HSC) milling cutters

Turning

HPC = High Performance Cutting

Machining with significantly increased metal removal rate through higher cutting speeds and feed rates compared with conventional machine cutting processes.

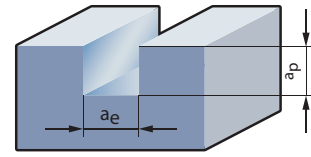

Full-slot milling

B

HSC (UM) = High Speed Cutting

High cutting speeds and feed rates in combination with low cutting depths lead to lower chip thickness as in normal machining.

Milling

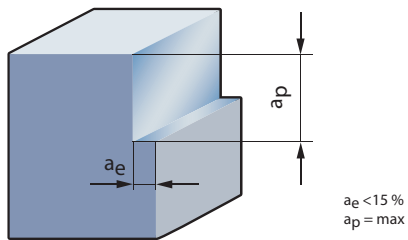

Profiling

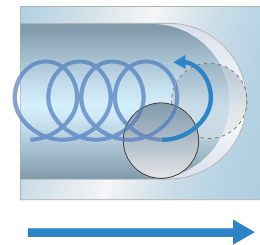

Trochoidal milling

C

Drilling

The UM milling cutter is specifically optimised for HSC machining.

D

Technical Information

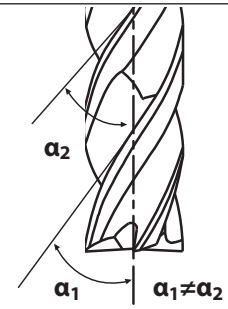
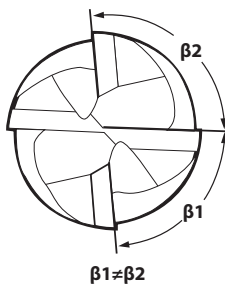

High metal removal rates can be realised with this tool.

Especially on highly dynamic machines with optimised tool paths this milling cutter shows its full potential.

E

Index

Solid carbide mills

HSC strategy

It's important to use the right strategy. When programming make sure the width of cut is kept. The width of cut is usually not higher than 15 %. Regarding the depth of cut, the total length of the cutting edge can be used.

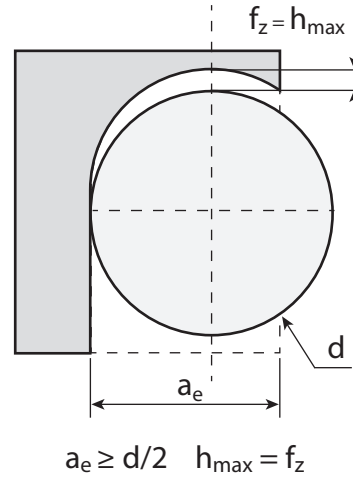
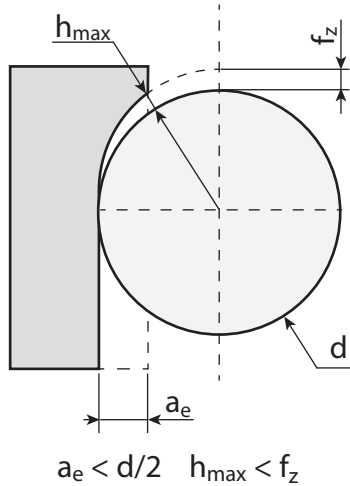

$$h_{max} = 2f_z \sqrt{\frac{a_e}{d} \left(1 - \frac{a_e}{d}\right)}$$

When changing the width of cut the cutting data needs to be adjusted. As calculatory size applies a chip thickness from approx. 0.15–0.2 mm on basis of the usual steel types.

Example

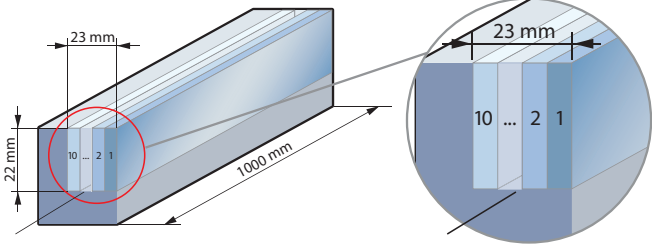
Tool	Machining
 <p>UM-4E-D20.0-W KMG405</p>	 <p>HSC strategy</p> <p>$a_e < 15\%$ $a_p = \max$</p>

Workpiece material

16MnCr5 (1.7131) ca. 700 N/mm³

Cutting data

V_c	550 m/min
n	8750 1/min
f_z	0,3 mm ($h_{max} = 0,19$ mm)
V_f	10500 mm/min
a_p	22 mm
a_e	2,3 mm

Result

Chip removal rate **530 cm³/min!** Machining time 58 seconds! The maximum chip thickness is 0.19 mm.

A

Turning

B

Milling

C

Drilling

D

Technical Information

E

Index

Solid carbide mills

Feed rate selecting table for profile machining with ball nose cutters and torus mills

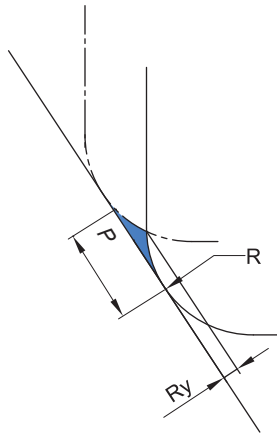

$$R_y = R \times \{1 - \cos [\arcsin (fr/2R)]\}$$

R_y: Theoretical values of surface quality

P: Feed rate

R: Radius of the ball nose cutter or torus mill

R	R _y	Feed rate									
		0,1	0,2	0,3	0,4	0,5	0,6	0,7	0,8	0,9	1,0
0,5		0,003	0,010	0,023	0,042	0,067	0,100				
1,0		0,001	0,005	0,011	0,020	0,032	0,046	0,063	0,083	0,107	
1,5		0,001	0,003	0,008	0,013	0,021	0,030	0,041	0,054	0,069	0,086
2,0		0,001	0,003	0,006	0,010	0,015	0,023	0,031	0,040	0,051	0,064
2,5		0,001	0,002	0,005	0,008	0,013	0,018	0,025	0,032	0,041	0,051
3,0			0,001	0,004	0,007	0,010	0,015	0,020	0,027	0,034	0,042
4,0			0,001	0,003	0,005	0,008	0,011	0,015	0,020	0,025	0,031
5,0			0,001	0,002	0,004	0,006	0,009	0,012	0,016	0,020	0,025
6,0				0,002	0,003	0,005	0,008	0,010	0,013	0,017	0,021
8,0				0,001	0,003	0,004	0,006	0,008	0,010	0,013	0,016
10,0				0,001	0,002	0,003	0,005	0,006	0,008	0,010	0,013
12,5				0,001	0,002	0,003	0,004	0,005	0,006	0,008	0,010

R	R _y	Feed rate									
		1,1	1,2	1,3	1,4	1,5	1,6	1,7	1,8	1,9	2,0
0,5											
1,0											
1,5		0,104									
2,0		0,077	0,092	0,109							
2,5		0,061	0,073	0,086	0,100						
3,0		0,051	0,061	0,071	0,083	0,095	0,109				
4,0		0,038	0,045	0,053	0,062	0,071	0,081	0,091	0,103		
5,0		0,030	0,036	0,042	0,049	0,057	0,064	0,073	0,082	0,091	0,101
6,0		0,025	0,030	0,035	0,041	0,047	0,054	0,061	0,068	0,076	0,084
8,0		0,019	0,023	0,026	0,031	0,035	0,040	0,045	0,051	0,057	0,063
10,0		0,015	0,018	0,021	0,025	0,028	0,032	0,036	0,041	0,045	0,050
12,5		0,012	0,014	0,017	0,020	0,023	0,026	0,029	0,032	0,036	0,040

Go directly to the special tool tailored for your milling applications

Are there milling applications at your company where having custom tools tailored to your unique needs would deliver real benefits both in terms of logistics and at a technical and commercial level? ZCC Cutting Tools Europe is there to advise and assist you during the planning, development and ordering process. Use our new online tool to request a special tool and get your personal quotation in just a few short steps (<https://www.zcct-europe.com/en/tools/special-tools>).

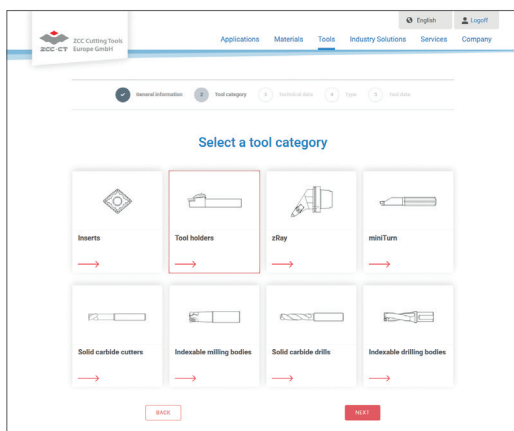

'Online tool for special tools' launch page where you can select the tool category

Selecting the tool category

Scan the QR code on this page to go directly to the launch page of our online tool where you can request the special tool you need. You can begin by selecting the tool category you need. It's that easy.

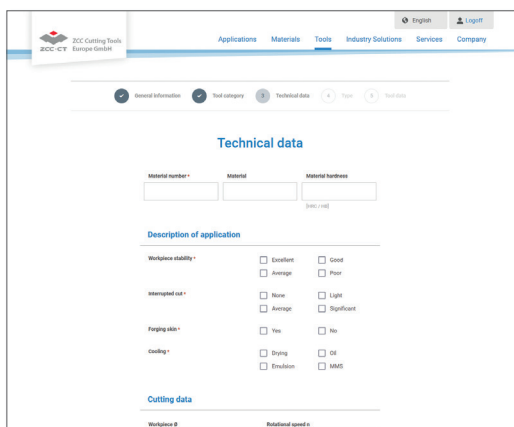

Define the relevant tool parameters.

Defining the tool parameters

You are now guided step by step through the process. You can also securely upload your drawings, diagrams and 3D models (where available).

It's the easy way to order your custom-made special tool from ZCC Cutting Tools Europe GmbH.



Now go directly to the new **special tool form** on our website and get started.

INDEXABLE DRILLS



Indexable drills

Product overview	C2
Chip breaker overview	C3-C4
Grade overview	C6-C7
Application fields of grades	C8
System code – drilling bodies	C9
Drilling bodies	C10-C31
ISO code – inserts	C32
Inserts	C33-C35
Recommended cutting data	C36-C37
Special tools	C214



A

Turning

B

Milling

C

Drilling

D

Technical
Information

E

Index

A

Turning

Indexable insert drill



ZD03	ZTD02	ZTD03	ZTD04	ZTD05	
16-58	13-50	13-73	13-59.5	17-50	Diameter
C30	C22	C24	C26	C28	Page

B

Milling



ZSD02	ZSD03	ZSD04	ZSD05	
12-63	12-63	12-63	12-63	Diameter
C10	C13	C16	C19	Page

C

Drilling

Drilling inserts



SPGT-EM	SPGT-PM	SPMX-EM	SPMX-LM	SPMX-XM	WCMX-53	WCMX-D	WCMX-PG	
05 06 07 09 11 14	05 06 07 09 11 14	04 05 06 07 09 11 14	04 05 06 07 09 11 14	04 05 06 07 09 11 14	03 04 05 06 08	06 08	03 04 05 06 08	Edge length
C34	C34	C33	C33	C33	C35	C35	C35	Page

D

Technical Information

E

Index

Drilling

XM **P** **M**



Single-sided chip breaker for medium machining operations. All-round geometry with excellent chip control for steel and cast iron.

LM **P** **M**



Single-sided chip breaker for medium machining operations. All-round geometry with excellent chip control for soft steel.

PM **P** **M** **K**



For machining of steel, stainless steel and cast iron.

EM **P** **M** **S**



For machining of steel, stainless steel and heat-resistant alloys.

PG **P** **K**



For machining of steel and cast iron.

D **P** **M** **K**



For machining of steel, stainless steel and cast iron.

A

Turning

B

Milling

C

Drilling

D

Technical Information

E

Index

A

Drilling

53

P M K N



Turning

For machining of steel, stainless steel, cast iron and non-ferrous metals.

B

Milling

C

Drilling



D

Technical
Information

E

Index

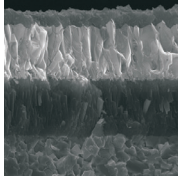
Coated cemented carbide CVD

Grade	ISO	Micro structure	Grade description
YB6338	P20 - P40 K20 - K40		CVD coated P20–P40/K20–K40 carbide substrate for operation with higher cutting speed and feed rate in steel and cast iron.
YBD252	K20 - K35		CVD coated K20–K35 carbide substrate. Optimized for medium to roughing operation of cast iron and Steel. Good wear resistance and toughness at higher cutting speed.

Coated cemented carbide PVD

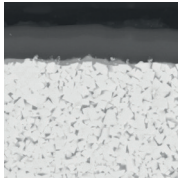
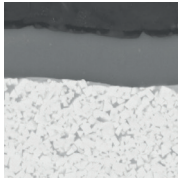
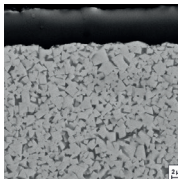
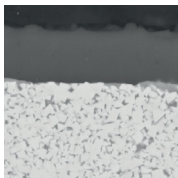
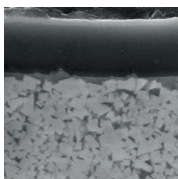
Grade	ISO	Micro structure	Grade description
YBG105	S05 - S20		PVD multilayer coated S05–S20 carbide substrate for finishing to medium application of super alloy material but also stainless steel. Good wear resistance and thermal stability in a wide application field.
YBG202	P10 - P30 M10 - M25		PVD coated M10–M25/P10–P30 carbide substrate for finishing to medium application of stainless steel and steel (milling). Good wear resistance in a wide application field.
YBS203	S15 - S25		For processing heat-resistant materials. A special carbon substrate and the latest PVD coating technology enable a very good wear behaviour, high fracture toughness and high thermal stability.
YBG205	P10 - P30 M20 - M40 S15-S25		PVD multilayer coated P10–P30/M20–M40/S15–S25 carbide substrate for finishing to medium machining of stainless steel, super alloys and steel (milling). Excellent wear resistance and thermal stability in a wide range of applications.
YB9320	P10 - P30 M10 - M25		PVD multilayer coated P10–P30/M10–M25 carbide substrate for finishing to medium machining of stainless steel, super alloys and steel (grooving/milling). Optimised coating stability for higher wear resistance and thermal stability in a wide range of applic

A

Turning

B

Milling

C

Drilling

D

Technical
Information

E

Index

Coated cemented carbide PVD

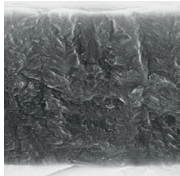
Grade	ISO	Micro structure	Grade description
YBG212	P25 - P35 M25-M40		PVD coated M25-M40/P25-P35 carbide substrate for steel and stainless steel. Especially for inner insert at drilling operation.

Uncoated cemented carbide

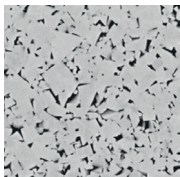
Grade	ISO	Micro structure	Grade description
YD201	K10 - K30 N10 - N30		Uncoated N10-N30/K10-K30 carbide substrate for medium application in aluminum and other material.

A

Turning

B

Milling

C

Drilling

DTechnical
Information**E**

Index

Application fields of grades – indexable drills

	ISO	HC ¹ (CVD)	HC ¹ (PVD)	HT	HW	PCBN & PCD
A Turning	P01					
	P10					
	P20	YBD252	YBG202			
	P30	YB6338	YBG205			
	P40		YBG212			
B Milling	M01					
	M10		YBG202			
	M20		YB9320			
	M30		YBG205			
	M40		YBS203			
C Drilling	K01					
	K10	YBD252	YBG202			
	K20	YB6338	YBG205			
	K30					
	K40					
D	N01					
	N10					
	N20				YD201	
	N30					
E Technical Information	S01		YBG202			
	S10		YB9320			
	S20		YBG205			
	S30		YBS203			
F Index	H01					
	H10					
	H20					
	H30					

P	Steel
M	Stainless steel
K	Cast iron

N	Non-ferrous alloys
S	Heat-resistant alloys
H	Hardened materials

HC¹ Coated cemented carbide
 HT Uncoated cermet
 HW Uncoated cemented carbide

ZSD – 03 300 – XP – 32 S P 09 – 02

1 2 3 4 5 6 7 8 9

Type	
Code	Description
ZSD	Indexable drill (SPMX*)
ZTD	Indexable drill (SPGT*)
ZD	Indexable drill (WCMX*)

1

L/D relation	
Code	Description
02	2xD
03	3xD
04	4xD
05	5xD

2

Diameter [mm]	
Code	Description
130	13
...	



3

Shank type	
Code	Description
XP	Weldon shank

4

Coupling size [mm]



5

Insert shape	
W	
S	

6

Clearance angle	
Code	Description
C	7°
P	11°

7

Cutting edge length [mm]		
Code	Insert shape	
	 W	 S
03	3,8	
04	4,3	
05	5,4	5
06	6,5	6
08	8,7	7,94
09		9,8
11		11,5
12		12,7
14		14,3

8

Number of teeth

9

A

Turning

B

Milling

C

Drilling

D

Technical Information

E

Index

Indexable drills series

ZSD02

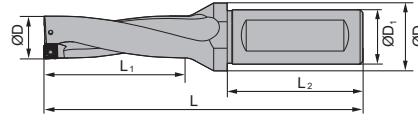

Article	*	Stock	Dimensions [mm]							kg	Inserts
			ØD	ØD1	ØD2	L1	L2	L			
ZSD02-120-XP20-SP04-02	*	•	12	20	25	27	50	94	0.162	SPMX040204**	
ZSD02-125-XP20-SP04-02	*	•	12.5	20	25	28	50	95	0.164	SPMX040204**	
ZSD02-130-XP20-SP04-02	*	•	13	20	25	29	50	96	0.167	SPMX040204**	
ZSD02-135-XP20-SP04-02	*	•	13.5	20	25	30	50	97	0.169	SPMX040204**	
ZSD02-140-XP20-SP04-02	*	•	14	20	25	31	50	98	0.172	SPMX040204**	
ZSD02-145-XP20-SP04-02	*	•	14.5	20	25	32	50	99	0.176	SPMX040204**	
ZSD02-150-XP20-SP05-02	*	•	15	20	25	33	50	100	0.179	SPMX050204**	
ZSD02-155-XP20-SP05-02	*	•	15.5	20	25	34	50	101	0.185	SPMX050204**	
ZSD02-160-XP20-SP05-02	*	•	16	20	25	35	50	102	0.189	SPMX050204**	
ZSD02-165-XP20-SP05-02	*	•	16.5	20	25	36	50	103	0.193	SPMX050204**	
ZSD02-170-XP20-SP05-02	*	•	17	20	25	37	50	104	0.201	SPMX050204**	
ZSD02-175-XP20-SP05-02	*	•	17.5	20	25	38	50	105	0.207	SPMX050204**	
ZSD02-180-XP25-SP06-02	*	•	18	25	32	39	56	113	0.304	SPMX060204**	
ZSD02-185-XP25-SP06-02	*	•	18.5	25	32	40	56	114	0.308	SPMX060204**	
ZSD02-190-XP25-SP06-02	*	•	19	25	32	41	56	115	0.313	SPMX060204**	
ZSD02-195-XP25-SP06-02	*	•	19.5	25	32	42	56	116	0.317	SPMX060204**	
ZSD02-200-XP25-SP06-02	*	•	20	25	32	43	56	117	0.323	SPMX060204**	
ZSD02-205-XP25-SP06-02	*	•	20.5	25	32	44	56	118	0.327	SPMX060204**	
ZSD02-210-XP25-SP06-02	*	•	21	25	32	45	56	119	0.33	SPMX060204**	
ZSD02-215-XP25-SP06-02	*	•	21.5	25	32	46	56	120	0.341	SPMX060204**	
ZSD02-220-XP25-SP06-02	*	•	22	25	32	47	56	121	0.346	SPMX060204**	
ZSD02-225-XP25-SP07-02	*	•	22.5	25	32	48	56	122	0.34	SPMX07T308**	
ZSD02-230-XP25-SP07-02	*	•	23	25	32	49	56	123	0.348	SPMX07T308**	
ZSD02-235-XP25-SP07-02	*	•	23.5	25	32	50	56	124	0.353	SPMX07T308**	
ZSD02-240-XP25-SP07-02	*	•	24	25	32	51	56	125	0.36	SPMX07T308**	
ZSD02-245-XP25-SP07-02	*	•	24.5	25	32	52	56	126	0.367	SPMX07T308**	
ZSD02-250-XP25-SP07-02	*	•	25	25	32	53	56	127	0.373	SPMX07T308**	
ZSD02-255-XP25-SP07-02	*	•	25.5	25	32	54	56	128	0.382	SPMX07T308**	
ZSD02-260-XP25-SP07-02	*	•	26	25	32	55	56	129	0.391	SPMX07T308**	
ZSD02-265-XP25-SP07-02	*	○	26.5	25	32	56	56	130	0.4	SPMX07T308**	
ZSD02-270-XP25-SP07-02	*	•	27	25	32	57	56	131	0.409	SPMX07T308**	
ZSD02-275-XP25-SP07-02	*	•	27.5	25	32	58	56	132	0.418	SPMX07T308**	
ZSD02-280-XP32-SP09-02	*	•	28	32	37	59	60	139	0.599	SPMX090408**	

• Ex stock ○ On demand



* Internal cooling

System code > C9

Grade selection > C8



Technical info > C201

Cutting data > C36

Article	*	Stock	Dimensions [mm]							Inserts 
			ØD	ØD1	ØD2	L1	L2	L		
ZSD02-290-XP32-SP09-02	*	●	29	32	37	60	60	141	0.619	SPMX090408**
ZSD02-300-XP32-SP09-02	*	●	30	32	37	61	60	143	0.64	SPMX090408**
ZSD02-310-XP32-SP09-02	*	●	31	32	37	65	60	145	0.663	SPMX090408**
ZSD02-320-XP32-SP09-02	*	●	32	32	37	67	60	147	0.687	SPMX090408**
ZSD02-330-XP32-SP09-02	*	●	33	32	37	69	60	149	0.713	SPMX090408**
ZSD02-340-XP40-SP11-02	*	●	34	40	47	71	70	166	1.101	SPMX110408**
ZSD02-350-XP40-SP11-02	*	●	35	40	47	73	70	168	1.136	SPMX110408**
ZSD02-360-XP40-SP11-02	*	●	36	40	47	75	70	170	1.166	SPMX110408**
ZSD02-370-XP40-SP11-02	*	●	37	40	47	77	70	172	1.202	SPMX110408**
ZSD02-380-XP40-SP11-02	*	●	38	40	47	79	70	174	1.235	SPMX110408**
ZSD02-390-XP40-SP11-02	*	●	39	40	47	81	70	176	1.271	SPMX110408**
ZSD02-400-XP40-SP11-02	*	●	40	40	47	83	70	178	1.311	SPMX110408**
ZSD02-410-XP40-SP11-02	*	●	41	40	47	85	70	180	1.347	SPMX110408**
ZSD02-420-XP40-SP11-02	*	○	42	40	52	87	70	189	1.491	SPMX140512**
ZSD02-430-XP40-SP14-02	*	○	43	40	52	89	70	191	1.496	SPMX140512**
ZSD02-440-XP40-SP14-02	*	○	44	40	52	91	70	193	1.499	SPMX140512**
ZSD02-450-XP40-SP14-02	*	○	45	40	52	93	70	195	1.535	SPMX140512**
ZSD02-460-XP40-SP14-02	*	○	46	40	52	95	70	197	1.562	SPMX140512**
ZSD02-470-XP40-SP14-02	*	○	47	40	52	97	70	199	1.644	SPMX140512**
ZSD02-480-XP40-SP14-02	*	○	48	40	52	99	70	201	1.697	SPMX140512**
ZSD02-490-XP40-SP14-02	*	○	49	40	52	102	70	203	1.757	SPMX140512**
ZSD02-500-XP40-SP14-02	*	○	50	40	52	103	70	205	1.817	SPMX140512**
ZSD02-510-XP50-SP14-02	*	○	51	50	57	105	80	217	2.46	SPMX140512**
ZSD02-520-XP50-SP14-02	*	○	52	50	57	107	80	219	2.527	SPMX140512**
ZSD02-530-XP50-SP14-02	*	○	53	50	57	109	80	221	2.594	SPMX140512**
ZSD02-540-XP50-SP09-04	*	○	54	50	57	111	80	223	2.612	SPMX090408**
ZSD02-550-XP50-SP09-04	*	○	55	50	57	113	80	225	2.673	SPMX090408**
ZSD02-560-XP50-SP09-04	*	○	56	50	57	115	80	227	2.747	SPMX090408**
ZSD02-570-XP50-SP09-04	*	○	57	50	57	117	80	229	2.816	SPMX090408**
ZSD02-580-XP50-SP09-04	*	○	58	50	57	119	80	231	2.889	SPMX090408**
ZSD02-590-XP50-SP09-04	*	○	59	50	57	121	80	233	2.967	SPMX090408**
ZSD02-600-XP50-SP09-04	*	○	60	50	57	123	80	235	3.115	SPMX090408**
ZSD02-610-XP50-SP09-04	*	○	61	50	57	125	80	237	3.195	SPMX090408**
ZSD02-620-XP50-SP09-04	*	○	62	50	57	127	80	239	3.285	SPMX090408**
ZSD02-630-XP50-SP09-04	*	○	63	50	57	129	80	241	3.368	SPMX090408**

● Ex stock ○ On demand

* Internal cooling

Spare parts		SPMX040204**	SPMX050204**	SPMX060204**	SPMX07T308**	SPMX090408**	SPMX110408**	SPMX140512**
	Insert Screw	I60M1.8x4 (0.5Nm)	I60M2x4.3 (0.5Nm)	I60M2.2x5.5 (0.8Nm)	I60M2.5x6.5 (1.0Nm)	I60M3.5x8 (2.7Nm)	I60M4x10 (3.4Nm)	I60M5x13 (6.7Nm)
	Wrench	WT05IP	WT06IP	WT07IP	WT07IP	WT15IP	WT15IP	WT20IP

System code > C9

Grade selection > C8

Technical info > C201

Cutting data > C36



A

Turning

B

Milling

C

Drilling

D

Technical Information

E

Index

A

Turning

Insert



C33

B

Milling

C

Drilling

D

Technical
Information

E

Index

System code > C9

Grade selection > C8

Technical info > C201

Cutting data > C36

Indexable drills series

ZSD03

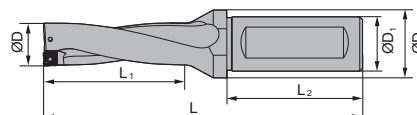

Article	*	Stock	Dimensions [mm]							kg	Inserts
			ØD	ØD1	ØD2	L1	L2	L			
ZSD03-120-XP20-SP04-02	*	●	12	20	25	39	50	105	0.165	SPMX040204**	
ZSD03-125-XP20-SP04-02	*	●	12.5	20	25	41	50	107	0.169	SPMX040204**	
ZSD03-130-XP20-SP04-02	*	●	13	20	25	42	50	108	0.171	SPMX040204**	
ZSD03-135-XP20-SP04-02	*	●	13.5	20	25	44	50	110	0.175	SPMX040204**	
ZSD03-140-XP20-SP04-02	*	●	14	20	25	45	50	111	0.178	SPMX040204**	
ZSD03-145-XP20-SP04-02	*	●	14.5	20	25	47	50	113	0.182	SPMX040204**	
ZSD03-150-XP20-SP05-02	*	●	15	20	25	48	50	114	0.189	SPMX050204**	
ZSD03-155-XP20-SP05-02	*	●	15.5	20	25	50	50	116	0.192	SPMX050204**	
ZSD03-160-XP20-SP05-02	*	●	16	20	25	51	50	117	0.201	SPMX050204**	
ZSD03-165-XP20-SP05-02	*	●	16.5	20	25	53	50	119	0.203	SPMX050204**	
ZSD03-170-XP20-SP05-02	*	●	17	20	25	54	50	120	0.205	SPMX050204**	
ZSD03-175-XP20-SP05-02	*	●	17.5	20	25	56	50	122	0.206	SPMX050204**	
ZSD03-180-XP25-SP06-02	*	●	18	25	32	57	56	131	0.319	SPMX060204**	
ZSD03-185-XP25-SP06-02	*	●	18.5	25	32	59	56	133	0.326	SPMX060204**	
ZSD03-190-XP25-SP06-02	*	●	19	25	32	60	56	134	0.332	SPMX060204**	
ZSD03-195-XP25-SP06-02	*	●	19.5	25	32	62	56	136	0.339	SPMX060204**	
ZSD03-200-XP25-SP06-02	*	●	20	25	32	63	56	137	0.344	SPMX060204**	
ZSD03-205-XP25-SP06-02	*	●	20.5	25	32	65	56	139	0.352	SPMX060204**	
ZSD03-210-XP25-SP06-02	*	●	21	25	32	66	56	140	0.368	SPMX060204**	
ZSD03-215-XP25-SP06-02	*	●	21.5	25	32	68	56	142	0.37	SPMX060204**	
ZSD03-220-XP25-SP06-02	*	●	22	25	32	69	56	143	0.375	SPMX060204**	
ZSD03-225-XP25-SP07-02	*	●	22.5	25	32	71	56	145	0.397	SPMX07T308**	
ZSD03-230-XP25-SP07-02	*	●	23	25	32	72	56	147	0.383	SPMX07T308**	
ZSD03-235-XP25-SP07-02	*	●	23.5	25	32	74	56	149	0.395	SPMX07T308**	
ZSD03-240-XP25-SP07-02	*	●	24	25	32	75	56	150	0.406	SPMX07T308**	
ZSD03-245-XP25-SP07-02	*	●	24.5	25	32	77	56	152	0.423	SPMX07T308**	
ZSD03-250-XP25-SP07-02	*	●	25	25	32	78	56	153	0.431	SPMX07T308**	
ZSD03-255-XP25-SP07-02	*	●	25.5	25	32	80	56	155	0.44	SPMX07T308**	
ZSD03-260-XP25-SP07-02	*	●	26	25	32	81	56	156	0.453	SPMX07T308**	
ZSD03-265-XP25-SP07-02	*	●	26.5	25	32	83	56	158	0.467	SPMX07T308**	
ZSD03-270-XP25-SP07-02	*	●	27	25	32	84	56	160	0.504	SPMX07T308**	
ZSD03-275-XP25-SP07-02	*	●	27.5	25	32	86	56	162	0.682	SPMX07T308**	
ZSD03-280-XP32-SP09-02	*	●	28	32	37	87	60	169	0.707	SPMX090408**	

● Ex stock ○ On demand

* Internal cooling

System code > C9

Grade selection > C8

Technical info > C201

Cutting data > C36



Indexable drills Drilling bodies

A

Turning

B

Milling

C

Drilling

D

Technical Information

E



Index

Article	*	Stock	Dimensions [mm]							kg	Inserts 
			ØD	ØD1	ØD2	L1	L2	L			
ZSD03-290-XP32-SP09-02	*	•	29	32	37	90	60	172	0.739	SPMX090408**	
ZSD03-300-XP32-SP09-02	*	•	30	32	37	93	60	175	0.754	SPMX090408**	
ZSD03-310-XP32-SP09-02	*	•	31	32	37	96	60	178	0.771	SPMX090408**	
ZSD03-320-XP32-SP09-02	*	•	32	32	37	99	60	181	0.806	SPMX090408**	
ZSD03-330-XP32-SP09-02	*	•	33	32	37	102	60	184	0.847	SPMX090408**	
ZSD03-340-XP40-SP11-02	*	•	34	40	47	105	70	200	1.208	SPMX110408**	
ZSD03-350-XP40-SP11-02	*	•	35	40	47	108	70	203	1.248	SPMX110408**	
ZSD03-360-XP40-SP11-02	*	•	36	40	47	111	70	206	1.302	SPMX110408**	
ZSD03-370-XP40-SP11-02	*	•	37	40	47	114	70	209	1.341	SPMX110408**	
ZSD03-380-XP40-SP11-02	*	•	38	40	47	117	70	212	1.395	SPMX110408**	
ZSD03-390-XP40-SP11-02	*	•	39	40	47	120	70	215	1.447	SPMX110408**	
ZSD03-400-XP40-SP11-02	*	•	40	40	47	123	70	218	1.505	SPMX110408**	
ZSD03-410-XP40-SP11-02	*	•	41	40	47	126	70	221	1.549	SPMX110408**	
ZSD03-420-XP40-SP11-02	*	○	42	40	52	129	70	231	1.716	SPMX140512**	
ZSD03-430-XP40-SP14-02	*	•	43	40	52	132	70	234	1.656	SPMX140512**	
ZSD03-440-XP40-SP14-02	*	○	44	40	52	135	70	237	1.708	SPMX140512**	
ZSD03-450-XP40-SP14-02	*	○	45	40	52	138	70	240	1.776	SPMX140512**	
ZSD03-460-XP40-SP14-02	*	○	46	40	52	141	70	243	1.851	SPMX140512**	
ZSD03-470-XP40-SP14-02	*	○	47	40	52	144	70	245	1.924	SPMX140512**	
ZSD03-480-XP40-SP14-02	*	○	48	40	52	147	70	249	2.003	SPMX140512**	
ZSD03-490-XP40-SP14-02	*	○	49	40	52	150	70	252	2.094	SPMX140512**	
ZSD03-500-XP40-SP14-02	*	○	50	40	52	153	70	255	2.184	SPMX140512**	
ZSD03-510-XP50-SP14-02	*	○	51	50	57	156	80	268	2.882	SPMX140512**	
ZSD03-520-XP50-SP14-02	*	○	52	50	57	159	80	271	2.974	SPMX140512**	
ZSD03-530-XP50-SP14-02	*	○	53	50	57	162	80	274	3.071	SPMX140512**	
ZSD03-540-XP50-SP09-04	*	○	54	50	57	165	80	277	3.116	SPMX090408**	
ZSD03-550-XP50-SP09-04	*	○	55	50	57	168	80	280	3.208	SPMX090408**	
ZSD03-560-XP50-SP09-04	*	○	56	50	57	171	80	283	3.315	SPMX090408**	
ZSD03-570-XP50-SP09-04	*	○	57	50	57	174	80	286	3.499	SPMX090408**	
ZSD03-580-XP50-SP09-04	*	○	58	50	57	177	80	289	3.53	SPMX090408**	
ZSD03-590-XP50-SP09-04	*	○	59	50	57	180	80	292	3.649	SPMX090408**	
ZSD03-600-XP50-SP09-04	*	○	60	50	57	183	80	295	3.838	SPMX090408**	
ZSD03-610-XP50-SP09-04	*	○	61	50	57	186	80	298	3.961	SPMX090408**	
ZSD03-620-XP50-SP09-04	*	○	62	50	57	189	80	301	4.103	SPMX090408**	
ZSD03-630-XP50-SP09-04	*	○	63	50	57	192	80	304	4.238	SPMX090408**	

• Ex stock ○ On demand

* Internal cooling

Spare parts

Insert	SPMX040204**	SPMX050204**	SPMX060204**	SPMX07T308**	SPMX090408**	SPMX110408**	SPMX140512**
 Screw	I60M1.8x4 (0.5Nm)	I60M2x4.3 (0.5Nm)	I60M2.2x5.5 (0.8Nm)	I60M2.5x6.5 (1.0Nm)	I60M3.5x8 (2.7Nm)	I60M4x10 (3.4Nm)	I60M5x13 (6.7Nm)
 Wrench	WT05IP	WT06IP	WT07IP	WT07IP	WT15IP	WT15IP	WT20IP

System code > C9

Grade selection > C8

Technical info > C201

Cutting data > C36

Insert



C33

A

Turning

B

Milling

C

Drilling

D

Technical
Information

E

Index

System code > C9

Grade selection > C8

Technical info > C201

Cutting data > C36



Indexable drills series

ZSD04

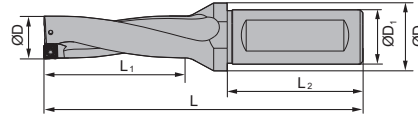

Article	*	Stock	Dimensions [mm]							kg	Inserts
			ØD	ØD1	ØD2	L1	L2	L			
ZSD04-120-XP20-SP04-02	*	•	12	20	25	51	50	117	0.169	SPMX040204**	
ZSD04-125-XP20-SP04-02	*	•	12.5	20	25	53	50	119	0.173	SPMX040204**	
ZSD04-130-XP20-SP04-02	*	•	13	20	25	55	50	121	0.177	SPMX040204**	
ZSD04-135-XP20-SP04-02	*	•	13.5	20	25	57	50	123	0.181	SPMX040204**	
ZSD04-140-XP20-SP04-02	*	•	14	20	25	59	50	125	0.186	SPMX040204**	
ZSD04-145-XP20-SP04-02	*	•	14.5	20	25	61	50	127	0.191	SPMX040204**	
ZSD04-150-XP20-SP05-02	*	•	15	20	25	63	50	129	0.2	SPMX050204**	
ZSD04-155-XP20-SP05-02	*	•	15.5	20	25	65	50	131	0.203	SPMX050204**	
ZSD04-160-XP20-SP05-02	*	•	16	20	25	67	50	133	0.207	SPMX050204**	
ZSD04-165-XP20-SP05-02	*	•	16.5	20	25	69	50	135	0.214	SPMX050204**	
ZSD04-170-XP20-SP05-02	*	•	17	20	25	71	50	137	0.218	SPMX050204**	
ZSD04-175-XP20-SP05-02	*	•	17.5	20	25	73	50	139	0.222	SPMX050204**	
ZSD04-180-XP25-SP06-02	*	•	18	25	32	75	56	149	0.34	SPMX060204**	
ZSD04-185-XP25-SP06-02	*	•	18.5	25	32	77	56	151	0.341	SPMX060204**	
ZSD04-190-XP25-SP06-02	*	•	19	25	32	79	56	153	0.369	SPMX060204**	
ZSD04-195-XP25-SP06-02	*	•	19.5	25	32	81	56	155	0.382	SPMX060204**	
ZSD04-200-XP25-SP06-02	*	•	20	25	32	83	56	157	0.367	SPMX060204**	
ZSD04-205-XP25-SP06-02	*	•	20.5	25	32	85	56	159	0.37	SPMX060204**	
ZSD04-210-XP25-SP06-02	*	•	21	25	32	87	56	161	0.413	SPMX060204**	
ZSD04-215-XP25-SP06-02	*	•	21.5	25	32	89	56	163	0.426	SPMX060204**	
ZSD04-220-XP25-SP06-02	*	•	22	25	32	91	56	165	0.441	SPMX060204**	
ZSD04-225-XP25-SP07-02	*	•	22.5	25	32	93	56	167	0.407	SPMX07T308**	
ZSD04-230-XP25-SP07-02	*	•	23	25	32	95	56	170	0.421	SPMX07T308**	
ZSD04-235-XP25-SP07-02	*	•	23.5	25	32	97	56	172	0.483	SPMX07T308**	
ZSD04-240-XP25-SP07-02	*	•	24	25	32	99	56	174	0.502	SPMX07T308**	
ZSD04-245-XP25-SP07-02	*	•	24.5	25	32	101	56	176	0.517	SPMX07T308**	
ZSD04-250-XP25-SP07-02	*	•	25	25	32	103	56	178	0.52	SPMX07T308**	
ZSD04-255-XP25-SP07-02	*	•	25.5	25	32	105	56	181	0.5	SPMX07T308**	
ZSD04-260-XP25-SP07-02	*	•	26	25	32	107	56	182	0.512	SPMX07T308**	
ZSD04-265-XP25-SP07-02	*	•	26.5	25	32	109	56	184	0.52	SPMX07T308**	
ZSD04-270-XP25-SP07-02	*	•	27	25	32	111	56	187	0.617	SPMX07T308**	
ZSD04-275-XP25-SP07-02	*	•	27.5	25	32	113	56	190	0.642	SPMX07T308**	
ZSD04-280-XP32-SP09-02	*	○	28	32	37	115	60	199	0.748	SPMX090408**	

• Ex stock ○ On demand



* Internal cooling

System code > C9

Grade selection > C8



Technical info > C201

Cutting data > C36

Article	*	Stock	Dimensions [mm]							Inserts 
			ØD	ØD1	ØD2	L1	L2	L		
ZSD04-290-XP32-SP09-02	*	●	29	32	37	119	60	203	0.793	SPMX090408**
ZSD04-300-XP32-SP09-02	*	●	30	32	37	123	60	207	0.832	SPMX090408**
ZSD04-305-XP32-SP09-02	*	●	30.5	32	37	125	60	209	0.854	SPMX090408**
ZSD04-310-XP32-SP09-02	*	●	31	32	37	127	60	211	0.872	SPMX090408**
ZSD04-320-XP32-SP09-02	*	●	32	32	37	131	60	215	0.922	SPMX090408**
ZSD04-330-XP32-SP09-02	*	●	33	32	37	135	60	219	0.973	SPMX090408**
ZSD04-340-XP40-SP11-02	*	●	34	40	47	139	70	234	1.326	SPMX110408**
ZSD04-350-XP40-SP11-02	*	●	35	40	47	143	70	238	1.384	SPMX110408**
ZSD04-360-XP40-SP11-02	*	●	36	40	47	147	70	242	1.445	SPMX110408**
ZSD04-370-XP40-SP11-02	*	●	37	40	47	151	70	246	1.499	SPMX110408**
ZSD04-380-XP40-SP11-02	*	●	38	40	47	155	70	250	1.563	SPMX110408**
ZSD04-390-XP40-SP11-02	*	●	39	40	47	159	70	254	1.629	SPMX110408**
ZSD04-400-XP40-SP11-02	*	●	40	40	47	163	70	258	1.697	SPMX110408**
ZSD04-405-XP40-SP11-02	*	●	40.5	40	47	165	70	260	1.737	SPMX110408**
ZSD04-410-XP40-SP11-02	*	●	41	40	47	167	70	262	1.775	SPMX110408**
ZSD04-420-XP40-SP11-02	*	○	42	40	52	171	70	273	1.948	SPMX140512**
ZSD04-430-XP40-SP14-02	*	○	43	40	52	175	70	277	1.952	SPMX140512**
ZSD04-440-XP40-SP14-02	*	○	44	40	52	179	70	281	1.962	SPMX140512**
ZSD04-450-XP40-SP14-02	*	○	45	40	52	183	70	285	2.06	SPMX140512**
ZSD04-460-XP40-SP14-02	*	○	46	40	52	187	70	289	2.157	SPMX140512**
ZSD04-470-XP40-SP14-02	*	●	47	40	52	191	70	293	2.256	SPMX140512**
ZSD04-480-XP40-SP14-02	*	○	48	40	52	195	70	297	2.361	SPMX140512**
ZSD04-490-XP40-SP14-02	*	○	49	40	52	199	70	301	2.489	SPMX140512**
ZSD04-500-XP40-SP14-02	*	○	50	40	52	203	70	305	2.589	SPMX140512**
ZSD04-510-XP50-SP14-02	*	○	51	50	57	207	80	319	3.292	SPMX140512**
ZSD04-520-XP50-SP14-02	*	○	52	50	57	211	80	323	3.435	SPMX140512**
ZSD04-530-XP50-SP14-02	*	○	53	50	57	215	80	327	3.574	SPMX140512**
ZSD04-540-XP50-SP09-04	*	○	54	50	57	219	80	331	3.604	SPMX090408**
ZSD04-550-XP50-SP09-04	*	○	55	50	57	223	80	335	3.731	SPMX090408**
ZSD04-560-XP50-SP09-04	*	○	56	50	57	227	80	339	3.868	SPMX090408**
ZSD04-570-XP50-SP09-04	*	○	57	50	57	231	80	343	4.01	SPMX090408**
ZSD04-580-XP50-SP09-04	*	○	58	50	57	235	80	347	4.156	SPMX090408**
ZSD04-590-XP50-SP09-04	*	○	59	50	57	239	80	351	4.312	SPMX090408**
ZSD04-600-XP50-SP09-04	*	○	60	50	57	243	80	355	4.558	SPMX090408**
ZSD04-610-XP50-SP09-04	*	○	61	50	57	247	80	359	4.72	SPMX090408**
ZSD04-620-XP50-SP09-04	*	○	62	50	57	251	80	363	4.886	SPMX090408**
ZSD04-630-XP50-SP09-04	*	○	63	50	57	255	80	367	5.068	SPMX090408**

● Ex stock ○ On demand

* Internal cooling

Spare parts								
	Insert	SPMX040204**	SPMX050204**	SPMX060204**	SPMX07T308**	SPMX090408**	SPMX110408**	SPMX140512**
	Screw	I60M1.8x4 (0.5Nm)	I60M2x4.3 (0.5Nm)	I60M2.2x5.5 (0.8Nm)	I60M2.5x6.5 (1.0Nm)	I60M3.5x8 (2.7Nm)	I60M4x10 (3.4Nm)	I60M5x13 (6.7Nm)
	Wrench	WT05IP	WT06IP	WT07IP	WT07IP	WT15IP	WT15IP	WT20IP

System code > C9

Grade selection > C8

Technical info > C201

Cutting data > C36



A

Turning

B

Milling

C

Drilling

D

Technical Information

E

Index

A

Insert



C33

Turning

B

Milling

C

Drilling

D

Technical
Information

E

Index

System code > C9

Grade selection > C8

Technical info > C201

Cutting data > C36

Indexable drills series

ZSD05

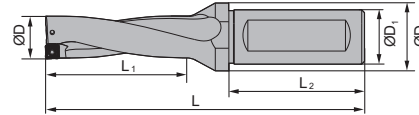

Article	*	Stock	Dimensions [mm]							kg	Inserts
			ØD	ØD1	ØD2	L1	L2	L			
ZSD05-120-XP20-SP04-02	*	●	12	20	25	63	50	129	0.173	SPMX040204**	
ZSD05-125-XP20-SP04-02	*	●	12.5	20	25	66	50	132	0.179	SPMX040204**	
ZSD05-130-XP20-SP04-02	*	●	13	20	25	68	50	134	0.183	SPMX040204**	
ZSD05-135-XP20-SP04-02	*	●	13.5	20	25	71	50	137	0.189	SPMX040204**	
ZSD05-140-XP20-SP04-02	*	●	14	20	25	73	50	139	0.194	SPMX040204**	
ZSD05-145-XP20-SP04-02	*	●	14.5	20	25	76	50	141	0.2	SPMX040204**	
ZSD05-150-XP20-SP05-02	*	●	15	20	25	78	50	144	0.206	SPMX050204**	
ZSD05-155-XP20-SP05-02	*	●	15.5	20	25	81	50	147	0.214	SPMX050204**	
ZSD05-160-XP20-SP05-02	*	●	16	20	25	83	50	149	0.219	SPMX050204**	
ZSD05-165-XP20-SP05-02	*	●	16.5	20	25	86	50	152	0.223	SPMX050204**	
ZSD05-170-XP20-SP05-02	*	●	17	20	25	88	50	154	0.23	SPMX050204**	
ZSD05-175-XP20-SP05-02	*	●	17.5	20	25	91	50	157	0.239	SPMX050204**	
ZSD05-180-XP25-SP06-02	*	●	18	25	32	93	56	167	0.355	SPMX060204**	
ZSD05-185-XP25-SP06-02	*	●	18.5	25	32	96	56	170	0.36	SPMX060204**	
ZSD05-190-XP25-SP06-02	*	●	19	25	32	98	56	172	0.369	SPMX060204**	
ZSD05-195-XP25-SP06-02	*	●	19.5	25	32	101	56	175	0.382	SPMX060204**	
ZSD05-200-XP25-SP06-02	*	●	20	25	32	103	56	177	0.39	SPMX060204**	
ZSD05-205-XP25-SP06-02	*	●	20.5	25	32	106	56	180	0.401	SPMX060204**	
ZSD05-210-XP25-SP06-02	*	●	21	25	32	108	56	182	0.413	SPMX060204**	
ZSD05-215-XP25-SP06-02	*	●	21.5	25	32	111	56	185	0.426	SPMX060204**	
ZSD05-220-XP25-SP06-02	*	●	22	25	32	113	56	187	0.441	SPMX060204**	
ZSD05-225-XP25-SP07-02	*	●	22.5	25	32	116	56	190	0.442	SPMX07T308**	
ZSD05-230-XP25-SP07-02	*	●	23	25	32	118	56	194	0.461	SPMX07T308**	
ZSD05-235-XP25-SP07-02	*	●	23.5	25	32	121	56	197	0.483	SPMX07T308**	
ZSD05-240-XP25-SP07-02	*	●	24	25	32	123	56	199	0.497	SPMX07T308**	
ZSD05-245-XP25-SP07-02	*	●	24.5	25	32	126	56	202	0.517	SPMX07T308**	
ZSD05-250-XP25-SP07-02	*	●	25	25	32	128	56	204	0.533	SPMX07T308**	
ZSD05-255-XP25-SP07-02	*	●	25.5	25	32	131	56	207	0.555	SPMX07T308**	
ZSD05-260-XP25-SP07-02	*	●	26	25	32	133	56	209	0.571	SPMX07T308**	
ZSD05-265-XP25-SP07-02	*	●	26.5	25	32	136	56	212	0.593	SPMX07T308**	
ZSD05-270-XP25-SP07-02	*	●	27	25	32	138	56	214	0.617	SPMX07T308**	
ZSD05-275-XP25-SP07-02	*	●	27.5	25	32	141	56	217	0.642	SPMX07T308**	
ZSD05-280-XP32-SP09-02	*	●	28	32	37	143	60	223	0.791	SPMX090408**	

● Ex stock ○ On demand

* Internal cooling

System code > C9

Grade selection > C8

Technical info > C201

Cutting data > C36



A

Turning

B

Milling

C

Drilling

D

Technical Information

E

Index

Indexable drills Drilling bodies

A

Turning

B

Milling

C

Drilling

D

Technical Information

E



Index

Article	*	Stock	Dimensions [mm]							kg	Inserts 
			ØD	ØD1	ØD2	L1	L2	L			
ZSD05-290-XP32-SP09-02	*	•	29	32	37	148	60	228	0.837	SPMX090408**	
ZSD05-300-XP32-SP09-02	*	•	30	32	37	153	60	233	0.943	SPMX090408**	
ZSD05-310-XP32-SP09-02	*	•	31	32	37	158	60	238	0.943	SPMX090408**	
ZSD05-320-XP32-SP09-02	*	•	32	32	37	163	60	243	1.001	SPMX090408**	
ZSD05-330-XP32-SP09-02	*	•	33	32	37	168	60	249	1.067	SPMX090408**	
ZSD05-340-XP40-SP11-02	*	•	34	40	47	173	70	268	1.44	SPMX110408**	
ZSD05-350-XP40-SP11-02	*	•	35	40	47	178	70	273	1.505	SPMX110408**	
ZSD05-360-XP40-SP11-02	*	•	36	40	47	183	70	278	1.575	SPMX110408**	
ZSD05-370-XP40-SP11-02	*	•	37	40	47	188	70	283	1.723	SPMX110408**	
ZSD05-380-XP40-SP11-02	*	•	38	40	47	193	70	288	1.723	SPMX110408**	
ZSD05-390-XP40-SP11-02	*	•	39	40	47	198	70	293	1.808	SPMX110408**	
ZSD05-400-XP40-SP11-02	*	•	40	40	47	203	70	298	1.894	SPMX110408**	
ZSD05-410-XP40-SP11-02	*	•	41	40	47	208	70	303	1.991	SPMX110408**	
ZSD05-420-XP40-SP11-02	*	○	42	40	52	213	70	315	2.182	SPMX140512**	
ZSD05-430-XP40-SP14-02	*	•	43	40	52	218	70	320	2.11	SPMX140512**	
ZSD05-440-XP40-SP14-02	*	•	44	40	52	223	70	325	2.22	SPMX140512**	
ZSD05-450-XP40-SP14-02	*	•	45	40	52	228	70	330	2.331	SPMX140512**	
ZSD05-460-XP40-SP14-02	*	•	46	40	52	233	70	335	2.45	SPMX140512**	
ZSD05-470-XP40-SP14-02	*	○	47	40	52	238	70	340	2.582	SPMX140512**	
ZSD05-480-XP40-SP14-02	*	•	48	40	52	243	70	345	2.693	SPMX140512**	
ZSD05-490-XP40-SP14-02	*	•	19	40	52	248	70	350	2.823	SPMX140512**	
ZSD05-500-XP40-SP14-02	*	•	50	40	52	253	70	355	2.958	SPMX140512**	
ZSD05-510-XP50-SP14-02	*	○	51	50	57	258	80	370	3.7	SPMX140512**	
ZSD05-520-XP50-SP14-02	*	○	52	50	57	263	80	375	3.848	SPMX140512**	
ZSD05-530-XP50-SP14-02	*	○	53	50	57	268	80	380	3.998	SPMX140512**	
ZSD05-540-XP50-SP09-04	*	○	54	50	57	273	80	385	4.035	SPMX090408**	
ZSD05-550-XP50-SP09-04	*	○	55	50	57	278	80	390	4.203	SPMX090408**	
ZSD05-560-XP50-SP09-04	*	○	56	50	57	283	80	395	4.368	SPMX090408**	
ZSD05-570-XP50-SP09-04	*	○	57	50	57	288	80	400	4.671	SPMX090408**	
ZSD05-580-XP50-SP09-04	*	○	58	50	57	293	80	405	4.866	SPMX090408**	
ZSD05-590-XP50-SP09-04	*	○	59	50	57	298	80	410	5.047	SPMX090408**	
ZSD05-600-XP50-SP09-04	*	○	60	50	57	303	80	415	5.192	SPMX090408**	
ZSD05-610-XP50-SP09-04	*	○	61	50	57	308	80	420	5.4	SPMX090408**	
ZSD05-620-XP50-SP09-04	*	○	62	50	57	313	80	425	5.619	SPMX090408**	
ZSD05-630-XP50-SP09-04	*	○	63	50	57	318	80	430	5.834	SPMX090408**	

• Ex stock ○ On demand

* Internal cooling

Spare parts

Insert	SPMX040204**	SPMX050204**	SPMX060204**	SPMX07T308**	SPMX090408**	SPMX110408**	SPMX140512**
 Screw	I60M1.8x4 (0.5Nm)	I60M2x4.3 (0.5Nm)	I60M2.2x5.5 (0.8Nm)	I60M2.5x6.5 (1.0Nm)	I60M3.5x8 (2.7Nm)	I60M4x10 (3.4Nm)	I60M5x13 (6.7Nm)
 Wrench	WT05IP	WT06IP	WT07IP	WT07IP	WT15IP	WT15IP	WT20IP

System code > C9

Grade selection > C8

Technical info > C201

Cutting data > C36

Insert



C33

A

Turning

B

Milling

C

Drilling

D

Technical
Information

E

Index

System code > C9

Grade selection > C8

Technical info > C201

Cutting data > C36



Indexable drills series

ZTD02

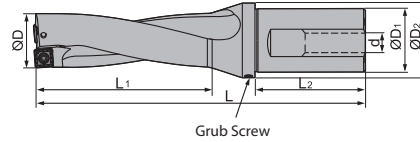

Article	*	Stock	Dimensions [mm]								kg	Inserts
			ØD	ØD1	ØD2	L1	L2	L	d			
ZTD02-130-XP20-SP05-02	*	•	13	20	25	31	50	98	M13×1	0.165	SPGT0502**	
ZTD02-140-XP20-SP05-02	*	•	14	20	25	33	50	100	M13×1	0.171	SPGT0502**	
ZTD02-150-XP20-SP05-02	*	•	15	20	25	35	50	102	M13×1	0.176	SPGT0502**	
ZTD02-160-XP20-SP05-02	*	•	16	20	25	37	50	104	M13×1	0.184	SPGT0502**	
ZTD02-170-XP25-SP06-02	*	•	17	25	32	39	56	117	M16×1,5	0.325	SPGT0602**	
ZTD02-180-XP25-SP06-02	*	•	18	25	32	41	56	119	M16×1,5	0.332	SPGT0602**	
ZTD02-190-XP25-SP06-02	*	•	19	25	32	43	56	121	M16×1,5	0.342	SPGT0602**	
ZTD02-200-XP25-SP06-02	*	•	20	25	32	45	56	123	M16×1,5	0.353	SPGT0602**	
ZTD02-210-XP25-SP06-02	*	•	21	25	32	47	56	125	M16×1,5	0.35	SPGT0602**	
ZTD02-220-XP25-SP07-02	*	•	22	25	32	49	56	127	M16×1,5	0.367	SPGT07T3**	
ZTD02-230-XP25-SP07-02	*	•	23	25	32	51	56	129	M16×1,5	0.38	SPGT07T3**	
ZTD02-235-XP25-SP07-02	*	○	23.5	25	32	52	56	130	M16×1,5	0.361	SPGT07T3**	
ZTD02-240-XP25-SP07-02	*	•	24	25	32	53	56	131	M16×1,5	0.443	SPGT07T3**	
ZTD02-250-XP25-SP07-02	*	•	25	25	32	55	56	133	M16×1,5	0.41	SPGT07T3**	
ZTD02-260-XP25-SP07-02	*	•	26	25	32	57	56	135	M16×1,5	0.454	SPGT07T3**	
ZTD02-270-XP25-SP07-02	*	•	27	25	32	59	56	137	M16×1,5	0.445	SPGT07T3**	
ZTD02-280-XP32-SP09-02	*	•	28	32	37	61	60	146	M22×2	0.661	SPGT0904**	
ZTD02-290-XP32-SP09-02	*	•	29	32	37	63	60	148	M22×2	0.682	SPGT0904**	
ZTD02-300-XP32-SP09-02	*	•	30	32	37	65	60	150	M22×2	0.702	SPGT0904**	
ZTD02-310-XP32-SP09-02	*	•	31	32	37	67	60	152	M22×2	0.759	SPGT0904**	
ZTD02-320-XP32-SP09-02	*	•	32	32	37	69	60	154	M22×2	0.742	SPGT0904**	
ZTD02-330-XP32-SP09-02	*	•	33	32	37	71	60	156	M22×2	0.774	SPGT0904**	
ZTD02-340-XP40-SP11-02	*	•	34	40	47	73	70	173	(BSPT)RC1/4	1.2	SPGT1104**	
ZTD02-350-XP40-SP11-02	*	•	35	40	47	75	70	175	(BSPT)RC1/4	1.23	SPGT1104**	
ZTD02-360-XP40-SP11-02	*	•	36	40	47	77	70	177	(BSPT)RC1/4	1.26	SPGT1104**	
ZTD02-370-XP40-SP11-02	*	•	37	40	47	79	70	179	(BSPT)RC1/4	1.29	SPGT1104**	
ZTD02-380-XP40-SP11-02	*	•	38	40	47	81	70	181	(BSPT)RC1/4	1.33	SPGT1104**	
ZTD02-390-XP40-SP11-02	*	•	39	40	47	83	70	183	(BSPT)RC1/4	1.39	SPGT1104**	
ZTD02-400-XP40-SP11-02	*	•	40	40	47	85	70	185	(BSPT)RC1/4	1.43	SPGT1104**	
ZTD02-410-XP40-SP11-02	*	•	41	40	47	87	70	187	(BSPT)RC1/4	1.44	SPGT1104**	
ZTD02-420-XP40-SP14-02	*	•	42	40	52	89	70	199	(BSPT)RC1/4	1.62	SPGT1405**	
ZTD02-430-XP40-SP14-02	*	•	43	40	52	91	70	201	(BSPT)RC1/4	1.67	SPGT1405**	
ZTD02-440-XP40-SP14-02	*	•	44	40	52	93	70	203	(BSPT)RC1/4	1.71	SPGT1405**	

• Ex stock ○ On demand

* Internal cooling

System code > C9

Grade selection > C8



Technical info > C201

Cutting data > C36

Article	*	Stock	Dimensions [mm]								kg	Inserts 
			ØD	ØD1	ØD2	L1	L2	L	d			
ZTD02-450-XP40-SP14-02	*	•	45	40	52	95	70	205	(BSPT)RC1/4	1.76	SPGT1405**	
ZTD02-460-XP40-SP14-02	*	•	46	40	52	97	70	207	(BSPT)RC1/4	1.81	SPGT1405**	
ZTD02-470-XP40-SP14-02	*	•	47	40	52	99	70	209	(BSPT)RC1/4	1.87	SPGT1405**	
ZTD02-480-XP40-SP14-02	*	•	48	40	52	101	70	211	(BSPT)RC1/4	1.92	SPGT1405**	
ZTD02-490-XP40-SP14-02	*	•	49	40	52	103	70	213	(BSPT)RC1/4	1.98	SPGT1405**	
ZTD02-500-XP40-SP14-02	*	•	50	40	52	105	70	215	(BSPT)RC1/4	2.05	SPGT1405**	

• Ex stock ○ On demand

* Internal cooling

Spare parts							
Insert	SPGT0502**	SPGT0602**	SPGT07T3**	SPGT0904**	SPGT1104**	SPGT1405**	
 Grub screw					M6×6 (7.0Nm)	M8×8 (10.2Nm)	
 Screw	I60M2×4.3 (0.5Nm)	I60M2.2×5.5 (0.8Nm)	I60M2.5×6.5 (1.0Nm)	I60M3.5×8 (2.7Nm)	I60M4×10 (3.4Nm)	I60M5×13 (6.7Nm)	
 Wrench	WT06IP	WT07IP	WT07IP	WT15IP	WT15IP	WT20IP	

Insert



C34

A

Turning

B

Milling

C

Drilling

D

Technical Information

E

Index

System code > C9

Grade selection > C8

Technical info > C201

Cutting data > C36



Indexable drills series

ZTD03

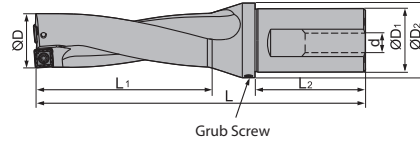

Grub Screw

Article	*	Stock	Dimensions [mm]								kg	Inserts
			ØD	ØD1	ØD2	L1	L2	L	d			
ZTD03-130-XP20-SP05-02	*	•	13	20	25	44	50	111	M13×1	0.179	SPGT0502**	
ZTD03-140-XP20-SP05-02	*	•	14	20	25	47	50	114	M13×1	0.186	SPGT0502**	
ZTD03-150-XP20-SP05-02	*	•	15	20	25	50	50	117	M13×1	0.195	SPGT0502**	
ZTD03-160-XP20-SP05-02	*	•	16	20	25	53	50	120	M13×1	0.214	SPGT0502**	
ZTD03-170-XP25-SP06-02	*	•	17	25	32	56	56	134	M16×1,5	0.32	SPGT0602**	
ZTD03-180-XP25-SP06-02	*	•	18	25	32	59	56	137	M16×1,5	0.331	SPGT0602**	
ZTD03-190-XP25-SP06-02	*	•	19	25	32	62	56	140	M16×1,5	0.342	SPGT0602**	
ZTD03-200-XP25-SP06-02	*	•	20	25	32	65	56	143	M16×1,5	0.356	SPGT0602**	
ZTD03-210-XP25-SP06-02	*	•	21	25	32	68	56	146	M16×1,5	0.391	SPGT0602**	
ZTD03-220-XP25-SP07-02	*	•	22	25	32	71	56	149	M16×1,5	0.391	SPGT07T3**	
ZTD03-230-XP25-SP07-02	*	•	23	25	32	74	56	152	M16×1,5	0.442	SPGT07T3**	
ZTD03-240-XP25-SP07-02	*	•	24	25	32	77	56	155	M16×1,5	0.485	SPGT07T3**	
ZTD03-250-XP25-SP07-02	*	•	25	25	32	80	56	158	M16×1,5	0.492	SPGT07T3**	
ZTD03-260-XP25-SP07-02	*	•	26	25	32	83	56	161	M16×1,5	0.497	SPGT07T3**	
ZTD03-270-XP25-SP07-02	*	•	27	25	32	86	56	164	M16×1,5	0.521	SPGT07T3**	
ZTD03-280-XP32-SP09-02	*	•	28	32	37	89	60	174	M22×2	0.75	SPGT0904**	
ZTD03-285-XP32-SP09-02	*	○	28.5	32	37	91	60	171	M22×2	0.699	SPGT0904**	
ZTD03-290-XP32-SP09-02	*	•	29	32	37	92	60	177	M22×2	0.777	SPGT0904**	
ZTD03-300-XP32-SP09-02	*	•	30	32	37	95	60	180	M22×2	0.81	SPGT0904**	
ZTD03-310-XP32-SP09-02	*	•	31	32	37	98	60	183	M22×2	0.831	SPGT0904**	
ZTD03-320-XP32-SP09-02	*	•	32	32	37	101	60	186	M22×2	0.867	SPGT0904**	
ZTD03-330-XP32-SP09-02	*	•	33	32	37	104	60	189	M22×2	0.928	SPGT0904**	
ZTD03-340-XP40-SP11-02	*	•	34	40	47	107	70	207	(BSPT)RC1/4	1.33	SPGT1104**	
ZTD03-350-XP40-SP11-02	*	•	35	40	47	110	70	210	(BSPT)RC1/4	1.371	SPGT1104**	
ZTD03-360-XP40-SP11-02	*	•	36	40	47	113	70	213	(BSPT)RC1/4	1.414	SPGT1104**	
ZTD03-370-XP40-SP11-02	*	•	37	40	47	116	70	216	(BSPT)RC1/4	1.448	SPGT1104**	
ZTD03-380-XP40-SP11-02	*	•	38	40	47	119	70	219	(BSPT)RC1/4	1.498	SPGT1104**	
ZTD03-390-XP40-SP11-02	*	•	39	40	47	122	70	222	(BSPT)RC1/4	1.554	SPGT1104**	
ZTD03-400-XP40-SP11-02	*	•	40	40	47	125	70	225	(BSPT)RC1/4	1.667	SPGT1104**	
ZTD03-410-XP40-SP11-02	*	•	41	40	47	128	70	228	(BSPT)RC1/4	1.653	SPGT1104**	
ZTD03-420-XP40-SP14-02	*	•	42	40	52	131	70	241	(BSPT)RC1/4	1.903	SPGT1405**	
ZTD03-430-XP40-SP14-02	*	•	43	40	52	134	70	244	(BSPT)RC1/4	1.951	SPGT1405**	
ZTD03-440-XP40-SP14-02	*	•	44	40	52	137	70	247	(BSPT)RC1/4	2.039	SPGT1405**	

• Ex stock ○ On demand

* Internal cooling

System code > C9

Grade selection > C8

Technical info > C201



Cutting data > C36

Article	*	Stock	Dimensions [mm]								kg	Inserts 
			ØD	ØD1	ØD2	L1	L2	L	d			
ZTD03-450-XP40-SP14-02	*	●	45	40	52	140	70	250	(BSPT)RC1/4	2.12	SPGT1405**	
ZTD03-460-XP40-SP14-02	*	●	46	40	52	143	70	253	(BSPT)RC1/4	2.186	SPGT1405**	
ZTD03-470-XP40-SP14-02	*	●	47	40	52	146	70	256	(BSPT)RC1/4	2.264	SPGT1405**	
ZTD03-480-XP40-SP14-02	*	●	48	40	52	149	70	259	(BSPT)RC1/4	2.341	SPGT1405**	
ZTD03-490-XP40-SP14-02	*	●	49	40	52	152	70	262	(BSPT)RC1/4	2.43	SPGT1405**	
ZTD03-500-XP40-SP14-02	*	●	50	40	52	155	70	265	(BSPT)RC1/4	2.52	SPGT1405**	
ZTD03-508-XP40-SP14-02	*	○	50.8	40	57	157	70	267	(BSPT)RC1/4	2.484	SPGT1405**	
ZTD03-510-XP50-SP07-04	*	○	51	50	62	158	80	278	(BSPT)RC1/4	3.128	SPGT07T3**	
ZTD03-530-XP50-SP07-04	*	○	53	50	62	164	80	284	(BSPT)RC1/4	3.426	SPGT07T3**	
ZTD03-540-XP50-SP09-04	*	○	54	50	57	167	80	287	(BSPT)RC1/4	3.292	SPGT0904**	
ZTD03-550-XP50-SP09-04	*	○	55	50	57	170	80	290	(BSPT)RC1/4	3.29	SPGT0904**	
ZTD03-570-XP50-SP09-04	*	○	57	50	67	176	80	296	(BSPT)RC1/4	3.853	SPGT0904**	
ZTD03-580-XP50-SP09-04	*	○	58	50	62	179	80	299	(BSPT)RC1/4	3.851	SPGT0904**	
ZTD03-590-XP50-SP09-04	*	○	59	50	62	182	80	302	(BSPT)RC1/4	3.814	SPGT0904**	
ZTD03-600-XP50-SP09-04	*	○	60	50	67	185	80	305	(BSPT)RC1/4	4.217	SPGT0904**	
ZTD03-620-XP50-SP09-04	*	○	62	50	67	191	80	311	(BSPT)RC1/4	4.454	SPGT0904**	
ZTD03-630-XP50-SP09-04	*	○	63	50	67	194	80	314	(BSPT)RC1/4	4.6	SPGT0904**	
ZTD03-640-XP50-SP09-04	*	○	64	50	67	197	80	317	(BSPT)RC1/4	4.574	SPGT0904**	
ZTD03-650-XP50-SP09-04	*	○	65	50	67	200	80	320	(BSPT)RC1/4	4.882	SPGT0904**	
ZTD03-660-XP50-SP09-04	*	○	66	50	67	203	80	323	(BSPT)RC1/4	5.024	SPGT0904**	
ZTD03-670-XP50-SP11-04	*	○	67	50	82	206	80	326	(BSPT)RC1/4	5.181	SPGT1104**	
ZTD03-730-XP50-SP11-04	*	○	73	50	85	224	80	344	(BSPT)RC1/4	6.71	SPGT1104**	

● Ex stock ○ On demand

* Internal cooling

Spare parts

	Insert	SPGT0502**	SPGT0602**	SPGT07T3**	SPGT0904**	SPGT1104**	SPGT1405**
	Grub screw					M6×6 (7.0Nm)	M8×8 (10.2Nm)
	Screw	I60M2×4.3 (0.5Nm)	I60M2.2×5.5 (0.8Nm)	I60M2.5×6.5 (1.0Nm)	I60M3.5×8 (2.7Nm)	I60M4×10 (3.4Nm)	I60M5×13 (6.7Nm)
	Wrench	WT06IP	WT07IP	WT07IP	WT15IP	WT15IP	WT20IP

Insert



C34

System code > C9

Grade selection > C8

Technical info > C201

Cutting data > C36

Indexable drills series

ZTD04

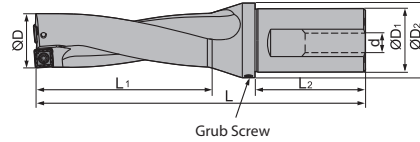

Article	*	Stock	Dimensions [mm]								kg	Inserts
			ØD	ØD1	ØD2	L1	L2	L	d			
ZTD04-130-XP20-SP05-02	*	o	13	20	25	57	50	124	M13x1	0.185	SPGT0502**	
ZTD04-140-XP20-SP05-02	*	o	14	20	25	61	50	128	M13x1	0.195	SPGT0502**	
ZTD04-150-XP20-SP05-02	*	o	15	20	25	65	50	132	M13x1	0.205	SPGT0502**	
ZTD04-160-XP20-SP05-02	*	o	16	20	25	69	50	136	M13x1	0.216	SPGT0502**	
ZTD04-165-XP25-SP06-02	*	o	16.5	25	32	71	56	137	M16x1,5	0.332	SPGT0602**	
ZTD04-170-XP25-SP06-02	*	o	17	25	32	73	56	151	M16x1,5	0.333	SPGT0602**	
ZTD04-180-XP25-SP06-02	*	o	18	25	32	77	56	155	M16x1,5	0.347	SPGT0602**	
ZTD04-190-XP25-SP06-02	*	o	19	25	32	81	56	159	M16x1,5	0.362	SPGT0602**	
ZTD04-200-XP25-SP06-02	*	o	20	25	32	85	56	163	M16x1,5	0.381	SPGT0602**	
ZTD04-210-XP25-SP06-02	*	o	21	25	32	89	56	167	M16x1,5	0.4	SPGT0602**	
ZTD04-215-XP25-SP07-02	*	o	21.5	25	32	91	56	165	M16x1,5	0.407	SPGT07T3**	
ZTD04-220-XP25-SP07-02	*	o	22	25	32	93	56	171	M16x1,5	0.391	SPGT07T3**	
ZTD04-230-XP25-SP07-02	*	o	23	25	32	97	56	175	M16x1,5	0.484	SPGT07T3**	
ZTD04-240-XP25-SP07-02	*	o	24	25	32	101	56	179	M16x1,5	0.513	SPGT07T3**	
ZTD04-250-XP25-SP07-02	*	o	25	25	32	105	56	183	M16x1,5	0.494	SPGT07T3**	
ZTD04-260-XP25-SP07-02	*	o	26	25	32	109	56	187	M16x1,5	0.535	SPGT07T3**	
ZTD04-270-XP25-SP07-02	*	o	27	25	32	113	56	191	M16x1,5	0.582	SPGT07T3**	
ZTD04-275-XP25-SP07-02	*	o	27.5	25	32	115	56	192	M16x1,5	0.571	SPGT07T3**	
ZTD04-280-XP32-SP09-02	*	o	28	32	37	117	60	202	M22x2	0.653	SPGT0904**	
ZTD04-290-XP32-SP09-02	*	o	29	32	37	121	60	206	M22x2	0.846	SPGT0904**	
ZTD04-300-XP32-SP09-02	*	o	30	32	37	125	60	210	M22x2	0.893	SPGT0904**	
ZTD04-310-XP32-SP09-02	*	o	31	32	37	129	60	214	M22x2	0.914	SPGT0904**	
ZTD04-320-XP32-SP09-02	*	o	32	32	37	133	60	218	M22x2	0.966	SPGT0904**	
ZTD04-330-XP32-SP09-02	*	o	33	32	37	137	60	222	M22x2	1.016	SPGT0904**	
ZTD04-340-XP40-SP11-02	*	o	34	40	47	141	70	241	(BSPT)RC1/4	1.46	SPGT1104**	
ZTD04-350-XP40-SP11-02	*	o	35	40	47	145	70	245	(BSPT)RC1/4	1.52	SPGT1104**	
ZTD04-360-XP40-SP11-02	*	o	36	40	47	149	70	249	(BSPT)RC1/4	1.579	SPGT1104**	
ZTD04-370-XP40-SP11-02	*	o	37	40	47	153	70	253	(BSPT)RC1/4	1.592	SPGT1104**	
ZTD04-380-XP40-SP11-02	*	o	38	40	47	157	70	257	(BSPT)RC1/4	1.801	SPGT1104**	
ZTD04-390-XP40-SP11-02	*	o	39	40	47	161	70	261	(BSPT)RC1/4	1.801	SPGT1104**	
ZTD04-400-XP40-SP11-02	*	o	40	40	47	165	70	265	(BSPT)RC1/4	1.874	SPGT1104**	
ZTD04-410-XP40-SP11-02	*	o	41	40	47	169	70	269	(BSPT)RC1/4	1.861	SPGT1104**	
ZTD04-420-XP40-SP14-02	*	o	42	40	52	173	70	283	(BSPT)RC1/4	2.168	SPGT1405**	

● Ex stock ○ On demand

* Internal cooling

System code > C9

Grade selection > C8

Technical info > C201



Cutting data > C36

Article	*	Stock	Dimensions [mm]								kg	Inserts 
			ØD	ØD1	ØD2	L1	L2	L	d			
ZTD04-430-XP40-SP14-02	*	○	43	40	52	177	70	287	(BSPT)RC1/4	2.17	SPGT1405**	
ZTD04-440-XP40-SP14-02	*	○	44	40	52	181	70	291	(BSPT)RC1/4	2.31	SPGT1405**	
ZTD04-450-XP40-SP14-02	*	○	45	40	52	185	70	295	(BSPT)RC1/4	2.421	SPGT1405**	
ZTD04-460-XP40-SP14-02	*	○	46	40	52	189	70	299	(BSPT)RC1/4	2.507	SPGT1405**	
ZTD04-470-XP40-SP14-02	*	○	47	40	52	193	70	303	(BSPT)RC1/4	2.612	SPGT1405**	
ZTD04-480-XP40-SP14-02	*	○	48	40	52	197	70	307	(BSPT)RC1/4	2.66	SPGT1405**	
ZTD04-490-XP40-SP14-02	*	○	49	40	52	201	70	311	(BSPT)RC1/4	2.836	SPGT1405**	
ZTD04-500-XP40-SP14-02	*	○	50	40	52	205	70	315	(BSPT)RC1/4	2.954	SPGT1405**	
ZTD04-520-XP50-SP07-04	*	○	52	50	62	213	80	325	(BSPT)RC1/4	3.685	SPGT07T3**	
ZTD04-530-XP50-SP07-04	*	○	53	50	62	217	80	329	(BSPT)RC1/4	3.777	SPGT07T3**	
ZTD04-540-XP50-SP09-04	*	○	54	50	57	222	80	333	(BSPT)RC1/4	3.906	SPGT0904**	
ZTD04-545-XP50-SP09-04	*	○	54.5	50	68	221	80	335	(BSPT)RC1/4	4.167	SPGT0904**	
ZTD04-595-XP50-SP09-04	*	○	59.5	50	68	241	80	355	(BSPT)RC1/4	4.784	SPGT0904**	

● Ex stock ○ On demand

* Internal cooling

Spare parts

	Insert	SPGT0502**	SPGT0602**	SPGT07T3**	SPGT0904**	SPGT1104**	SPGT1405**
	Grub screw					M6×6 (7.0Nm)	M8×8 (10.2Nm)
	Screw	I60M2×4.3 (0.5Nm)	I60M2.2×5.5 (0.8Nm)	I60M2.5×6.5 (1.0Nm)	I60M3.5×8 (2.7Nm)	I60M4×10 (3.4Nm)	I60M5×13 (6.7Nm)
	Wrench	WT06IP	WT07IP	WT07IP	WT15IP	WT15IP	WT20IP

Insert



C34

System code > C9

Grade selection > C8

Technical info > C201

Cutting data > C36

Indexable drills series

ZTD05

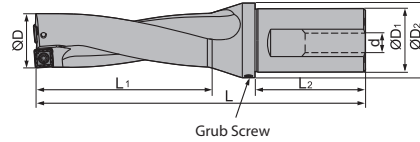

Grub Screw

Article	*	Stock	Dimensions [mm]								kg	Inserts
			ØD	ØD1	ØD2	L1	L2	L	d			
ZTD05-170-XP25-SP06-02	*	o	17	25	32	90	56	168	M13x1	0.374	SPGT0602**	
ZTD05-180-XP25-SP06-02	*	o	18	25	32	95	56	173	M13x1	0.394	SPGT0602**	
ZTD05-190-XP25-SP06-02	*	o	19	25	32	100	56	178	M13x1	0.415	SPGT0602**	
ZTD05-200-XP25-SP06-02	*	o	20	25	32	105	56	183	M13x1	0.44	SPGT0602**	
ZTD05-210-XP25-SP06-02	*	o	21	25	32	110	56	188	M16x1,5	0.466	SPGT0602**	
ZTD05-220-XP25-SP07-02	*	o	22	25	32	115	56	193	M16x1,5	0.476	SPGT07T3**	
ZTD05-230-XP25-SP07-02	*	o	23	25	32	120	56	198	M16x1,5	0.507	SPGT07T3**	
ZTD05-240-XP25-SP07-02	*	o	24	25	32	125	56	203	M16x1,5	0.542	SPGT07T3**	
ZTD05-250-XP25-SP07-02	*	o	25	25	32	130	56	208	M16x1,5	0.561	SPGT07T3**	
ZTD05-260-XP25-SP07-02	*	o	26	25	32	135	56	213	M16x1,5	0.613	SPGT07T3**	
ZTD05-270-XP25-SP07-02	*	o	27	25	32	140	56	218	M16x1,5	0.665	SPGT07T3**	
ZTD05-280-XP32-SP09-02	*	o	28	32	37	145	60	230	M16x1,5	0.891	SPGT0904**	
ZTD05-290-XP32-SP09-02	*	o	29	32	37	150	60	235	M16x1,5	0.965	SPGT0904**	
ZTD05-300-XP32-SP09-02	*	o	30	32	37	155	60	240	M16x1,5	0.959	SPGT0904**	
ZTD05-310-XP32-SP09-02	*	o	31	32	37	160	60	245	M16x1,5	1.042	SPGT0904**	
ZTD05-320-XP32-SP09-02	*	o	32	32	37	165	60	250	M22x2	1.11	SPGT0904**	
ZTD05-330-XP32-SP09-02	*	o	33	32	37	170	60	255	M22x2	1.117	SPGT0904**	
ZTD05-340-XP40-SP11-02	*	o	34	40	47	175	70	275	M22x2	1.57	SPGT1104**	
ZTD05-350-XP40-SP11-02	*	o	35	40	47	180	70	280	M22x2	1.65	SPGT1104**	
ZTD05-360-XP40-SP11-02	*	o	36	40	47	185	70	285	M22x2	1.712	SPGT1104**	
ZTD05-370-XP40-SP11-02	*	o	37	40	47	190	70	290	M22x2	1.802	SPGT1104**	
ZTD05-380-XP40-SP11-02	*	o	38	40	47	195	70	295	(BSPT)RC1/4	1.873	SPGT1104**	
ZTD05-390-XP40-SP11-02	*	o	39	40	47	200	70	300	(BSPT)RC1/4	1.962	SPGT1104**	
ZTD05-400-XP40-SP11-02	*	o	40	40	47	205	70	305	(BSPT)RC1/4	2.068	SPGT1104**	
ZTD05-410-XP40-SP11-02	*	o	41	40	47	210	70	310	(BSPT)RC1/4	2.167	SPGT1104**	
ZTD05-420-XP40-SP14-02	*	o	42	40	52	215	70	325	(BSPT)RC1/4	2.39	SPGT1405**	
ZTD05-430-XP40-SP14-02	*	o	43	40	52	220	70	330	(BSPT)RC1/4	2.502	SPGT1405**	
ZTD05-440-XP40-SP14-02	*	o	44	40	52	225	70	335	(BSPT)RC1/4	2.612	SPGT1405**	
ZTD05-450-XP40-SP14-02	*	o	45	40	52	230	70	340	(BSPT)RC1/4	2.733	SPGT1405**	
ZTD05-460-XP40-SP14-02	*	o	46	40	52	235	70	345	(BSPT)RC1/4	2.854	SPGT1405**	
ZTD05-470-XP40-SP14-02	*	o	47	40	52	240	70	350	(BSPT)RC1/4	2.894	SPGT1405**	
ZTD05-480-XP40-SP14-02	*	o	48	40	52	245	70	355	(BSPT)RC1/4	3.109	SPGT1405**	
ZTD05-490-XP40-SP14-02	*	o	49	40	52	250	70	360	(BSPT)RC1/4	3.271	SPGT1405**	
ZTD05-500-XP40-SP14-02	*	o	50	40	52	255	70	365	(BSPT)RC1/4	3.425	SPGT1405**	

• Ex stock o On demand

* Internal cooling

System code > C9

Grade selection > C8

Technical info > C201

Cutting data > C36

A

Turning

B

Milling

C

Drilling



D

Technical Information

E

Index

Spare parts

	Insert	SPGT0602**	SPGT07T3**	SPGT0904**	SPGT1104**	SPGT1405**
	Grub screw				M6×6 (7.0Nm)	M8×8 (10.2Nm)
	Screw	I60M2.2×5.5 (0.8Nm)	I60M2.5×6.5 (1.0Nm)	I60M3.5×8 (2.7Nm)	I60M4×10 (3.4Nm)	I60M5×13 (6.7Nm)
	Wrench	WT07IP	WT07IP	WT15IP	WT15IP	WT20IP

Insert



C34

System code > C9

Grade selection > C8

Technical info > C201

Cutting data > C36

Indexable drills series

ZD03

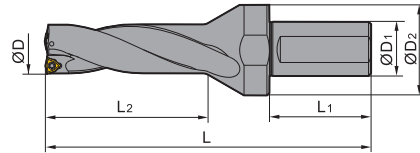
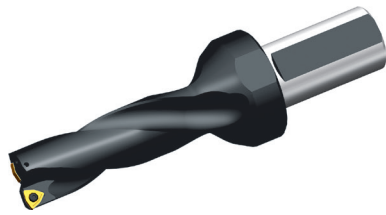

Article	*	Stock	Dimensions [mm]							kg	Inserts
			ØD	ØD1	ØD2	L1	L2	L			
ZD03-160-XP25-WC03-02	*	●	16	25	32	56	52	129	0.33	WCMX0302**	
ZD03-170-XP25-WC03-02	*	●	17	25	32	56	55	133	0.33	WCMX0302**	
ZD03-180-XP25-WC03-02	*	●	18	25	32	56	58	137	0.35	WCMX0302**	
ZD03-190-XP25-WC03-02	*	●	19	25	32	56	61	140	0.36	WCMX0302**	
ZD03-200-XP25-WC03-02	*	●	20	25	32	56	64	143	0.37	WCMX0302**	
ZD03-210-XP25-WC04-02	*	●	21	25	45	56	67	153	0.51	WCMX0402**	
ZD03-220-XP25-WC04-02	*	●	22	25	45	56	70	156	0.54	WCMX0402**	
ZD03-230-XP25-WC04-02	*	●	23	25	45	56	73	159	0.55	WCMX0402**	
ZD03-240-XP25-WC04-02	*	●	24	25	45	56	76	162	0.57	WCMX0402**	
ZD03-250-XP25-WC04-02	*	●	25	25	45	56	79	165	0.6	WCMX0402**	
ZD03-260-XP32-WC05-02	*	●	26	32	55	60	83	176	0.93	WCMX0503**	
ZD03-270-XP32-WC05-02	*	●	27	32	55	60	86	180	0.97	WCMX0503**	
ZD03-280-XP32-WC05-02	*	●	28	32	55	60	89	184	1.01	WCMX0503**	
ZD03-290-XP32-WC05-02	*	●	29	32	55	60	92	188	1.05	WCMX0503**	
ZD03-300-XP32-WC05-02	*	●	30	32	55	60	95	192	1.08	WCMX0503**	
ZD03-310-XP40-WC06-02	*	●	31	40	60	70	98	203	1.44	WCMX06T3**	
ZD03-320-XP40-WC06-02	*	●	32	40	60	70	101	206	1.48	WCMX06T3**	
ZD03-330-XP40-WC06-02	*	●	33	40	60	70	104	209	1.52	WCMX06T3**	
ZD03-340-XP40-WC06-02	*	●	34	40	60	70	107	212	1.55	WCMX06T3**	
ZD03-350-XP40-WC06-02	*	●	35	40	60	70	110	215	1.61	WCMX06T3**	
ZD03-360-XP40-WC06-02	*	●	36	40	60	70	113	218	1.66	WCMX06T3**	
ZD03-370-XP40-WC06-02	*	●	37	40	60	70	116	221	1.71	WCMX06T3**	
ZD03-380-XP40-WC06-02	*	●	38	40	60	70	119	225	1.76	WCMX06T3**	
ZD03-390-XP40-WC06-02	*	●	39	40	60	70	122	228	1.82	WCMX06T3**	
ZD03-400-XP40-WC06-02	*	●	40	40	60	70	125	231	1.93	WCMX06T3**	
ZD03-410-XP40-WC06-02	*	●	41	40	60	70	128	234	1.94	WCMX06T3**	
ZD03-420-XP40-WC08-02	*	●	42	40	60	70	131	239	2.18	WCMX0804**	
ZD03-430-XP40-WC08-02	*	●	43	40	60	70	134	242	2.245	WCMX0804**	
ZD03-440-XP40-WC08-02	*	●	44	40	60	70	137	245	2.34	WCMX0804**	
ZD03-450-XP40-WC08-02	*	●	45	40	60	70	140	248	2.34	WCMX0804**	
ZD03-460-XP40-WC08-02	*	●	46	40	60	70	143	251	2.49	WCMX0804**	
ZD03-470-XP40-WC08-02	*	●	47	40	60	70	146	253	2.88	WCMX0804**	
ZD03-480-XP40-WC08-02	*	●	48	40	70	70	149	255	2.55	WCMX0804**	

● Ex stock ○ On demand

* Internal cooling

System code > C9

Grade selection > C8



Technical info > C201

Cutting data > C36

Article	*	Stock	Dimensions [mm]							kg	Inserts 
			ØD	ØD1	ØD2	L1	L2	L			
ZD03-490-XP40-WC08-02	*	○	49	40	70	70	152	257	2.619	WCMX0804**	
ZD03-500-XP40-WC08-02	*	●	50	40	70	70	155	259	2.62	WCMX0804**	
ZD03-510-XP40-WC08-02	*	○	51	40	70	70	158	261	2.62	WCMX0804**	
ZD03-520-XP40-WC08-02	*	○	52	40	70	70	70	263	2.808	WCMX0804**	
ZD03-530-XP40-WC08-02	*	○	53	40	70	70	164	265	2.906	WCMX0804**	
ZD03-540-XP40-WC08-02	*	●	54	40	70	70	167	267	2.983	WCMX0804**	
ZD03-550-XP40-WC08-02	*	○	55	40	70	70	170	269	3.126	WCMX0804**	
ZD03-560-XP40-WC08-02	*	○	56	40	70	70	173	271	3.157	WCMX0804**	
ZD03-580-XP40-WC08-02	*	●	58	40	70	70	179	275	3.501	WCMX0804**	

● Ex stock ○ On demand

* Internal cooling

Spare parts						
	Insert	WCMX0302**	WCMX0402**	WCMX0503**	WCMX06T3**	WCMX0804**
	Screw	I60M2.5×6.5 (1.0Nm)	I60M2.5×6.5T (1.0Nm)	I60M3×7 (1.8Nm)	I60M3×7 (1.8Nm)	I60M3.5×10.4 (2.7Nm)
	Wrench	WT06IP	WT07IP	WT15IP	WT15IP	WT20IP

Insert



Medium Cut
C35

System code > C9

Grade selection > C8

Technical info > C201

Cutting data > C36



A

Turning

B

Milling

C

Drilling

D

Technical Information

E

Index

W C M X 08 04 12 R – PG

1 2 3 4 5 6 7 8 9

A

Turning

B

Milling

C



Drilling

D



Technical Information

E



Index

Insert shape	
W	
S	

1

Clearance angle	
C	
P	

2

Tolerance class			
			
Code	I.C [mm]	m [mm]	S [mm]
G	±0,025	±0,025	±0,130
M	±0,05-0,13	±0,08-0,18	±0,130

3

Fastening features (metric)	
Insert shape	
T	
X	Special

4

Cutting edge length l [mm]		
I.C [mm]	Insert shape	
	S	W
3,8		03
4,3		04
5,4		05
6,35	06	
6,5		06
8,0		08
8,7	08	
9,252	09	
12,7	12	

5

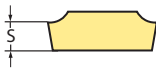
Insert thickness S [mm]			
			
Code	S	Code	S
00	0,79	05	5,56
T0	0,99	T5	5,95
01	1,59	06	6,35
T1	1,98	T6	6,75
02	2,38	07	7,94
T2	2,58	09	9,52
03	3,18	T9	9,72
T3	3,97	11	11,11
04	4,76	12	12,70
T4	4,96		

6

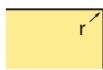
Nose radius r [mm]	
	
Code	r
04	0,4
08	0,8
12	1,2

7

Rotation direction	
Code	Description
R	Right
L	Left

8

Chip breaker overview (on page C3)

9

SPMX	L	I.C	S	d
04 02	4	4	2.38	2.2
05 02	5	5	2.38	2.2
06 02	6	6	2.38	2.5
07 T3	7.94	7.94	3.97	2.8
09 04	9.8	9.8	4.3	4.1
11 04	11.5	11.5	4.76	4.4
14 05	14.3	14.3	5.2	5.5

- Ideal machining conditions
- Normal machining conditions
- Unfavourable machining conditions

Drilling inserts

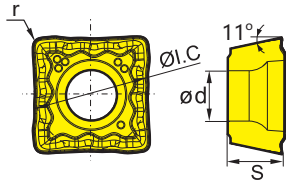

SP** milling insert			HC ¹ (CVD)	HC ¹ (PVD)	HW
	P				
	M				
	K				
	N				
	S				
	H				
ISO		r	YB6338 YBD252	YBG105 YBG202 YBS203 YBG205 YB9320 YBG212	YD201
	SPMX040203-EM	0.3	●	●	
	SPMX050204-EM	0.4	●	●	
	SPMX060204-EM	0.4	●	●	
	SPMX07T308-EM	0.8	●	●	
	SPMX090408-EM	0.8	●	●	
	SPMX110408-EM	0.8	●	●	
	SPMX140512-EM	1.2	●	●	
	SPMX040203-LM	0.3		○	
	SPMX050204-LM	0.4		○	
	SPMX060204-LM	0.4		○	
	SPMX07T308-LM	0.8		○	
	SPMX090408-LM	0.8		○	
	SPMX110408-LM	0.8		○	
	SPMX140512-LM	1.2		○	
	SPMX040203-XM	0.3		○	
	SPMX050204-XM	0.4		●	
	SPMX060204-XM	0.4		●	
	SPMX07T308-XM	0.8		●	○
	SPMX090408-XM	0.8		●	
	SPMX110408-XM	0.8		●	
	SPMX140512-XM	1.2		●	

● Ex stock ○ On demand

HC¹ Coated carbide
HW Uncoated carbide

Tool holder

ZSD02	ZSD03	ZSD04	ZSD05
C10	C13	C16	C19

System code > C32

Grade selection > C8

Technical info > C201

Cutting data > C36



A

Turning

B

Milling

C

Drilling



D

Technical Information











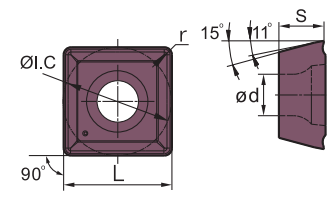







































E

Index

SPGT	L	I.C	S	d
05 02	5	5	2.38	2.2
06 02	6	6	2.38	2.6
07 T3	7.94	7.94	3.97	2.8
09 04	9.8	9.8	4.76	4.2
11 04	11.5	11.5	4.76	4.4
14 05	14.3	14.3	5.2	5.75





-  Ideal machining conditions
-  Normal machining conditions
-  Unfavourable machining conditions

Drilling inserts

SP** drilling insert			HC ¹ (CVD)	HC ¹ (PVD)	HW
	P		 	   	
	M			    	
	K				
	N				
	S			   	
	H				
ISO		r	YB6338 YBD252	YBG105 YBG202 YBS203 YBG205 YB9320 YBG212	YD201
	SPGT050204-PM	0.4		 	
	SPGT060204-PM	0.4		 	
	SPGT07T308-PM	0.8		 	
	SPGT090408-PM	0.8		 	
	SPGT110408-PM	0.8		 	
	SPGT140512-PM	1.2		 	
	SPGT050204-EM	0.4		 	
	SPGT060204-EM	0.4		 	
	SPGT07T308-EM	0.8		 	
	SPGT090408-EM	0.8		 	
	SPGT110408-EM	0.8		 	
	SPGT140512-EM	1.2		 	

● Ex stock ○ On demand

HC¹ Coated carbide
HW Uncoated carbide

Tool holder			
ZTD02	ZTD03	ZTD04	ZTD05
			
C22	C24	C26	C28

System code > C32

Grade selection > C8

Technical info > C201

Cutting data > C36

WCMX	L	I.C	S	d
03 02	3.8	5.56	2.38	2.8
04 02	4.3	6.35	2.38	3.1
05 03	5.4	7.94	3.18	3.2
06 T3	6.5	9.525	3.97	3.7
08 04	8.7	12.7	4.76	4.3

- Ideal machining conditions
- Normal machining conditions
- Unfavourable machining conditions

Drilling inserts

WC** drilling insert			HC ¹ (CVD)		HC ¹ (PVD)					HW	
	P										
	M										
	K										
	N										
	S										
	H										
ISO		r	YB6338 YBD252		YBG105 YBG202 YBS203 YBG205 YB9320 YBG212					YD201	
	WCMX030208R-53	0.8	●		○						
	WCMX040208R-53	0.8	●		○						
	WCMX050308R-53	0.8	●		○						
	WCMX06T308R-53	0.8	●		○					○	
	WCMX080412R-53	1.2	●		○						
	WCMX06T308-D	0.8	○								
	WCMX080412-D	1.2	●								
	WCMX030208R-PG	0.8			○						
	WCMX040208R-PG	0.8			○						
	WCMX050308R-PG	0.8	○		○	○					
	WCMX06T308R-PG	0.8			○						
	WCMX080412R-PG	1.2			○						

● Ex stock ○ On demand

HC¹ Coated carbide
HW Uncoated carbide



Indexable drills

	Material group	Composition / structure / heat treatment		HB	Machining group	ZSD*		ZSD*			
						SPMX04		SPMX05/06			
						v _c [m/min]	f [mm]	v _c [m/min]	f [mm]		
A Turning	P Unalloyed steel	approx. 0,15 % C	annealed	125	1	200-300	0,05-0,08	200-300	0,05-0,10		
		approx. 0,45 % C	annealed	190	2	200-300	0,05-0,08	200-300	0,05-0,10		
		approx. 0,45 % C	tempered	250	3	200-300	0,05-0,08	200-300	0,05-0,10		
		approx. 0,75 % C	annealed	270	4	200-300	0,05-0,08	200-300	0,05-0,10		
		approx. 0,75 % C	tempered	300	5	200-300	0,05-0,08	200-300	0,05-0,10		
	P Low-alloyed steel			annealed	180	6	140-220	0,05-0,08	140-220	0,05-0,10	
				tempered	275	7	140-220	0,05-0,08	140-220	0,05-0,10	
				tempered	300	8	140-220	0,05-0,08	140-220	0,05-0,10	
				tempered	350	9	140-220	0,05-0,08	140-220	0,05-0,10	
		High-alloyed steel and high-alloyed tool steel		annealed	200	10	120-180	0,05-0,08	120-180	0,05-0,10	
	hardened and tempered		325	11	120-180	0,05-0,08	120-180	0,05-0,10			
M Milling	Stainless steel	ferritic/martensitic	annealed	200	12	110-230	0,05-0,08	110-230	0,05-0,10		
		martensitic	tempered	240	13	110-230	0,05-0,08	110-230	0,05-0,10		
		austenitic	quench hardened	180	14	110-230	0,05-0,08	110-230	0,05-0,10		
		austenitic-ferritic		230	15	110-230	0,05-0,08	110-230	0,05-0,10		
		K Cast iron	Grey cast iron	perlitic/ferritic		180	16	170-240	0,05-0,08	170-240	0,05-0,10
	perlitic (martensitic)		260	17	170-240	0,05-0,08	170-240	0,05-0,10			
Cast iron with spheroidal graphite	ferritic		160	18	130-200	0,05-0,08	130-200	0,05-0,10			
	perlitic		250	19	130-200	0,05-0,08	130-200	0,05-0,10			
Malleable cast iron	ferritic		130	20	120-220	0,05-0,08	120-220	0,05-0,10			
	perlitic		230	21	120-220	0,05-0,08	120-220	0,05-0,10			
C Drilling	Aluminium wrought alloys	cannot be hardened		60	22						
		hardenable	hardened	100	23						
	N Cast aluminium alloys	≤ 12 % Si, cannot be hardened		75	24						
		≤ 12 % Si, hardenable	hardened	90	25						
		> 12 % Si, cannot be hardened		130	26						
	Copper and copper alloys (bronze/brass)	machining steel, PB > 1%		110	27						
		CuZn, CuSnZn		90	28						
		CuSn, Pb-free copper, electrolytic copper		100	29						
	D Technical Information	S Heat-resistant alloys	Fe-based alloys	annealed	200	30					
				hardened	280	31					
Ni or Co base			annealed	250	32						
			hardened	350	33						
			cast	320	34						
Titanium alloys		pure titanium	R _m 400	35							
	α and β alloys	hardened	R _m 1050	36							
H Hardened steel			hardened and tempered	55 HRC	37						
			hardened and tempered	60 HRC	38						
	Hard cast iron		cast	400	39						
	Hardened cast iron		hardened and tempered	55 HRC	40						
E Index	X Non-metallic materials	Thermoplasts			41						
		Thermosetting plastics			42						
		Plastic, glass-fibre reinforced GFRP			43						
		Plastic, carbon fibre reinforced CFRP			44						
		Graphite			45						
		Wood			46						

Note: The given cutting values are guide values, which were determined under ideal conditions.
 The values have to be adapted in individual cases.
 With hole depths of 5xD adjust the cutting data accordingly to the application.
 For examples of material for cutting tool groups view page D11.

CARBIDE DRILLS

SOLID CARBIDE DRILLS



Solid carbide drills

Product overview	C40-C41
Grade overview	C42
System code – solide carbide drills	C44-C45
SU series	C47-C88
SL/SP series	C89-C108
UD series	C109-C116
GD series	C117-C126
SH series	C127-C128
SC series	C129-C132
PA series	C133-C136
PC series	C137-C140
NC-tapping device – SC series	C141-C143
Recommended cutting data	C144-C149
Trouble shooting	C202-C205
Technical information	C201-C207
Special tools	C150-C151



A

Turning

B

Milling

C

Drilling

D

Technical
Information

E





Index

Solid carbide drills Product overview

A Turning
B Milling
C Drilling
D Technical Information
E Index

	Products	Solid Carbide Drills	L/D	*	Ø	Application						Type	Page
						P	M	K	N	S	H		
SU	1534SU03		3xD		0.9-20	✓	✓	✓				Twist drills	C48
	1534SU03C		3xD	*	3-20	✓	✓	✓				Twist drills	C48
	1634SU03C		3xD	*	3-20	✓	✓	✓				Twist drills	C72
	1734SU03C		3xD	*	3-20	✓	✓	✓				Twist drills	C80
	1536SU05		5xD		2-20	✓	✓	✓				Twist drills	C59
	1536SU05C		5xD	*	3-20	✓	✓	✓				Twist drills	C59
	1636SU05C		5xD	*	3-20	✓	✓	✓				Twist drills	C76
	1736SU05C		5xD	*	3-20	✓	✓	✓				Twist drills	C84
	1538SU08C		8xD	*	3-18	✓	✓	✓				Twist drills	C69
	1557SU03		3xD		M4-M16	✓	✓	✓				Step drills	C88
SL SP	1588SL10C		10xD	*	3-14	✓	✓	✓	✓	✓		Deep hole drills	C89
	1588SL12C		12xD	*	3-21	✓	✓	✓	✓	✓		Deep hole drills	C92
	1588SL15C		15xD	*	3-14	✓	✓	✓	✓	✓		Deep hole drills	C96
	1588SL20C		20xD	*	3-14	✓	✓	✓	✓	✓		Deep hole drills	C99
	1588SL30C		30xD	*	3-10	✓	✓	✓	✓	✓		Deep hole drills	C102
	1534SP03C		3xD	*	3.03-20.03	✓	✓	✓	✓	✓		Pilot drills	C104
UD	1534UD03C		3xD	*	3-20	✓	✓			✓		Twist drills	C110
	1536UD05C		5xD	*	3-20	✓	✓			✓		Twist drills	C113
GD	1534GD03C		3xD	*	3-20	✓		✓				Twist drills	C118
	1536GD05C		5xD	*	3-20	✓		✓				Twist drills	C121
	1636GD05C		5xD	*	5-20	✓		✓				Twist drills	C124
SH	1534SH03		3xD		3-16						✓	Twist drills	C127
SC	1105SC03		3xD		2-16				✓			Twist drills	C129
	1101SC05		5xD		2-16				✓			Twist drills	C132
PA	1165PA03		3xD		3-20				✓			Three-lips drills	C133
PC	1576PC05		5xD		4-20			✓				Straight flute drills	C137
	1576PC05C		5xD	*	4-20			✓				Straight flute drills	C137

✓ Very suitable ✓ Suitable
* With internal cooling SC*: Centuring drills

	Products	Solid Carbide Drills	L/D	*	Ø	Application						Type	Page
						P	M	K	N	S	H		
PC	1579PC15C		15xD	*	5-14			✓				Straight flute drills	C139
SC*	1143SC90		-		5-20	✓	✓	✓	✓			Centuring drills	C141
	1143SC120		-	*	5-20	✓	✓	✓	✓			Centuring drills	C142
	1143SC142			*	5-20	✓	✓	✓	✓			Centuring drills	C143

✓ Very suitable ✓ Suitable

* With internal cooling SC*: Centuring drills

A

Turning

B

Milling

C

Drilling

D

Technical
Information

E

Index

A

Coated cemented carbide PVD

Grade	Grade description
-------	-------------------

Turning

KDG303 PVD coated P10–P20/M10–M20/K10–K20 carbide grade for steel, stainless steel and cast iron. Good wear resistance and toughness for a wide application field.

B

KDG304 PVD coated carbide substrate for machining caststeel and cast iron. Optimised toughness for high feeds.

Milling

KDG305 PVD coated carbide substrate for machining stainless steel and HRSA. High process reliability due to improved wear resistance.

C

Uncoated cemented carbide

Grade	Grade description
-------	-------------------

Drilling

YK20F Uncoated K20 carbide substrate for steel, cast iron and non ferrous materials.

D

YK30F Uncoated K30 carbide substrate for steel, stainless steel, cast iron and non ferrous materials.

Technical Information

E

Index

1 5 3 6 SU 05 (C) – 0850 (S)

1

2

3

4

5

6

7

8

9

A

Turning

Type	
Code	Description
1	Forets

1

Shank type	
Code	Description
1	Straight shank
2	Square shank DIN 10
3	Double flattened straight shank DIN 1809
5	Straight shank DIN 6535 HA
6	Weldon shank DIN 6535 HB
7	Whistle Notch shank DIN 6535 HE
9	Morse taper shank

2

B

Milling

Drill type	
Code	Description
0	Twist drill
3	Universal twist drill
4	NC tapping device
5	Step drill
6	Three-lips drill
7	Straight flute drill
8	Deep hole drill

3

Tool length	
Code	Description
1	DIN 338
2	DIN 1897
3	QJ/ZZQ(TO)01.001.002
4	DIN 6537 K
5	DIN 6539
6	DIN 6537 L
7	Factory standard ZCC-C
8	Factory standard ZCC-D
9	Factory standard ZCC-E

4

C

Drilling

Application	
Code	Description
UD	Twist drills for tough materials
GD	Twist drills for high feeds
SU	Twist drill for general machining
SUK	Twist drill for cast iron
SL	Twist drill for deep hole drilling
SLK	Deep hole drill for cast iron
SP	Pilot drill
SH	Twist drill for hardened materials
SC	Twist drill for non-ferrous metals and cast iron
PA	Three-lips drill for non-ferrous metals and cast iron
PC	Straight flute drill for non-ferrous metals and cast iron

5

E

Index

L/D relation		Angle	
Drill		NC tapping device	
Code	Description	Code	Description
03	3xD	90	90°
05	5xD	120	120°
08	8xD		
10	10xD		
12	12xD		
15	15xD		
20	20xD		
30	30xD		

With inner cooling

6

7

Bore diameter [mm]	
Code	Description
0200	2,0
0850	8,5
1800	18,0
...	

Shank diameter [mm]	
Code	Description
S	4,0

8

9

A
Turning

B
Milling

C
Drilling

D
Technical Information

E
Index



a Boring b Drilling c Profile drilling d Centering

IMPORTANT INFORMATION

Recommended applications for the **SU series**

Feed calculator

ISO group	Material	Cutting speed v_c (m/min)	Feed factor F_m
P	Low-alloy steel	180	0,015
	High-alloy steel	120	0,012
M	Stainless steels	80	0,01
K	Cast iron	250	0,018
	Cast steel	180	0,015
S	H RSA	45	0,008
N	Aluminium	400	0,02

Formula: feed per revolution (F_n) $D \times F_m$
Example: drill diameter (D) 10 mm
material high-alloy steel

$$F_n = 10 \text{ mm} \times 0,012 = 0,12 \text{ mm/rev.}$$



Fig.: 1536SU05C

SU(K) drill 3xD **General machining** Add K (SUK) to the code for use on Cast Iron

1534SU03/1534SU03C



- Type of shank DIN 6535HA
- Coolant exit, axial concentric



External coolant



Internal coolant

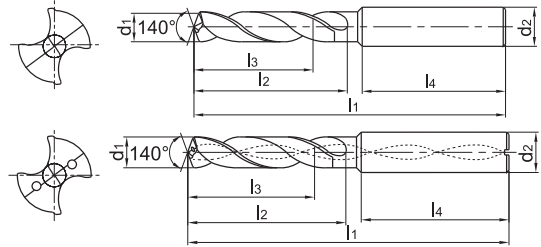

Article	*	Dimensions [mm]						Grade
		d ₁ (m7)	d ₂ (h6)	l ₁	l ₂	l ₃	l ₄	KDG303
1534SU03-0090S		0.9	4	47	4.2	3.4	37.9	○
1534SU03-0100S		1	4	47	4.7	3.8	37.6	●
1534SU03-0105S		1.05	4	47	4.9	3.9	37.5	●
1534SU03-0110S		1.1	4	47	5.2	4.1	37.2	○
1534SU03-0115S		1.15	4	47	5.4	4.3	37.1	○
1534SU03-0120S		1.2	4	47	5.6	4.5	37	●
1534SU03-0125S		1.25	4	47	5.9	4.7	36.8	○
1534SU03-0130S		1.3	4	47	6.1	4.9	36.6	●
1534SU03-0135S		1.35	4	47	6.3	5.1	36.5	○
1534SU03-0140S		1.4	4	47	6.6	5.3	36.3	○
1534SU03-0145S		1.45	4	47	6.8	5.4	36.2	○
1534SU03-0147S		1.47	4	47	6.9	5.5	36.1	●
1534SU03-0150S		1.5	4	47	7.1	5.6	36	●
1534SU03-0155S		1.55	4	47	7.3	5.8	35.8	○
1534SU03-0160S		1.6	4	47	7.5	6	35.7	●
1534SU03-0165S		1.65	4	47	7.8	6.2	35.5	○
1534SU03-0170S		1.7	4	47	8	6.4	35.4	●
1534SU03-0175S		1.75	4	47	8.2	6.6	35.2	○
1534SU03-0180S		1.8	4	47	8.5	6.8	35	●
1534SU03-0185S		1.85	4	47	8.7	6.9	34.9	○
1534SU03-0190S		1.9	4	47	8.9	7.1	34.8	●
1534SU03-0195S		1.95	4	47	9.2	7.3	34.5	○
1534SU03-0200		2	6	62	20	14	36	●
1534SU03-0210		2.1	6	62	20	14	36	●
1534SU03-0220		2.2	6	62	20	14	36	●
1534SU03-0230		2.33	3	59	13.8	14	36	●
1534SU03-0240		2.4	6	62	20	14	36	●
1534SU03-0250		2.5	6	62	20	14	36	●
1534SU03-0260		2.6	6	62	20	14	36	●
1534SU03-0270		2.7	6	62	20	14	36	●
1534SU03-0280		2.8	6	62	20	14	36	●

- Ex stock ○ On demand
- All articles SUK on demand
- * With internal cooling

Application field

Type	P	M	K	N	S	H
1534SU*	✓	✓	✓			
1534SUK*			✓			

- ✓ Very suitable
- ✓ Suitable

System code > C44

Machining instructions > C201

Cutting data > C144

Nonstandard order > C150

SU(K) drill 3xD

General machining

Add K (SUK) to the code for use on Cast Iron

1534SU03/1534SU03C



- Type of shank DIN 6535HA
- Coolant exit, axial concentric



External coolant



Internal coolant

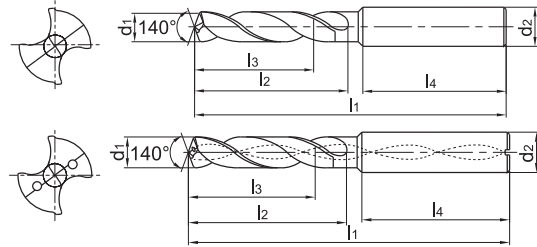

Article	*	Dimensions [mm]						Grade
		d ₁ (m7)	d ₂ (h6)	l ₁	l ₂	l ₃	l ₄	KDG303
1534SU03-0290		2.9	6	62	20	14	36	●
1534SU03-0300		3	6	62	20	14	36	●
1534SU03C-0300	*	3	6	62	20	14	36	●
1534SU03-0310		3.1	6	62	20	14	36	●
1534SU03C-0310	*	3.1	6	62	20	14	36	●
1534SU03-0320		3.2	6	62	20	14	36	●
1534SU03C-0320	*	3.2	6	62	20	14	36	●
1534SU03-0325		3.25	6	62	20	14	36	●
1534SU03C-0325	*	3.25	6	62	20	14	36	●
1534SU03-0330		3.3	6	62	20	14	36	●
1534SU03C-0330	*	3.3	6	62	20	14	36	●
1534SU03-0340		3.4	6	62	20	14	36	●
1534SU03C-0340	*	3.4	6	62	20	14	36	●
1534SU03-0350		3.5	6	62	20	14	36	●
1534SU03C-0350	*	3.5	6	62	20	14	36	●
1534SU03-0360		3.6	6	62	20	14	36	●
1534SU03C-0360	*	3.6	6	62	20	14	36	●
1534SU03-0370		3.7	6	62	20	14	36	●
1534SU03C-0370	*	3.7	6	62	20	14	36	●
1534SU03-0380		3.8	6	66	24	17	36	●
1534SU03C-0380	*	3.8	6	66	24	17	36	●
1534SU03-0390		3.9	6	66	24	17	36	●
1534SU03C-0390	*	3.9	6	66	24	17	36	●
1534SU03-0400		4	6	66	24	17	36	●
1534SU03C-0400	*	4	6	66	24	17	36	●
1534SU03-0410		4.1	6	66	24	17	36	●
1534SU03C-0410	*	4.1	6	66	24	17	36	●
1534SU03-0420		4.2	6	66	24	17	36	●
1534SU03C-0420	*	4.2	6	66	24	17	36	●
1534SU03-0430		4.3	6	66	24	17	36	●
1534SU03C-0430	*	4.3	6	66	24	17	36	●

● Ex stock ○ On demand

All articles SUK on demand

* With internal cooling

Application field						
Type	P	M	K	N	S	H
1534SU*	✓	✓	✓			
1534SUK*			✓			

✓ Very suitable

✓ Suitable

System code > C44

Machining instructions > C201

Cutting data > C144

Nonstandard order > C150



A

Turning

B

Milling

C

Drilling

D

Technical Information

E

Index

SU(K) drill 3xD **General machining** Add K (SUK) to the code for use on Cast Iron

1534SU03/1534SU03C



- Type of shank DIN 6535HA
- Coolant exit, axial concentric

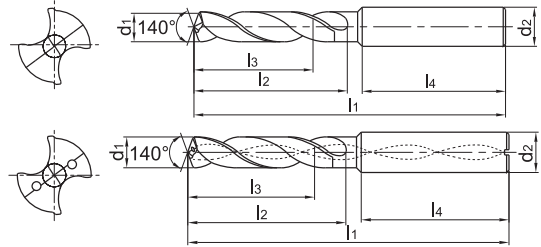
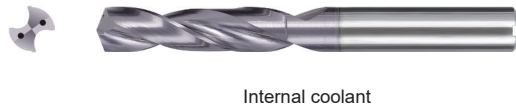

Article	*	Dimensions [mm]						Grade
		d ₁ (m7)	d ₂ (h6)	l ₁	l ₂	l ₃	l ₄	KDG303
1534SU03-0440		4.4	6	66	24	17	36	●
1534SU03C-0440	*	4.4	6	66	24	17	36	●
1534SU03-0450		4.5	6	66	24	17	36	●
1534SU03C-0450	*	4.5	6	66	24	17	36	●
1534SU03-0460		4.6	6	66	24	17	36	●
1534SU03C-0460	*	4.6	6	66	24	17	36	●
1534SU03-0465		4.65	6	66	24	17	36	●
1534SU03C-0465	*	4.65	6	66	24	17	36	●
1534SU03-0470		4.7	6	66	24	17	36	●
1534SU03C-0470	*	4.7	6	66	24	17	36	●
1534SU03-0480		4.8	6	66	28	20	36	●
1534SU03C-0480	*	4.8	6	66	28	20	36	●
1534SU03-0490		4.9	6	66	28	20	36	●
1534SU03C-0490	*	4.9	6	66	28	20	36	●
1534SU03-0500		5	6	66	28	20	36	●
1534SU03C-0500	*	5	6	66	28	20	36	●
1534SU03-0510		5.1	6	66	28	20	36	●
1534SU03C-0510	*	5.1	6	66	28	20	36	●
1534SU03-0520		5.2	6	66	28	20	36	●
1534SU03C-0520	*	5.2	6	66	28	20	36	●
1534SU03-0530		5.3	6	66	28	20	36	●
1534SU03C-0530	*	5.3	6	66	28	20	36	●
1534SU03-0540		5.4	6	66	28	20	36	●
1534SU03C-0540	*	5.4	6	66	28	20	36	●
1534SU03-0550		5.5	6	66	28	20	36	●
1534SU03C-0550	*	5.5	6	66	28	20	36	●
1534SU03-0555		5.55	6	66	28	20	36	●
1534SU03C-0555	*	5.55	6	66	28	20	36	●
1534SU03-0560		5.6	6	66	28	20	36	●
1534SU03C-0560	*	5.6	6	66	28	20	36	●
1534SU03-0570		5.7	6	66	28	20	36	●

- Ex stock ○ On demand
- All articles SUK on demand
- * With internal cooling

Application field

Type	P	M	K	N	S	H
1534SU*	✓	✓	✓			
1534SUK*			✓			

- ✓ Very suitable
- ✓ Suitable

System code > C44

Machining instructions > C201

Cutting data > C144

Nonstandard order > C150

SU(K) drill 3xD

General machining

Add K (SUK) to the code for use on Cast Iron

1534SU03/1534SU03C



- Type of shank DIN 6535HA
- Coolant exit, axial concentric



External coolant



Internal coolant

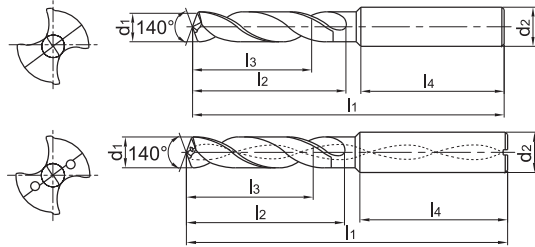

Article	*	Dimensions [mm]						Grade
		d ₁ (m7)	d ₂ (h6)	l ₁	l ₂	l ₃	l ₄	KDG303
1534SU03C-0570	*	5.7	6	66	28	20	36	●
1534SU03-0580		5.8	6	66	28	20	36	●
1534SU03C-0580	*	5.8	6	66	28	20	36	●
1534SU03-0590		5.9	6	66	28	20	36	●
1534SU03C-0590	*	5.9	6	66	28	20	36	●
1534SU03-0600		6	6	66	28	20	36	●
1534SU03C-0600	*	6	6	66	28	20	36	●
1534SU03-0610		6.1	8	79	34	24	36	●
1534SU03C-0610	*	6.1	8	79	34	24	36	●
1534SU03-0620		6.2	8	79	34	24	36	●
1534SU03C-0620	*	6.2	8	79	34	24	36	●
1534SU03-0630		6.3	8	79	34	24	36	●
1534SU03C-0630	*	6.3	8	79	34	24	36	●
1534SU03-0640		6.4	8	79	34	24	36	●
1534SU03C-0640	*	6.4	8	79	34	24	36	●
1534SU03-0650		6.5	8	79	34	24	36	●
1534SU03C-0650	*	6.5	8	79	34	24	36	●
1534SU03-0660		6.6	8	79	34	24	36	●
1534SU03C-0660	*	6.6	8	79	34	24	36	●
1534SU03-0670		6.7	8	79	34	24	36	●
1534SU03C-0670	*	6.7	8	79	34	24	36	●
1534SU03-0675		6.75	8	79	34	24	36	●
1534SU03C-0675	*	6.75	8	79	34	24	36	●
1534SU03-0680		6.8	8	79	34	24	36	●
1534SU03C-0680	*	6.8	8	79	34	24	36	●
1534SU03-0690		6.9	8	79	34	24	36	●
1534SU03C-0690	*	6.9	8	79	34	24	36	●
1534SU03-0700		7	8	79	34	24	36	●
1534SU03C-0700	*	7	8	79	34	24	36	●
1534SU03-0710		7.1	8	79	41	29	36	●
1534SU03C-0710	*	7.1	8	79	41	29	36	●

● Ex stock ○ On demand

All articles SUK on demand

* With internal cooling

Application field

Type	P	M	K	N	S	H
1534SU*	✓	✓	✓			
1534SUK*			✓			

✓ Very suitable

✓ Suitable

System code > C44

Machining instructions > C201

Cutting data > C144

Nonstandard order > C150



SU(K) drill 3xD **General machining** Add K (SUK) to the code for use on Cast Iron

1534SU03/1534SU03C



- Type of shank DIN 6535HA
- Coolant exit, axial concentric

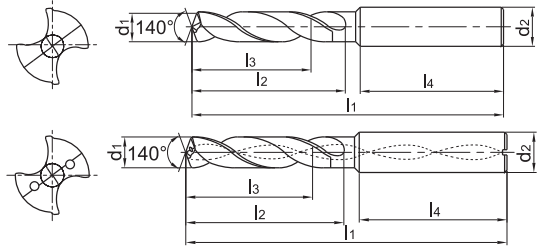
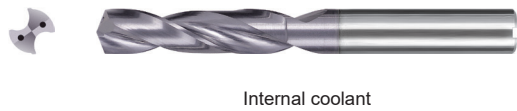

Article	*	Dimensions [mm]						Grade
		d ₁ (m7)	d ₂ (h6)	l ₁	l ₂	l ₃	l ₄	KDG303
1534SU03-0720		7.2	8	79	41	29	36	●
1534SU03C-0720	*	7.2	8	79	41	29	36	●
1534SU03-0730		7.3	8	79	41	29	36	●
1534SU03C-0730	*	7.3	8	79	41	29	36	●
1534SU03-0740		7.4	8	79	41	29	36	●
1534SU03C-0740	*	7.4	8	79	41	29	36	●
1534SU03-0745		7.45	8	79	41	29	36	○
1534SU03C-0745	*	7.45	8	79	41	29	36	○
1534SU03-0750		7.5	8	79	41	29	36	●
1534SU03C-0750	*	7.5	8	79	41	29	36	●
1534SU03-0760		7.6	8	79	41	29	36	●
1534SU03C-0760	*	7.6	8	79	41	29	36	●
1534SU03-0770		7.7	8	79	41	29	36	●
1534SU03C-0770	*	7.7	8	79	41	29	36	●
1534SU03-0780		7.8	8	79	41	29	36	●
1534SU03C-0780	*	7.8	8	79	41	29	36	●
1534SU03-0790		7.9	8	79	41	29	36	●
1534SU03C-0790	*	7.9	8	79	41	29	36	●
1534SU03-0800		8	8	79	41	29	36	●
1534SU03C-0800	*	8	8	79	41	29	36	●
1534SU03-0810		8.1	10	89	47	35	40	●
1534SU03C-0810	*	8.1	10	89	47	35	40	●
1534SU03-0820		8.2	10	89	47	35	40	●
1534SU03C-0820	*	8.2	10	89	47	35	40	●
1534SU03-0830		8.3	10	89	47	35	40	●
1534SU03C-0830	*	8.3	10	89	47	35	40	●
1534SU03-0840		8.4	10	89	47	35	40	●
1534SU03C-0840	*	8.4	10	89	47	35	40	●
1534SU03-0850		8.5	10	89	47	35	40	●
1534SU03C-0850	*	8.5	10	89	47	35	40	●
1534SU03-0860		8.6	10	89	47	35	40	●

- Ex stock ○ On demand
- All articles SUK on demand
- * With internal cooling

Application field

Type	P	M	K	N	S	H
1534SU*	✓	✓	✓			
1534SUK*			✓			

- ✓ Very suitable
- ✓ Suitable

System code > C44

Machining instructions > C201

Cutting data > C144

Nonstandard order > C150

SU(K) drill 3xD

General machining

Add K (SUK) to the code for use on Cast Iron

1534SU03/1534SU03C



- Type of shank DIN 6535HA
- Coolant exit, axial concentric



External coolant



Internal coolant

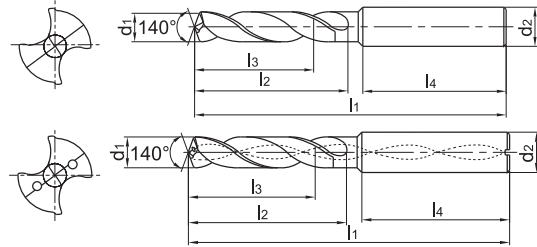

Article	*	Dimensions [mm]						Grade
		d ₁ (m7)	d ₂ (h6)	l ₁	l ₂	l ₃	l ₄	KDG303
1534SU03C-0860	*	8.6	10	89	47	35	40	●
1534SU03-0870		8.7	10	89	47	35	40	●
1534SU03C-0870	*	8.7	10	89	47	35	40	●
1534SU03-0880		8.8	10	89	47	35	40	●
1534SU03C-0880	*	8.8	10	89	47	35	40	●
1534SU03-0890		8.9	10	89	47	35	40	●
1534SU03C-0890	*	8.9	10	89	47	35	40	●
1534SU03-0900		9	10	89	47	35	40	●
1534SU03C-0900	*	9	10	89	47	35	40	●
1534SU03-0910		9.1	10	89	47	35	40	●
1534SU03C-0910	*	9.1	10	89	47	35	40	●
1534SU03-0920		9.2	10	89	47	35	40	●
1534SU03C-0920	*	9.2	10	89	47	35	40	●
1534SU03-0930		9.3	10	89	47	35	40	●
1534SU03C-0930	*	9.3	10	89	47	35	40	●
1534SU03-0935		9.35	10	89	47	35	40	○
1534SU03C-0935	*	9.35	10	89	47	35	40	○
1534SU03-0940		9.4	10	89	47	35	40	●
1534SU03C-0940	*	9.4	10	89	47	35	40	●
1534SU03-0945		9.45	10	89	47	35	40	○
1534SU03C-0945	*	9.45	10	89	47	35	40	○
1534SU03-0950		9.5	10	89	47	35	40	●
1534SU03C-0950	*	9.5	10	89	47	35	40	●
1534SU03-0960		9.6	10	89	47	35	40	●
1534SU03C-0960	*	9.6	10	89	47	35	40	●
1534SU03-0970		9.7	10	89	47	35	40	●
1534SU03C-0970	*	9.7	10	89	47	35	40	●
1534SU03-0980		9.8	10	89	47	35	40	●
1534SU03C-0980	*	9.8	10	89	47	35	40	●
1534SU03-0990		9.9	10	89	47	35	40	●
1534SU03C-0990	*	9.9	10	89	47	35	40	●

● Ex stock ○ On demand

All articles SUK on demand

* With internal cooling

Application field						
Type	P	M	K	N	S	H
1534SU*	✓	✓	✓			
1534SUK*			✓			

✓ Very suitable

✓ Suitable

System code > C44

Machining instructions > C201

Cutting data > C144

Nonstandard order > C150



A

Turning

B

Milling

C

Drilling

D

Technical Information

E

Index

SU(K) drill 3xD **General machining** Add K (SUK) to the code for use on Cast Iron

1534SU03/1534SU03C



- Type of shank DIN 6535HA
- Coolant exit, axial concentric

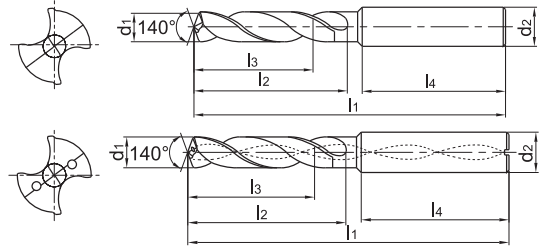
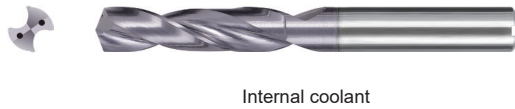

Article	*	Dimensions [mm]						Grade
		d ₁ (m7)	d ₂ (h6)	l ₁	l ₂	l ₃	l ₄	KDG303
1534SU03-1000		10	10	89	47	35	40	●
1534SU03C-1000	*	10	10	89	47	35	40	●
1534SU03-1010		10.1	12	102	55	40	45	●
1534SU03C-1010	*	10.1	12	102	55	40	45	●
1534SU03-1020		10.2	12	102	55	40	45	●
1534SU03C-1020	*	10.2	12	102	55	40	45	●
1534SU03-1025		10.25	12	102	55	40	45	●
1534SU03C-1025	*	10.25	12	102	55	40	45	●
1534SU03-1030		10.3	12	102	55	40	45	●
1534SU03C-1030	*	10.3	12	102	55	40	45	●
1534SU03-1040		10.4	12	102	55	40	45	●
1534SU03C-1040	*	10.4	12	102	55	40	45	●
1534SU03-1050		10.5	12	102	55	40	45	●
1534SU03C-1050	*	10.5	12	102	55	40	45	●
1534SU03-1060		10.6	12	102	55	40	45	●
1534SU03C-1060	*	10.6	12	102	55	40	45	●
1534SU03-1070		10.7	12	102	55	40	45	●
1534SU03C-1070	*	10.7	12	102	55	40	45	●
1534SU03-1080		10.8	12	102	55	40	45	●
1534SU03C-1080	*	10.8	12	102	55	40	45	●
1534SU03-1090		10.9	12	102	55	40	45	●
1534SU03C-1090	*	10.9	12	102	55	40	45	●
1534SU03-1100		11	12	102	55	40	45	●
1534SU03C-1100	*	11	12	102	55	40	45	●
1534SU03-1110		11.1	12	102	55	40	45	●
1534SU03C-1110	*	11.1	12	102	55	40	45	●
1534SU03-1120		11.2	12	102	55	40	45	●
1534SU03C-1120	*	11.2	12	102	55	40	45	●
1534SU03-1125		11.25	12	102	55	40	45	○
1534SU03C-1125	*	11.25	12	102	55	40	45	○
1534SU03-1130		11.3	12	102	55	40	45	●

- Ex stock ○ On demand
- All articles SUK on demand
- * With internal cooling

Application field

Type	P	M	K	N	S	H
1534SU*	✓	✓	✓			
1534SUK*			✓			

- ✓ Very suitable
- ✓ Suitable

System code > C44

Machining instructions > C201

Cutting data > C144

Nonstandard order > C150

SU(K) drill 3xD

General machining

Add K (SUK) to the code for use on Cast Iron

1534SU03/1534SU03C



- Type of shank DIN 6535HA
- Coolant exit, axial concentric



External coolant



Internal coolant

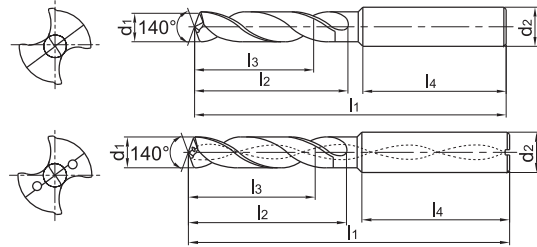

Article	*	Dimensions [mm]						Grade
		d ₁ (m7)	d ₂ (h6)	l ₁	l ₂	l ₃	l ₄	KDG303
1534SU03C-1130	*	11.3	12	102	55	40	45	●
1534SU03-1135		11.35	12	102	55	40	45	○
1534SU03C-1135	*	11.35	12	102	55	40	45	○
1534SU03-1140		11.4	12	102	55	40	45	●
1534SU03C-1140	*	11.4	12	102	55	40	45	●
1534SU03-1145		11.45	12	102	55	40	45	○
1534SU03C-1145	*	11.45	12	102	55	40	45	○
1534SU03-1150		11.5	12	102	55	40	45	●
1534SU03C-1150	*	11.5	12	102	55	40	45	●
1534SU03-1160		11.6	12	102	55	40	45	●
1534SU03C-1160	*	11.6	12	102	55	40	45	●
1534SU03-1170		11.7	12	102	55	40	45	●
1534SU03C-1170	*	11.7	12	102	55	40	45	●
1534SU03-1180		11.8	12	102	55	40	45	●
1534SU03C-1180	*	11.8	12	102	55	40	45	●
1534SU03-1190		11.9	12	102	55	40	45	●
1534SU03C-1190	*	11.9	12	102	55	40	45	●
1534SU03-1200		12	12	102	55	40	45	●
1534SU03C-1200	*	12	12	102	55	40	45	●
1534SU03-1210		12.1	14	107	60	43	45	●
1534SU03C-1210	*	12.1	14	107	60	43	45	●
1534SU03-1220		12.2	14	107	60	43	45	●
1534SU03C-1220	*	12.2	14	107	60	43	45	●
1534SU03-1225		12.25	14	107	60	43	45	●
1534SU03C-1225	*	12.25	14	107	60	43	45	●
1534SU03-1230		12.3	14	107	60	43	45	●
1534SU03C-1230	*	12.3	14	107	60	43	45	●
1534SU03-1250		12.5	14	107	60	43	45	●
1534SU03C-1250	*	12.5	14	107	60	43	45	●
1534SU03-1270		12.7	14	107	60	43	45	●
1534SU03C-1270	*	12.7	14	107	60	43	45	●

● Ex stock ○ On demand

All articles SUK on demand

* With internal cooling

Application field						
Type	P	M	K	N	S	H
1534SU*	✓	✓	✓			
1534SUK*			✓			

✓ Very suitable

✓ Suitable

System code > C44

Machining instructions > C201

Cutting data > C144

Nonstandard order > C150



A

Turning

B

Milling

C

Drilling

D

Technical Information

E

Index

SU(K) drill 3xD **General machining** Add K (SUK) to the code for use on Cast Iron

1534SU03/1534SU03C



- Type of shank DIN 6535HA
- Coolant exit, axial concentric

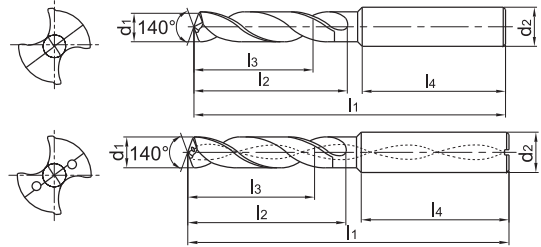
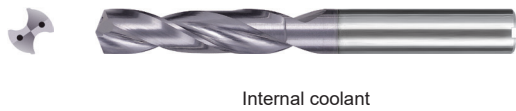
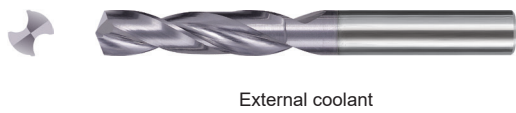

Article	*	Dimensions [mm]						Grade
		d ₁ (m7)	d ₂ (h6)	l ₁	l ₂	l ₃	l ₄	KDG303
1534SU03-1275		12.75	14	107	60	43	45	●
1534SU03C-1275	*	12.75	14	107	60	43	45	●
1534SU03-1280		12.8	14	107	60	43	45	●
1534SU03C-1280	*	12.8	14	107	60	43	45	●
1534SU03-1300		13	14	107	60	43	45	●
1534SU03C-1300	*	13	14	107	60	43	45	●
1534SU03-1310		13.1	14	107	60	43	45	●
1534SU03C-1310	*	13.1	14	107	60	43	45	●
1534SU03-1335	*	13.35	14	107	60	43	45	●
1534SU03-1350		13.5	14	107	60	43	45	●
1534SU03C-1350	*	13.5	14	107	60	43	45	●
1534SU03-1380		13.8	14	107	60	43	45	●
1534SU03C-1380	*	13.8	14	107	60	43	45	●
1534SU03-1400		14	14	107	60	43	45	●
1534SU03C-1400	*	14	14	107	60	43	45	●
1534SU03-1420		14.2	16	107	60	43	45	●
1534SU03C-1420	*	14.2	16	107	60	43	45	●
1534SU03-1425		14.25	16	115	65	45	48	●
1534SU03C-1425	*	14.25	16	115	65	45	48	●
1534SU03-1430		14.3	16	115	65	45	48	●
1534SU03C-1430	*	14.3	16	115	65	45	48	●
1534SU03-1450		14.5	16	115	65	45	48	●
1534SU03C-1450	*	14.5	16	115	65	45	48	●
1534SU03-1475		14.75	16	115	65	45	48	●
1534SU03C-1475	*	14.75	16	115	65	45	48	●
1534SU03-1480		14.8	16	115	65	45	48	●
1534SU03C-1480	*	14.8	16	115	65	45	48	●
1534SU03-1500		15	16	115	65	45	48	●
1534SU03C-1500	*	15	16	115	65	45	48	●
1534SU03-1510		15.1	16	115	65	45	48	●
1534SU03C-1510	*	15.1	16	115	65	45	48	●

- Ex stock ○ On demand
- All articles SUK on demand
- * With internal cooling

Application field

Type	P	M	K	N	S	H
1534SU*	✓	✓	✓			
1534SUK*			✓			

- ✓ Very suitable
- ✓ Suitable

System code > C44

Machining instructions > C201

Cutting data > C144

Nonstandard order > C150

SU(K) drill 3xD

General machining

Add K (SUK) to the code for use on Cast Iron

1534SU03/1534SU03C



- Type of shank DIN 6535HA
- Coolant exit, axial concentric



External coolant



Internal coolant

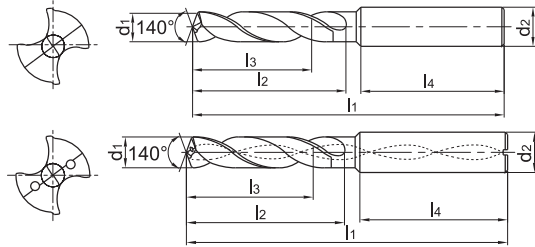

Article	*	Dimensions [mm]						Grade
		d ₁ (m7)	d ₂ (h6)	l ₁	l ₂	l ₃	l ₄	KDG303
1534SU03-1530		15.3	16	115	65	45	48	●
1534SU03C-1535	*	15.35	16	115	65	45	48	○
1534SU03-1550		15.5	16	115	65	45	48	●
1534SU03C-1550	*	15.5	16	115	65	45	48	●
1534SU03-1580		15.8	16	115	65	45	48	●
1534SU03C-1580	*	15.8	16	115	65	45	48	●
1534SU03-1600		16	16	115	65	45	48	●
1534SU03C-1600	*	16	16	115	65	45	48	●
1534SU03-1610		16.1	18	123	73	51	48	●
1534SU03-1650		16.5	18	123	73	51	48	●
1534SU03C-1650	*	16.5	18	123	73	51	48	●
1534SU03-1675		16.75	18	123	73	51	48	●
1534SU03C-1675	*	16.75	18	123	73	51	48	●
1534SU03-1680		16.8	18	123	73	51	48	●
1534SU03C-1680	*	16.8	18	123	73	51	48	●
1534SU03-1700		17	18	123	73	51	48	●
1534SU03C-1700	*	17	18	123	73	51	48	●
1534SU03-1750		17.5	18	123	73	51	48	●
1534SU03C-1750	*	17.5	18	123	73	51	48	●
1534SU03-1780		17.8	18	123	73	51	48	●
1534SU03C-1780	*	17.8	18	123	73	51	48	●
1534SU03-1800		18	18	123	73	51	48	●
1534SU03C-1800	*	18	18	123	73	51	48	●
1534SU03-1850		18.5	20	131	79	55	50	●
1534SU03C-1850	*	18.5	20	131	79	55	50	●
1534SU03-1880		18.8	20	131	79	55	50	●
1534SU03C-1880	*	18.8	20	131	79	55	50	●
1534SU03-1900		19	20	131	79	55	50	●
1534SU03C-1900	*	19	20	131	79	55	50	●
1534SU03-1950		19.5	20	131	79	55	50	●
1534SU03C-1950	*	19.5	20	131	79	55	50	●

● Ex stock ○ On demand

All articles SUK on demand

* With internal cooling

Application field						
Type	P	M	K	N	S	H
1534SU*	✓	✓	✓			
1534SUK*			✓			

✓ Very suitable

✓ Suitable

System code > C44

Machining instructions > C201

Cutting data > C144

Nonstandard order > C150



A

Turning

B

Milling

C

Drilling

D

Technical Information

E

Index

A

SU(K) drill 3xD **General machining** Add K (SUK) to the code for use on Cast Iron

Turning

1534SU03/1534SU03C



- Type of shank DIN 6535HA
- Coolant exit, axial concentric



External coolant



Internal coolant

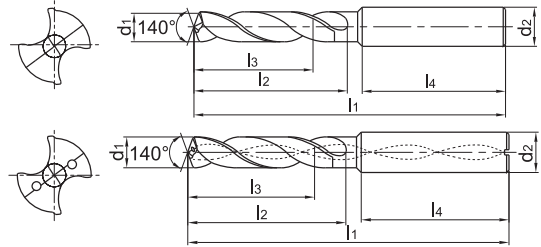

B

Milling

Article	*	Dimensions [mm]						Grade
		d ₁ (m7)	d ₂ (h6)	l ₁	l ₂	l ₃	l ₄	KDG303
1534SU03-1980		19.8	20	131	79	55	50	●
1534SU03C-1980	*	19.8	20	131	79	55	50	●
1534SU03-2000		20	20	131	79	55	50	●
1534SU03C-2000	*	20	20	131	79	55	50	●

● Ex stock ○ On demand

All articles SUK on demand

* With internal cooling

C

Drilling

Application field

Type	P	M	K	N	S	H
1534SU*	✓	✓	✓			
1534SUK*			✓			

- ✓ Very suitable
- ✓ Suitable

D

Technical Information

E

Index

System code > C44

Machining instructions > C201

Cutting data > C144

Nonstandard order > C150

SU(K) drill 5xD

General machining

Add K (SUK) to the code for use on Cast Iron

1536SU05/1536SU05C



- Type of shank DIN 6535HA
- Coolant exit, axial concentric



External coolant



Internal coolant

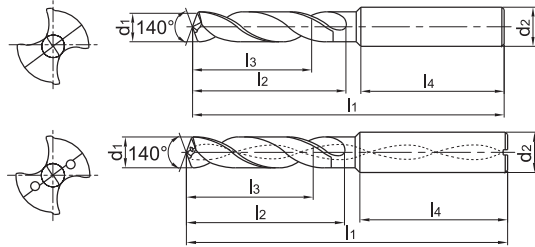

Article	*	Dimensions [mm]						Grade
		d ₁ (m7)	d ₂ (h6)	l ₁	l ₂	l ₃	l ₄	KDG303
1536SU05-0200		2	6	66	28	23	36	●
1536SU05-0210		2.1	6	66	28	23	36	●
1536SU05-0220		2.2	6	66	28	23	36	●
1536SU05-0230		2.3	6	66	28	23	36	●
1536SU05-0240		2.4	6	66	28	23	36	●
1536SU05-0250		2.5	6	66	28	23	36	●
1536SU05-0260		2.6	6	66	28	23	36	●
1536SU05-0270		2.7	6	66	28	23	36	●
1536SU05-0280		2.8	6	66	28	23	36	●
1536SU05-0290		2.9	6	66	28	23	36	●
1536SU05-0300		3	6	66	28	23	36	●
1536SU05C-0300	*	3	6	66	28	23	36	●
1536SU05-0310		3.1	6	66	28	23	36	●
1536SU05C-0310	*	3.1	6	66	28	23	36	●
1536SU05-0320		3.2	6	66	28	23	36	●
1536SU05C-0320	*	3.2	6	66	28	23	36	●
1536SU05-0325		3.25	6	66	28	23	36	●
1536SU05C-0325	*	3.25	6	66	28	23	36	●
1536SU05-0330		3.3	6	66	28	23	36	●
1536SU05C-0330	*	3.3	6	66	28	23	36	●
1536SU05-0340		3.4	6	66	28	23	36	●
1536SU05C-0340	*	3.4	6	66	28	23	36	●
1536SU05-0350		3.5	6	66	28	23	36	●
1536SU05C-0350	*	3.5	6	66	28	23	36	●
1536SU05-0360		3.6	6	66	28	23	36	●
1536SU05C-0360	*	3.6	6	66	28	23	36	●
1536SU05-0370		3.7	6	66	28	23	36	●
1536SU05C-0370	*	3.7	6	66	28	23	36	●
1536SU05-0380		3.8	6	74	36	29	36	●
1536SU05C-0380	*	3.8	6	74	36	29	36	●
1536SU05-0390		3.9	6	74	36	29	36	●

- Ex stock ○ On demand
- All articles SUK on demand
- * With internal cooling

Application field						
Type	P	M	K	N	S	H
1536SU*	✓	✓	✓			
1536SUK*			✓			

- ✓ Very suitable
- ✓ Suitable



A
Turning
B
Milling
C
Drilling
D
Technical Information
E
Index

SU(K) drill 5xD **General machining** Add K (SUK) to the code for use on Cast Iron

1536SU05/1536SU05C



- Type of shank DIN 6535HA
- Coolant exit, axial concentric



External coolant



Internal coolant

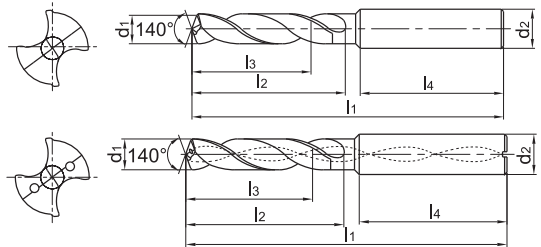

Article	*	Dimensions [mm]						Grade
		d ₁ (m7)	d ₂ (h6)	l ₁	l ₂	l ₃	l ₄	KDG303
1536SU05C-0390	*	3.9	6	74	36	29	36	●
1536SU05-0400		4	6	74	36	29	36	●
1536SU05C-0400	*	4	6	74	36	29	36	●
1536SU05-0410		4.1	6	74	36	29	36	●
1536SU05C-0410	*	4.1	6	74	36	29	36	●
1536SU05-0420		4.2	6	74	36	29	36	●
1536SU05C-0420	*	4.2	6	74	36	29	36	●
1536SU05-0430		4.3	6	74	36	29	36	●
1536SU05C-0430	*	4.3	6	74	36	29	36	●
1536SU05-0440		4.4	6	74	36	29	36	●
1536SU05C-0440	*	4.4	6	74	36	29	36	●
1536SU05-0450		4.5	6	74	36	29	36	●
1536SU05C-0450	*	4.5	6	74	36	29	36	●
1536SU05-0460		4.6	6	74	36	29	36	●
1536SU05C-0460	*	4.6	6	74	36	29	36	●
1536SU05-0465		4.65	6	74	36	29	36	●
1536SU05C-0465	*	4.65	6	74	36	29	36	●
1536SU05-0470		4.7	6	74	36	29	36	●
1536SU05C-0470	*	4.7	6	74	36	29	36	●
1536SU05-0480		4.8	6	82	44	35	36	●
1536SU05C-0480	*	4.8	6	82	44	35	36	●
1536SU05-0490		4.9	6	82	44	35	36	●
1536SU05C-0490	*	4.9	6	82	44	35	36	●
1536SU05-0500		5	6	82	44	35	36	●
1536SU05C-0500	*	5	6	82	44	35	36	●
1536SU05-0510		5.1	6	82	44	35	36	●
1536SU05C-0510	*	5.1	6	82	44	35	36	●
1536SU05-0520		5.2	6	82	44	35	36	●
1536SU05C-0520	*	5.2	6	82	44	35	36	●
1536SU05-0530		5.3	6	82	44	35	36	●
1536SU05C-0530	*	5.3	6	82	44	35	36	●

- Ex stock ○ On demand
- All articles SUK on demand
- * With internal cooling

Application field

Type	P	M	K	N	S	H
1536SU*	✓	✓	✓			
1536SUK*			✓			

- ✓ Very suitable
- ✓ Suitable

System code > C44

Machining instructions > C201

Cutting data > C144

Nonstandard order > C150

SU(K) drill 5xD

General machining

Add K (SUK) to the code for use on Cast Iron

1536SU05/1536SU05C



- Type of shank DIN 6535HA
- Coolant exit, axial concentric



External coolant



Internal coolant

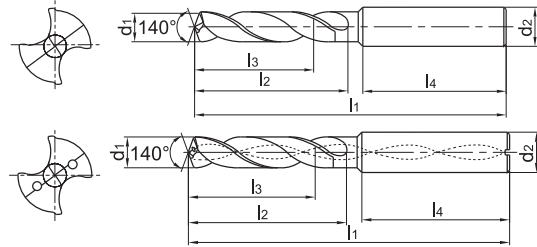

Article	*	Dimensions [mm]						Grade
		d ₁ (m7)	d ₂ (h6)	l ₁	l ₂	l ₃	l ₄	KDG303
1536SU05-0540		5.4	6	82	44	35	36	●
1536SU05C-0540	*	5.4	6	82	44	35	36	●
1536SU05-0550		5.5	6	82	44	35	36	●
1536SU05C-0550	*	5.5	6	82	44	35	36	●
1536SU05-0555		5.55	6	82	44	35	36	●
1536SU05C-0555	*	5.55	6	82	44	35	36	●
1536SU05-0560		5.6	6	82	44	35	36	●
1536SU05C-0560	*	5.6	6	82	44	35	36	●
1536SU05-0570		5.7	6	82	44	35	36	●
1536SU05C-0570	*	5.7	6	82	44	35	36	●
1536SU05-0580		5.8	6	82	44	35	36	●
1536SU05C-0580	*	5.8	6	82	44	35	36	●
1536SU05-0590		5.9	6	82	44	35	36	●
1536SU05C-0590	*	5.9	6	82	44	35	36	●
1536SU05-0600		6	6	82	44	35	36	●
1536SU05C-0600	*	6	6	82	44	35	36	●
1536SU05-0610		6.1	8	91	53	43	36	●
1536SU05C-0610	*	6.1	8	91	53	43	36	●
1536SU05-0620		6.2	8	91	53	43	36	●
1536SU05C-0620	*	6.2	8	91	53	43	36	●
1536SU05-0630		6.3	8	91	53	43	36	●
1536SU05C-0630	*	6.3	8	91	53	43	36	●
1536SU05-0640		6.4	8	91	53	43	36	●
1536SU05C-0640	*	6.4	8	91	53	43	36	●
1536SU05-0650		6.5	8	91	53	43	36	●
1536SU05C-0650	*	6.5	8	91	53	43	36	●
1536SU05-0660		6.6	8	91	53	43	36	●
1536SU05C-0660	*	6.6	8	91	53	43	36	●
1536SU05-0670		6.7	8	91	53	43	36	●
1536SU05C-0670	*	6.7	8	91	53	43	36	●
1536SU05-0675		6.75	8	91	53	43	36	●

● Ex stock ○ On demand

All articles SUK on demand

* With internal cooling

Application field						
Type	P	M	K	N	S	H
1536SU*	✓	✓	✓			
1536SUK*			✓			

✓ Very suitable

✓ Suitable

System code > C44

Machining instructions > C201

Cutting data > C144

Nonstandard order > C150



A

Turning

B

Milling

C

Drilling

D

Technical Information

E

Index

SU(K) drill 5xD **General machining** Add K (SUK) to the code for use on Cast Iron

1536SU05/1536SU05C



- Type of shank DIN 6535HA
- Coolant exit, axial concentric

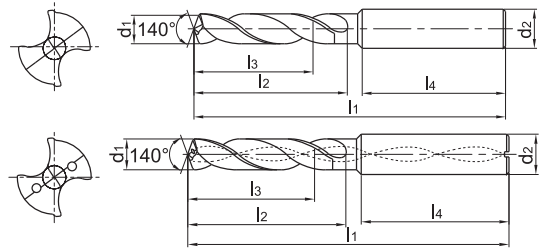
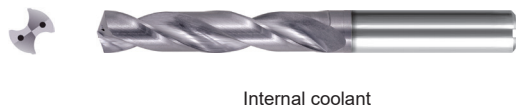
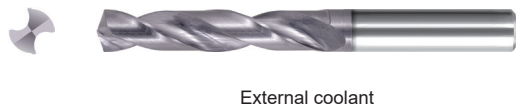

Article	*	Dimensions [mm]						Grade
		d ₁ (m7)	d ₂ (h6)	l ₁	l ₂	l ₃	l ₄	KDG303
1536SU05C-0675	*	6.75	8	91	53	43	36	●
1536SU05-0680		6.8	8	91	53	43	36	●
1536SU05C-0680	*	6.8	8	91	53	43	36	●
1536SU05-0690		6.9	8	91	53	43	36	●
1536SU05C-0690	*	6.9	8	91	53	43	36	●
1536SU05-0700		7	8	91	53	43	36	●
1536SU05C-0700	*	7	8	91	53	43	36	●
1536SU05-0710		7.1	8	91	53	43	36	●
1536SU05C-0710	*	7.1	8	91	53	43	36	●
1536SU05-0720		7.2	8	91	53	43	36	●
1536SU05C-0720	*	7.2	8	91	53	43	36	●
1536SU05-0730		7.3	8	91	53	43	36	●
1536SU05C-0730	*	7.3	8	91	53	43	36	●
1536SU05-0740		7.4	8	91	53	43	36	●
1536SU05C-0740	*	7.4	8	91	53	43	36	●
1536SU05-0745		7.45	8	91	53	43	36	●
1536SU05C-0745	*	7.45	8	91	53	43	36	●
1536SU05-0750		7.5	8	91	53	43	36	●
1536SU05C-0750	*	7.5	8	91	53	43	36	●
1536SU05-0760		7.6	8	91	53	43	36	●
1536SU05C-0760	*	7.6	8	91	53	43	36	●
1536SU05-0770		7.7	8	91	53	43	36	●
1536SU05C-0770	*	7.7	8	91	53	43	36	●
1536SU05-0780		7.8	8	91	53	43	36	●
1536SU05C-0780	*	7.8	8	91	53	43	36	●
1536SU05-0790		7.9	8	91	53	43	36	●
1536SU05C-0790	*	7.9	8	91	53	43	36	●
1536SU05-0800		8	8	91	53	43	36	●
1536SU05C-0800	*	8	8	91	53	43	36	●
1536SU05-0810		8.1	10	103	61	49	40	●
1536SU05C-0810	*	8.1	10	103	61	49	40	●

- Ex stock ○ On demand
- All articles SUK on demand
- * With internal cooling

Application field

Type	P	M	K	N	S	H
1536SU*	✓	✓	✓			
1536SUK*			✓			

- ✓ Very suitable
- ✓ Suitable

System code > C44

Machining instructions > C201

Cutting data > C144

Nonstandard order > C150

SU(K) drill 5xD

General machining

Add K (SUK) to the code for use on Cast Iron

1536SU05/1536SU05C



- Type of shank DIN 6535HA
- Coolant exit, axial concentric

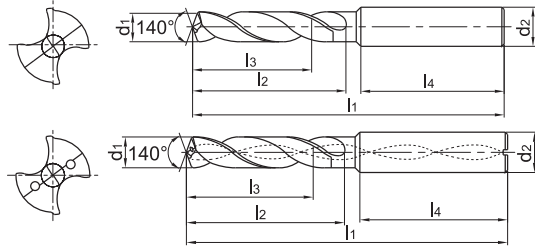
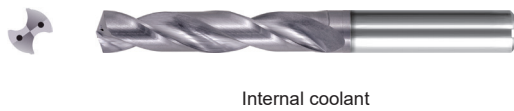

Article	*	Dimensions [mm]						Grade
		d ₁ (m7)	d ₂ (h6)	l ₁	l ₂	l ₃	l ₄	KDG303
1536SU05-0820		8.2	10	103	61	49	40	●
1536SU05C-0820	*	8.2	10	103	61	49	40	●
1536SU05-0830		8.3	10	103	61	49	40	●
1536SU05C-0830	*	8.3	10	103	61	49	40	●
1536SU05-0840		8.4	10	103	61	49	40	●
1536SU05C-0840	*	8.4	10	103	61	49	40	●
1536SU05-0850		8.5	10	103	61	49	40	●
1536SU05C-0850	*	8.5	10	103	61	49	40	●
1536SU05-0860		8.6	10	103	61	49	40	●
1536SU05C-0860	*	8.6	10	103	61	49	40	●
1536SU05-0870		8.7	10	103	61	49	40	●
1536SU05C-0870	*	8.7	10	103	61	49	40	●
1536SU05-0880		8.8	10	103	61	49	40	●
1536SU05C-0880	*	8.8	10	103	61	49	40	●
1536SU05-0890		8.9	10	103	61	49	40	●
1536SU05C-0890	*	8.9	10	103	61	49	40	●
1536SU05-0900		9	10	103	61	49	40	●
1536SU05C-0900	*	9	10	103	61	49	40	●
1536SU05-0910		9.1	10	103	61	49	40	●
1536SU05C-0910	*	9.1	10	103	61	49	40	●
1536SU05-0920		9.2	10	103	61	49	40	●
1536SU05C-0920	*	9.2	10	103	61	49	40	●
1536SU05-0930		9.3	10	103	61	49	40	●
1536SU05C-0930	*	9.3	10	103	61	49	40	●
1536SU05-0935		9.35	10	103	61	49	40	●
1536SU05C-0935	*	9.35	10	103	61	49	40	○
1536SU05-0940		9.4	10	103	61	49	40	●
1536SU05C-0940	*	9.4	10	103	61	49	40	●
1536SU05-0945		9.45	10	103	61	49	40	●
1536SU05C-0945	*	9.45	10	103	61	49	40	○
1536SU05-0950		9.5	10	103	61	49	40	●

● Ex stock ○ On demand

All articles SUK on demand

* With internal cooling

Application field						
Type	P	M	K	N	S	H
1536SU*	✓	✓	✓			
1536SUK*			✓			

- ✓ Very suitable
- ✓ Suitable

System code > C44

Machining instructions > C201

Cutting data > C144

Nonstandard order > C150



A

Turning

B

Milling

C

Drilling

D

Technical Information

E

Index

SU(K) drill 5xD **General machining** Add K (SUK) to the code for use on Cast Iron

1536SU05/1536SU05C



- Type of shank DIN 6535HA
- Coolant exit, axial concentric

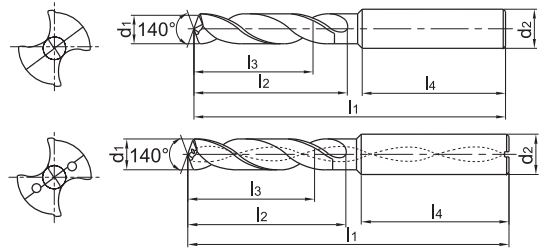
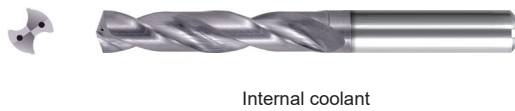

Article	*	Dimensions [mm]						Grade
		d ₁ (m7)	d ₂ (h6)	l ₁	l ₂	l ₃	l ₄	KDG303
1536SU05C-0950	*	9.5	10	103	61	49	40	●
1536SU05-0960		9.6	10	103	61	49	40	●
1536SU05C-0960	*	9.6	10	103	61	49	40	●
1536SU05-0970		9.7	10	103	61	49	40	●
1536SU05C-0970	*	9.7	10	103	61	49	40	●
1536SU05-0980		9.8	10	103	61	49	40	●
1536SU05C-0980	*	9.8	10	103	61	49	40	●
1536SU05-0990		9.9	10	103	61	49	40	●
1536SU05C-0990	*	9.9	10	103	61	49	40	●
1536SU05-1000		10	10	103	61	49	40	●
1536SU05C-1000	*	10	10	103	61	49	40	●
1536SU05-1010		10.1	12	118	71	56	45	●
1536SU05C-1010	*	10.1	12	118	71	56	45	●
1536SU05-1020		10.2	12	118	71	56	45	●
1536SU05C-1020	*	10.2	12	118	71	56	45	●
1536SU05-1025		10.25	12	118	71	56	45	●
1536SU05C-1025	*	10.25	12	118	71	56	45	●
1536SU05-1030		10.3	12	118	71	56	45	●
1536SU05C-1030	*	10.3	12	118	71	56	45	●
1536SU05-1040		10.4	12	118	71	56	45	●
1536SU05C-1040	*	10.4	12	118	71	56	45	●
1536SU05-1050		10.5	12	118	71	56	45	●
1536SU05C-1050	*	10.5	12	118	71	56	45	●
1536SU05-1060		10.6	12	118	71	56	45	●
1536SU05C-1060	*	10.6	12	118	71	56	45	●
1536SU05-1070		10.7	12	118	71	56	45	●
1536SU05C-1070	*	10.7	12	118	71	56	45	●
1536SU05-1080		10.8	12	118	71	56	45	●
1536SU05C-1080	*	10.8	12	118	71	56	45	●
1536SU05-1090		10.9	12	118	71	56	45	●
1536SU05C-1090	*	10.9	12	118	71	56	45	●

- Ex stock ○ On demand
- All articles SUK on demand
- * With internal cooling

Application field

Type	P	M	K	N	S	H
1536SU*	✓	✓	✓			
1536SUK*			✓			

- ✓ Very suitable
- ✓ Suitable

System code > C44

Machining instructions > C201

Cutting data > C144

Nonstandard order > C150

SU(K) drill 5xD

General machining

Add K (SUK) to the code for use on Cast Iron

1536SU05/1536SU05C



- Type of shank DIN 6535HA
- Coolant exit, axial concentric



External coolant



Internal coolant

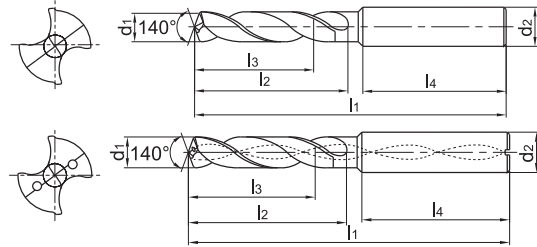

Article	*	Dimensions [mm]						Grade
		d ₁ (m7)	d ₂ (h6)	l ₁	l ₂	l ₃	l ₄	KDG303
1536SU05-1100		11	12	118	71	56	45	●
1536SU05C-1100	*	11	12	118	71	56	45	●
1536SU05-1110		11.1	12	118	71	56	45	●
1536SU05C-1110	*	11.1	12	118	71	56	45	●
1536SU05-1120		11.2	12	118	71	56	45	●
1536SU05C-1120	*	11.2	12	118	71	56	45	●
1536SU05-1125		11.25	12	118	71	56	45	●
1536SU05C-1125	*	11.25	12	118	71	56	45	○
1536SU05-1130		11.3	12	118	71	56	45	●
1536SU05C-1130	*	11.3	12	118	71	56	45	●
1536SU05-1135		11.35	12	118	71	56	45	●
1536SU05C-1135	*	11.35	12	118	71	56	45	○
1536SU05-1140		11.4	12	118	71	56	45	●
1536SU05C-1140	*	11.4	12	118	71	56	45	●
1536SU05-1145		11.45	12	118	71	56	45	○
1536SU05C-1145	*	11.45	12	118	71	56	45	○
1536SU05-1150		11.5	12	118	71	56	45	●
1536SU05C-1150	*	11.5	12	118	71	56	45	●
1536SU05-1160		11.6	12	118	71	56	45	●
1536SU05C-1160	*	11.6	12	118	71	56	45	●
1536SU05-1170		11.7	12	118	71	56	45	●
1536SU05C-1170	*	11.7	12	118	71	56	45	●
1536SU05-1180		11.8	12	118	71	56	45	●
1536SU05C-1180	*	11.8	12	118	71	56	45	●
1536SU05-1190		11.9	12	118	71	56	45	●
1536SU05C-1190	*	11.9	12	118	71	56	45	●
1536SU05-1200		12	12	118	71	56	45	●
1536SU05C-1200	*	12	12	118	71	56	45	●
1536SU05-1210		12.1	14	124	77	60	45	●
1536SU05C-1210	*	12.1	14	124	77	60	45	●
1536SU05-1220		12.2	14	124	77	60	45	●

● Ex stock ○ On demand

All articles SUK on demand

* With internal cooling

Application field						
Type	P	M	K	N	S	H
1536SU*	✓	✓	✓			
1536SUK*			✓			

- ✓ Very suitable
- ✓ Suitable

System code > C44

Machining instructions > C201

Cutting data > C144

Nonstandard order > C150



A

Turning

B

Milling

C

Drilling

D

Technical Information

E

Index

Solid carbide drills SU series

SU(K) drill 5xD **General machining** Add K (SUK) to the code for use on Cast Iron

1536SU05/1536SU05C



- Type of shank DIN 6535HA
- Coolant exit, axial concentric



External coolant



Internal coolant

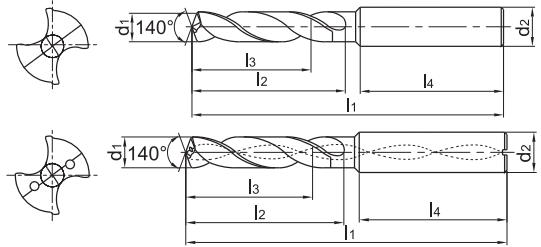

Article	*	Dimensions [mm]						Grade
		d ₁ (m7)	d ₂ (h6)	l ₁	l ₂	l ₃	l ₄	KDG303
1536SU05C-1220	*	12.2	14	124	77	60	45	●
1536SU05-1225		12.25	14	124	77	60	45	●
1536SU05C-1225	*	12.25	14	124	77	60	45	●
1536SU05-1230		12.3	14	124	77	60	45	●
1536SU05C-1230	*	12.3	14	124	77	60	45	●
1536SU05-1250		12.5	14	124	77	60	45	●
1536SU05C-1250	*	12.5	14	124	77	60	45	●
1536SU05-1270		12.7	14	124	77	60	45	●
1536SU05C-1270	*	12.7	14	124	77	60	45	●
1536SU05-1275		12.75	14	124	77	60	45	●
1536SU05C-1275	*	12.75	14	124	77	60	45	●
1536SU05-1280		12.8	14	124	77	60	45	●
1536SU05C-1280	*	12.8	14	124	77	60	45	●
1536SU05-1300		13	14	124	77	60	45	●
1536SU05C-1300	*	13	14	124	77	60	45	●
1536SU05-1310		13.1	14	124	77	60	45	●
1536SU05C-1310	*	13.1	14	124	77	60	45	●
1536SU05-1335		13.35	14	124	77	60	56	○
1536SU05C-1335	*	13.35	14	124	77	60	56	○
1536SU05-1350		13.5	14	124	77	60	45	●
1536SU05C-1350	*	13.5	14	124	77	60	45	●
1536SU05-1380		13.8	14	124	77	60	45	●
1536SU05C-1380	*	13.8	14	124	77	60	45	●
1536SU05-1400		14	14	124	77	60	45	●
1536SU05C-1400	*	14	14	124	77	60	45	●
1536SU05-1420		14.2	16	124	77	60	45	●
1536SU05C-1420	*	14.2	16	124	77	60	45	●
1536SU05-1425		14.25	16	133	83	63	48	●
1536SU05C-1425	*	14.25	16	133	83	63	48	●
1536SU05-1430		14.3	16	133	83	63	48	●
1536SU05C-1430	*	14.3	16	133	83	63	48	●

● Ex stock ○ On demand

All articles SUK on demand

* With internal cooling

Application field

Type	P	M	K	N	S	H
1536SU*	✓	✓	✓			
1536SUK*			✓			

✓ Very suitable

✓ Suitable

System code > C44

Machining instructions > C201

Cutting data > C144

Nonstandard order > C150

SU(K) drill 5xD

General machining

Add K (SUK) to the code for use on Cast Iron

1536SU05/1536SU05C



- Type of shank DIN 6535HA
- Coolant exit, axial concentric



External coolant



Internal coolant

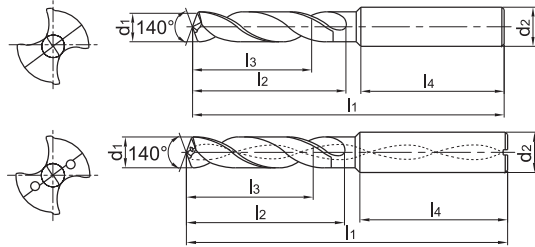

Article	*	Dimensions [mm]						Grade
		d ₁ (m7)	d ₂ (h6)	l ₁	l ₂	l ₃	l ₄	KDG303
1536SU05-1450		14.5	16	133	83	63	48	●
1536SU05C-1450	*	14.5	16	133	83	63	48	●
1536SU05-1475		14.75	16	133	83	63	48	●
1536SU05C-1475	*	14.75	16	133	83	63	48	●
1536SU05-1480		14.8	16	133	83	63	48	●
1536SU05C-1480	*	14.8	16	133	83	63	48	●
1536SU05-1500		15	16	133	83	63	48	●
1536SU05C-1500	*	15	16	133	83	63	48	●
1536SU05-1510		15.1	16	133	83	63	48	●
1536SU05C-1510	*	15.1	16	133	83	63	48	●
1536SU05C-1530	*	15.3	16	133	83	63	48	●
1536SU05-1535		15.35	16	133	83	63	48	○
1536SU05C-1535	*	15.35	16	133	83	63	48	○
1536SU05-1550		15.5	16	133	83	63	48	●
1536SU05C-1550	*	15.5	16	133	83	63	48	●
1536SU05-1580		15.8	16	133	83	63	48	●
1536SU05C-1580	*	15.8	16	133	83	63	48	●
1536SU05-1600		16	16	133	83	63	48	●
1536SU05C-1600	*	16	16	133	83	63	48	●
1536SU05-1650		16.5	18	143	93	71	48	●
1536SU05C-1650	*	16.5	18	143	93	71	48	●
1536SU05-1675		16.75	18	143	93	71	48	●
1536SU05C-1675	*	16.75	18	143	93	71	48	●
1536SU05-1680		16.8	18	143	93	71	48	●
1536SU05C-1680	*	16.8	18	143	93	71	48	●
1536SU05-1700		17	18	143	93	71	48	●
1536SU05C-1700	*	17	18	143	93	71	48	●
1536SU05-1750		17.5	18	143	93	71	48	●
1536SU05C-1750	*	17.5	18	143	93	71	48	●
1536SU05-1780		17.8	18	143	93	71	48	●
1536SU05C-1780	*	17.8	18	143	93	71	48	●

● Ex stock ○ On demand

All articles SUK on demand

* With internal cooling

Application field						
Type	P	M	K	N	S	H
1536SU*	✓	✓	✓			
1536SUK*			✓			

- ✓ Very suitable
- ✓ Suitable

System code > C44

Machining instructions > C201

Cutting data > C144

Nonstandard order > C150



A

Turning

B

Milling

C

Drilling

D

Technical Information

E

Index

SU(K) drill 5xD **General machining** Add K (SUK) to the code for use on Cast Iron

1536SU05/1536SU05C



- Type of shank DIN 6535HA
- Coolant exit, axial concentric



External coolant



Internal coolant

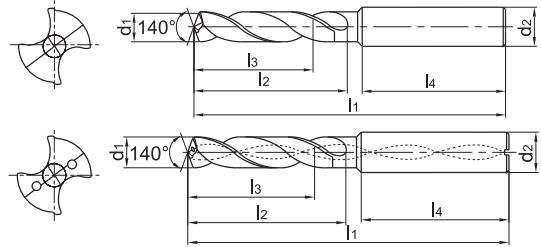

Article	*	Dimensions [mm]						Grade
		d ₁ (m7)	d ₂ (h6)	l ₁	l ₂	l ₃	l ₄	KDG303
1536SU05-1800		18	18	143	93	71	48	●
1536SU05C-1800	*	18	18	143	93	71	48	●
1536SU05-1850		18.5	20	153	101	77	50	●
1536SU05C-1850	*	18.5	20	153	101	77	50	●
1536SU05-1880		18.8	20	153	101	77	50	●
1536SU05C-1880	*	18.8	20	153	101	77	50	●
1536SU05-1900		19	20	153	101	77	50	●
1536SU05C-1900	*	19	20	153	101	77	50	●
1536SU05-1950		19.5	20	153	101	77	50	●
1536SU05C-1950	*	19.5	20	153	101	77	50	●
1536SU05-1980		19.8	20	153	101	77	50	●
1536SU05C-1980	*	19.8	20	153	101	77	50	●
1536SU05-2000		20	20	153	101	77	50	●
1536SU05C-2000	*	20	20	153	101	77	50	●

- Ex stock ○ On demand
- All articles SUK on demand
- * With internal cooling

Application field

Type	P	M	K	N	S	H
1536SU*	✓	✓	✓			
1536SUK*			✓			

- ✓ Very suitable
- ✓ Suitable

System code > C44

Machining instructions > C201

Cutting data > C144

Nonstandard order > C150

SU(K) drill 8xD

General machining

Add K (SUK) to the code for use on Cast Iron

1538SU08C



- Type of shank DIN 6535HA
- Coolant exit, axial concentric



Internal coolant

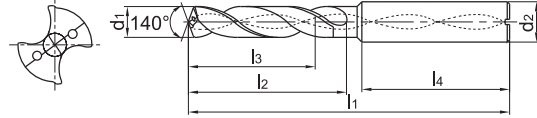

Article	*	Dimensions [mm]						Grade
		d ₁ (m7)	d ₂ (h6)	l ₁	l ₂	l ₃	l ₄	KDG303
1538SU08C-0300	*	3	6	72	34	29	36	●
1538SU08C-0310	*	3.1	6	72	34	29	36	●
1538SU08C-0320	*	3.2	6	72	34	29	36	●
1538SU08C-0330	*	3.3	6	72	34	29	36	●
1538SU08C-0340	*	3.4	6	72	34	29	36	●
1538SU08C-0350	*	3.5	6	72	34	29	36	●
1538SU08C-0360	*	3.6	6	72	34	29	36	●
1538SU08C-0370	*	3.7	6	72	34	29	36	●
1538SU08C-0380	*	3.8	6	81	43	36	36	●
1538SU08C-0390	*	3.9	6	81	43	36	36	●
1538SU08C-0400	*	4	6	81	43	36	36	●
1538SU08C-0410	*	4.1	6	81	43	36	36	●
1538SU08C-0420	*	4.2	6	81	43	36	36	●
1538SU08C-0430	*	4.3	6	81	43	36	36	●
1538SU08C-0440	*	4.4	6	81	43	36	36	●
1538SU08C-0450	*	4.5	6	81	43	36	36	●
1538SU08C-0460	*	4.6	6	81	43	36	36	●
1538SU08C-0470	*	4.7	6	81	43	36	36	●
1538SU08C-0480	*	4.8	6	95	57	48	36	●
1538SU08C-0490	*	4.9	6	95	57	48	36	●
1538SU08C-0500	*	5	6	95	57	48	36	●
1538SU08C-0510	*	5.1	6	95	57	48	36	●
1538SU08C-0520	*	5.2	6	95	57	48	36	●
1538SU08C-0530	*	5.3	6	95	57	48	36	●
1538SU08C-0540	*	5.4	6	95	57	48	36	●
1538SU08C-0550	*	5.5	6	95	57	48	36	●
1538SU08C-0560	*	5.6	6	95	57	48	36	●
1538SU08C-0570	*	5.7	6	95	57	48	36	●
1538SU08C-0580	*	5.8	6	95	57	48	36	●
1538SU08C-0590	*	5.9	6	95	57	48	36	●
1538SU08C-0600	*	6	6	95	57	48	36	●
1538SU08C-0610	*	6.1	8	114	76	66	36	●
1538SU08C-0620	*	6.2	8	114	76	66	36	●
1538SU08C-0630	*	6.3	8	114	76	66	36	●
1538SU08C-0640	*	6.4	8	114	76	66	36	●

● Ex stock ○ On demand

All articles SUK on demand

* With internal cooling

Application field

Type	P	M	K	N	S	H
1538SU*	✓	✓	✓			
1538SUK*			✓			

- ✓ Very suitable
- ✓ Suitable

System code > C44

Machining instructions > C201

Cutting data > C144

Nonstandard order > C150



A

Turning

B

Milling

C

Drilling

D

Technical Information

E

Index

Solid carbide drills SU series

SU(K) drill 8xD

General machining

Add K (SUK) to the code for use on Cast Iron

1538SU08C



- Type of shank DIN 6535HA
- Coolant exit, axial concentric



Internal coolant

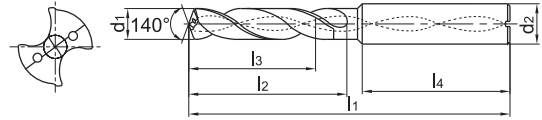

Article	*	Dimensions [mm]						Grade
		d ₁ (m7)	d ₂ (h6)	l ₁	l ₂	l ₃	l ₄	KDG303
1538SU08C-0650	*	6.5	8	114	76	66	36	●
1538SU08C-0660	*	6.6	8	114	76	66	36	●
1538SU08C-0670	*	6.7	8	114	76	66	36	●
1538SU08C-0680	*	6.8	8	114	76	66	36	●
1538SU08C-0690	*	6.9	8	114	76	66	36	●
1538SU08C-0700	*	7	8	116	76	66	36	●
1538SU08C-0710	*	7.1	8	116	76	66	36	●
1538SU08C-0720	*	7.2	8	116	76	66	36	●
1538SU08C-0730	*	7.3	8	116	76	66	36	●
1538SU08C-0740	*	7.4	8	116	76	66	36	●
1538SU08C-0750	*	7.5	8	116	76	66	36	●
1538SU08C-0760	*	7.6	8	116	76	66	36	●
1538SU08C-0770	*	7.7	8	116	76	66	36	●
1538SU08C-0780	*	7.8	8	116	76	66	36	●
1538SU08C-0790	*	7.9	8	116	76	66	36	●
1538SU08C-0800	*	8	8	116	76	66	36	●
1538SU08C-0810	*	8.1	10	142	95	83	40	●
1538SU08C-0820	*	8.2	10	142	95	83	40	●
1538SU08C-0830	*	8.3	10	142	95	83	40	●
1538SU08C-0840	*	8.4	10	142	95	83	40	●
1538SU08C-0850	*	8.5	10	142	95	83	40	●
1538SU08C-0860	*	8.6	10	142	95	83	40	●
1538SU08C-0870	*	8.7	10	142	95	83	40	●
1538SU08C-0880	*	8.8	10	142	95	83	40	●
1538SU08C-0890	*	8.9	10	142	95	83	40	●
1538SU08C-0900	*	9	10	142	95	83	40	●
1538SU08C-0910	*	9.1	10	142	95	83	40	●
1538SU08C-0920	*	9.2	10	142	95	83	40	●
1538SU08C-0930	*	9.3	10	142	95	83	40	●
1538SU08C-0940	*	9.4	10	142	95	83	40	●
1538SU08C-0950	*	9.5	10	142	95	83	40	●
1538SU08C-0960	*	9.6	10	142	95	83	40	●
1538SU08C-0970	*	9.7	10	142	95	83	40	●
1538SU08C-0980	*	9.8	10	142	95	83	40	●
1538SU08C-0990	*	9.9	10	142	95	83	40	●

● Ex stock ○ On demand

All articles SUK on demand

* With internal cooling

Application field

Type	P	M	K	N	S	H
1538SU*	✓	✓	✓			
1538SUK*			✓			

✓ Very suitable

✓ Suitable

System code > C44

Machining instructions > C201

Cutting data > C144

Nonstandard order > C150

SU(K) drill 8xD

General machining

Add K (SUK) to the code for use on Cast Iron

1538SU08C



- Type of shank DIN 6535HA
- Coolant exit, axial concentric



Internal coolant

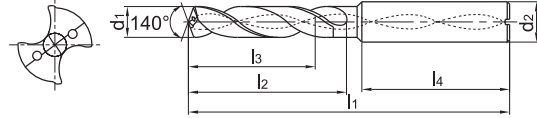

Article	*	Dimensions [mm]						Grade
		d ₁ (m7)	d ₂ (h6)	l ₁	l ₂	l ₃	l ₄	KDG303
1538SU08C-1000	*	10	10	142	95	83	40	●
1538SU08C-1010	*	10.1	12	162	114	99	45	●
1538SU08C-1020	*	10.2	12	162	114	99	45	●
1538SU08C-1030	*	10.3	12	162	114	99	45	●
1538SU08C-1040	*	10.4	12	162	114	99	45	●
1538SU08C-1050	*	10.5	12	162	114	99	45	●
1538SU08C-1060	*	10.6	12	162	114	99	45	●
1538SU08C-1070	*	10.7	12	162	114	99	45	●
1538SU08C-1080	*	10.8	12	162	114	99	45	●
1538SU08C-1090	*	10.9	12	162	114	99	45	●
1538SU08C-1100	*	11	12	162	114	99	45	●
1538SU08C-1110	*	11.1	12	162	114	99	45	●
1538SU08C-1120	*	11.2	12	162	114	99	45	●
1538SU08C-1130	*	11.3	12	162	114	99	45	●
1538SU08C-1140	*	11.4	12	162	114	99	45	●
1538SU08C-1150	*	11.5	12	162	114	99	45	●
1538SU08C-1160	*	11.6	12	162	114	99	45	●
1538SU08C-1170	*	11.7	12	162	114	99	45	●
1538SU08C-1180	*	11.8	12	162	114	99	45	●
1538SU08C-1190	*	11.9	12	162	114	99	45	●
1538SU08C-1200	*	12	12	162	114	99	45	●
1538SU08C-1250	*	12.5	14	178	133	116	45	●
1538SU08C-1270	*	12.7	14	178	133	116	45	●
1538SU08C-1280	*	12.8	14	178	133	116	45	●
1538SU08C-1300	*	13	14	178	133	116	45	●
1538SU08C-1350	*	13.5	14	178	133	116	45	●
1538SU08C-1400	*	14	14	178	133	116	45	●
1538SU08C-1450	*	14.5	16	204	152	132	48	●
1538SU08C-1480	*	14.8	16	204	152	132	48	●
1538SU08C-1500	*	15	16	204	152	132	48	●
1538SU08C-1550	*	15.5	16	204	152	132	48	●
1538SU08C-1600	*	16	16	204	152	132	48	●
1538SU08C-1650	*	16.5	18	223	171	149	48	●
1538SU08C-1700	*	17	18	223	171	149	48	●
1538SU08C-1750	*	17.5	18	223	171	149	48	●
1538SU08C-1800	*	18	18	223	171	149	48	●

- Ex stock ○ On demand
- All articles SUK on demand
- * With internal cooling

Application field						
Type	P	M	K	N	S	H
1538SU*	✓	✓	✓			
1538SUK*			✓			

- ✓ Very suitable
- ✓ Suitable

System code > C44 Machining instructions > C201 Cutting data > C144 Nonstandard order > C150



A
Turning
B
Milling
C
Drilling
D
Technical Information
E
Index

SU(K) drill 3xD

General machining

Add K (SUK) to the code for use on Cast Iron

1634SU03C



- Type of shank: DIN 6535HB
- Coolant exit, axial concentric



Internal coolant

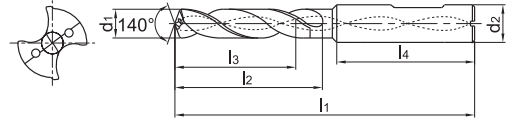

Article	*	Dimensions [mm]						Grade
		d ₁ (m7)	d ₂ (h6)	l ₁	l ₂	l ₃	l ₄	KDG303
1634SU03C-0300	*	3	6	62	20	14	36	●
1634SU03C-0310	*	3.1	6	62	20	14	36	●
1634SU03C-0320	*	3.2	6	62	20	14	36	●
1634SU03C-0325	*	3.25	6	62	20	14	36	○
1634SU03C-0330	*	3.3	6	62	20	14	36	●
1634SU03C-0340	*	3.4	6	62	20	14	36	●
1634SU03C-0350	*	3.5	6	62	20	14	36	●
1634SU03C-0360	*	3.6	6	62	20	14	36	●
1634SU03C-0370	*	3.7	6	62	20	14	36	●
1634SU03C-0380	*	3.8	6	66	24	17	36	●
1634SU03C-0390	*	3.9	6	66	24	17	36	●
1634SU03C-0400	*	4	6	66	24	17	36	●
1634SU03C-0410	*	4.1	6	66	24	17	36	●
1634SU03C-0420	*	4.2	6	66	24	17	36	●
1634SU03C-0430	*	4.3	6	66	24	17	36	●
1634SU03C-0440	*	4.4	6	66	24	17	36	●
1634SU03C-0450	*	4.5	6	66	24	17	36	●
1634SU03C-0460	*	4.6	6	66	24	17	36	●
1634SU03C-0465	*	4.65	6	66	24	17	36	○
1634SU03C-0470	*	4.7	6	66	24	17	36	●
1634SU03C-0480	*	4.8	6	66	28	20	36	●
1634SU03C-0490	*	4.9	6	66	28	20	36	●
1634SU03C-0500	*	5	6	66	28	20	36	●
1634SU03C-0510	*	5.1	6	66	28	20	36	●
1634SU03C-0520	*	5.2	6	66	28	20	36	●
1634SU03C-0530	*	5.3	6	66	28	20	36	●
1634SU03C-0540	*	5.4	6	66	28	20	36	●
1634SU03C-0550	*	5.5	6	66	28	20	36	●
1634SU03C-0555	*	5.55	6	66	28	20	36	●
1634SU03C-0560	*	5.6	6	66	28	20	36	●
1634SU03C-0570	*	5.7	6	66	28	20	36	●
1634SU03C-0580	*	5.8	6	66	28	20	36	●
1634SU03C-0590	*	5.9	6	66	28	20	36	●
1634SU03C-0600	*	6	6	66	28	20	36	●
1634SU03C-0610	*	6.1	8	79	34	24	36	●

● Ex stock ○ On demand

All articles SUK on demand

* With internal cooling

Application field

Type	P	M	K	N	S	H
1634SU*	✓	✓	✓			
1634SUK*			✓			

✓ Very suitable

✓ Suitable

System code > C44

Machining instructions > C201

Cutting data > C144

Nonstandard order > C150

SU(K) drill 3xD

General machining

Add K (SUK) to the code for use on Cast Iron

1634SU03C



- Type of shank: DIN 6535HB
- Coolant exit, axial concentric

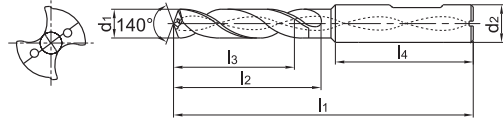
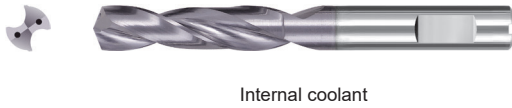

Article	*	Dimensions [mm]						Grade
		d ₁ (m7)	d ₂ (h6)	l ₁	l ₂	l ₃	l ₄	KDG303
1634SU03C-0620	*	6.2	8	79	34	24	36	●
1634SU03C-0630	*	6.3	8	79	34	24	36	●
1634SU03C-0640	*	6.4	8	79	34	24	36	●
1634SU03C-0650	*	6.5	8	79	34	24	36	●
1634SU03C-0660	*	6.6	8	79	34	24	36	●
1634SU03C-0670	*	6.7	8	79	34	24	36	●
1634SU03C-0675	*	6.75	8	79	34	24	36	○
1634SU03C-0680	*	6.8	8	79	34	24	36	●
1634SU03C-0690	*	6.9	8	79	34	24	36	●
1634SU03C-0700	*	7	8	79	34	24	36	●
1634SU03C-0710	*	7.1	8	79	41	29	36	●
1634SU03C-0720	*	7.2	8	79	41	29	36	●
1634SU03C-0730	*	7.3	8	79	41	29	36	●
1634SU03C-0740	*	7.4	8	79	41	29	36	●
1634SU03C-0745	*	7.45	8	79	41	29	36	○
1634SU03C-0750	*	7.5	8	79	41	29	36	●
1634SU03C-0760	*	7.6	8	79	41	29	36	●
1634SU03C-0770	*	7.7	8	79	41	29	36	●
1634SU03C-0780	*	7.8	8	79	41	29	36	●
1634SU03C-0790	*	7.9	8	79	41	29	36	●
1634SU03C-0800	*	8	8	79	41	29	36	●
1634SU03C-0810	*	8.1	10	89	47	35	40	●
1634SU03C-0820	*	8.2	10	89	47	35	40	●
1634SU03C-0830	*	8.3	10	89	47	35	40	●
1634SU03C-0840	*	8.4	10	89	47	35	40	●
1634SU03C-0850	*	8.5	10	89	47	35	40	●
1634SU03C-0860	*	8.6	10	89	47	35	40	●
1634SU03C-0870	*	8.7	10	89	47	35	40	●
1634SU03C-0880	*	8.8	10	89	47	35	40	●
1634SU03C-0890	*	8.9	10	89	47	35	40	●
1634SU03C-0900	*	9	10	89	47	35	40	●
1634SU03C-0910	*	9.1	10	89	47	35	40	●
1634SU03C-0920	*	9.2	10	89	47	35	40	●
1634SU03C-0930	*	9.3	10	89	47	35	40	●
1634SU03C-0935	*	9.35	10	89	47	35	40	○

● Ex stock ○ On demand

All articles SUK on demand

* With internal cooling

Application field						
Type	P	M	K	N	S	H
1634SU*	✓	✓	✓			
1634SUK*			✓			

- ✓ Very suitable
- ✓ Suitable

System code > C44

Machining instructions > C201

Cutting data > C144

Nonstandard order > C150



A

Turning

B

Milling

C

Drilling

D

Technical Information

E

Index

SU(K) drill 3xD

General machining

Add K (SUK) to the code for use on Cast Iron

1634SU03C



- Type of shank: DIN 6535HB
- Coolant exit, axial concentric



Internal coolant

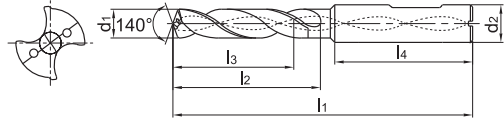

Article	*	Dimensions [mm]						Grade
		d ₁ (m7)	d ₂ (h6)	l ₁	l ₂	l ₃	l ₄	KDG303
1634SU03C-0940	*	9.4	10	89	47	35	40	●
1634SU03C-0945	*	9.45	10	89	47	35	40	○
1634SU03C-0950	*	9.5	10	89	47	35	40	●
1634SU03C-0960	*	9.6	10	89	47	35	40	●
1634SU03C-0970	*	9.7	10	89	47	35	40	●
1634SU03C-0980	*	9.8	10	89	47	35	40	●
1634SU03C-0990	*	9.9	10	89	47	35	40	●
1634SU03C-1000	*	10	10	89	47	35	40	●
1634SU03C-1010	*	10.1	12	102	55	40	45	●
1634SU03C-1020	*	10.2	12	102	55	40	45	●
1634SU03C-1025	*	10.25	12	102	55	40	45	○
1634SU03C-1030	*	10.3	12	102	55	40	45	●
1634SU03C-1040	*	10.4	12	102	55	40	45	●
1634SU03C-1050	*	10.5	12	102	55	40	45	●
1634SU03C-1060	*	10.6	12	102	55	40	45	●
1634SU03C-1070	*	10.7	12	102	55	40	45	●
1634SU03C-1080	*	10.8	12	102	55	40	45	●
1634SU03C-1090	*	10.9	12	102	55	40	45	●
1634SU03C-1100	*	11	12	102	55	40	45	●
1634SU03C-1110	*	11.1	12	102	55	40	45	●
1634SU03C-1120	*	11.2	12	102	55	40	45	●
1634SU03C-1125	*	11.25	12	102	55	40	45	○
1634SU03C-1130	*	11.3	12	102	55	40	45	●
1634SU03C-1135	*	11.35	12	102	55	40	45	○
1634SU03C-1140	*	11.4	12	102	55	40	45	●
1634SU03C-1145	*	11.45	12	102	55	40	45	○
1634SU03C-1150	*	11.5	12	102	55	40	45	●
1634SU03C-1160	*	11.6	12	102	55	40	45	●
1634SU03C-1170	*	11.7	12	102	55	40	45	●
1634SU03C-1180	*	11.8	12	102	55	40	45	●
1634SU03C-1190	*	11.9	12	102	55	40	45	●
1634SU03C-1200	*	12	12	102	55	40	45	●
1634SU03C-1210	*	12.1	14	107	60	43	45	●
1634SU03C-1220	*	12.2	14	107	60	43	45	●
1634SU03C-1225	*	12.25	14	107	60	43	45	○

● Ex stock ○ On demand

All articles SUK on demand

* With internal cooling

Application field

Type	P	M	K	N	S	H
1634SU*	✓	✓	✓			
1634SUK*			✓			

✓ Very suitable

✓ Suitable

System code > C44

Machining instructions > C201

Cutting data > C144

Nonstandard order > C150

SU(K) drill 3xD

General machining

Add K (SUK) to the code for use on Cast Iron

1634SU03C



- Type of shank: DIN 6535HB
- Coolant exit, axial concentric

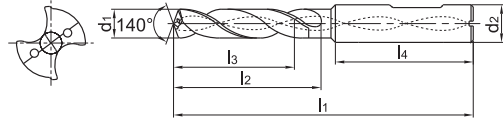
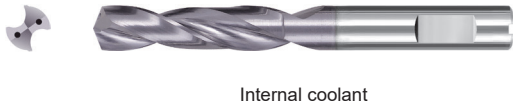

Article	*	Dimensions [mm]						Grade
		d ₁ (m7)	d ₂ (h6)	l ₁	l ₂	l ₃	l ₄	KDG303
1634SU03C-1230	*	12.3	14	107	60	43	45	●
1634SU03C-1250	*	12.5	14	107	60	43	45	●
1634SU03C-1270	*	12.7	14	107	60	43	45	●
1634SU03C-1275	*	12.75	14	107	60	43	45	○
1634SU03C-1280	*	12.8	14	107	60	43	45	●
1634SU03C-1300	*	13	14	107	60	43	45	●
1634SU03C-1310	*	13.1	14	107	60	43	45	●
1634SU03C-1335	*	13.35	14	107	60	43	45	○
1634SU03C-1350	*	13.5	14	107	60	43	45	●
1634SU03C-1380	*	13.8	14	107	60	43	45	●
1634SU03C-1400	*	14	14	107	60	43	45	●
1634SU03C-1420	*	14.2	16	107	60	43	45	○
1634SU03C-1425	*	14.25	16	115	65	45	48	○
1634SU03C-1430	*	14.3	16	115	65	45	48	○
1634SU03C-1450	*	14.5	16	115	65	45	48	●
1634SU03C-1475	*	14.75	16	115	65	45	48	○
1634SU03C-1480	*	14.8	16	115	65	45	48	●
1634SU03C-1500	*	15	16	115	65	45	48	●
1634SU03C-1510	*	15.1	16	115	65	45	48	○
1634SU03C-1535	*	15.35	16	115	65	45	48	○
1634SU03C-1550	*	15.5	16	115	65	45	48	○
1634SU03C-1580	*	15.8	16	115	65	45	48	○
1634SU03C-1600	*	16	16	115	65	45	48	●
1634SU03C-1650	*	16.5	18	123	73	51	48	○
1634SU03C-1675	*	16.75	18	123	73	51	48	○
1634SU03C-1680	*	16.8	18	123	73	51	48	○
1634SU03C-1700	*	17	18	123	73	51	48	●
1634SU03C-1750	*	17.5	18	123	73	51	48	●
1634SU03C-1780	*	17.8	18	123	73	51	48	○
1634SU03C-1800	*	18	18	123	73	51	48	●
1634SU03C-1850	*	18.5	20	131	79	55	50	○
1634SU03C-1880	*	18.8	20	131	79	55	50	○
1634SU03C-1900	*	19	20	131	79	55	50	○
1634SU03C-1950	*	19.5	20	131	79	55	50	●
1634SU03C-1980	*	19.8	20	131	79	55	50	○
1634SU03C-2000	*	20	20	131	79	55	50	●

- Ex stock ○ On demand
- All articles SUK on demand
- * With internal cooling

Application field						
Type	P	M	K	N	S	H
1634SU*	✓	✓	✓			
1634SUK*			✓			

- ✓ Very suitable
- ✓ Suitable



A
Turning
B
Milling
C
Drilling
D
Technical Information
E
Index

SU(K) drill 5xD

General machining

Add K (SUK) to the code for use on Cast Iron

1636SU05C



- Type of shank: DIN 6535HB
- Coolant exit, axial concentric



Internal coolant

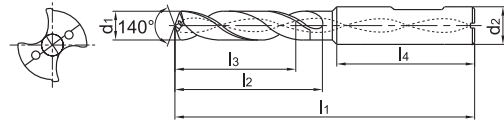

Article	*	Dimensions [mm]						Grade
		d ₁ (m7)	d ₂ (h6)	l ₁	l ₂	l ₃	l ₄	KDG303
1636SU05C-0300	*	3	6	62	20	14	36	●
1636SU05C-0310	*	3.1	6	66	28	23	36	●
1636SU05C-0320	*	3.2	6	66	28	23	36	●
1636SU05C-0325	*	3.25	6	66	28	23	36	○
1636SU05C-0330	*	3.3	6	66	28	23	36	●
1636SU05C-0340	*	3.4	6	66	28	23	36	●
1636SU05C-0350	*	3.5	6	66	28	23	36	●
1636SU05C-0360	*	3.6	6	66	28	23	36	●
1636SU05C-0370	*	3.7	6	66	28	23	36	●
1636SU05C-0380	*	3.8	6	74	36	29	36	●
1636SU05C-0390	*	3.9	6	74	36	29	36	●
1636SU05C-0400	*	4	6	74	36	29	36	●
1636SU05C-0410	*	4.1	6	74	36	29	36	●
1636SU05C-0420	*	4.2	6	74	36	29	36	●
1636SU05C-0430	*	4.3	6	74	36	29	36	●
1636SU05C-0440	*	4.4	6	74	36	29	36	●
1636SU05C-0450	*	4.5	6	74	36	29	36	●
1636SU05C-0460	*	4.6	6	74	36	29	36	●
1636SU05C-0465	*	4.65	6	74	36	29	36	●
1636SU05C-0470	*	4.7	6	74	36	29	36	●
1636SU05C-0480	*	4.8	6	82	44	35	36	●
1636SU05C-0490	*	4.9	6	82	44	35	36	●
1636SU05C-0500	*	5	6	82	44	35	36	●
1636SU05C-0510	*	5.1	6	82	44	35	36	●
1636SU05C-0520	*	5.2	6	82	44	35	36	●
1636SU05C-0530	*	5.3	6	82	44	35	36	●
1636SU05C-0540	*	5.4	6	82	44	35	36	●
1636SU05C-0550	*	5.5	6	82	44	35	36	●
1636SU05C-0555	*	5.55	6	82	44	35	36	●
1636SU05C-0560	*	5.6	6	82	44	35	36	●
1636SU05C-0570	*	5.7	6	82	44	35	36	●
1636SU05C-0580	*	5.8	6	82	44	35	36	●
1636SU05C-0590	*	5.9	6	82	44	35	36	●
1636SU05C-0600	*	6	6	82	44	35	36	●
1636SU05C-0610	*	6.1	8	91	53	43	36	●

● Ex stock ○ On demand

All articles SUK on demand

* With internal cooling

Application field

Type	P	M	K	N	S	H
1636SU*	✓	✓	✓			
1636SUK*			✓			

✓ Very suitable

✓ Suitable

System code > C44

Machining instructions > C201

Cutting data > C144

Nonstandard order > C150

SU(K) drill 5xD

General machining

Add K (SUK) to the code for use on Cast Iron

1636SU05C



- Type of shank: DIN 6535HB
- Coolant exit, axial concentric

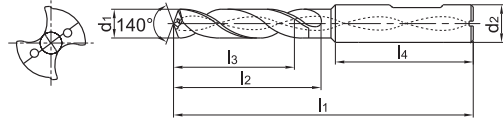

Article	*	Dimensions [mm]						Grade
		d ₁ (m7)	d ₂ (h6)	l ₁	l ₂	l ₃	l ₄	KDG303
1636SU05C-0620	*	6.2	8	91	53	43	36	●
1636SU05C-0630	*	6.3	8	91	53	43	36	●
1636SU05C-0640	*	6.4	8	91	53	43	36	●
1636SU05C-0650	*	6.5	8	91	53	43	36	●
1636SU05C-0660	*	6.6	8	91	53	43	36	●
1636SU05C-0670	*	6.7	8	91	53	43	36	●
1636SU05C-0675	*	6.75	8	91	53	43	36	●
1636SU05C-0680	*	6.8	8	91	53	43	36	●
1636SU05C-0690	*	6.9	8	91	53	43	36	●
1636SU05C-0700	*	7	8	91	53	43	36	●
1636SU05C-0710	*	7.1	8	91	53	43	36	●
1636SU05C-0720	*	7.2	8	91	53	43	36	●
1636SU05C-0730	*	7.3	8	91	53	43	36	●
1636SU05C-0740	*	7.4	8	91	53	43	36	●
1636SU05C-0745	*	7.45	8	91	53	43	36	●
1636SU05C-0750	*	7.5	8	91	53	43	36	●
1636SU05C-0760	*	7.6	8	91	53	43	36	●
1636SU05C-0770	*	7.7	8	91	53	43	36	●
1636SU05C-0780	*	7.8	8	91	53	43	36	●
1636SU05C-0790	*	7.9	8	91	53	43	36	●
1636SU05C-0800	*	8	8	91	53	43	36	●
1636SU05C-0810	*	8.1	10	103	61	49	40	●
1636SU05C-0820	*	8.2	10	103	61	49	40	●
1636SU05C-0830	*	8.3	10	103	61	49	40	●
1636SU05C-0840	*	8.4	10	103	61	49	40	●
1636SU05C-0850	*	8.5	10	103	61	49	40	●
1636SU05C-0860	*	8.6	10	103	61	49	40	●
1636SU05C-0870	*	8.7	10	103	61	49	40	●
1636SU05C-0880	*	8.8	10	103	61	49	40	●
1636SU05C-0890	*	8.9	10	103	61	49	40	●
1636SU05C-0900	*	9	10	103	61	49	40	●
1636SU05C-0910	*	9.1	10	103	61	49	40	●
1636SU05C-0920	*	9.2	10	103	61	49	40	●
1636SU05C-0930	*	9.3	10	103	61	49	40	●
1636SU05C-0935	*	9.35	10	103	61	49	40	○

● Ex stock ○ On demand

All articles SUK on demand

* With internal cooling

Application field						
Type	P	M	K	N	S	H
1636SU*	✓	✓	✓			
1636SUK*			✓			

- ✓ Very suitable
- ✓ Suitable

System code > C44

Machining instructions > C201

Cutting data > C144

Nonstandard order > C150



A

Turning

B

Milling

C

Drilling

D

Technical Information

E

Index

SU(K) drill 5xD

General machining

Add K (SUK) to the code for use on Cast Iron

1636SU05C



- Type of shank: DIN 6535HB
- Coolant exit, axial concentric



Internal coolant

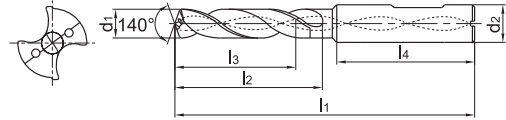

Article	*	Dimensions [mm]						Grade
		d ₁ (m7)	d ₂ (h6)	l ₁	l ₂	l ₃	l ₄	KDG303
1636SU05C-0940	*	9.4	10	103	61	49	40	●
1636SU05C-0945	*	9.45	10	103	61	49	40	○
1636SU05C-0950	*	9.5	10	103	61	49	40	●
1636SU05C-0960	*	9.6	10	103	61	49	40	●
1636SU05C-0970	*	9.7	10	103	61	49	40	●
1636SU05C-0980	*	9.8	10	103	61	49	40	●
1636SU05C-0990	*	9.9	10	103	61	49	40	●
1636SU05C-1000	*	10	10	103	61	49	40	●
1636SU05C-1010	*	10.1	12	118	71	56	45	●
1636SU05C-1020	*	10.2	12	118	71	56	45	●
1636SU05C-1025	*	10.25	12	118	71	56	45	●
1636SU05C-1030	*	10.3	12	118	71	56	45	●
1636SU05C-1040	*	10.4	12	118	71	56	45	●
1636SU05C-1050	*	10.5	12	118	71	56	45	●
1636SU05C-1060	*	10.6	12	118	71	56	45	●
1636SU05C-1070	*	10.7	12	118	71	56	45	●
1636SU05C-1080	*	10.8	12	118	71	56	45	●
1636SU05C-1090	*	10.9	12	118	71	56	45	●
1636SU05C-1100	*	11	12	118	71	56	45	●
1636SU05C-1110	*	11.1	12	118	71	56	45	●
1636SU05C-1120	*	11.2	12	118	71	56	45	●
1636SU05C-1125	*	11.25	12	118	71	56	45	○
1636SU05C-1130	*	11.3	12	118	71	56	45	●
1636SU05C-1135	*	11.35	12	118	71	56	45	○
1636SU05C-1140	*	11.4	12	118	71	56	45	●
1636SU05C-1145	*	11.45	12	118	71	56	45	○
1636SU05C-1150	*	11.5	12	118	71	56	45	●
1636SU05C-1160	*	11.6	12	118	71	56	45	●
1636SU05C-1170	*	11.7	12	118	71	56	45	●
1636SU05C-1180	*	11.8	12	118	71	56	45	●
1636SU05C-1190	*	11.9	12	118	71	56	45	●
1636SU05C-1200	*	12	12	118	71	56	45	●
1636SU05C-1210	*	12.1	14	124	77	60	45	●
1636SU05C-1220	*	12.2	14	124	77	60	45	●
1636SU05C-1225	*	12.25	14	124	77	60	45	●

● Ex stock ○ On demand

All articles SUK on demand

* With internal cooling

Application field

Type	P	M	K	N	S	H
1636SU*	✓	✓	✓			
1636SUK*			✓			

✓ Very suitable

✓ Suitable

System code > C44

Machining instructions > C201

Cutting data > C144

Nonstandard order > C150

SU(K) drill 5xD

General machining

Add K (SUK) to the code for use on Cast Iron

1636SU05C



- Type of shank: DIN 6535HB
- Coolant exit, axial concentric

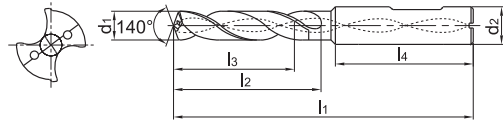

Article	*	Dimensions [mm]						Grade
		d ₁ (m7)	d ₂ (h6)	l ₁	l ₂	l ₃	l ₄	KDG303
1636SU05C-1230	*	12.3	14	124	77	60	45	●
1636SU05C-1250	*	12.5	14	124	77	60	45	●
1636SU05C-1270	*	12.7	14	124	77	60	45	●
1636SU05C-1275	*	12.75	14	124	77	60	45	○
1636SU05C-1280	*	12.8	14	124	77	60	45	●
1636SU05C-1300	*	13	14	124	77	60	45	●
1636SU05C-1310	*	13.1	14	124	77	60	45	●
1636SU05C-1335	*	13.35	14	124	77	60	56	○
1636SU05C-1350	*	13.5	14	124	77	60	45	●
1636SU05C-1380	*	13.8	14	124	77	60	45	●
1636SU05C-1400	*	14	14	124	77	60	45	●
1636SU05C-1420	*	14.2	16	124	77	60	45	●
1636SU05C-1425	*	14.25	16	133	83	63	48	●
1636SU05C-1430	*	14.3	16	133	83	63	48	●
1636SU05C-1450	*	14.5	16	133	83	63	48	●
1636SU05C-1475	*	14.75	16	133	83	63	48	○
1636SU05C-1480	*	14.8	16	133	83	63	48	●
1636SU05C-1500	*	15	16	133	83	63	48	●
1636SU05C-1510	*	15.1	16	133	83	63	48	●
1636SU05C-1535	*	15.35	16	133	83	63	48	○
1636SU05C-1550	*	15.5	16	133	83	63	48	●
1636SU05C-1580	*	15.8	16	133	83	63	48	●
1636SU05C-1600	*	16	16	133	83	63	48	●
1636SU05C-1650	*	16.5	18	143	93	71	48	●
1636SU05C-1675	*	16.75	18	143	93	71	48	○
1636SU05C-1680	*	16.8	18	143	93	71	48	●
1636SU05C-1700	*	17	18	143	93	71	48	●
1636SU05C-1750	*	17.5	18	143	93	71	48	●
1636SU05C-1780	*	17.8	18	143	93	71	48	●
1636SU05C-1800	*	18	18	143	93	71	48	●
1636SU05C-1850	*	18.5	20	153	101	77	50	●
1636SU05C-1880	*	18.8	20	153	101	77	50	●
1636SU05C-1900	*	19	20	153	101	77	50	●
1636SU05C-1950	*	19.5	20	153	101	77	50	●
1636SU05C-1980	*	19.8	20	153	101	77	50	●
1636SU05C-2000	*	20	20	153	101	77	50	●

● Ex stock ○ On demand

All articles SUK on demand

* With internal cooling

Application field						
Type	P	M	K	N	S	H
1636SU*	✓	✓	✓			
1636SUK*			✓			

- ✓ Very suitable
- ✓ Suitable

System code > C44

Machining instructions > C201

Cutting data > C144

Nonstandard order > C150



A

Turning

B

Milling

C

Drilling

D

Technical Information

E

Index

SU(K) drill 3xD **General machining** Add K (SUK) to the code for use on Cast Iron

1734SU03C



- Whistle Notch clamping surface
- Coolant exit, axial concentric



Internal coolant

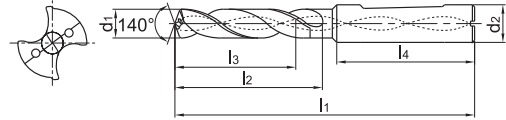

Article	*	Dimensions [mm]						Grade
		d ₁ (m7)	d ₂ (h6)	l ₁	l ₂	l ₃	l ₄	KDG303
1734SU03C-0300	*	3	6	66	28	23	36	●
1734SU03C-0310	*	3.1	6	62	20	14	36	●
1734SU03C-0320	*	3.2	6	62	20	14	36	●
1734SU03C-0325	*	3.25	6	62	20	14	36	○
1734SU03C-0330	*	3.3	6	62	20	14	36	●
1734SU03C-0340	*	3.4	6	62	20	14	36	●
1734SU03C-0350	*	3.5	6	62	20	14	36	●
1734SU03C-0360	*	3.6	6	62	20	14	36	●
1734SU03C-0370	*	3.7	6	62	20	14	36	●
1734SU03C-0380	*	3.8	6	66	24	17	36	●
1734SU03C-0390	*	3.9	6	66	24	17	36	●
1734SU03C-0400	*	4	6	66	24	17	36	●
1734SU03C-0410	*	4.1	6	66	24	17	36	●
1734SU03C-0420	*	4.2	6	66	24	17	36	●
1734SU03C-0430	*	4.3	6	66	24	17	36	●
1734SU03C-0440	*	4.4	6	66	24	17	36	●
1734SU03C-0450	*	4.5	6	66	24	17	36	●
1734SU03C-0460	*	4.6	6	66	24	17	36	●
1734SU03C-0465	*	4.65	6	66	24	17	36	○
1734SU03C-0470	*	4.7	6	66	24	17	36	●
1734SU03C-0480	*	4.8	6	66	28	20	36	●
1734SU03C-0490	*	4.9	6	66	28	20	36	●
1734SU03C-0500	*	5	6	66	28	20	36	●
1734SU03C-0510	*	5.1	6	66	28	20	36	●
1734SU03C-0520	*	5.2	6	66	28	20	36	●
1734SU03C-0530	*	5.3	6	66	28	20	36	●
1734SU03C-0540	*	5.4	6	66	28	20	36	●
1734SU03C-0550	*	5.5	6	66	28	20	36	●
1734SU03C-0555	*	5.55	6	66	28	20	36	●
1734SU03C-0560	*	5.6	6	66	28	20	36	●
1734SU03C-0570	*	5.7	6	66	28	20	36	●
1734SU03C-0580	*	5.8	6	66	28	20	36	●
1734SU03C-0590	*	5.9	6	66	28	20	36	●
1734SU03C-0600	*	6	6	66	28	20	36	●
1734SU03C-0610	*	6.1	8	79	34	24	36	●

● Ex stock ○ On demand

All articles SUK on demand

* With internal cooling

Application field

Type	P	M	K	N	S	H
1734SU*	✓	✓	✓			
1734SUK*			✓			

✓ Very suitable

✓ Suitable

System code > C44

Machining instructions > C201

Cutting data > C144

Nonstandard order > C150

SU(K) drill 3xD

General machining

Add K (SUK) to the code for use on Cast Iron

1734SU03C



- Whistle Notch clamping surface
- Coolant exit, axial concentric

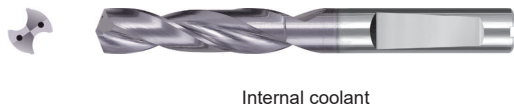

Internal coolant

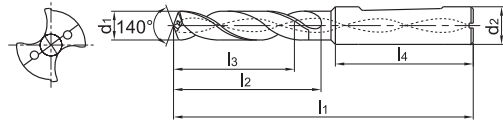

Article	*	Dimensions [mm]						Grade
		d ₁ (m7)	d ₂ (h6)	l ₁	l ₂	l ₃	l ₄	KDG303
1734SU03C-0620	*	6.2	8	79	34	24	36	●
1734SU03C-0630	*	6.3	8	79	34	24	36	●
1734SU03C-0640	*	6.4	8	79	34	24	36	●
1734SU03C-0650	*	6.5	8	79	34	24	36	●
1734SU03C-0660	*	6.6	8	79	34	24	36	●
1734SU03C-0670	*	6.7	8	79	34	24	36	●
1734SU03C-0675	*	6.75	8	79	34	24	36	●
1734SU03C-0680	*	6.8	8	79	34	24	36	●
1734SU03C-0690	*	6.9	8	79	34	24	36	●
1734SU03C-0700	*	7	8	79	34	24	36	●
1734SU03C-0710	*	7.1	8	79	41	29	36	●
1734SU03C-0720	*	7.2	8	79	41	29	36	●
1734SU03C-0730	*	7.3	8	79	41	29	36	●
1734SU03C-0740	*	7.4	8	79	41	29	36	●
1734SU03C-0745	*	7.45	8	79	41	29	36	○
1734SU03C-0750	*	7.5	8	79	41	29	36	●
1734SU03C-0760	*	7.6	8	79	41	29	36	●
1734SU03C-0770	*	7.7	8	79	41	29	36	●
1734SU03C-0780	*	7.8	8	79	41	29	36	●
1734SU03C-0790	*	7.9	8	79	41	29	36	●
1734SU03C-0800	*	8	8	79	41	29	36	●
1734SU03C-0810	*	8.1	10	89	47	35	40	●
1734SU03C-0820	*	8.2	10	89	47	35	40	●
1734SU03C-0830	*	8.3	10	89	47	35	40	●
1734SU03C-0840	*	8.4	10	89	47	35	40	●
1734SU03C-0850	*	8.5	10	89	47	35	40	●
1734SU03C-0860	*	8.6	10	89	47	35	40	●
1734SU03C-0870	*	8.7	10	89	47	35	40	●
1734SU03C-0880	*	8.8	10	89	47	35	40	●
1734SU03C-0890	*	8.9	10	89	47	35	40	●
1734SU03C-0900	*	9	10	89	47	35	40	●
1734SU03C-0910	*	9.1	10	89	47	35	40	●
1734SU03C-0920	*	9.2	10	89	47	35	40	●
1734SU03C-0930	*	9.3	10	89	47	35	40	●
1734SU03C-0935	*	9.35	10	89	47	35	40	○

● Ex stock ○ On demand

All articles SUK on demand

* With internal cooling

Application field

Type	P	M	K	N	S	H
1734SU*	✓	✓	✓			
1734SUK*			✓			

- ✓ Very suitable
- ✓ Suitable

System code > C44

Machining instructions > C201

Cutting data > C144

Nonstandard order > C150



A

Turning

B

Milling

C

Drilling

D

Technical Information

E

Index

SU(K) drill 3xD General machining Add K (SUK) to the code for use on Cast Iron

1734SU03C



- Whistle Notch clamping surface
- Coolant exit, axial concentric



Internal coolant

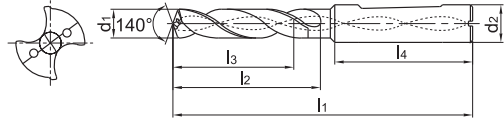

Article	*	Dimensions [mm]						Grade
		d ₁ (m7)	d ₂ (h6)	l ₁	l ₂	l ₃	l ₄	KDG303
1734SU03C-0940	*	9.4	10	89	47	35	40	●
1734SU03C-0945	*	9.45	10	89	47	35	40	○
1734SU03C-0950	*	9.5	10	89	47	35	40	●
1734SU03C-0960	*	9.6	10	89	47	35	40	●
1734SU03C-0970	*	9.7	10	89	47	35	40	●
1734SU03C-0980	*	9.8	10	89	47	35	40	●
1734SU03C-0990	*	9.9	10	89	47	35	40	●
1734SU03C-1000	*	10	10	89	47	35	40	●
1734SU03C-1010	*	10.1	12	102	55	40	45	●
1734SU03C-1020	*	10.2	12	102	55	40	45	●
1734SU03C-1025	*	10.25	12	102	55	40	45	●
1734SU03C-1030	*	10.3	12	102	55	40	45	●
1734SU03C-1040	*	10.4	12	102	55	40	45	●
1734SU03C-1050	*	10.5	12	102	55	40	45	●
1734SU03C-1060	*	10.6	12	102	55	40	45	●
1734SU03C-1070	*	10.7	12	102	55	40	45	●
1734SU03C-1080	*	10.8	12	102	55	40	45	●
1734SU03C-1090	*	10.9	12	102	55	40	45	●
1734SU03C-1100	*	11	12	102	55	40	45	●
1734SU03C-1110	*	11.1	12	102	55	40	45	●
1734SU03C-1120	*	11.2	12	102	55	40	45	●
1734SU03C-1125	*	11.25	12	102	55	40	45	○
1734SU03C-1130	*	11.3	12	102	55	40	45	●
1734SU03C-1135	*	11.35	12	102	55	40	45	○
1734SU03C-1140	*	11.4	12	102	55	40	45	●
1734SU03C-1145	*	11.45	12	102	55	40	45	○
1734SU03C-1150	*	11.5	12	102	55	40	45	●
1734SU03C-1160	*	11.6	12	102	55	40	45	●
1734SU03C-1170	*	11.7	12	102	55	40	45	●
1734SU03C-1180	*	11.8	12	102	55	40	45	●
1734SU03C-1190	*	11.9	12	102	55	40	45	●
1734SU03C-1200	*	12	12	102	55	40	45	●
1734SU03C-1210	*	12.1	14	107	60	43	45	●
1734SU03C-1220	*	12.2	14	107	60	43	45	●
1734SU03C-1225	*	12.25	14	107	60	43	45	●

● Ex stock ○ On demand

All articles SUK on demand

* With internal cooling

Application field

Type	P	M	K	N	S	H
1734SU*	✓	✓	✓			
1734SUK*			✓			

✓ Very suitable

✓ Suitable

System code > C44

Machining instructions > C201

Cutting data > C144

Nonstandard order > C150

SU(K) drill 3xD

General machining

Add K (SUK) to the code for use on Cast Iron

1734SU03C



- Whistle Notch clamping surface
- Coolant exit, axial concentric

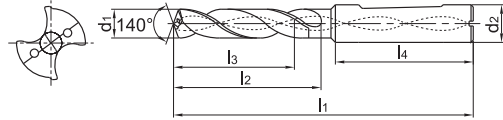
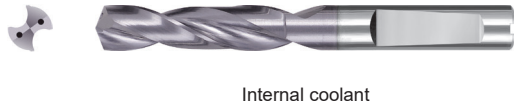

Article	*	Dimensions [mm]						Grade
		d ₁ (m7)	d ₂ (h6)	l ₁	l ₂	l ₃	l ₄	KDG303
1734SU03C-1230	*	12.3	14	107	60	43	45	●
1734SU03C-1250	*	12.5	14	107	60	43	45	●
1734SU03C-1270	*	12.7	14	107	60	43	45	●
1734SU03C-1275	*	12.75	14	107	60	43	45	●
1734SU03C-1280	*	12.8	14	107	60	43	45	●
1734SU03C-1300	*	13	14	107	60	43	45	●
1734SU03C-1310	*	13.1	14	107	60	43	45	●
1734SU03C-1335	*	13.35	14	107	60	43	45	○
1734SU03C-1350	*	13.5	14	107	60	43	45	●
1734SU03C-1380	*	13.8	14	107	60	43	45	●
1734SU03C-1400	*	14	14	107	60	43	45	●
1734SU03C-1420	*	14.2	16	107	60	43	45	●
1734SU03C-1425	*	14.25	16	115	65	45	48	●
1734SU03C-1430	*	14.3	16	115	65	45	48	●
1734SU03C-1450	*	14.5	16	115	65	45	48	●
1734SU03C-1475	*	14.75	16	115	65	45	48	●
1734SU03C-1480	*	14.8	16	115	65	45	48	●
1734SU03C-1500	*	15	16	115	65	45	48	●
1734SU03C-1510	*	15.1	16	115	65	45	48	●
1734SU03C-1535	*	15.35	16	115	65	45	48	○
1734SU03C-1550	*	15.5	16	115	65	45	48	●
1734SU03C-1580	*	15.8	16	115	65	45	48	●
1734SU03C-1600	*	16	16	115	65	45	48	●
1734SU03C-1650	*	16.5	18	123	73	51	48	●
1734SU03C-1675	*	16.75	18	123	73	51	48	●
1734SU03C-1680	*	16.8	18	123	73	51	48	●
1734SU03C-1700	*	17	18	123	73	51	48	●
1734SU03C-1750	*	17.5	18	123	73	51	48	●
1734SU03C-1780	*	17.8	18	123	73	51	48	●
1734SU03C-1800	*	18	18	123	73	51	48	●
1734SU03C-1850	*	18.5	20	131	79	55	50	●
1734SU03C-1880	*	18.8	20	131	79	55	50	●
1734SU03C-1900	*	19	20	131	79	55	50	●
1734SU03C-1950	*	19.5	20	131	79	55	50	●
1734SU03C-1980	*	19.8	20	131	79	55	50	●
1734SU03C-2000	*	20	20	131	79	55	50	●

- Ex stock ○ On demand
- All articles SUK on demand
- * With internal cooling

Application field						
Type	P	M	K	N	S	H
1734SU*	✓	✓	✓			
1734SUK*			✓			

- ✓ Very suitable
- ✓ Suitable

System code > C44 Machining instructions > C201 Cutting data > C144 Nonstandard order > C150



A
Turning
B
Milling
C
Drilling
D
Technical Information
E
Index

SU(K) drill 5xD

General machining

Add K (SUK) to the code for use on Cast Iron

1736SU05C



- Whistle Notch clamping surface
- Coolant exit, axial concentric



Internal coolant

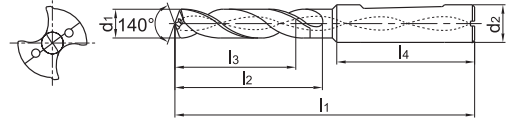

Article	*	Dimensions [mm]						Grade
		d ₁ (m7)	d ₂ (h6)	l ₁	l ₂	l ₃	l ₄	KDG303
1736SU05C-0300	*	3	6	66	28	23	36	●
1736SU05C-0310	*	3.1	6	66	28	23	36	●
1736SU05C-0320	*	3.2	6	66	28	23	36	●
1736SU05C-0325	*	3.25	6	66	28	23	36	○
1736SU05C-0330	*	3.3	6	66	28	23	36	●
1736SU05C-0340	*	3.4	6	66	28	23	36	●
1736SU05C-0350	*	3.5	6	66	28	23	36	●
1736SU05C-0360	*	3.6	6	66	28	23	36	●
1736SU05C-0370	*	3.7	6	66	28	23	36	●
1736SU05C-0380	*	3.8	6	74	36	29	36	●
1736SU05C-0390	*	3.9	6	74	36	29	36	●
1736SU05C-0400	*	4	6	74	36	29	36	●
1736SU05C-0410	*	4.1	6	74	36	29	36	●
1736SU05C-0420	*	4.2	6	74	36	29	36	●
1736SU05C-0430	*	4.3	6	74	36	29	36	●
1736SU05C-0440	*	4.4	6	74	36	29	36	●
1736SU05C-0450	*	4.5	6	74	36	29	36	●
1736SU05C-0460	*	4.6	6	74	36	29	36	●
1736SU05C-0465	*	4.65	6	74	36	29	36	○
1736SU05C-0470	*	4.7	6	74	36	29	36	●
1736SU05C-0480	*	4.8	6	82	44	35	36	●
1736SU05C-0490	*	4.9	6	82	44	35	36	●
1736SU05C-0500	*	5	6	82	44	35	36	●
1736SU05C-0510	*	5.1	6	82	44	35	36	●
1736SU05C-0520	*	5.2	6	82	44	35	36	●
1736SU05C-0530	*	5.3	6	82	44	35	36	●
1736SU05C-0540	*	5.4	6	82	44	35	36	●
1736SU05C-0550	*	5.5	6	82	44	35	36	●
1736SU05C-0555	*	5.55	6	82	44	35	36	●
1736SU05C-0560	*	5.6	6	82	44	35	36	●
1736SU05C-0570	*	5.7	6	82	44	35	36	●
1736SU05C-0580	*	5.8	6	82	44	35	36	●
1736SU05C-0590	*	5.9	6	82	44	35	36	●
1736SU05C-0600	*	6	6	82	44	35	36	●
1736SU05C-0610	*	6.1	8	91	53	43	36	●

● Ex stock ○ On demand

All articles SUK on demand

* With internal cooling

Application field

Type	P	M	K	N	S	H
1736SU*	✓	✓	✓			
1736SUK*			✓			

✓ Very suitable

✓ Suitable

System code > C44

Machining instructions > C201

Cutting data > C144

Nonstandard order > C150

SU(K) drill 5xD

General machining

Add K (SUK) to the code for use on Cast Iron

1736SU05C



- Whistle Notch clamping surface
- Coolant exit, axial concentric

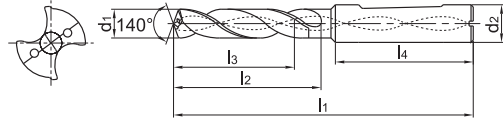
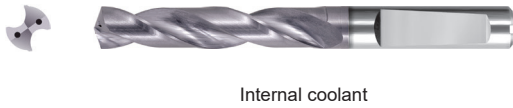

Article	*	Dimensions [mm]						Grade
		d ₁ (m7)	d ₂ (h6)	l ₁	l ₂	l ₃	l ₄	KDG303
1736SU05C-0620	*	6.2	8	91	53	43	36	●
1736SU05C-0630	*	6.3	8	91	53	43	36	●
1736SU05C-0640	*	6.4	8	91	53	43	36	●
1736SU05C-0650	*	6.5	8	91	53	43	36	●
1736SU05C-0660	*	6.6	8	91	53	43	36	●
1736SU05C-0670	*	6.7	8	91	53	43	36	●
1736SU05C-0675	*	6.75	8	91	53	43	36	●
1736SU05C-0680	*	6.8	8	91	53	43	36	●
1736SU05C-0690	*	6.9	8	91	53	43	36	●
1736SU05C-0700	*	7	8	91	53	43	36	●
1736SU05C-0710	*	7.1	8	91	53	43	36	●
1736SU05C-0720	*	7.2	8	91	53	43	36	●
1736SU05C-0730	*	7.3	8	91	53	43	36	●
1736SU05C-0740	*	7.4	8	91	53	43	36	●
1736SU05C-0745	*	7.45	8	91	53	43	36	○
1736SU05C-0750	*	7.5	8	91	53	43	36	●
1736SU05C-0760	*	7.6	8	91	53	43	36	●
1736SU05C-0770	*	7.7	8	91	53	43	36	●
1736SU05C-0780	*	7.8	8	91	53	43	36	●
1736SU05C-0790	*	7.9	8	91	53	43	36	●
1736SU05C-0800	*	8	8	91	53	43	36	●
1736SU05C-0810	*	8.1	10	103	61	49	40	●
1736SU05C-0820	*	8.2	10	103	61	49	40	●
1736SU05C-0830	*	8.3	10	103	61	49	40	●
1736SU05C-0840	*	8.4	10	103	61	49	40	●
1736SU05C-0850	*	8.5	10	103	61	49	40	●
1736SU05C-0860	*	8.6	10	103	61	49	40	●
1736SU05C-0870	*	8.7	10	103	61	49	40	●
1736SU05C-0880	*	8.8	10	103	61	49	40	●
1736SU05C-0890	*	8.9	10	103	61	49	40	●
1736SU05C-0900	*	9	10	103	61	49	40	●
1736SU05C-0910	*	9.1	10	103	61	49	40	●
1736SU05C-0920	*	9.2	10	103	61	49	40	●
1736SU05C-0930	*	9.3	10	103	61	49	40	●
1736SU05C-0935	*	9.35	10	103	61	49	40	○

● Ex stock ○ On demand

All articles SUK on demand

* With internal cooling

Application field						
Type	P	M	K	N	S	H
1736SU*	✓	✓	✓			
1736SUK*			✓			

- ✓ Very suitable
- ✓ Suitable

System code > C44

Machining instructions > C201

Cutting data > C144

Nonstandard order > C150



A

Turning

B

Milling

C

Drilling

D

Technical Information

E

Index

SU(K) drill 5xD

General machining

Add K (SUK) to the code for use on Cast Iron

1736SU05C



- Whistle Notch clamping surface
- Coolant exit, axial concentric



Internal coolant

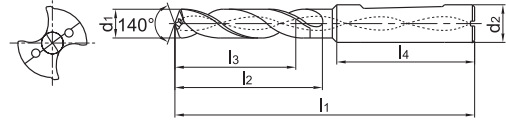

Article	*	Dimensions [mm]						Grade
		d ₁ (m7)	d ₂ (h6)	l ₁	l ₂	l ₃	l ₄	KDG303
1736SU05C-0940	*	9.4	10	103	61	49	40	●
1736SU05C-0945	*	9.45	10	103	61	49	40	○
1736SU05C-0950	*	9.5	10	103	61	49	40	●
1736SU05C-0960	*	9.6	10	103	61	49	40	●
1736SU05C-0970	*	9.7	10	103	61	49	40	●
1736SU05C-0980	*	9.8	10	103	61	49	40	●
1736SU05C-0990	*	9.9	10	103	61	49	40	●
1736SU05C-1000	*	10	10	103	61	49	40	●
1736SU05C-1010	*	10.1	12	118	71	56	45	●
1736SU05C-1020	*	10.2	12	118	71	56	45	●
1736SU05C-1025	*	10.25	12	118	71	56	45	●
1736SU05C-1030	*	10.3	12	118	71	56	45	●
1736SU05C-1040	*	10.4	12	118	71	56	45	●
1736SU05C-1050	*	10.5	12	118	71	56	45	●
1736SU05C-1060	*	10.6	12	118	71	56	45	●
1736SU05C-1070	*	10.7	12	118	71	56	45	●
1736SU05C-1080	*	10.8	12	118	71	56	45	●
1736SU05C-1090	*	10.9	12	118	71	56	45	●
1736SU05C-1100	*	11	12	118	71	56	45	●
1736SU05C-1110	*	11.1	12	118	71	56	45	●
1736SU05C-1120	*	11.2	12	118	71	56	45	●
1736SU05C-1125	*	11.25	12	118	71	56	45	○
1736SU05C-1130	*	11.3	12	118	71	56	45	●
1736SU05C-1135	*	11.35	12	118	71	56	45	○
1736SU05C-1140	*	11.4	12	118	71	56	45	●
1736SU05C-1145	*	11.45	12	118	71	56	45	○
1736SU05C-1150	*	11.5	12	118	71	56	45	●
1736SU05C-1160	*	11.6	12	118	71	56	45	●
1736SU05C-1170	*	11.7	12	118	71	56	45	●
1736SU05C-1180	*	11.8	12	118	71	56	45	●
1736SU05C-1190	*	11.9	12	118	71	56	45	●
1736SU05C-1200	*	12	12	118	71	56	45	●
1736SU05C-1210	*	12.1	14	124	77	60	45	●
1736SU05C-1220	*	12.2	14	124	77	60	45	●
1736SU05C-1225	*	12.25	14	124	77	60	45	○

● Ex stock ○ On demand

All articles SUK on demand

* With internal cooling

Application field

Type	P	M	K	N	S	H
1736SU*	✓	✓	✓			
1736SUK*			✓			

✓ Very suitable

✓ Suitable

System code > C44

Machining instructions > C201

Cutting data > C144

Nonstandard order > C150

SU(K) drill 5xD

General machining

Add K (SUK) to the code for use on Cast Iron

1736SU05C



- Whistle Notch clamping surface
- Coolant exit, axial concentric



Internal coolant

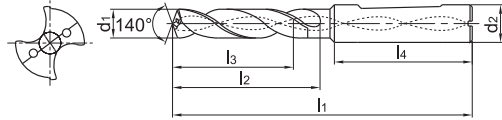

Article	*	Dimensions [mm]						Grade
		d ₁ (m7)	d ₂ (h6)	l ₁	l ₂	l ₃	l ₄	KDG303
1736SU05C-1230	*	12.3	14	124	77	60	45	●
1736SU05C-1250	*	12.5	14	124	77	60	45	●
1736SU05C-1270	*	12.7	14	124	77	60	45	●
1736SU05C-1275	*	12.75	14	124	77	60	45	●
1736SU05C-1280	*	12.8	14	124	77	60	45	●
1736SU05C-1300	*	13	14	124	77	60	45	●
1736SU05C-1310	*	13.1	14	124	77	60	45	●
1736SU05C-1335	*	13.35	14	124	77	60	56	○
1736SU05C-1350	*	13.5	14	124	77	60	45	●
1736SU05C-1380	*	13.8	14	124	77	60	45	●
1736SU05C-1400	*	14	14	124	77	60	45	●
1736SU05C-1420	*	14.2	16	124	77	60	45	●
1736SU05C-1425	*	14.25	16	133	83	63	48	●
1736SU05C-1430	*	14.3	16	133	83	63	48	●
1736SU05C-1450	*	14.5	16	133	83	63	48	●
1736SU05C-1475	*	14.75	16	133	83	63	48	●
1736SU05C-1480	*	14.8	16	133	83	63	48	●
1736SU05C-1500	*	15	16	133	83	63	48	●
1736SU05C-1510	*	15.1	16	133	83	63	48	●
1736SU05C-1535	*	15.35	16	133	83	63	48	○
1736SU05C-1550	*	15.5	16	133	83	63	48	●
1736SU05C-1580	*	15.8	16	133	83	63	48	●
1736SU05C-1600	*	16	16	133	83	63	48	●
1736SU05C-1650	*	16.5	18	143	93	71	48	●
1736SU05C-1675	*	16.75	18	143	93	71	48	●
1736SU05C-1680	*	16.8	18	143	93	71	48	●
1736SU05C-1700	*	17	18	143	93	71	48	●
1736SU05C-1750	*	17.5	18	143	93	71	48	●
1736SU05C-1780	*	17.8	18	143	93	71	48	●
1736SU05C-1800	*	18	18	143	93	71	48	●
1736SU05C-1850	*	18.5	20	153	101	77	50	●
1736SU05C-1880	*	18.8	20	153	101	77	50	●
1736SU05C-1900	*	19	20	153	101	77	50	●
1736SU05C-1950	*	19.5	20	153	101	77	50	●
1736SU05C-1980	*	19.8	20	153	101	77	50	●
1736SU05C-2000	*	20	20	153	101	77	50	●

● Ex stock ○ On demand

All articles SUK on demand

* With internal cooling

Application field						
Type	P	M	K	N	S	H
1736SU*	✓	✓	✓			
1736SUK*			✓			

- ✓ Very suitable
- ✓ Suitable

System code > C44

Machining instructions > C201

Cutting data > C144

Nonstandard order > C150



A

Turning

B

Milling

C

Drilling

D

Technical Information

E

Index

A

SU drill 3xD

General machining

1557SU03



– Type of shank DIN 6535HA



External coolant

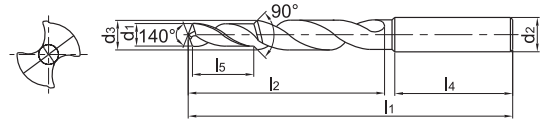

Turning

B

Article	*	Dimensions [mm]							Grade
		d ₁ (m8)	d ₂ (h6)	d ₃ (m7)	l ₁	l ₂	l ₄	l ₅	
1557SU03-M4		3.3	6	4.5	66	28	36	11.4	●
1557SU03-M5		4.2	6	6	66	28	36	13.6	●
1557SU03-M6		5	8	7	79	41	36	16.5	●
1557SU03-M8		6.75	10	9.5	89	47	40	21	●
1557SU03-M8x1.0		7	10	9.8	89	47	40	21	○
1557SU03-M10		8.5	12	12	102	55	45	25.5	●
1557SU03-M10x1.0		9	12	12	102	55	45	25.5	○
1557SU03-M12		10.25	14	14	107	60	45	30	●
1557SU03-M14		12	16	16	115	65	48	34.5	●
1557SU03-M16		14	18	18	123	73	48	38.5	●

● Ex stock ○ On demand

* With internal cooling

Milling

C

Application field						
P	M	K	N	S	H	
✓	✓	✓				✓ Very suitable
						✓ Suitable

Drilling

D

Technical Information

E

Index

System code > C44

Machining instructions > C201

Cutting data > C144

Nonstandard order > C150

SL(K) drill 10xD **General machining** Add K (SLK) to the code for use on Cast Iron

1588SL10C



- Type of shank DIN 6535HA
- Coolant exit, axial concentric



Internal coolant

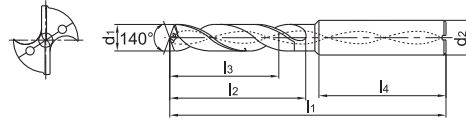

Article	*	Dimensions [mm]						Grade KDG303
		d ₁ (m7)	d ₂ (h6)	l ₁	l ₂	l ₃	l ₄	
1588SL10C-0300	*	3	6	80	43	39	36	●
1588SL10C-0310	*	3.1	6	80	43	39	36	○
1588SL10C-0320	*	3.2	6	80	43	39	36	●
1588SL10C-0330	*	3.3	6	80	43	39	36	●
1588SL10C-0340	*	3.4	6	80	43	39	36	●
1588SL10C-0350	*	3.5	6	80	43	39	36	●
1588SL10C-0360	*	3.6	6	80	43	39	36	●
1588SL10C-0370	*	3.7	6	80	43	39	36	●
1588SL10C-0380	*	3.8	6	80	43	39	36	●
1588SL10C-0390	*	3.9	6	80	43	39	36	●
1588SL10C-0400	*	4	6	92	55	50	36	●
1588SL10C-0410	*	4.1	6	92	55	50	36	●
1588SL10C-0420	*	4.2	6	92	55	50	36	●
1588SL10C-0430	*	4.3	6	92	55	50	36	●
1588SL10C-0440	*	4.4	6	92	55	50	36	●
1588SL10C-0450	*	4.5	6	92	55	50	36	●
1588SL10C-0460	*	4.6	6	92	55	50	36	●
1588SL10C-0470	*	4.7	6	92	55	50	36	●
1588SL10C-0480	*	4.8	6	92	55	50	36	●
1588SL10C-0490	*	4.9	6	92	55	50	36	●
1588SL10C-0500	*	5	6	104	68	61	36	●
1588SL10C-0510	*	5.1	6	104	68	61	36	●
1588SL10C-0520	*	5.2	6	104	68	61	36	●
1588SL10C-0530	*	5.3	6	104	68	61	36	●
1588SL10C-0540	*	5.4	6	104	68	61	36	●
1588SL10C-0550	*	5.5	6	104	68	61	36	●
1588SL10C-0560	*	5.6	6	104	68	61	36	●
1588SL10C-0570	*	5.7	6	104	68	61	36	●
1588SL10C-0580	*	5.8	6	104	68	61	36	●
1588SL10C-0590	*	5.9	6	104	68	61	36	●
1588SL10C-0600	*	6	6	104	68	61	36	●
1588SL10C-0610	*	6.1	8	117	80	71	36	●
1588SL10C-0620	*	6.2	8	117	80	71	36	●
1588SL10C-0630	*	6.3	8	117	80	71	36	●
1588SL10C-0640	*	6.4	8	117	80	71	36	●

● Ex stock ○ On demand

All articles SLK on demand

* With internal cooling

Application field

Type	P	M	K	N	S	H
1588SL*	✓	✓	✓	✓	✓	
1588SLK*			✓			

- ✓ Very suitable
- ✓ Suitable

System code > C44

Machining instructions > C201

Cutting data > C144

Nonstandard order > C150



A

Turning

B

Milling

C

Drilling

D

Technical Information

E

Index

SL(K) drill 10xD

General machining

Add K (SLK) to the code for use on Cast Iron

1588SL10C



- Type of shank DIN 6535HA
- Coolant exit, axial concentric



Internal coolant

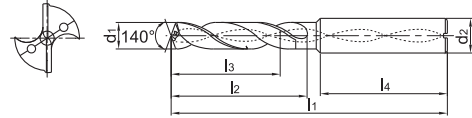

Article	*	Dimensions [mm]						Grade
		d ₁ (m7)	d ₂ (h6)	l ₁	l ₂	l ₃	l ₄	KDG303
1588SL10C-0650	*	6.5	8	117	80	71	36	●
1588SL10C-0660	*	6.6	8	117	80	71	36	●
1588SL10C-0670	*	6.7	8	117	80	71	36	●
1588SL10C-0680	*	6.8	8	117	80	71	36	●
1588SL10C-0690	*	6.9	8	117	80	71	36	●
1588SL10C-0700	*	7	8	117	80	71	36	●
1588SL10C-0710	*	7.1	8	130	94	84	36	●
1588SL10C-0720	*	7.2	8	130	94	84	36	●
1588SL10C-0730	*	7.3	8	130	94	84	36	●
1588SL10C-0740	*	7.4	8	130	94	84	36	●
1588SL10C-0750	*	7.5	8	130	94	84	36	●
1588SL10C-0760	*	7.6	8	130	94	84	36	●
1588SL10C-0770	*	7.7	8	130	94	84	36	●
1588SL10C-0780	*	7.8	8	130	94	84	36	●
1588SL10C-0790	*	7.9	8	130	94	84	36	●
1588SL10C-0800	*	8	8	130	94	84	36	●
1588SL10C-0810	*	8.1	10	148	105	94	40	●
1588SL10C-0820	*	8.2	10	148	105	94	40	●
1588SL10C-0830	*	8.3	10	148	105	94	40	●
1588SL10C-0840	*	8.4	10	148	105	94	40	●
1588SL10C-0850	*	8.5	10	148	105	94	40	●
1588SL10C-0860	*	8.6	10	148	105	94	40	●
1588SL10C-0870	*	8.7	10	148	105	94	40	●
1588SL10C-0880	*	8.8	10	148	105	94	40	●
1588SL10C-0890	*	8.9	10	148	105	94	40	●
1588SL10C-0900	*	9	10	148	105	94	40	●
1588SL10C-0910	*	9.1	10	158	115	103	40	●
1588SL10C-0920	*	9.2	10	158	115	103	40	●
1588SL10C-0930	*	9.3	10	158	115	103	40	●
1588SL10C-0940	*	9.4	10	158	115	103	40	●
1588SL10C-0950	*	9.5	10	158	115	103	40	●
1588SL10C-0960	*	9.6	10	158	115	103	40	●
1588SL10C-0970	*	9.7	10	158	115	103	40	●
1588SL10C-0980	*	9.8	10	158	115	103	40	●
1588SL10C-0990	*	9.9	10	158	115	103	40	●

● Ex stock ○ On demand

All articles SLK on demand

* With internal cooling

Application field

Type	P	M	K	N	S	H
1588SL*	✓	✓	✓	✓	✓	
1588SLK*			✓			

✓ Very suitable

✓ Suitable

System code > C44

Machining instructions > C201

Cutting data > C144

Nonstandard order > C150

SL(K) drill 10xD **General machining** Add K (SLK) to the code for use on Cast Iron

1588SL10C



- Type of shank DIN 6535HA
- Coolant exit, axial concentric



Internal coolant

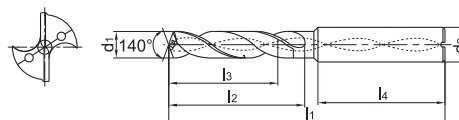

Article	*	Dimensions [mm]						Grade
		d ₁ (m7)	d ₂ (h6)	l ₁	l ₂	l ₃	l ₄	KDG303
1588SL10C-1000	*	10	10	158	115	103	40	●
1588SL10C-1010	*	10.1	12	183	135	121	45	●
1588SL10C-1020	*	10.2	12	183	135	121	45	●
1588SL10C-1030	*	10.3	12	183	135	121	45	●
1588SL10C-1040	*	10.4	12	183	135	121	45	●
1588SL10C-1050	*	10.5	12	183	135	121	45	●
1588SL10C-1060	*	10.6	12	183	135	121	45	●
1588SL10C-1070	*	10.7	12	183	135	121	45	●
1588SL10C-1080	*	10.8	12	183	135	121	45	●
1588SL10C-1090	*	10.9	12	183	135	121	45	●
1588SL10C-1100	*	11	12	183	135	121	45	●
1588SL10C-1110	*	11.1	12	183	135	121	45	●
1588SL10C-1120	*	11.2	12	183	135	121	45	●
1588SL10C-1130	*	11.3	12	183	135	121	45	●
1588SL10C-1140	*	11.4	12	183	135	121	45	●
1588SL10C-1150	*	11.5	12	183	135	121	45	●
1588SL10C-1160	*	11.6	12	183	135	121	45	●
1588SL10C-1170	*	11.7	12	183	135	121	45	●
1588SL10C-1180	*	11.8	12	183	135	121	45	●
1588SL10C-1190	*	11.9	12	183	135	121	45	●
1588SL10C-1200	*	12	12	183	135	121	45	●
1588SL10C-1225	*	12.25	14	209	160	144	45	●
1588SL10C-1250	*	12.5	14	209	160	144	45	●
1588SL10C-1270	*	12.7	14	209	160	144	45	●
1588SL10C-1275	*	12.75	14	209	160	144	45	●
1588SL10C-1280	*	12.8	14	209	160	144	45	●
1588SL10C-1300	*	13	14	209	160	144	45	●
1588SL10C-1310	*	13.1	14	209	160	144	45	●
1588SL10C-1350	*	13.5	14	209	160	144	45	●
1588SL10C-1380	*	13.8	14	209	160	144	45	●
1588SL10C-1400	*	14	14	209	160	144	45	●

● Ex stock ○ On demand

All articles SLK on demand

* With internal cooling

Application field						
Type	P	M	K	N	S	H
1588SL*	✓	✓	✓	✓	✓	
1588SLK*			✓			

- ✓ Very suitable
- ✓ Suitable

System code > C44

Machining instructions > C201

Cutting data > C144

Nonstandard order > C150



SL(K) drill 12xD General machining Add K (SLK) to the code for use on Cast Iron

1588SL12C



- Type of shank DIN 6535HA
- Coolant exit, axial concentric



Internal coolant

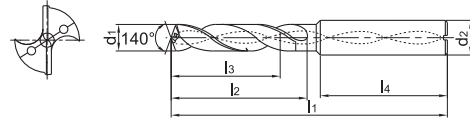

Article	*	Dimensions [mm]						Grade
		d ₁ (m7)	d ₂ (h6)	l ₁	l ₂	l ₃	l ₄	KDG303
1588SL12C-0300	*	3	6	90	50	40	36	●
1588SL12C-0310	*	3.1	6	90	50	40	36	●
1588SL12C-0320	*	3.2	6	90	50	40	36	●
1588SL12C-0330	*	3.3	6	90	50	40	36	●
1588SL12C-0340	*	3.4	6	90	50	40	36	●
1588SL12C-0350	*	3.5	6	90	50	40	36	●
1588SL12C-0360	*	3.6	6	90	50	40	36	●
1588SL12C-0370	*	3.7	6	90	50	46	36	●
1588SL12C-0380	*	3.8	6	90	50	46	36	●
1588SL12C-0390	*	3.9	6	90	50	46	36	●
1588SL12C-0400	*	4	6	102	64	56	36	●
1588SL12C-0410	*	4.1	6	102	64	56	36	●
1588SL12C-0420	*	4.2	6	102	64	56	36	●
1588SL12C-0430	*	4.3	6	102	64	56	36	●
1588SL12C-0440	*	4.4	6	102	64	56	36	●
1588SL12C-0450	*	4.5	6	102	64	56	36	●
1588SL12C-0460	*	4.6	6	102	64	56	36	●
1588SL12C-0470	*	4.7	6	102	64	56	36	●
1588SL12C-0480	*	4.8	6	102	64	56	36	●
1588SL12C-0490	*	4.9	6	102	64	56	36	●
1588SL12C-0500	*	5	6	116	78	72	36	●
1588SL12C-0510	*	5.1	6	116	78	72	36	●
1588SL12C-0520	*	5.2	6	116	78	72	36	●
1588SL12C-0530	*	5.3	6	116	78	72	36	○
1588SL12C-0540	*	5.4	6	116	78	72	36	○
1588SL12C-0550	*	5.5	6	116	78	72	36	●
1588SL12C-0560	*	5.6	6	116	78	72	36	●
1588SL12C-0570	*	5.7	6	116	78	72	36	●
1588SL12C-0580	*	5.8	6	116	78	72	36	●
1588SL12C-0590	*	5.9	6	116	78	72	36	●
1588SL12C-0600	*	6	6	116	78	72	36	●
1588SL12C-0610	*	6.1	8	131	93	84	36	●
1588SL12C-0620	*	6.2	8	131	93	84	36	●
1588SL12C-0630	*	6.3	8	131	93	84	36	●
1588SL12C-0640	*	6.4	8	131	93	84	36	●

● Ex stock ○ On demand

All articles SLK on demand

* With internal cooling

Application field

Type	P	M	K	N	S	H
1588SL*	✓	✓	✓	✓	✓	
1588SLK*			✓			

✓ Very suitable

✓ Suitable

System code > C44

Machining instructions > C201

Cutting data > C144

Nonstandard order > C150

SL(K) drill 12xD **General machining** Add K (SLK) to the code for use on Cast Iron

1588SL12C



- Type of shank DIN 6535HA
- Coolant exit, axial concentric



Internal coolant

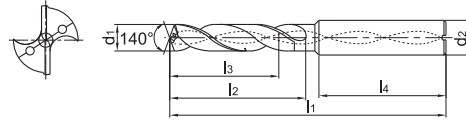

Article	*	Dimensions [mm]						Grade
		d ₁ (m7)	d ₂ (h6)	l ₁	l ₂	l ₃	l ₄	KDG303
1588SL12C-0650	*	6.5	8	131	93	84	36	●
1588SL12C-0660	*	6.6	8	131	93	84	36	●
1588SL12C-0670	*	6.7	8	131	93	84	36	●
1588SL12C-0680	*	6.8	8	131	93	84	36	●
1588SL12C-0690	*	6.9	8	131	93	84	36	●
1588SL12C-0700	*	7	8	131	93	84	36	●
1588SL12C-0710	*	7.1	8	146	108	96	36	●
1588SL12C-0720	*	7.2	8	146	108	96	36	●
1588SL12C-0730	*	7.3	8	146	108	96	36	●
1588SL12C-0740	*	7.4	8	146	108	96	36	●
1588SL12C-0750	*	7.5	8	146	108	96	36	●
1588SL12C-0760	*	7.6	8	146	108	96	36	○
1588SL12C-0770	*	7.7	8	146	108	96	36	○
1588SL12C-0780	*	7.8	8	146	108	96	36	●
1588SL12C-0790	*	7.9	8	146	108	96	36	○
1588SL12C-0800	*	8	8	146	108	96	36	●
1588SL12C-0810	*	8.1	10	162	120	108	40	●
1588SL12C-0820	*	8.2	10	162	120	108	40	●
1588SL12C-0830	*	8.3	10	162	120	108	40	●
1588SL12C-0840	*	8.4	10	162	120	108	40	●
1588SL12C-0850	*	8.5	10	162	120	108	40	●
1588SL12C-0860	*	8.6	10	162	120	108	40	●
1588SL12C-0870	*	8.7	10	162	120	108	40	●
1588SL12C-0880	*	8.8	10	162	120	108	40	●
1588SL12C-0890	*	8.9	10	162	120	108	40	●
1588SL12C-0900	*	9	10	162	120	108	40	●
1588SL12C-0910	*	9.1	10	174	132	120	40	○
1588SL12C-0920	*	9.2	10	174	132	120	40	●
1588SL12C-0930	*	9.3	10	174	132	120	40	●
1588SL12C-0940	*	9.4	10	174	132	120	40	●
1588SL12C-0950	*	9.5	10	174	132	120	40	●
1588SL12C-0960	*	9.6	10	174	132	120	40	○
1588SL12C-0970	*	9.7	10	174	132	120	40	●
1588SL12C-0980	*	9.8	10	174	132	120	40	●
1588SL12C-0990	*	9.9	10	174	132	120	40	○

● Ex stock ○ On demand

All articles SLK on demand

* With internal cooling

Application field

Type	P	M	K	N	S	H
1588SL*	✓	✓	✓	✓	✓	
1588SLK*			✓			

- ✓ Very suitable
- ✓ Suitable

System code > C44

Machining instructions > C201

Cutting data > C144

Nonstandard order > C150



A

Turning

B

Milling

C

Drilling

D

Technical Information

E

Index

SL(K) drill 12xD General machining Add K (SLK) to the code for use on Cast Iron

1588SL12C



- Type of shank DIN 6535HA
- Coolant exit, axial concentric



Internal coolant

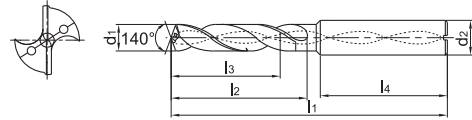

Article	*	Dimensions [mm]						Grade
		d ₁ (m7)	d ₂ (h6)	l ₁	l ₂	l ₃	l ₄	KDG303
1588SL12C-1000	*	10	10	174	132	120	40	●
1588SL12C-1010	*	10.1	12	204	156	144	45	●
1588SL12C-1020	*	10.2	12	204	156	144	45	●
1588SL12C-1030	*	10.3	12	204	156	144	45	●
1588SL12C-1040	*	10.4	12	204	156	144	45	●
1588SL12C-1050	*	10.5	12	204	156	144	45	●
1588SL12C-1060	*	10.6	12	204	156	144	45	●
1588SL12C-1070	*	10.7	12	204	156	144	45	○
1588SL12C-1080	*	10.8	12	204	156	144	45	○
1588SL12C-1090	*	10.9	12	204	156	144	45	○
1588SL12C-1100	*	11	12	204	156	144	45	●
1588SL12C-1110	*	11.1	12	204	156	144	45	●
1588SL12C-1120	*	11.2	12	204	156	144	45	●
1588SL12C-1130	*	11.3	12	204	156	144	45	○
1588SL12C-1140	*	11.4	12	204	156	144	45	○
1588SL12C-1150	*	11.5	12	204	156	144	45	●
1588SL12C-1160	*	11.6	12	204	156	144	45	○
1588SL12C-1170	*	11.7	12	204	156	144	45	●
1588SL12C-1180	*	11.8	12	204	156	144	45	●
1588SL12C-1190	*	11.9	12	204	156	144	45	○
1588SL12C-1200	*	12	12	204	156	144	45	●
1588SL12C-1250	*	12.5	14	230	182	168	45	○
1588SL12C-1270	*	12.7	14	230	182	168	45	○
1588SL12C-1280	*	12.8	14	230	182	168	45	○
1588SL12C-1300	*	13	14	230	182	168	45	○
1588SL12C-1350	*	13.5	14	230	182	168	45	○
1588SL12C-1400	*	14	14	230	182	168	45	○
1588SL12C-1450	*	14.5	16	260	208	194	48	○
1588SL12C-1500	*	15	16	260	208	194	48	○
1588SL12C-1550	*	15.5	16	260	208	194	48	○
1588SL12C-1600	*	16	16	260	208	194	48	○
1588SL12C-1650	*	16.5	18	286	234	218	48	○
1588SL12C-1700	*	17	18	286	234	218	48	○
1588SL12C-1750	*	17.5	18	286	234	218	48	○
1588SL12C-1800	*	18	18	286	234	218	48	○

● Ex stock ○ On demand

All articles SLK on demand

* With internal cooling

Application field

Type	P	M	K	N	S	H
1588SL*	✓	✓	✓	✓	✓	
1588SLK*			✓			

✓ Very suitable

✓ Suitable

System code > C44

Machining instructions > C201

Cutting data > C144

Nonstandard order > C150

SL(K) drill 12xD **General machining** Add K (SLK) to the code for use on Cast Iron

1588SL12C



- Type of shank DIN 6535HA
- Coolant exit, axial concentric



Internal coolant

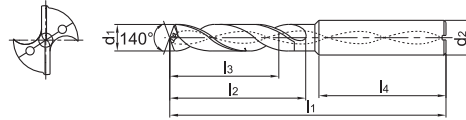

Article	*	Dimensions [mm]						Grade
		d ₁ (m7)	d ₂ (h6)	l ₁	l ₂	l ₃	l ₄	KDG303
1588SL12C-1850	*	18.5	20	310	258	240	48	○
1588SL12C-1900	*	19	20	310	258	240	48	○
1588SL12C-1950	*	19.5	20	310	258	240	48	○
1588SL12C-2000	*	20	20	310	258	240	48	○
1588SL12C-2050	*	20.5	22	310	258	240	48	○
1588SL12C-2100	*	21	22	310	258	240	48	○

● Ex stock ○ On demand

All articles SLK on demand

* With internal cooling

Application field						
Type	P	M	K	N	S	H
1588SL*	✓	✓	✓	✓	✓	
1588SLK*			✓			

- ✓ Very suitable
- ✓ Suitable

A

Turning

B

Milling

C

Drilling

D

Technical Information

E

Index

System code > C44

Machining instructions > C201

Cutting data > C144

Nonstandard order > C150



SL(K) drill 15xD

General machining

Add K (SLK) to the code for use on Cast Iron

1588SL15C



- Type of shank DIN 6535HA
- Coolant exit, axial concentric



Internal coolant

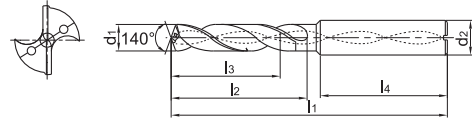

Article	*	Dimensions [mm]						Grade
		d ₁ (m7)	d ₂ (h6)	l ₁	l ₂	l ₃	l ₄	KDG303
1588SL15C-0300	*	3	6	100	60	50	36	●
1588SL15C-0310	*	3.1	6	105	65	55	36	●
1588SL15C-0320	*	3.2	6	105	65	55	36	○
1588SL15C-0330	*	3.3	6	105	65	55	36	●
1588SL15C-0335	*	3.35	6	105	65	55	36	○
1588SL15C-0340	*	3.4	6	105	65	55	36	●
1588SL15C-0350	*	3.5	6	105	65	55	36	●
1588SL15C-0360	*	3.6	6	112	72	62	36	○
1588SL15C-0370	*	3.7	6	112	72	68	36	●
1588SL15C-0380	*	3.8	6	112	72	68	36	●
1588SL15C-0390	*	3.9	6	112	72	68	36	○
1588SL15C-0400	*	4	6	112	72	64	36	●
1588SL15C-0410	*	4.1	6	120	80	72	36	○
1588SL15C-0420	*	4.2	6	120	80	72	36	○
1588SL15C-0430	*	4.3	6	120	80	72	36	○
1588SL15C-0440	*	4.4	6	120	80	72	36	○
1588SL15C-0450	*	4.5	6	120	80	72	36	●
1588SL15C-0460	*	4.6	6	128	88	80	36	●
1588SL15C-0470	*	4.7	6	128	88	80	36	○
1588SL15C-0480	*	4.8	6	128	88	80	36	●
1588SL15C-0490	*	4.9	6	128	88	80	36	●
1588SL15C-0500	*	5	6	128	88	82	36	●
1588SL15C-0510	*	5.1	6	136	96	90	36	●
1588SL15C-0520	*	5.2	6	136	96	90	36	○
1588SL15C-0530	*	5.3	6	136	96	90	36	●
1588SL15C-0540	*	5.4	6	136	96	90	36	○
1588SL15C-0550	*	5.5	6	136	96	90	36	○
1588SL15C-0560	*	5.6	6	144	104	98	36	○
1588SL15C-0570	*	5.7	6	144	104	98	36	○
1588SL15C-0580	*	5.8	6	144	104	98	36	○
1588SL15C-0590	*	5.9	6	144	104	98	36	○
1588SL15C-0600	*	6	6	144	104	98	36	○
1588SL15C-0610	*	6.1	8	152	112	103	36	●
1588SL15C-0620	*	6.2	8	152	112	103	36	●
1588SL15C-0630	*	6.3	8	152	112	103	36	○

● Ex stock ○ On demand

All articles SLK on demand

* With internal cooling

Application field

Type	P	M	K	N	S	H
1588SL*	✓	✓	✓	✓	✓	
1588SLK*			✓			

✓ Very suitable

✓ Suitable

System code > C44

Machining instructions > C201

Cutting data > C144

Nonstandard order > C150

SL(K) drill 15xD **General machining** Add K (SLK) to the code for use on Cast Iron

1588SL15C



- Type of shank DIN 6535HA
- Coolant exit, axial concentric



Internal coolant

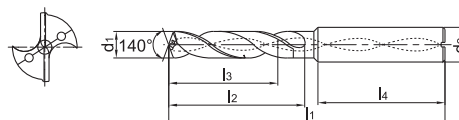

Article	*	Dimensions [mm]						Grade
		d ₁ (m7)	d ₂ (h6)	l ₁	l ₂	l ₃	l ₄	KDG303
1588SL15C-0640	*	6.4	8	152	112	103	36	●
1588SL15C-0650	*	6.5	8	152	112	103	36	●
1588SL15C-0660	*	6.6	8	160	120	111	36	○
1588SL15C-0670	*	6.7	8	160	120	111	36	●
1588SL15C-0680	*	6.8	8	160	120	111	36	○
1588SL15C-0690	*	6.9	8	160	120	111	36	○
1588SL15C-0700	*	7	8	160	120	111	36	●
1588SL15C-0710	*	7.1	8	170	130	118	36	○
1588SL15C-0720	*	7.2	8	170	130	118	36	○
1588SL15C-0730	*	7.3	8	170	130	118	36	○
1588SL15C-0740	*	7.4	8	170	130	118	36	○
1588SL15C-0750	*	7.5	8	170	130	118	36	○
1588SL15C-0760	*	7.6	8	180	140	128	36	○
1588SL15C-0770	*	7.7	8	180	140	128	36	○
1588SL15C-0780	*	7.8	8	180	140	128	36	○
1588SL15C-0790	*	7.9	8	180	140	128	36	○
1588SL15C-0800	*	8	8	180	140	128	36	●
1588SL15C-0810	*	8.1	10	194	150	138	40	○
1588SL15C-0820	*	8.2	10	194	150	138	40	○
1588SL15C-0830	*	8.3	10	194	150	138	40	○
1588SL15C-0840	*	8.4	10	194	150	138	40	○
1588SL15C-0850	*	8.5	10	194	150	138	40	●
1588SL15C-0860	*	8.6	10	204	160	148	40	●
1588SL15C-0870	*	8.7	10	204	160	148	40	○
1588SL15C-0880	*	8.8	10	204	160	148	40	●
1588SL15C-0890	*	8.9	10	204	160	148	40	○
1588SL15C-0900	*	9	10	204	160	148	40	○
1588SL15C-0910	*	9.1	10	216	172	160	40	○
1588SL15C-0920	*	9.2	10	216	172	160	40	○
1588SL15C-0930	*	9.3	10	216	172	160	40	○
1588SL15C-0940	*	9.4	10	216	172	160	40	○
1588SL15C-0950	*	9.5	10	216	172	160	40	○
1588SL15C-0960	*	9.6	10	226	182	170	40	○
1588SL15C-0970	*	9.7	10	226	182	170	40	○
1588SL15C-0980	*	9.8	10	226	182	170	40	○

● Ex stock ○ On demand

All articles SLK on demand

* With internal cooling

Application field

Type	P	M	K	N	S	H
1588SL*	✓	✓	✓	✓	✓	
1588SLK*			✓			

- ✓ Very suitable
- ✓ Suitable

System code > C44

Machining instructions > C201

Cutting data > C144

Nonstandard order > C150



A

Turning

B

Milling

C

Drilling

D

Technical Information

E

Index

SL(K) drill 15xD General machining Add K (SLK) to the code for use on Cast Iron

1588SL15C



- Type of shank DIN 6535HA
- Coolant exit, axial concentric



Internal coolant

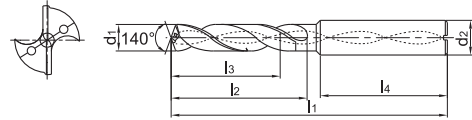

Article	*	Dimensions [mm]						Grade
		d ₁ (m7)	d ₂ (h6)	l ₁	l ₂	l ₃	l ₄	KDG303
1588SL15C-0990	*	9.9	10	226	182	170	40	○
1588SL15C-1000	*	10	10	226	182	170	40	●
1588SL15C-1010	*	10.1	12	240	190	178	45	○
1588SL15C-1020	*	10.2	12	240	190	178	45	○
1588SL15C-1030	*	10.3	12	240	190	178	45	○
1588SL15C-1040	*	10.4	12	240	190	178	45	○
1588SL15C-1050	*	10.5	12	240	190	178	45	○
1588SL15C-1060	*	10.6	12	248	198	186	45	○
1588SL15C-1070	*	10.7	12	248	198	186	45	○
1588SL15C-1080	*	10.8	12	248	198	186	45	○
1588SL15C-1090	*	10.9	12	248	198	186	45	○
1588SL15C-1100	*	11	12	248	198	186	45	●
1588SL15C-1110	*	11.1	12	262	212	200	45	○
1588SL15C-1120	*	11.2	12	262	212	200	45	○
1588SL15C-1130	*	11.3	12	262	212	200	45	○
1588SL15C-1140	*	11.4	12	262	212	200	45	○
1588SL15C-1150	*	11.5	12	262	212	200	45	●
1588SL15C-1160	*	11.6	12	272	222	210	45	○
1588SL15C-1170	*	11.7	12	272	222	210	45	○
1588SL15C-1180	*	11.8	12	272	222	210	45	○
1588SL15C-1190	*	11.9	12	272	222	210	45	○
1588SL15C-1200	*	12	12	272	222	210	45	●

● Ex stock ○ On demand

All articles SLK on demand

* With internal cooling

Application field

Type	P	M	K	N	S	H
1588SL*	✓	✓	✓	✓	✓	
1588SLK*			✓			

✓ Very suitable

✓ Suitable

System code > C44

Machining instructions > C201

Cutting data > C144

Nonstandard order > C150

SL(K) drill 20xD **General machining** Add K (SLK) to the code for use on Cast Iron

1588SL20C



- Type of shank DIN 6535HA
- Coolant exit, axial concentric

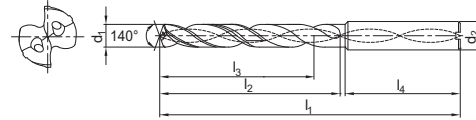

Article	*	Dimensions [mm]						Grade
		d ₁ (m7)	d ₂ (h6)	l ₁	l ₂	l ₃	l ₄	KDG303
1588SL20C-0300	*	3	6	110	70	62	36	●
1588SL20C-0310	*	3.1	6	123	83	72	36	●
1588SL20C-0320	*	3.2	6	123	83	72	36	●
1588SL20C-0330	*	3.3	6	123	83	72	36	●
1588SL20C-0340	*	3.4	6	123	83	72	36	●
1588SL20C-0350	*	3.5	6	123	83	72	36	●
1588SL20C-0360	*	3.6	6	136	96	84	36	●
1588SL20C-0370	*	3.7	6	136	96	84	36	●
1588SL20C-0380	*	3.8	6	136	96	84	36	●
1588SL20C-0390	*	3.9	6	136	96	84	36	●
1588SL20C-0400	*	4	6	136	96	84	36	●
1588SL20C-0410	*	4.1	6	148	108	96	36	●
1588SL20C-0420	*	4.2	6	148	108	96	36	●
1588SL20C-0430	*	4.3	6	148	108	96	36	○
1588SL20C-0440	*	4.4	6	148	108	96	36	○
1588SL20C-0450	*	4.5	6	148	108	96	36	●
1588SL20C-0460	*	4.6	6	158	118	106	36	○
1588SL20C-0470	*	4.7	6	158	118	106	36	○
1588SL20C-0480	*	4.8	6	158	118	106	36	●
1588SL20C-0490	*	4.9	6	158	118	106	36	○
1588SL20C-0500	*	5	6	158	118	106	36	●
1588SL20C-0510	*	5.1	6	168	128	116	36	○
1588SL20C-0520	*	5.2	6	168	128	116	36	●
1588SL20C-0530	*	5.3	6	168	128	116	36	●
1588SL20C-0540	*	5.4	6	168	128	116	36	●
1588SL20C-0550	*	5.5	6	168	128	116	36	●
1588SL20C-0560	*	5.6	6	180	140	126	36	○
1588SL20C-0570	*	5.7	6	180	140	126	36	○
1588SL20C-0580	*	5.8	6	180	140	126	36	●
1588SL20C-0590	*	5.9	6	180	140	126	36	○
1588SL20C-0600	*	6	6	180	140	126	36	●
1588SL20C-0610	*	6.1	8	192	150	132	36	○
1588SL20C-0620	*	6.2	8	192	150	132	36	○
1588SL20C-0630	*	6.3	8	192	150	132	36	●
1588SL20C-0640	*	6.4	8	192	150	132	36	○

● Ex stock ○ On demand

All articles SLK on demand

* With internal cooling

Application field						
Type	P	M	K	N	S	H
1588SL*	✓	✓	✓	✓	✓	
1588SLK*			✓			

- ✓ Very suitable
- ✓ Suitable

System code > C44

Machining instructions > C201

Cutting data > C144

Nonstandard order > C150



A

Turning

B

Milling

C

Drilling

D

Technical Information

E

Index

Solid carbide drills SL/SP series

SL(K) drill 20xD

General machining

Add K (SLK) to the code for use on Cast Iron

1588SL20C



- Type of shank DIN 6535HA
- Coolant exit, axial concentric



Internal coolant

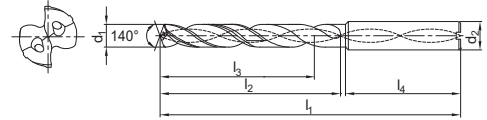

Article	*	Dimensions [mm]						Grade
		d ₁ (m7)	d ₂ (h6)	l ₁	l ₂	l ₃	l ₄	KDG303
1588SL20C-0650	*	6.5	8	192	150	132	36	●
1588SL20C-0660	*	6.6	8	202	162	144	36	○
1588SL20C-0670	*	6.7	8	202	162	144	36	○
1588SL20C-0680	*	6.8	8	202	162	144	36	●
1588SL20C-0690	*	6.9	8	202	162	144	36	○
1588SL20C-0700	*	7	8	202	162	144	36	●
1588SL20C-0710	*	7.1	8	213	173	155	36	○
1588SL20C-0720	*	7.2	8	213	173	155	36	○
1588SL20C-0730	*	7.3	8	213	173	155	36	○
1588SL20C-0740	*	7.4	8	213	173	155	36	○
1588SL20C-0750	*	7.5	8	213	173	155	36	●
1588SL20C-0760	*	7.6	8	223	183	165	36	○
1588SL20C-0770	*	7.7	8	223	183	165	36	○
1588SL20C-0780	*	7.8	8	223	183	165	36	○
1588SL20C-0790	*	7.9	8	223	183	165	36	○
1588SL20C-0800	*	8	8	223	183	165	36	●
1588SL20C-0810	*	8.1	10	239	195	176	40	○
1588SL20C-0820	*	8.2	10	239	195	176	40	○
1588SL20C-0830	*	8.3	10	239	195	176	40	○
1588SL20C-0840	*	8.4	10	239	195	176	40	○
1588SL20C-0850	*	8.5	10	239	195	176	40	●
1588SL20C-0860	*	8.6	10	249	205	186	40	○
1588SL20C-0870	*	8.7	10	249	205	186	40	○
1588SL20C-0880	*	8.8	10	249	205	186	40	○
1588SL20C-0890	*	8.9	10	249	205	186	40	○
1588SL20C-0900	*	9	10	249	205	186	40	○
1588SL20C-0910	*	9.1	10	262	218	196	36	○
1588SL20C-0920	*	9.2	10	262	218	196	36	○
1588SL20C-0930	*	9.3	10	262	218	196	36	○
1588SL20C-0940	*	9.4	10	262	218	196	36	○
1588SL20C-0950	*	9.5	10	262	218	196	36	○
1588SL20C-0960	*	9.6	10	272	228	206	40	○
1588SL20C-0970	*	9.7	10	272	228	206	40	○
1588SL20C-0980	*	9.8	10	272	228	206	40	○
1588SL20C-0990	*	9.9	10	272	228	206	40	○

● Ex stock ○ On demand

All articles SLK on demand

* With internal cooling

Application field

Type	P	M	K	N	S	H
1588SL*	✓	✓	✓	✓	✓	
1588SLK*			✓			

✓ Very suitable

✓ Suitable

System code > C44

Machining instructions > C201

Cutting data > C144

Nonstandard order > C150

SL(K) drill 20xD **General machining** Add K (SLK) to the code for use on Cast Iron

1588SL20C



- Type of shank DIN 6535HA
- Coolant exit, axial concentric



Internal coolant

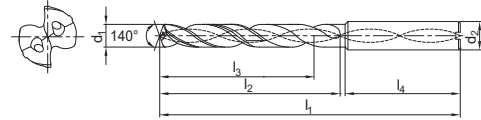

Article	*	Dimensions [mm]						Grade
		d ₁ (m7)	d ₂ (h6)	l ₁	l ₂	l ₃	l ₄	KDG303
1588SL20C-1000	*	10	10	272	228	206	40	●
1588SL20C-1010	*	10.1	12	292	242	220	45	○
1588SL20C-1020	*	10.2	12	292	242	220	45	○
1588SL20C-1030	*	10.3	12	292	242	220	45	○
1588SL20C-1040	*	10.4	12	292	242	220	45	○
1588SL20C-1050	*	10.5	12	292	242	220	45	○
1588SL20C-1060	*	10.6	12	300	250	228	45	○
1588SL20C-1070	*	10.7	12	300	250	228	45	○
1588SL20C-1080	*	10.8	12	300	250	228	45	○
1588SL20C-1090	*	10.9	12	300	250	228	45	○
1588SL20C-1100	*	11	12	300	250	228	45	○
1588SL20C-1110	*	11.1	12	315	265	240	45	○
1588SL20C-1120	*	11.2	12	315	265	240	45	○
1588SL20C-1130	*	11.3	12	315	265	240	45	○
1588SL20C-1140	*	11.4	12	315	265	240	45	○
1588SL20C-1150	*	11.5	12	315	265	240	45	○
1588SL20C-1160	*	11.6	12	325	275	250	45	○
1588SL20C-1170	*	11.7	12	325	275	250	45	○
1588SL20C-1180	*	11.8	12	325	275	250	45	○
1588SL20C-1190	*	11.9	12	325	275	250	45	○
1588SL20C-1200	*	12	12	325	275	250	45	○
1588SL20C-1250	*	12.5	14	325	275	250	45	○
1588SL20C-1300	*	13	14	338	290	265	45	○
1588SL20C-1350	*	13.5	14	338	290	265	45	○
1588SL20C-1400	*	14	14	367	318	290	45	○

● Ex stock ○ On demand

All articles SLK on demand

* With internal cooling

Application field						
Type	P	M	K	N	S	H
1588SL*	✓	✓	✓	✓	✓	
1588SLK*			✓			

✓ Very suitable

✓ Suitable

System code > C44

Machining instructions > C201

Cutting data > C144

Nonstandard order > C150



SL(K) drill 30xD General machining Add K (SLK) to the code for use on Cast Iron

1588SL30C



- Type of shank DIN 6535HA
- Coolant exit, axial concentric



Internal coolant

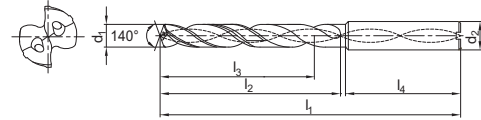

Article	*	Dimensions [mm]						Grade
		d ₁ (m7)	d ₂ (h6)	l ₁	l ₂	l ₃	l ₄	KDG303
1588SL30C-0300	*	3	6	140	100	92	36	●
1588SL30C-0310	*	3.1	6	160	120	108	36	○
1588SL30C-0320	*	3.2	6	160	120	108	36	●
1588SL30C-0330	*	3.3	6	160	120	108	36	○
1588SL30C-0340	*	3.4	6	160	120	108	36	●
1588SL30C-0350	*	3.5	6	160	120	108	36	●
1588SL30C-0360	*	3.6	6	176	136	124	36	○
1588SL30C-0370	*	3.7	6	176	136	124	36	○
1588SL30C-0380	*	3.8	6	176	136	124	36	●
1588SL30C-0390	*	3.9	6	176	136	124	36	●
1588SL30C-0400	*	4	6	176	136	124	36	●
1588SL30C-0410	*	4.1	6	192	152	140	36	○
1588SL30C-0420	*	4.2	6	192	152	140	36	○
1588SL30C-0430	*	4.3	6	192	152	140	36	○
1588SL30C-0440	*	4.4	6	192	152	140	36	○
1588SL30C-0450	*	4.5	6	192	152	140	36	●
1588SL30C-0460	*	4.6	6	208	168	156	36	○
1588SL30C-0470	*	4.7	6	208	168	156	36	○
1588SL30C-0480	*	4.8	6	208	168	156	36	●
1588SL30C-0490	*	4.9	6	208	168	156	36	●
1588SL30C-0500	*	5	6	208	168	156	36	●
1588SL30C-0510	*	5.1	6	228	188	170	36	○
1588SL30C-0520	*	5.2	6	228	188	170	36	●
1588SL30C-0530	*	5.3	6	228	188	170	36	○
1588SL30C-0540	*	5.4	6	228	188	170	36	○
1588SL30C-0550	*	5.5	6	228	188	170	36	●
1588SL30C-0560	*	5.6	6	240	200	182	36	○
1588SL30C-0570	*	5.7	6	240	200	182	36	○
1588SL30C-0580	*	5.8	6	240	200	182	36	●
1588SL30C-0590	*	5.9	6	240	200	182	36	○
1588SL30C-0600	*	6	6	240	200	182	36	●
1588SL30C-0610	*	6.1	8	260	220	202	36	○
1588SL30C-0620	*	6.2	8	260	220	202	36	○
1588SL30C-0630	*	6.3	8	260	220	202	36	●
1588SL30C-0640	*	6.4	8	260	220	202	36	○

● Ex stock ○ On demand

All articles SLK on demand

* With internal cooling

Application field

Type	P	M	K	N	S	H
1588SL*	✓	✓	✓	✓	✓	
1588SLK*			✓			

✓ Very suitable

✓ Suitable

System code > C44

Machining instructions > C201

Cutting data > C144

Nonstandard order > C150

SL(K) drill 30xD **General machining** Add K (SLK) to the code for use on Cast Iron

1588SL30C



- Type of shank DIN 6535HA
- Coolant exit, axial concentric



Internal coolant

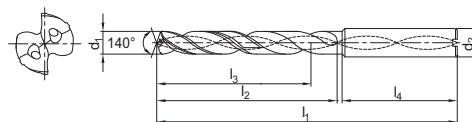

Article	*	Dimensions [mm]						Grade
		d ₁ (m7)	d ₂ (h6)	l ₁	l ₂	l ₃	l ₄	KDG303
1588SL30C-0650	*	6.5	8	260	220	202	36	●
1588SL30C-0660	*	6.6	8	272	232	214	36	○
1588SL30C-0670	*	6.7	8	272	232	214	36	○
1588SL30C-0680	*	6.8	8	272	232	214	36	●
1588SL30C-0690	*	6.9	8	272	232	214	36	○
1588SL30C-0700	*	7	8	272	232	214	36	●
1588SL30C-0710	*	7.1	8	290	250	232	36	○
1588SL30C-0720	*	7.2	8	290	250	232	36	○
1588SL30C-0730	*	7.3	8	290	250	232	36	○
1588SL30C-0740	*	7.4	8	290	250	232	36	○
1588SL30C-0750	*	7.5	8	290	250	232	36	○
1588SL30C-0760	*	7.6	8	305	265	246	36	○
1588SL30C-0770	*	7.7	8	305	265	246	36	○
1588SL30C-0780	*	7.8	8	305	265	246	36	○
1588SL30C-0790	*	7.9	8	305	265	246	36	○
1588SL30C-0800	*	8	8	305	265	246	36	●
1588SL30C-0810	*	8.1	10	330	285	265	40	○
1588SL30C-0820	*	8.2	10	330	285	265	40	○
1588SL30C-0830	*	8.3	10	330	285	265	40	○
1588SL30C-0840	*	8.4	10	330	285	265	40	○
1588SL30C-0850	*	8.5	10	330	285	265	40	●
1588SL30C-0860	*	8.6	10	340	295	275	40	○
1588SL30C-0870	*	8.7	10	340	295	275	40	○
1588SL30C-0880	*	8.8	10	340	295	275	40	○
1588SL30C-0890	*	8.9	10	340	295	275	40	○
1588SL30C-0900	*	9	10	340	295	275	40	○
1588SL30C-0910	*	9.1	10	360	315	292	40	○
1588SL30C-0920	*	9.2	10	360	315	292	40	○
1588SL30C-0930	*	9.3	10	360	315	292	40	○
1588SL30C-0940	*	9.4	10	360	315	292	40	○
1588SL30C-0950	*	9.5	10	360	315	292	40	○
1588SL30C-0960	*	9.6	10	372	328	305	40	○
1588SL30C-0970	*	9.7	10	372	328	305	40	○
1588SL30C-0980	*	9.8	10	372	328	305	40	○
1588SL30C-0990	*	9.9	10	372	328	305	40	○
1588SL30C-1000	*	10	10	372	328	305	40	○

● Ex stock ○ On demand

All articles SLK on demand

* With internal cooling

Application field						
Type	P	M	K	N	S	H
1588SL*	✓	✓	✓	✓	✓	
1588SLK*			✓			

- ✓ Very suitable
- ✓ Suitable

System code > C44

Machining instructions > C201

Cutting data > C144

Nonstandard order > C150



A

Turning

B

Milling

C

Drilling

D

Technical Information

E

Index

SP drill 3xD

General machining

1534SP03C



- Type of shank DIN 6535HA
- Coolant exit, axial concentric



Internal coolant

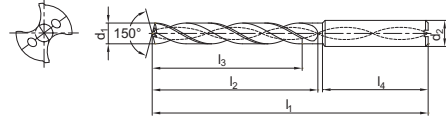

Article	*	Dimensions [mm]						Grade
		d ₁ (h7)	d ₂ (h6)	l ₁	l ₂	l ₃	l ₄	KDG303
1534SP03C-0303	*	3.03	6	62	20	14	36	●
1534SP03C-0313	*	3.13	6	62	20	14	36	○
1534SP03C-0323	*	3.23	6	62	20	14	36	○
1534SP03C-0333	*	3.33	6	62	20	14	36	●
1534SP03C-0343	*	3.43	6	62	20	14	36	●
1534SP03C-0353	*	3.53	6	62	20	14	36	●
1534SP03C-0363	*	3.63	6	62	20	14	36	○
1534SP03C-0373	*	3.73	6	62	20	14	36	○
1534SP03C-0383	*	3.83	6	66	24	17	36	○
1534SP03C-0393	*	3.93	6	66	24	17	36	○
1534SP03C-0403	*	4.03	6	66	24	17	36	●
1534SP03C-0413	*	4.13	6	66	24	17	36	○
1534SP03C-0423	*	4.23	6	66	24	17	36	○
1534SP03C-0433	*	4.33	6	66	24	17	36	○
1534SP03C-0443	*	4.43	6	66	24	17	36	○
1534SP03C-0453	*	4.53	6	66	24	17	36	●
1534SP03C-0463	*	4.63	6	66	24	17	36	○
1534SP03C-0473	*	4.73	6	66	24	17	36	○
1534SP03C-0483	*	4.83	6	66	28	20	36	○
1534SP03C-0493	*	4.93	6	66	28	20	36	○
1534SP03C-0503	*	5.03	6	66	28	20	36	●
1534SP03C-0513	*	5.13	6	66	28	20	36	○
1534SP03C-0523	*	5.23	6	66	28	20	36	○
1534SP03C-0533	*	5.33	6	66	28	20	36	○
1534SP03C-0543	*	5.43	6	66	28	20	36	○
1534SP03C-0553	*	5.53	6	66	28	20	36	●
1534SP03C-0563	*	5.63	6	66	28	20	36	○
1534SP03C-0573	*	5.73	6	66	28	20	36	○
1534SP03C-0583	*	5.83	6	66	28	20	36	○
1534SP03C-0593	*	5.93	6	66	28	20	36	○
1534SP03C-0603	*	6.03	6	66	28	20	36	●
1534SP03C-0613	*	6.13	8	79	34	24	36	○
1534SP03C-0623	*	6.23	8	79	34	24	36	○
1534SP03C-0633	*	6.33	8	79	34	24	36	○
1534SP03C-0643	*	6.43	8	79	34	24	36	○
1534SP03C-0653	*	6.53	8	79	34	24	36	●
1534SP03C-0663	*	6.63	8	79	34	24	36	○

● Ex stock ○ On demand

Pilot drill Ø = Deep drill Ø + 0,03 mm

* With internal cooling

Application field

P	M	K	N	S	H
✓	✓	✓	✓	✓	

✓ Very suitable

✓ Suitable

System code > C44

Machining instructions > C201

Cutting data > C144

Nonstandard order > C150

SP drill 3xD

General machining

1534SP03C



- Type of shank DIN 6535HA
- Coolant exit, axial concentric

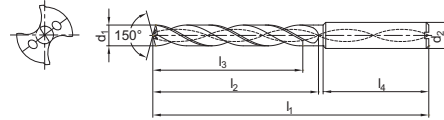
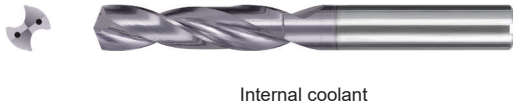

Article	*	Dimensions [mm]						Grade
		d ₁ (h7)	d ₂ (h6)	l ₁	l ₂	l ₃	l ₄	KDG303
1534SP03C-0673	*	6.73	8	79	34	24	36	○
1534SP03C-0683	*	6.83	8	79	34	24	36	○
1534SP03C-0693	*	6.93	8	79	34	24	36	○
1534SP03C-0703	*	7.03	8	79	34	24	36	●
1534SP03C-0713	*	7.13	8	79	41	29	36	○
1534SP03C-0723	*	7.23	8	79	41	29	36	○
1534SP03C-0733	*	7.33	8	79	41	29	36	●
1534SP03C-0743	*	7.43	8	79	41	29	36	○
1534SP03C-0753	*	7.53	8	79	41	29	36	●
1534SP03C-0763	*	7.63	8	79	41	29	36	○
1534SP03C-0773	*	7.73	8	79	41	29	36	○
1534SP03C-0783	*	7.83	8	79	41	29	36	○
1534SP03C-0793	*	7.93	8	79	41	29	36	○
1534SP03C-0803	*	8.03	8	79	41	29	36	●
1534SP03C-0813	*	8.13	10	89	47	35	40	○
1534SP03C-0823	*	8.23	10	89	47	35	40	○
1534SP03C-0833	*	8.33	10	89	47	35	40	●
1534SP03C-0843	*	8.43	10	89	47	35	40	○
1534SP03C-0853	*	8.53	10	89	47	35	40	○
1534SP03C-0863	*	8.63	10	89	47	35	40	○
1534SP03C-0873	*	8.73	10	89	47	35	40	○
1534SP03C-0883	*	8.83	10	89	47	35	40	●
1534SP03C-0893	*	8.93	10	89	47	35	40	○
1534SP03C-0903	*	9.03	10	89	47	35	40	●
1534SP03C-0913	*	9.13	10	89	47	35	40	○
1534SP03C-0923	*	9.23	10	89	47	35	40	○
1534SP03C-0933	*	9.33	10	89	47	35	40	○
1534SP03C-0943	*	9.43	10	89	47	35	40	○
1534SP03C-0953	*	9.53	10	89	47	35	40	●
1534SP03C-0963	*	9.63	10	89	47	35	40	○
1534SP03C-0973	*	9.73	10	89	47	35	40	●
1534SP03C-0983	*	9.83	10	89	47	35	40	●
1534SP03C-0993	*	9.93	10	89	47	35	40	○
1534SP03C-1003	*	10.03	10	89	47	35	40	●
1534SP03C-1013	*	10.13	12	102	55	40	45	○
1534SP03C-1023	*	10.23	12	102	55	40	45	○
1534SP03C-1033	*	10.33	12	102	55	40	45	○

● Ex stock ○ On demand

Pilot drill Ø = Deep drill Ø + 0,03 mm

* With internal cooling

Application field

P	M	K	N	S	H
✓	✓	✓	✓	✓	

✓ Very suitable

✓ Suitable

System code > C44

Machining instructions > C201

Cutting data > C144

Nonstandard order > C150



A

Turning

B

Milling

C

Drilling

D

Technical Information

E

Index

SP drill 3xD

General machining

1534SP03C



- Type of shank DIN 6535HA
- Coolant exit, axial concentric



Internal coolant

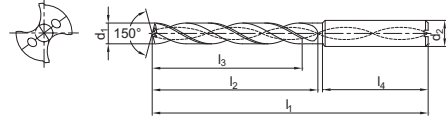

Article	*	Dimensions [mm]						Grade
		d ₁ (h7)	d ₂ (h6)	l ₁	l ₂	l ₃	l ₄	KDG303
1534SP03C-1043	*	10.43	12	102	55	40	45	○
1534SP03C-1053	*	10.53	12	102	55	40	45	●
1534SP03C-1063	*	10.63	12	102	55	40	45	○
1534SP03C-1073	*	10.73	12	102	55	40	45	○
1534SP03C-1083	*	10.83	12	102	55	40	45	●
1534SP03C-1093	*	10.93	12	102	55	40	45	○
1534SP03C-1103	*	11.03	12	102	55	40	45	●
1534SP03C-1113	*	11.13	12	102	55	40	45	○
1534SP03C-1123	*	11.23	12	102	55	40	45	○
1534SP03C-1133	*	11.33	12	102	55	40	45	○
1534SP03C-1143	*	11.43	12	102	55	40	45	○
1534SP03C-1153	*	11.53	12	102	55	40	45	●
1534SP03C-1163	*	11.63	12	102	55	40	45	○
1534SP03C-1173	*	11.73	12	102	55	40	45	○
1534SP03C-1183	*	11.83	12	102	55	40	45	●
1534SP03C-1193	*	11.93	12	102	55	40	45	○
1534SP03C-1203	*	12.03	12	102	55	40	45	●
1534SP03C-1213	*	12.13	14	107	60	43	45	○
1534SP03C-1223	*	12.23	14	107	60	43	45	○
1534SP03C-1233	*	12.33	14	107	60	43	45	○
1534SP03C-1243	*	12.43	14	107	60	43	45	○
1534SP03C-1253	*	12.53	14	107	60	43	45	●
1534SP03C-1263	*	12.63	14	107	60	43	45	○
1534SP03C-1273	*	12.73	14	107	60	43	45	○
1534SP03C-1283	*	12.83	14	107	60	43	45	○
1534SP03C-1293	*	12.93	14	107	60	43	45	○
1534SP03C-1303	*	13.03	14	107	60	43	45	○
1534SP03C-1353	*	13.53	14	107	60	43	45	○
1534SP03C-1403	*	14.03	14	107	60	43	45	○
1534SP03C-1453	*	14.53	16	115	65	45	48	○
1534SP03C-1503	*	15.03	16	115	65	45	48	○
1534SP03C-1553	*	15.53	16	115	65	45	48	○
1534SP03C-1603	*	16.03	16	115	65	45	48	○
1534SP03C-1653	*	16.53	18	123	73	51	48	○
1534SP03C-1703	*	17.03	18	123	73	51	48	○
1534SP03C-1753	*	17.53	18	123	73	51	48	○
1534SP03C-1803	*	18.03	18	123	73	51	48	○

● Ex stock ○ On demand

Pilot drill Ø = Deep drill Ø + 0,03 mm

* With internal cooling

Application field

P	M	K	N	S	H
✓	✓	✓	✓	✓	

✓ Very suitable

✓ Suitable

System code > C44

Machining instructions > C201

Cutting data > C144

Nonstandard order > C150

SP drill 3xD

General machining

1534SP03C



- Type of shank DIN 6535HA
- Coolant exit, axial concentric

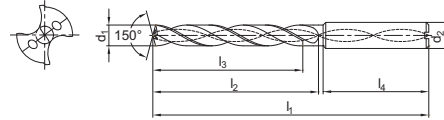
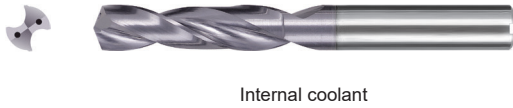

Article	*	Dimensions [mm]						Grade
		d ₁ (h7)	d ₂ (h6)	l ₁	l ₂	l ₃	l ₄	KDG303
1534SP03C-1853	*	18.53	20	131	79	55	50	o
1534SP03C-1903	*	19.03	20	131	79	55	50	o
1534SP03C-1953	*	19.53	20	131	79	55	50	o
1534SP03C-2003	*	20.03	20	131	79	55	50	o

- Ex stock ○ On demand
- Pilot drill Ø = Deep drill Ø + 0,03 mm
- * With internal cooling

Application field					
P	M	K	N	S	H
✓	✓	✓	✓	✓	

- ✓ Very suitable
- ✓ Suitable

A

Turning

B

Milling

C

Drilling

D

Technical Information

E

Index

System code > C44

Machining instructions > C201

Cutting data > C144

Nonstandard order > C150



IMPORTANT INFORMATION

Recommended applications for the **UD series**

Feed calculator

ISO group	Material	Cutting speed v_c (m/min)	Feed factor F_m
M	Stainless steels	80	0,02
S	Ni- / Co-based alloys	40	0,01
S	Titanium alloys	60	0,012

Formula: feed per revolution (F_n) $D \times F_m$
Example: drill diameter (D) 10 mm
 material stainless steel

$F_n = 10 \text{ mm} \times 0,02 = 0,2 \text{ mm/r}$
--



Fig.: 1536UD05C

UD drill 3xD Steel, stainless steel, heat-resistant alloys

1534UD03C



- Type of shank DIN 6535HA
- Coolant exit, axial concentric



External coolant

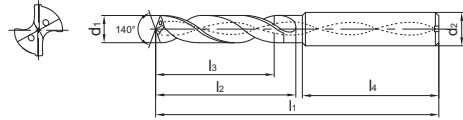

Article	*	Dimensions [mm]						Grade
		d ₁ (m7)	d ₂ (h6)	l ₁	l ₂	l ₃	l ₄	KDG305
1534UD03C-0300	*	3	6	62	20	14	36	●
1534UD03C-0310	*	3.1	6	62	20	14	36	○
1534UD03C-0320	*	3.2	6	62	20	14	36	○
1534UD03C-0330	*	3.3	6	62	20	14	36	●
1534UD03C-0340	*	3.4	6	62	20	14	36	○
1534UD03C-0350	*	3.5	6	62	20	14	36	●
1534UD03C-0360	*	3.6	6	62	20	14	36	○
1534UD03C-0370	*	3.7	6	62	20	14	36	●
1534UD03C-0380	*	3.8	6	66	24	17	36	○
1534UD03C-0390	*	3.9	6	66	24	17	36	○
1534UD03C-0400	*	4	6	66	24	17	36	●
1534UD03C-0410	*	4.1	6	66	24	17	36	○
1534UD03C-0420	*	4.2	6	66	24	17	36	●
1534UD03C-0430	*	4.3	6	66	24	17	36	●
1534UD03C-0440	*	4.4	6	66	24	17	36	○
1534UD03C-0450	*	4.5	6	66	24	17	36	●
1534UD03C-0460	*	4.6	6	66	24	17	36	○
1534UD03C-0465	*	4.65	6	66	24	17	36	●
1534UD03C-0470	*	4.7	6	66	24	17	36	○
1534UD03C-0480	*	4.8	6	66	28	20	36	●
1534UD03C-0490	*	4.9	6	66	28	20	36	○
1534UD03C-0500	*	5	6	66	28	20	36	●
1534UD03C-0510	*	5.1	6	66	28	20	36	○
1534UD03C-0520	*	5.2	6	66	28	20	36	○
1534UD03C-0530	*	5.3	6	66	28	20	36	○
1534UD03C-0540	*	5.4	6	66	28	20	36	○
1534UD03C-0550	*	5.5	6	66	28	20	36	●
1534UD03C-0560	*	5.6	6	66	28	20	36	○
1534UD03C-0570	*	5.7	6	66	28	20	36	●
1534UD03C-0580	*	5.8	6	66	28	20	36	○
1534UD03C-0590	*	5.9	6	66	28	20	36	●
1534UD03C-0600	*	6	6	66	28	20	36	●
1534UD03C-0610	*	6.1	8	79	34	24	36	○
1534UD03C-0620	*	6.2	8	79	34	24	36	○
1534UD03C-0630	*	6.3	8	79	34	24	36	○
1534UD03C-0640	*	6.4	8	79	34	24	36	○
1534UD03C-0650	*	6.5	8	79	34	24	36	●

- Ex stock ○ On demand
- * With internal cooling

Application field

P	M	K	N	S	H
✓	✓			✓	

- ✓ Very suitable
- ✓ Suitable

System code > C44

Machining instructions > C201

Cutting data > C144

Nonstandard order > C150

UD drill 3xD

Steel, stainless steel, heat-resistant alloys

1534UD03C



- Type of shank DIN 6535HA
- Coolant exit, axial concentric



External coolant

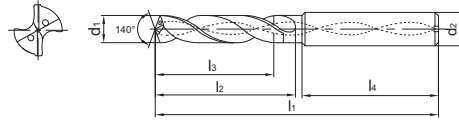

Article	*	Dimensions [mm]						Grade
		d ₁ (m7)	d ₂ (h6)	l ₁	l ₂	l ₃	l ₄	KDG305
1534UD03C-0660	*	6.6	8	79	34	24	36	○
1534UD03C-0670	*	6.7	8	79	34	24	36	○
1534UD03C-0680	*	6.8	8	79	34	24	36	●
1534UD03C-0690	*	6.9	8	79	34	24	36	○
1534UD03C-0700	*	7	8	79	34	24	36	●
1534UD03C-0710	*	7.1	8	79	41	29	36	○
1534UD03C-0720	*	7.2	8	79	41	29	36	○
1534UD03C-0730	*	7.3	8	79	41	29	36	○
1534UD03C-0740	*	7.4	8	79	41	29	36	●
1534UD03C-0750	*	7.5	8	79	41	29	36	●
1534UD03C-0760	*	7.6	8	79	41	29	36	○
1534UD03C-0770	*	7.7	8	79	41	29	36	○
1534UD03C-0780	*	7.8	8	79	41	29	36	○
1534UD03C-0790	*	7.9	8	79	41	29	36	○
1534UD03C-0800	*	8	8	79	41	29	36	●
1534UD03C-0810	*	8.1	10	89	47	35	40	○
1534UD03C-0820	*	8.2	10	89	47	35	40	○
1534UD03C-0830	*	8.3	10	89	47	35	40	○
1534UD03C-0840	*	8.4	10	89	47	35	40	○
1534UD03C-0850	*	8.5	10	89	47	35	40	●
1534UD03C-0860	*	8.6	10	89	47	35	40	○
1534UD03C-0870	*	8.7	10	89	47	35	40	○
1534UD03C-0880	*	8.8	10	89	47	35	40	●
1534UD03C-0890	*	8.9	10	89	47	35	40	○
1534UD03C-0900	*	9	10	89	47	35	40	●
1534UD03C-0910	*	9.1	10	89	47	35	40	○
1534UD03C-0920	*	9.2	10	89	47	35	40	○
1534UD03C-0930	*	9.3	10	89	47	35	40	●
1534UD03C-0940	*	9.4	10	89	47	35	40	○
1534UD03C-0950	*	9.5	10	89	47	35	40	●
1534UD03C-0960	*	9.6	10	89	47	35	40	○
1534UD03C-0970	*	9.7	10	89	47	35	40	○
1534UD03C-0980	*	9.8	10	89	47	35	40	○
1534UD03C-0990	*	9.9	10	89	47	35	40	○
1534UD03C-1000	*	10	10	89	47	35	40	●
1534UD03C-1020	*	10.2	12	102	55	40	45	●
1534UD03C-1050	*	10.5	12	102	55	40	45	●

● Ex stock ○ On demand

* With internal cooling

Application field

P	M	K	N	S	H
✓	✓			✓	

✓ Very suitable

✓ Suitable

System code > C44

Machining instructions > C201

Cutting data > C144

Nonstandard order > C150



UD drill 3xD Steel, stainless steel, heat-resistant alloys

1534UD03C



- Type of shank DIN 6535HA
- Coolant exit, axial concentric



External coolant

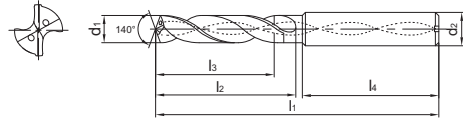

Article	*	Dimensions [mm]						Grade
		d ₁ (m7)	d ₂ (h6)	l ₁	l ₂	l ₃	l ₄	KDG305
1534UD03C-1100	*	11	12	102	55	40	45	●
1534UD03C-1150	*	11.5	12	102	55	40	45	●
1534UD03C-1200	*	12	12	102	55	40	45	●
1534UD03C-1250	*	12.5	14	107	60	43	45	●
1534UD03C-1300	*	13	14	107	60	43	45	●
1534UD03C-1350	*	13.5	14	107	60	43	45	●
1534UD03C-1400	*	14	14	107	60	43	45	●
1534UD03C-1450	*	14.5	16	115	65	45	48	●
1534UD03C-1500	*	15	16	115	65	45	48	●
1534UD03C-1550	*	15.5	16	115	65	45	48	●
1534UD03C-1600	*	16	16	115	65	45	48	●
1534UD03C-1650	*	16.5	18	123	73	51	48	●
1534UD03C-1700	*	17	18	123	73	51	48	●
1534UD03C-1750	*	17.5	18	123	73	51	48	●
1534UD03C-1800	*	18	18	123	73	51	48	●
1534UD03C-1850	*	18.5	20	131	79	55	50	●
1534UD03C-1900	*	19	20	131	79	55	50	●
1534UD03C-1950	*	19.5	20	131	79	55	50	●
1534UD03C-2000	*	20	20	131	79	55	50	●

- Ex stock ○ On demand
- * With internal cooling

Application field

P	M	K	N	S	H
✓	✓			✓	

- ✓ Very suitable
- ✓ Suitable

System code > C44

Machining instructions > C201

Cutting data > C144

Nonstandard order > C150

UD drill 5xD**Steel, stainless steel, heat-resistant alloys****1536UD05C**

- Type of shank DIN 6535HA
- Coolant exit, axial concentric



External coolant

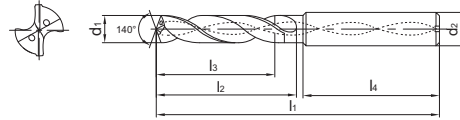

Article	*	Dimensions [mm]						Grade KDG305
		d ₁ (m7)	d ₂ (h6)	l ₁	l ₂	l ₃	l ₄	
1536UD05C-0300	*	3	6	66	28	23	36	●
1536UD05C-0310	*	3.1	6	66	28	23	36	●
1536UD05C-0320	*	3.2	6	66	28	23	36	○
1536UD05C-0330	*	3.3	6	66	28	23	36	●
1536UD05C-0340	*	3.4	6	66	28	23	36	●
1536UD05C-0350	*	3.5	6	66	28	23	36	●
1536UD05C-0360	*	3.6	6	66	28	23	36	○
1536UD05C-0370	*	3.7	6	66	28	23	36	●
1536UD05C-0380	*	3.8	6	74	36	29	36	●
1536UD05C-0390	*	3.9	6	74	36	29	36	○
1536UD05C-0400	*	4	6	74	36	29	36	●
1536UD05C-0410	*	4.1	6	74	36	29	36	○
1536UD05C-0420	*	4.2	6	74	36	29	36	●
1536UD05C-0430	*	4.3	6	74	36	29	36	○
1536UD05C-0440	*	4.4	6	74	36	29	36	○
1536UD05C-0450	*	4.5	6	74	36	29	36	●
1536UD05C-0460	*	4.6	6	74	36	29	36	○
1536UD05C-0465	*	4.65	6	74	36	29	36	●
1536UD05C-0470	*	4.7	6	74	36	29	36	○
1536UD05C-0480	*	4.8	6	82	44	35	36	○
1536UD05C-0490	*	4.9	6	82	44	35	36	○
1536UD05C-0500	*	5	6	82	44	35	36	●
1536UD05C-0510	*	5.1	6	82	44	35	36	●
1536UD05C-0520	*	5.2	6	82	44	35	36	●
1536UD05C-0530	*	5.3	6	82	44	35	36	○
1536UD05C-0540	*	5.4	6	82	44	35	36	○
1536UD05C-0550	*	5.5	6	82	44	35	36	●
1536UD05C-0560	*	5.6	6	82	44	35	36	○
1536UD05C-0570	*	5.7	6	82	44	35	36	○
1536UD05C-0580	*	5.8	6	82	44	35	36	●
1536UD05C-0590	*	5.9	6	82	44	35	36	○
1536UD05C-0600	*	6	6	82	44	35	36	●
1536UD05C-0610	*	6.1	8	91	53	43	36	○
1536UD05C-0620	*	6.2	8	91	53	43	36	○
1536UD05C-0630	*	6.3	8	91	53	43	36	○
1536UD05C-0640	*	6.4	8	91	53	43	36	○
1536UD05C-0650	*	6.5	8	91	53	43	36	●

● Ex stock ○ On demand

* With internal cooling

Application field

P	M	K	N	S	H
✓	✓			✓	

✓ Very suitable

✓ Suitable

System code > C44

Machining instructions > C201

Cutting data > C144

Nonstandard order > C150

UD drill 5xD Steel, stainless steel, heat-resistant alloys

1536UD05C



- Type of shank DIN 6535HA
- Coolant exit, axial concentric



External coolant

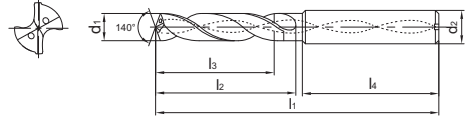

Article	*	Dimensions [mm]						Grade
		d ₁ (m7)	d ₂ (h6)	l ₁	l ₂	l ₃	l ₄	KDG305
1536UD05C-0660	*	6.6	8	91	53	43	36	○
1536UD05C-0670	*	6.7	8	91	53	43	36	●
1536UD05C-0680	*	6.8	8	91	53	43	36	●
1536UD05C-0690	*	6.9	8	91	53	43	36	○
1536UD05C-0700	*	7	8	91	53	43	36	●
1536UD05C-0710	*	7.1	8	91	53	43	36	○
1536UD05C-0720	*	7.2	8	91	53	43	36	○
1536UD05C-0730	*	7.3	8	91	53	43	36	○
1536UD05C-0740	*	7.4	8	91	53	43	36	●
1536UD05C-0750	*	7.5	8	91	53	43	36	●
1536UD05C-0760	*	7.6	8	91	53	43	36	○
1536UD05C-0770	*	7.7	8	91	53	43	36	○
1536UD05C-0780	*	7.8	8	91	53	43	36	○
1536UD05C-0790	*	7.9	8	91	53	43	36	○
1536UD05C-0800	*	8	8	91	53	43	36	●
1536UD05C-0810	*	8.1	10	103	61	49	40	○
1536UD05C-0820	*	8.2	10	103	61	49	40	○
1536UD05C-0830	*	8.3	10	103	61	49	40	●
1536UD05C-0840	*	8.4	10	103	61	49	40	●
1536UD05C-0850	*	8.5	10	103	61	49	40	●
1536UD05C-0860	*	8.6	10	103	61	49	40	○
1536UD05C-0870	*	8.7	10	103	61	49	40	○
1536UD05C-0880	*	8.8	10	103	61	49	40	○
1536UD05C-0890	*	8.9	10	103	61	49	40	○
1536UD05C-0900	*	9	10	103	61	49	40	●
1536UD05C-0910	*	9.1	10	103	61	49	40	○
1536UD05C-0920	*	9.2	10	103	61	49	40	○
1536UD05C-0930	*	9.3	10	103	61	49	40	●
1536UD05C-0940	*	9.4	10	103	61	49	40	○
1536UD05C-0950	*	9.5	10	103	61	49	40	●
1536UD05C-0960	*	9.6	10	103	61	49	40	○
1536UD05C-0970	*	9.7	10	103	61	49	40	○
1536UD05C-0980	*	9.8	10	103	61	49	40	○
1536UD05C-0990	*	9.9	10	103	61	49	40	○
1536UD05C-1000	*	10	10	103	61	49	40	●
1536UD05C-1020	*	10.2	12	118	71	56	45	●
1536UD05C-1050	*	10.5	12	118	71	56	45	●

- Ex stock ○ On demand
- * With internal cooling

Application field

P	M	K	N	S	H
✓	✓			✓	

- ✓ Very suitable
- ✓ Suitable

System code > C44

Machining instructions > C201

Cutting data > C144

Nonstandard order > C150

UD drill 5xD **Steel, stainless steel, heat-resistant alloys**

1536UD05C



- Type of shank DIN 6535HA
- Coolant exit, axial concentric



External coolant

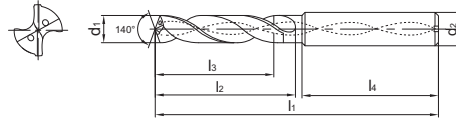

Article	*	Dimensions [mm]						Grade
		d ₁ (m7)	d ₂ (h6)	l ₁	l ₂	l ₃	l ₄	KDG305
1536UD05C-1100	*	11	12	118	71	56	45	●
1536UD05C-1150	*	11.5	12	118	71	56	45	●
1536UD05C-1200	*	12	12	118	71	56	45	●
1536UD05C-1250	*	12.5	14	124	77	60	45	●
1536UD05C-1300	*	13	14	124	77	60	45	●
1536UD05C-1350	*	13.5	14	124	77	60	45	●
1536UD05C-1400	*	14	14	124	77	60	45	●
1536UD05C-1450	*	14.5	16	133	83	63	48	●
1536UD05C-1500	*	15	16	133	83	63	48	●
1536UD05C-1550	*	15.5	16	133	83	63	48	●
1536UD05C-1600	*	16	16	133	83	63	48	●
1536UD05C-1650	*	16.5	18	143	93	71	48	●
1536UD05C-1700	*	17	18	143	93	71	48	●
1536UD05C-1750	*	17.5	18	143	93	71	48	●
1536UD05C-1800	*	18	18	143	93	71	48	●
1536UD05C-1850	*	18.5	20	153	101	77	50	●
1536UD05C-1900	*	19	20	153	101	77	50	●
1536UD05C-1950	*	19.5	20	153	101	77	50	●
1536UD05C-2000	*	20	20	153	101	77	50	●

- Ex stock ○ On demand
- * With internal cooling

Application field					
P	M	K	N	S	H
✓	✓			✓	

- ✓ Very suitable
- ✓ Suitable



A

Turning

B

Milling

C

Drilling

D

Technical Information

E

Index

IMPORTANT INFORMATION

Recommended applications for the **GD series**

Feed calculator

ISO group	Material	Cutting speed v_c (m/min)	Feed factor* F_m
P	Low-alloy steel	130	0,04
	High-alloy steel	100	0,03
K	Cast iron	160	0,04
	Cast steel	130	0,03

Formula: feed per revolution (F_n) $D \times F_m$
Example: drill diameter (D) 10 mm
 material high-alloy steel

$$F_n = 10 \text{ mm} \times 0,03 = 0,3 \text{ mm/rev.}$$

*The stated values are maximum values. For unstable clamping set-ups or low-powered machines, we recommend reducing the feed by around 30% for a drill diameter of $\varnothing 12$ mm or greater.



Fig.: 1536GD05C

Solid carbide drills GD series

GD drill 3xD

Steel, cast iron

1534GD03C



- Type of shank DIN 6535HA
- Coolant exit, axial concentric



External coolant

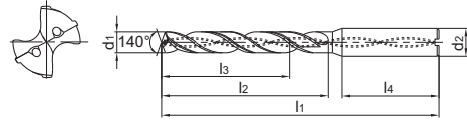

Article	*	Dimensions [mm]						Grade
		d ₁ (m7)	d ₂ (h6)	l ₁	l ₂	l ₃	l ₄	KDG304
1534GD03C-0300	*	3	6	62	20	14	36	●
1534GD03C-0310	*	3.1	6	62	20	14	36	●
1534GD03C-0320	*	3.2	6	62	20	14	36	●
1534GD03C-0330	*	3.3	6	62	20	14	36	●
1534GD03C-0340	*	3.4	6	62	20	14	36	●
1534GD03C-0350	*	3.5	6	62	20	14	36	●
1534GD03C-0360	*	3.6	6	62	20	14	36	●
1534GD03C-0370	*	3.7	6	62	20	14	36	●
1534GD03C-0380	*	3.8	6	66	24	17	36	●
1534GD03C-0390	*	3.9	6	66	24	17	36	●
1534GD03C-0400	*	4	6	66	24	17	36	●
1534GD03C-0410	*	4.1	6	66	24	17	36	●
1534GD03C-0420	*	4.2	6	66	24	17	36	●
1534GD03C-0430	*	4.3	6	66	24	17	36	●
1534GD03C-0440	*	4.4	6	66	24	17	36	●
1534GD03C-0450	*	4.5	6	66	24	17	36	●
1534GD03C-0460	*	4.6	6	66	24	17	36	●
1534GD03C-0465	*	4.65	6	66	24	17	36	●
1534GD03C-0470	*	4.7	6	66	24	17	36	●
1534GD03C-0480	*	4.8	6	66	28	20	36	●
1534GD03C-0490	*	4.9	6	66	28	20	36	●
1534GD03C-0500	*	5	6	66	28	20	36	●
1534GD03C-0510	*	5.1	6	66	28	20	36	●
1534GD03C-0520	*	5.2	6	66	28	20	36	●
1534GD03C-0530	*	5.3	6	66	28	20	36	●
1534GD03C-0540	*	5.4	6	66	28	20	36	●
1534GD03C-0550	*	5.5	6	66	28	20	36	●
1534GD03C-0560	*	5.6	6	66	28	20	36	●
1534GD03C-0570	*	5.7	6	66	28	20	36	●
1534GD03C-0580	*	5.8	6	66	28	20	36	●
1534GD03C-0590	*	5.9	6	66	28	20	36	●
1534GD03C-0600	*	6	6	66	28	20	36	●
1534GD03C-0610	*	6.1	8	79	34	24	36	●
1534GD03C-0620	*	6.2	8	79	34	24	36	●
1534GD03C-0630	*	6.3	8	79	34	24	36	●
1534GD03C-0640	*	6.4	8	79	34	24	36	●
1534GD03C-0650	*	6.5	8	79	34	24	36	●

- Ex stock ○ On demand
- * With internal cooling

Application field

P	M	K	N	S	H
✓		✓			

- ✓ Very suitable
- ✓ Suitable

System code > C44

Machining instructions > C201

Cutting data > C144

Nonstandard order > C150

GD drill 3xD

Steel, cast iron

1534GD03C



- Type of shank DIN 6535HA
- Coolant exit, axial concentric



External coolant

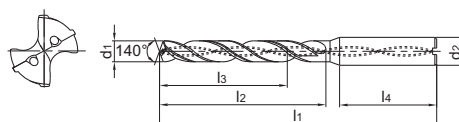

Article	*	Dimensions [mm]						Grade
		d ₁ (m7)	d ₂ (h6)	l ₁	l ₂	l ₃	l ₄	KDG304
1534GD03C-0660	*	6.6	8	79	34	24	36	●
1534GD03C-0670	*	6.7	8	79	34	24	36	●
1534GD03C-0680	*	6.8	8	79	34	24	36	●
1534GD03C-0690	*	6.9	8	79	34	24	36	●
1534GD03C-0700	*	7	8	79	34	24	36	●
1534GD03C-0710	*	7.1	8	79	41	29	36	●
1534GD03C-0720	*	7.2	8	79	41	29	36	●
1534GD03C-0730	*	7.3	8	79	41	29	36	●
1534GD03C-0740	*	7.4	8	79	41	29	36	●
1534GD03C-0750	*	7.5	8	79	41	29	36	●
1534GD03C-0760	*	7.6	8	79	41	29	36	●
1534GD03C-0770	*	7.7	8	79	41	29	36	●
1534GD03C-0780	*	7.8	8	79	41	29	36	●
1534GD03C-0790	*	7.9	8	79	41	29	36	●
1534GD03C-0800	*	8	8	79	41	29	36	●
1534GD03C-0810	*	8.1	10	89	47	35	40	●
1534GD03C-0820	*	8.2	10	89	47	35	40	●
1534GD03C-0830	*	8.3	10	89	47	35	40	●
1534GD03C-0840	*	8.4	10	89	47	35	40	●
1534GD03C-0850	*	8.5	10	89	47	35	40	●
1534GD03C-0860	*	8.6	10	89	47	35	40	●
1534GD03C-0870	*	8.7	10	89	47	35	40	●
1534GD03C-0880	*	8.8	10	89	47	35	40	●
1534GD03C-0890	*	8.9	10	89	47	35	40	●
1534GD03C-0900	*	9	10	89	47	35	40	●
1534GD03C-0910	*	9.1	10	89	47	35	40	●
1534GD03C-0920	*	9.2	10	89	47	35	40	●
1534GD03C-0930	*	9.3	10	89	47	35	40	●
1534GD03C-0940	*	9.4	10	89	47	35	40	●
1534GD03C-0950	*	9.5	10	89	47	35	40	●
1534GD03C-0960	*	9.6	10	89	47	35	40	●
1534GD03C-0970	*	9.7	10	89	47	35	40	●
1534GD03C-0980	*	9.8	10	89	47	35	40	●
1534GD03C-0990	*	9.9	10	89	47	35	40	●
1534GD03C-1000	*	10	10	89	47	35	40	●
1534GD03C-1020	*	10.2	12	102	55	40	45	●
1534GD03C-1050	*	10.5	12	102	55	40	45	●

● Ex stock ○ On demand

* With internal cooling

Application field

P	M	K	N	S	H
✓		✓			

✓ Very suitable

✓ Suitable

System code > C44

Machining instructions > C201

Cutting data > C144

Nonstandard order > C150



A

Turning

B

Milling

C

Drilling

D

Technical Information

E

Index

Solid carbide drills GD series

GD drill 3xD

Steel, cast iron

1534GD03C



- Type of shank DIN 6535HA
- Coolant exit, axial concentric



External coolant

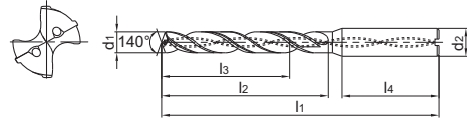

Article	*	Dimensions [mm]						Grade
		d ₁ (m7)	d ₂ (h6)	l ₁	l ₂	l ₃	l ₄	KDG304
1534GD03C-1100	*	11	12	102	55	40	45	●
1534GD03C-1140	*	11.4	12	102	55	40	45	●
1534GD03C-1150	*	11.5	12	102	55	40	45	●
1534GD03C-1200	*	12	12	102	55	40	45	●
1534GD03C-1250	*	12.5	14	107	60	43	45	●
1534GD03C-1300	*	13	14	107	60	43	45	●
1534GD03C-1350	*	13.5	14	107	60	43	45	●
1534GD03C-1400	*	14	14	107	60	43	45	●
1534GD03C-1450	*	14.5	16	115	65	45	48	●
1534GD03C-1500	*	15	16	115	65	45	48	●
1534GD03C-1550	*	15.5	16	115	65	45	48	●
1534GD03C-1600	*	16	16	115	65	45	48	●
1534GD03C-1650	*	16.5	18	123	73	51	48	●
1534GD03C-1700	*	17	18	123	73	51	48	●
1534GD03C-1750	*	17.5	18	123	73	51	48	●
1534GD03C-1800	*	18	18	123	73	51	48	●
1534GD03C-1850	*	18.5	20	131	79	55	50	●
1534GD03C-1900	*	19	20	131	79	55	50	●
1534GD03C-1950	*	19.5	20	131	79	55	50	●
1534GD03C-2000	*	20	20	131	79	55	50	●

● Ex stock ○ On demand

* With internal cooling

Application field

P	M	K	N	S	H
✓		✓			

✓ Very suitable

✓ Suitable

System code > C44

Machining instructions > C201

Cutting data > C144

Nonstandard order > C150

GD drill 5xD

Steel, cast iron

1536GD05C



- Type of shank DIN 6535HA
- Coolant exit, axial concentric



External coolant

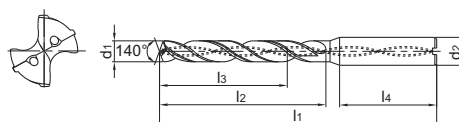

Article	*	Dimensions [mm]						Grade
		d ₁ (m7)	d ₂ (h6)	l ₁	l ₂	l ₃	l ₄	KDG304
1536GD05C-0300	*	3	6	66	28	23	36	●
1536GD05C-0310	*	3.1	6	66	28	23	36	●
1536GD05C-0320	*	3.2	6	66	28	23	36	●
1536GD05C-0330	*	3.3	6	66	28	23	36	●
1536GD05C-0340	*	3.4	6	66	28	23	36	●
1536GD05C-0350	*	3.5	6	66	28	23	36	●
1536GD05C-0360	*	3.6	6	66	28	23	36	●
1536GD05C-0370	*	3.7	6	66	28	23	36	●
1536GD05C-0380	*	3.8	6	74	36	29	36	●
1536GD05C-0390	*	3.9	6	74	36	29	36	●
1536GD05C-0400	*	4	6	74	36	29	36	●
1536GD05C-0410	*	4.1	6	74	36	29	36	●
1536GD05C-0420	*	4.2	6	74	36	29	36	●
1536GD05C-0430	*	4.3	6	74	36	29	36	●
1536GD05C-0440	*	4.4	6	74	36	29	36	●
1536GD05C-0450	*	4.5	6	74	36	29	36	●
1536GD05C-0460	*	4.6	6	74	36	29	36	●
1536GD05C-0465	*	4.65	6	74	36	29	36	●
1536GD05C-0470	*	4.7	6	74	36	29	36	●
1536GD05C-0480	*	4.8	6	82	44	35	36	●
1536GD05C-0490	*	4.9	6	82	44	35	36	●
1536GD05C-0500	*	5	6	82	44	35	36	●
1536GD05C-0508	*	5.08	6	82	44	35	36	○
1536GD05C-0510	*	5.1	6	82	44	35	36	●
1536GD05C-0520	*	5.2	6	82	44	35	36	●
1536GD05C-0530	*	5.3	6	82	44	35	36	●
1536GD05C-0540	*	5.4	6	82	44	35	36	●
1536GD05C-0550	*	5.5	6	82	44	35	36	●
1536GD05C-0560	*	5.6	6	82	44	35	36	●
1536GD05C-0570	*	5.7	6	82	44	35	36	●
1536GD05C-0580	*	5.8	6	82	44	35	36	●
1536GD05C-0590	*	5.9	6	82	44	35	36	●
1536GD05C-0600	*	6	6	82	44	35	36	●
1536GD05C-0610	*	6.1	8	91	53	43	36	●
1536GD05C-0620	*	6.2	8	91	53	43	36	●
1536GD05C-0630	*	6.3	8	91	53	43	36	●
1536GD05C-0640	*	6.4	8	91	53	43	36	●

● Ex stock ○ On demand

* With internal cooling

Application field

P	M	K	N	S	H
✓		✓			

✓ Very suitable

✓ Suitable

System code > C44

Machining instructions > C201

Cutting data > C144

Nonstandard order > C150



A

Turning

B

Milling

C

Drilling

D

Technical Information

E

Index

Solid carbide drills GD series

GD drill 5xD

Steel, cast iron

1536GD05C



- Type of shank DIN 6535HA
- Coolant exit, axial concentric



External coolant

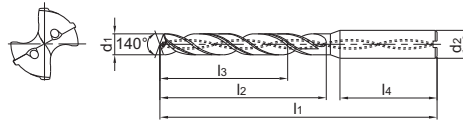

Article	*	Dimensions [mm]						Grade
		d ₁ (m7)	d ₂ (h6)	l ₁	l ₂	l ₃	l ₄	KDG304
1536GD05C-0650	*	6.5	8	91	53	43	36	●
1536GD05C-0660	*	6.6	8	91	53	43	36	●
1536GD05C-0670	*	6.7	8	91	53	43	36	●
1536GD05C-0680	*	6.8	8	91	53	43	36	●
1536GD05C-0690	*	6.9	8	91	53	43	36	●
1536GD05C-0700	*	7	8	91	53	43	36	●
1536GD05C-0710	*	7.1	8	91	53	43	36	●
1536GD05C-0720	*	7.2	8	91	53	43	36	●
1536GD05C-0730	*	7.3	8	91	53	43	36	●
1536GD05C-0740	*	7.4	8	91	53	43	36	●
1536GD05C-0750	*	7.5	8	91	53	43	36	●
1536GD05C-0760	*	7.6	8	91	53	43	36	●
1536GD05C-0770	*	7.7	8	91	53	43	36	●
1536GD05C-0780	*	7.8	8	91	53	43	36	●
1536GD05C-0790	*	7.9	8	91	53	43	36	●
1536GD05C-0800	*	8	8	91	53	43	36	●
1536GD05C-0810	*	8.1	10	103	61	49	40	●
1536GD05C-0820	*	8.2	10	103	61	49	40	●
1536GD05C-0830	*	8.3	10	103	61	49	40	●
1536GD05C-0840	*	8.4	10	103	61	49	40	●
1536GD05C-0850	*	8.5	10	103	61	49	40	●
1536GD05C-0860	*	8.6	10	103	61	49	40	●
1536GD05C-0870	*	8.7	10	103	61	49	40	●
1536GD05C-0880	*	8.8	10	103	61	49	40	●
1536GD05C-0890	*	8.9	10	103	61	49	40	●
1536GD05C-0900	*	9	10	103	61	49	40	●
1536GD05C-0910	*	9.1	10	103	61	49	40	●
1536GD05C-0920	*	9.2	10	103	61	49	40	●
1536GD05C-0930	*	9.3	10	103	61	49	40	●
1536GD05C-0940	*	9.4	10	103	61	49	40	●
1536GD05C-0950	*	9.5	10	103	61	49	40	●
1536GD05C-0960	*	9.6	10	103	61	49	40	●
1536GD05C-0970	*	9.7	10	103	61	49	40	●
1536GD05C-0980	*	9.8	10	103	61	49	40	●
1536GD05C-0990	*	9.9	10	103	61	49	40	●
1536GD05C-1000	*	10	10	103	61	49	40	●
1536GD05C-1010	*	10.1	12	118	71	56	45	●

● Ex stock ○ On demand

* With internal cooling

Application field

P	M	K	N	S	H
✓		✓			

✓ Very suitable

✓ Suitable

System code > C44

Machining instructions > C201

Cutting data > C144

Nonstandard order > C150

GD drill 5xD

Steel, cast iron

1536GD05C



- Type of shank DIN 6535HA
- Coolant exit, axial concentric



External coolant

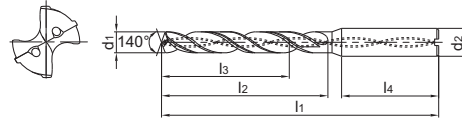

Article	*	Dimensions [mm]						Grade
		d ₁ (m7)	d ₂ (h6)	l ₁	l ₂	l ₃	l ₄	
1536GD05C-1020	*	10.2	12	118	71	56	45	●
1536GD05C-1030	*	10.3	12	118	71	56	45	●
1536GD05C-1040	*	10.4	12	118	71	56	45	●
1536GD05C-1050	*	10.5	12	118	71	56	45	●
1536GD05C-1060	*	10.6	12	118	71	56	45	●
1536GD05C-1070	*	10.7	12	118	71	56	45	●
1536GD05C-1080	*	10.8	12	118	71	56	45	●
1536GD05C-1090	*	10.9	12	118	71	56	45	●
1536GD05C-1100	*	11	12	118	71	56	45	●
1536GD05C-1130	*	11.3	12	118	71	56	45	●
1536GD05C-1140	*	11.4	12	118	71	56	45	●
1536GD05C-1150	*	11.5	12	118	71	56	45	●
1536GD05C-1200	*	12	12	118	71	56	45	●
1536GD05C-1250	*	12.5	14	124	77	60	45	●
1536GD05C-1280	*	12.8	14	124	77	60	45	●
1536GD05C-1300	*	13	14	124	77	60	45	●
1536GD05C-1350	*	13.5	14	124	77	60	45	●
1536GD05C-1380	*	13.8	14	124	77	60	45	○
1536GD05C-1400	*	14	14	124	77	60	45	●
1536GD05C-1450	*	14.5	16	133	83	63	48	●
1536GD05C-1500	*	15	16	133	83	63	48	●
1536GD05C-1510	*	15.1	16	133	83	63	48	○
1536GD05C-1550	*	15.5	16	133	83	63	48	●
1536GD05C-1600	*	16	16	133	83	63	48	●
1536GD05C-1650	*	16.5	18	143	93	71	48	●
1536GD05C-1700	*	17	18	143	93	71	48	●
1536GD05C-1750	*	17.5	18	143	93	71	48	●
1536GD05C-1800	*	18	18	143	93	71	48	●
1536GD05C-1850	*	18.5	20	153	101	77	50	●
1536GD05C-1900	*	19	20	153	101	77	50	●
1536GD05C-1950	*	19.5	20	153	101	77	50	●
1536GD05C-2000	*	20	20	153	101	77	50	●

● Ex stock ○ On demand

* With internal cooling

Application field					
P	M	K	N	S	H
✓		✓			

✓ Very suitable

✓ Suitable

System code > C44

Machining instructions > C201

Cutting data > C144

Nonstandard order > C150



A

Turning

B

Milling

C

Drilling

D

Technical Information

E

Index

Solid carbide drills GD series

GD drill 5xD

Steel, cast iron

1636GD05C



- Type of shank DIN 6535HB
- Coolant exit, axial concentric



External coolant

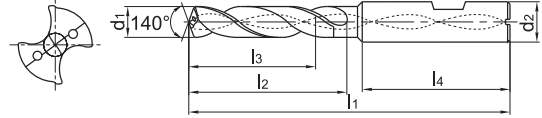

Article	*	Dimensions [mm]						Grade
		d ₁ (m7)	d ₂ (h6)	l ₁	l ₂	l ₃	l ₄	KDG304
1636GD05C-0500	*	5	6	82	44	35	36	●
1636GD05C-0550	*	5.5	6	82	44	35	36	●
1636GD05C-0600	*	6	6	82	44	35	36	●
1636GD05C-0650	*	6.5	8	91	53	43	36	●
1636GD05C-0680	*	6.8	8	91	53	43	36	●
1636GD05C-0700	*	7	8	91	53	43	36	●
1636GD05C-0740	*	7.4	8	91	53	43	36	●
1636GD05C-0750	*	7.5	8	91	53	43	36	●
1636GD05C-0780	*	7.8	8	91	53	43	36	●
1636GD05C-0800	*	8	8	91	53	43	36	●
1636GD05C-0850	*	8.5	10	103	61	49	40	●
1636GD05C-0880	*	8.8	10	103	61	49	40	●
1636GD05C-0900	*	9	10	103	61	49	40	●
1636GD05C-0930	*	9.3	10	103	61	49	40	●
1636GD05C-0950	*	9.5	10	103	61	49	40	●
1636GD05C-0980	*	9.8	10	103	61	49	40	●
1636GD05C-1000	*	10	10	103	61	49	40	●
1636GD05C-1020	*	10.2	12	118	71	56	45	●
1636GD05C-1050	*	10.5	12	118	71	56	45	●
1636GD05C-1080	*	10.8	12	118	71	56	45	●
1636GD05C-1100	*	11	12	118	71	56	45	●
1636GD05C-1150	*	11.5	12	118	71	56	45	●
1636GD05C-1180	*	11.8	12	118	71	56	45	●
1636GD05C-1200	*	12	12	118	71	56	45	●
1636GD05C-1250	*	12.5	14	124	77	60	45	●
1636GD05C-1280	*	12.8	14	124	77	60	45	○
1636GD05C-1300	*	13	14	124	77	60	45	●
1636GD05C-1350	*	13.5	14	124	77	60	45	●
1636GD05C-1380	*	13.8	14	124	77	60	45	●
1636GD05C-1400	*	14	14	124	77	60	45	●
1636GD05C-1450	*	14.5	16	133	83	63	48	●
1636GD05C-1480	*	14.8	16	133	83	63	48	●
1636GD05C-1500	*	15	16	133	83	63	48	●
1636GD05C-1550	*	15.5	16	133	83	63	48	●
1636GD05C-1580	*	15.8	16	133	83	63	48	●
1636GD05C-1600	*	16	16	133	83	63	48	●
1636GD05C-1650	*	16.5	18	143	93	71	48	●

● Ex stock ○ On demand

* With internal cooling

Application field

P	M	K	N	S	H
✓		✓			

✓ Very suitable

✓ Suitable

System code > C44

Machining instructions > C201

Cutting data > C144

Nonstandard order > C150

GD drill 5xD

Steel, cast iron

1636GD05C



- Type of shank DIN 6535HB
- Coolant exit, axial concentric



External coolant

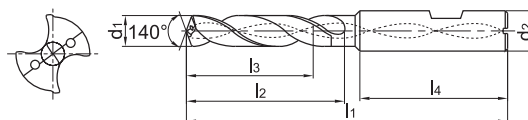

Article	*	Dimensions [mm]						Grade
		d ₁ (m7)	d ₂ (h6)	l ₁	l ₂	l ₃	l ₄	KDG304
1636GD05C-1680	*	16.8	18	143	93	71	48	○
1636GD05C-1700	*	17	18	143	93	71	48	●
1636GD05C-1750	*	17.5	18	143	93	71	48	●
1636GD05C-1780	*	17.8	18	143	93	71	48	●
1636GD05C-1800	*	18	18	143	93	71	48	●
1636GD05C-1850	*	18.5	20	153	101	77	50	●
1636GD05C-1880	*	18.8	20	153	101	77	50	○
1636GD05C-1900	*	19	20	153	101	77	50	●
1636GD05C-1950	*	19.5	20	153	101	77	50	●
1636GD05C-1980	*	19.8	20	153	101	77	50	●
1636GD05C-2000	*	20	20	153	101	77	50	●

- Ex stock ○ On demand
- * With internal cooling

Application field					
P	M	K	N	S	H
✓		✓			

- ✓ Very suitable
- ✓ Suitable

System code > C44

Machining instructions > C201

Cutting data > C144

Nonstandard order > C150



A

Turning

B

Milling

C

Drilling

D

Technical Information

E

Index

SH drill 3xD

Hard materials

1534SH03



- Type of shank DIN 6535HA



External coolant

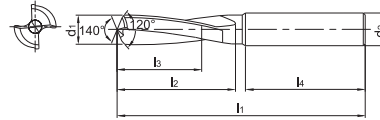

Article	*	Dimensions [mm]						Grade
		d ₁ (m7)	d ₂ (h6)	l ₁	l ₂	l ₃	l ₄	KDG303
1534SH03-0300		3	6	62	20	14	36	○
1534SH03-0330		3.3	6	62	20	14	36	●
1534SH03-0400		4	6	66	24	17	36	○
1534SH03-0420		4.2	6	66	24	17	36	●
1534SH03-0500		5	6	66	28	20	36	○
1534SH03-0600		6	6	66	28	20	36	○
1534SH03-0675		6.75	8	79	34	24	36	○
1534SH03-0700		7	8	79	34	24	36	○
1534SH03-0800		8	8	79	41	29	36	○
1534SH03-0850		8.5	10	89	47	35	40	○
1534SH03-0900		9	10	89	47	35	40	○
1534SH03-1000		10	10	89	47	35	40	○
1534SH03-1025		10.25	12	102	55	40	45	○
1534SH03-1050		10.5	12	102	55	40	45	○
1534SH03-1200		12	12	102	55	40	45	○
1534SH03-1250		12.5	14	107	60	43	45	○
1534SH03-1400		14	14	107	60	43	45	○
1534SH03-1450		14.5	16	115	65	45	48	○
1534SH03-1600		16	16	115	65	45	48	○
1534SH03-2000		20	20	131	79	53	50	○

● Ex stock ○ On demand

* With internal cooling

Application field					
P	M	K	N	S	H
					✓

✓ Very suitable

✓ Suitable

System code > C44

Machining instructions > C201

Cutting data > C144

Nonstandard order > C150



A

Turning

B

Milling

C

Drilling

D

Technical Information

E

Index

SC drill 3xD

Non-ferrous metals

1105SC03



- Factory standard



External coolant

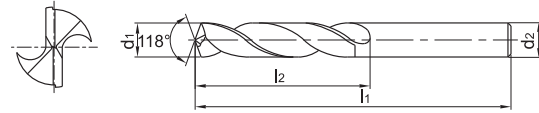

Article	*	Dimensions [mm]				Grade
		d ₁ (h8)	d ₂ (h7)	l ₁	l ₂	YK20F
1105SC03-0200		2	2	38	12	o
1105SC03-0250		2.5	2.5	43	14	o
1105SC03-0280		2.8	2.8	46	16	o
1105SC03-0300		3	3	46	16	o
1105SC03-0310		3.1	3.1	49	18	o
1105SC03-0320		3.2	3.2	49	18	o
1105SC03-0330		3.3	3.3	49	18	o
1105SC03-0340		3.4	3.4	52	20	o
1105SC03-0350		3.5	3.5	52	20	o
1105SC03-0360		3.6	3.6	52	20	o
1105SC03-0370		3.7	3.7	52	20	o
1105SC03-0380		3.8	3.8	55	22	o
1105SC03-0390		3.9	3.9	55	22	o
1105SC03-0400		4	4	55	22	o
1105SC03-0410		4.1	4.1	55	22	o
1105SC03-0420		4.2	4.2	55	22	o
1105SC03-0430		4.3	4.3	58	24	o
1105SC03-0440		4.4	4.4	58	24	o
1105SC03-0450		4.5	4.5	58	24	o
1105SC03-0460		4.6	4.6	58	24	o
1105SC03-0470		4.7	4.7	58	24	o
1105SC03-0480		4.8	4.8	62	26	o
1105SC03-0490		4.9	4.9	62	26	o
1105SC03-0500		5	5	62	26	o
1105SC03-0510		5.1	5.1	62	26	o
1105SC03-0520		5.2	5.2	62	26	o
1105SC03-0530		5.3	5.3	62	26	o
1105SC03-0540		5.4	5.4	66	28	o
1105SC03-0550		5.5	5.5	66	28	o
1105SC03-0560		5.6	5.6	66	28	o
1105SC03-0570		5.7	5.7	66	28	o
1105SC03-0580		5.8	5.8	66	28	o
1105SC03-0590		5.9	5.9	66	28	o
1105SC03-0600		6	6	66	28	o
1105SC03-0610		6.1	6.1	70	31	o
1105SC03-0620		6.2	6.2	70	31	o
1105SC03-0630		6.3	6.3	70	31	o
1105SC03-0640		6.4	6.4	70	31	o

● Ex stock ○ On demand

* With internal cooling

Application field					
P	M	K	N	S	H
			✓		

✓ Very suitable
✓ Suitable

System code > C44

Machining instructions > C201

Cutting data > C144

Nonstandard order > C150



A

Turning

B

Milling

C

Drilling

D

Technical Information

E

Index

SC drill 3xD

Non-ferrous metals

1105SC03



– Factory standard



External coolant

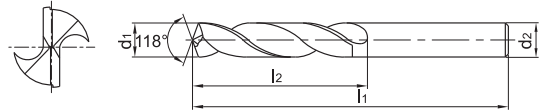

Article	*	Dimensions [mm]				Grade
		d ₁ (h8)	d ₂ (h7)	l ₁	l ₂	YK20F
1105SC03-0650		6.5	6.5	70	31	○
1105SC03-0660		6.6	6.6	70	31	○
1105SC03-0670		6.7	6.7	70	31	○
1105SC03-0680		6.8	6.8	74	34	○
1105SC03-0690		6.9	6.9	74	34	○
1105SC03-0700		7	7	74	34	○
1105SC03-0710		7.1	7.1	74	34	○
1105SC03-0720		7.2	7.2	74	34	○
1105SC03-0730		7.3	7.3	74	34	○
1105SC03-0740		7.4	7.4	74	34	○
1105SC03-0750		7.5	7.5	74	34	○
1105SC03-0760		7.6	7.6	79	37	○
1105SC03-0770		7.7	7.7	79	37	○
1105SC03-0780		7.8	7.8	79	37	○
1105SC03-0790		7.9	7.9	79	37	○
1105SC03-0800		8	8	79	37	○
1105SC03-0810		8.1	8.1	79	37	○
1105SC03-0820		8.2	8.2	79	37	○
1105SC03-0830		8.3	8.3	79	37	○
1105SC03-0840		8.4	8.4	79	37	○
1105SC03-0850		8.5	8.5	79	37	○
1105SC03-0860		8.6	8.6	84	40	○
1105SC03-0870		8.7	8.7	84	40	○
1105SC03-0880		8.8	8.8	84	40	○
1105SC03-0890		8.9	8.9	84	40	○
1105SC03-0900		9	9	84	40	○
1105SC03-0910		9.1	9.1	84	40	○
1105SC03-0920		9.2	9.2	84	40	○
1105SC03-0930		9.3	9.3	84	40	○
1105SC03-0940		9.4	9.4	84	40	○
1105SC03-0950		9.5	9.5	84	40	○
1105SC03-0960		9.6	9.6	89	43	○
1105SC03-0970		9.7	9.7	89	43	○
1105SC03-0980		9.8	9.8	89	43	○
1105SC03-0990		9.9	9.9	89	43	○
1105SC03-1000		10	10	89	43	○
1105SC03-1010		10.1	10.1	89	43	○
1105SC03-1020		10.2	10.2	89	43	○

● Ex stock ○ On demand

* With internal cooling

Application field

P	M	K	N	S	H
			✓		

✓ Very suitable

✓ Suitable

System code > C44

Machining instructions > C201

Cutting data > C144

Nonstandard order > C150

SC drill 3xD

Non-ferrous metals

1105SC03



- Factory standard



External coolant

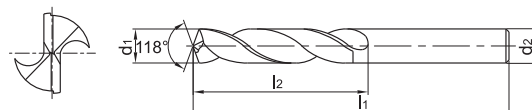

Article	*	Dimensions [mm]				Grade
		d ₁ (h8)	d ₂ (h7)	l ₁	l ₂	YK20F
1105SC03-1040		10.4	10.4	89	43	○
1105SC03-1050		10.5	10.5	89	43	○
1105SC03-1070		10.7	10.7	95	47	○
1105SC03-1080		10.8	10.8	95	47	○
1105SC03-1100		11	11	95	47	○
1105SC03-1150		11.5	11.5	95	47	○
1105SC03-1200		12	12	102	51	○
1105SC03-1250		12.5	12.5	102	51	○
1105SC03-1280		12.8	12.8	102	51	○
1105SC03-1300		13	13	102	51	○
1105SC03-1310		13.1	13.1	102	51	○
1105SC03-1350		13.5	13.5	107	54	○
1105SC03-1400		14	14	107	54	○
1105SC03-1430		14.3	14.3	111	56	○
1105SC03-1450		14.5	14.5	111	56	○
1105SC03-1500		15	15	111	56	○
1105SC03-1600		16	16	115	58	○

● Ex stock ○ On demand

* With internal cooling

Application field

P	M	K	N	S	H
			✓		

✓ Very suitable

✓ Suitable

System code > C44

Machining instructions > C201

Cutting data > C144

Nonstandard order > C150



SC drill 5xD

Non-ferrous metals

1101SC05



– Factory standard



External coolant

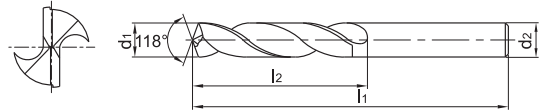

Article	*	Dimensions [mm]				Grade
		d ₁ (h8)	d ₂ (h7)	l ₁	l ₂	YK20F
1101SC05-0200		2	2	49	24	○
1101SC05-0250		2.5	2.5	57	30	○
1101SC05-0280		2.8	2.8	61	33	○
1101SC05-0300		3	3	61	33	○
1101SC05-0350		3.5	3.5	70	39	○
1101SC05-0380		3.8	3.8	75	43	○
1101SC05-0400		4	4	75	43	○
1101SC05-0420		4.2	4.2	75	43	○
1101SC05-0450		4.5	4.5	80	47	○
1101SC05-0480		4.8	4.8	86	52	○
1101SC05-0500		5	5	86	52	○
1101SC05-0550		5.5	5.5	93	57	○
1101SC05-0580		5.8	5.8	93	57	○
1101SC05-0600		6	6	93	57	○
1101SC05-0650		6.5	6.5	101	63	○
1101SC05-0680		6.8	6.8	109	69	○
1101SC05-0700		7	7	109	69	○
1101SC05-0750		7.5	7.5	109	69	○
1101SC05-0780		7.8	7.8	117	75	○
1101SC05-0800		8	8	117	75	○
1101SC05-0850		8.5	8.5	117	75	○
1101SC05-0880		8.8	8.8	125	81	○
1101SC05-0900		9	9	125	81	○
1101SC05-0950		9.5	9.5	125	81	○
1101SC05-0980		9.8	9.8	133	87	○
1101SC05-1000		10	10	133	87	○
1101SC05-1050		10.5	10.5	133	87	○
1101SC05-1080		10.8	10.8	142	94	○
1101SC05-1100		11	11	142	94	○
1101SC05-1150		11.5	11.5	142	94	○
1101SC05-1200		12	12	151	101	○
1101SC05-1250		12.5	12.5	151	101	○
1101SC05-1300		13	13	151	101	○
1101SC05-1350		13.5	13.5	160	108	○
1101SC05-1400		14	14	160	108	○
1101SC05-1450		14.5	14.5	169	114	○
1101SC05-1500		15	15	169	114	○
1101SC05-1550		15.5	15.5	178	120	○
1101SC05-1600		16	16	178	120	○

● Ex stock ○ On demand

* With internal cooling

Application field

P	M	K	N	S	H
			✓		

✓ Very suitable

✓ Suitable

System code > C44

Machining instructions > C201

Cutting data > C144

Nonstandard order > C150

PA drill 3xD

Non-ferrous metals

1165PA03



- Factory standard



External coolant

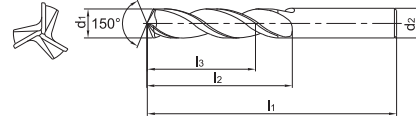

Article	*	Dimensions [mm]					Grade	
		d ₁ (h7)	d ₂ (h7)	l ₁	l ₂	l ₃	KDG303	YK30F
1165PA03-0300		3	3	46	16	12	●	●
1165PA03-0310		3.1	3.1	49	18	14	○	○
1165PA03-0320		3.2	3.2	49	18	14	○	●
1165PA03-0330		3.3	3.3	49	18	14	○	○
1165PA03-0340		3.4	3.4	52	20	15	○	●
1165PA03-0350		3.5	3.5	52	20	15	○	○
1165PA03-0360		3.6	3.6	52	20	15	○	○
1165PA03-0370		3.7	3.7	52	20	15	○	○
1165PA03-0380		3.8	3.8	55	22	17	○	○
1165PA03-0390		3.9	3.9	55	22	17	○	○
1165PA03-0400		4	4	55	22	17	○	○
1165PA03-0410		4.1	4.1	55	22	17	○	○
1165PA03-0420		4.2	4.2	55	22	17	○	○
1165PA03-0430		4.3	4.3	58	24	18	○	○
1165PA03-0440		4.4	4.4	58	24	18	○	○
1165PA03-0450		4.5	4.5	58	24	18	○	○
1165PA03-0460		4.6	4.6	58	24	18	○	○
1165PA03-0470		4.7	4.7	58	24	18	○	○
1165PA03-0480		4.8	4.8	62	26	20	○	○
1165PA03-0490		4.9	4.9	62	26	20	○	○
1165PA03-0500		5	5	62	26	20	○	○
1165PA03-0510		5.1	5.1	62	26	20	○	○
1165PA03-0520		5.2	5.2	62	26	20	○	○
1165PA03-0530		5.3	5.3	62	26	20	○	○
1165PA03-0540		5.4	5.4	66	28	21	○	○
1165PA03-0550		5.5	5.5	66	28	21	○	○
1165PA03-0560		5.6	5.6	66	28	21	○	○
1165PA03-0570		5.7	5.7	66	28	21	○	○
1165PA03-0580		5.8	5.8	66	28	21	○	○
1165PA03-0590		5.9	5.9	66	28	21	○	○
1165PA03-0600		6	6	66	28	21	○	○
1165PA03-0610		6.1	6.1	70	31	23	○	○
1165PA03-0620		6.2	6.2	70	31	23	○	○
1165PA03-0630		6.3	6.3	70	31	23	○	○
1165PA03-0640		6.4	6.4	70	31	23	○	○
1165PA03-0650		6.5	6.5	70	31	23	○	○
1165PA03-0660		6.6	6.6	70	31	23	○	●
1165PA03-0670		6.7	6.7	70	31	23	○	●

● Ex stock ○ On demand

* With internal cooling

Application field					
P	M	K	N	S	H
			✓		

✓ Very suitable
✓ Suitable

System code > C44

Machining instructions > C201

Cutting data > C144

Nonstandard order > C150



A

Turning

B

Milling

C

Drilling

D

Technical Information

E

Index

PA drill 3xD

Non-ferrous metals

1165PA03



– Factory standard



External coolant

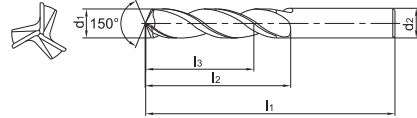

Article	*	Dimensions [mm]					Grade	
		d ₁ (h7)	d ₂ (h7)	l ₁	l ₂	l ₃	KDG303	YK30F
1165PA03-0680		6.8	6.8	74	34	25	○	○
1165PA03-0690		6.9	6.9	74	34	25	○	○
1165PA03-0700		7	7	74	34	25	○	○
1165PA03-0710		7.1	7.1	74	34	25	○	○
1165PA03-0720		7.2	7.2	74	34	25	○	○
1165PA03-0730		7.3	7.3	74	34	25	○	○
1165PA03-0740		7.4	7.4	74	34	25	○	○
1165PA03-0750		7.5	7.5	74	34	25	○	○
1165PA03-0760		7.6	7.6	79	37	27	○	○
1165PA03-0770		7.7	7.7	79	37	27	○	○
1165PA03-0780		7.8	7.8	79	37	27	○	○
1165PA03-0790		7.9	7.9	79	37	27	○	○
1165PA03-0800		8	8	79	37	27	○	○
1165PA03-0810		8.1	8.1	79	37	27	○	○
1165PA03-0820		8.2	8.2	79	37	27	○	○
1165PA03-0830		8.3	8.3	79	37	27	○	○
1165PA03-0840		8.4	8.4	79	37	27	○	○
1165PA03-0850		8.5	8.5	79	37	27	○	○
1165PA03-0860		8.6	8.6	84	40	29	○	●
1165PA03-0870		8.7	8.7	84	40	29	○	○
1165PA03-0880		8.8	8.8	84	40	29	○	○
1165PA03-0890		8.9	8.9	84	40	29	○	○
1165PA03-0900		9	9	84	40	29	○	○
1165PA03-0910		9.1	9.1	84	40	29	○	○
1165PA03-0920		9.2	9.2	84	40	29	○	○
1165PA03-0930		9.3	9.3	84	40	29	○	○
1165PA03-0940		9.4	9.4	84	40	29	○	○
1165PA03-0950		9.5	9.5	84	40	29	○	○
1165PA03-0960		9.6	9.6	89	43	31	○	○
1165PA03-0970		9.7	9.7	89	43	31	○	○
1165PA03-0980		9.8	9.8	89	43	31	○	○
1165PA03-0990		9.9	9.9	89	43	31	○	○
1165PA03-1000		10	10	89	43	31	○	○
1165PA03-1010		10.1	10.1	89	43	31	○	○
1165PA03-1020		10.2	10.2	89	43	31	○	○
1165PA03-1030		10.3	10.3	89	43	31	○	○
1165PA03-1050		10.5	10.5	89	43	31	○	○
1165PA03-1100		11	11	95	47	33	○	○

● Ex stock ○ On demand

* With internal cooling

Application field

P	M	K	N	S	H
			✓		

✓ Very suitable

✓ Suitable

System code > C44

Machining instructions > C201

Cutting data > C144

Nonstandard order > C150

PA drill 3xD

Non-ferrous metals

1165PA03



– Factory standard



External coolant

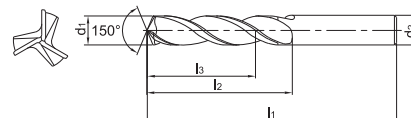

Article	*	Dimensions [mm]					Grade	
		d ₁ (h7)	d ₂ (h7)	l ₁	l ₂	l ₃	KDG303	YK30F
1165PA03-1120		11.2	11.2	95	47	33	○	○
1165PA03-1150		11.5	11.5	95	47	33	○	○
1165PA03-1180		11.8	11.8	95	47	33	○	○
1165PA03-1200		12	12	102	51	35	○	○
1165PA03-1210		12.1	12.1	102	51	35	○	○
1165PA03-1250		12.5	12.5	102	51	35	○	○
1165PA03-1300		13	13	102	51	35	○	○
1165PA03-1350		13.5	13.5	107	54	37	○	○
1165PA03-1400		14	14	107	54	37	○	○
1165PA03-1450		14.5	14.5	111	56	38	○	○
1165PA03-1500		15	15	111	56	38	○	○
1165PA03-1550		15.5	15.5	115	58	38	○	○
1165PA03-1600		16	16	115	58	38	○	○
1165PA03-1650		16.5	16.5	119	60	39	○	○
1165PA03-1700		17	17	119	60	39	○	○
1165PA03-1750		17.5	17.5	123	62	40	○	○
1165PA03-1800		18	18	123	62	40	○	○
1165PA03-1850		18.5	18.5	127	64	41	○	○
1165PA03-1900		19	19	127	64	41	○	○
1165PA03-1950		19.5	19.5	131	66	42	○	○
1165PA03-2000		20	20	131	66	42	○	○

● Ex stock ○ On demand

* With internal cooling

Application field					
P	M	K	N	S	H
			✓		

✓ Very suitable
✓ Suitable

System code > C44

Machining instructions > C201

Cutting data > C144

Nonstandard order > C150



PC drill 5xD

Cast iron

1576PC05/1576PC05C



- Type of shank DIN 6535HA
- Coolant exit, axial concentric

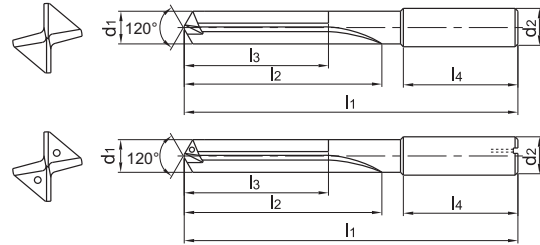
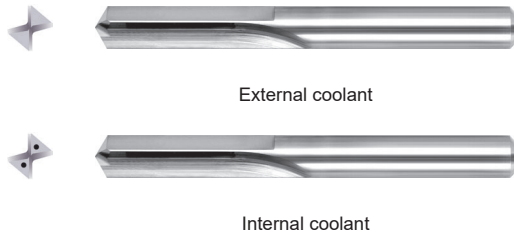

Article	*	Dimensions [mm]						Grade	
		d ₁ (m7)	d ₂ (h6)	l ₁	l ₂	l ₃	l ₄	YK20F	
1576PC05-0400		4	6	74	36	29	36		○
1576PC05C-0400	*	4	6	74	36	29	36		●
1576PC05-0420		4.2	6	74	36	29	36		○
1576PC05C-0420	*	4.2	6	74	36	29	36		●
1576PC05-0500		5	6	82	44	35	36		○
1576PC05C-0500	*	5	6	82	44	35	36		●
1576PC05-0600		6	6	82	44	35	36		○
1576PC05C-0600	*	6	6	82	44	35	36		●
1576PC05-0675		6.75	8	91	53	43	36		○
1576PC05C-0675	*	6.75	8	91	53	43	36		●
1576PC05-0700		7	8	91	53	43	36		○
1576PC05C-0700	*	7	8	91	53	43	36		●
1576PC05-0800		8	8	91	53	43	36		○
1576PC05C-0800	*	8	8	91	53	43	36		●
1576PC05-0850		8.5	10	103	61	49	40		○
1576PC05C-0850	*	8.5	10	103	61	49	40		●
1576PC05-0900		9	10	103	61	49	40		○
1576PC05C-0900	*	9	10	103	61	49	40		●
1576PC05-1000		10	10	103	61	49	40		○
1576PC05C-1000	*	10	10	103	61	49	40		●
1576PC05-1025		10.25	12	118	71	56	45		○
1576PC05C-1025	*	10.25	12	118	71	56	45		●
1576PC05-1100		11	12	118	71	56	45		○
1576PC05C-1100	*	11	12	118	71	56	45		●
1576PC05-1200		12	12	118	71	56	45		○
1576PC05C-1200	*	12	12	118	71	56	45		●
1576PC05-1300		13	14	124	77	60	45		○
1576PC05C-1300	*	13	14	124	77	60	45		●
1576PC05-1400		14	14	124	77	60	45		○
1576PC05C-1400	*	14	14	124	77	60	45		●
1576PC05-1500		15	16	133	83	63	48		○
1576PC05C-1500	*	15	16	133	83	63	48		●
1576PC05-1550		15.5	16	133	83	63	48		○

- Ex stock ○ On demand
- * With internal cooling

Application field					
P	M	K	N	S	H
		✓			

- ✓ Very suitable
- ✓ Suitable

System code > C44 Machining instructions > C201 Cutting data > C144 Nonstandard order > C150



A

Turning

B

Milling

C

Drilling

D

Technical Information

E

Index

PC drill 5xD

Cast iron

1576PC05/1576PC05C



- Type of shank DIN 6535HA
- Coolant exit, axial concentric

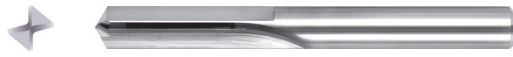

External coolant



Internal coolant

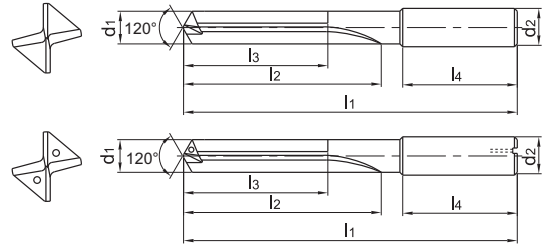

Article	*	Dimensions [mm]						Grade
		d ₁ (m7)	d ₂ (h6)	l ₁	l ₂	l ₃	l ₄	YK20F
1576PC05C-1550	*	15.5	16	133	83	63	48	○
1576PC05-1600		16	16	133	83	63	48	○
1576PC05C-1600	*	16	16	133	83	63	48	○
1576PC05-1700		17	18	143	93	71	48	○
1576PC05C-1700	*	17	18	143	93	71	48	○
1576PC05-1750		17.5	18	143	93	71	48	○
1576PC05C-1750	*	17.5	18	143	93	71	48	○
1576PC05-1800		18	18	143	93	71	48	○
1576PC05C-1800	*	18	18	143	93	71	48	●
1576PC05-1950		19.5	20	153	101	77	50	○
1576PC05C-1950	*	19.5	20	153	101	77	50	○
1576PC05-2000		20	20	153	101	77	50	○
1576PC05C-2000	*	20	20	153	101	77	50	○

● Ex stock ○ On demand

* With internal cooling

Application field

P	M	K	N	S	H
		✓			

✓ Very suitable

✓ Suitable

System code > C44

Machining instructions > C201

Cutting data > C144

Nonstandard order > C150

PC drill 15xD

Cast iron

1579PC15C



- Type of shank DIN 6535HA
- Coolant exit, axial concentric



Internal coolant

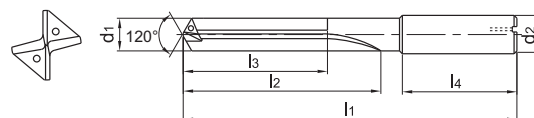

Article	*	Dimensions [mm]						Grade
		d ₁ (m7)	d ₂ (h6)	l ₁	l ₂	l ₃	l ₄	YK20F
1579PC15C-0500	*	5	6	145	105	96	36	○
1579PC15C-0600	*	6	6	145	105	96	36	○
1579PC15C-0800	*	8	8	180	137	127	36	○
1579PC15C-0900	*	9	10	217	170	158	40	○
1579PC15C-1000	*	10	10	217	170	158	40	○
1579PC15C-1100	*	11	12	258	205	190	45	○
1579PC15C-1200	*	12	12	258	205	190	45	○
1579PC15C-1400	*	14	14	290	236	219	45	○

● Ex stock ○ On demand

* With internal cooling

Application field					
P	M	K	N	S	H
		✓			

✓ Very suitable

✓ Suitable

System code > C44

Machining instructions > C201

Cutting data > C144

Nonstandard order > C150



A

Turning

B

Milling

C

Drilling

D

Technical Information

E

Index

SC drill – NC tapping device 90°

General machining

1143SC90



– Factory standard



External coolant

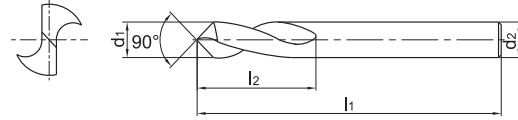

Article	*	Dimensions [mm]				Grade	
		d ₁ (h6)	d ₂ (h6)	l ₁	l ₂	KDG303	YK30F
1143SC90-0500		5	5	62	10	●	
1143SC90-0600		6	6	66	15	●	
1143SC90-0800		8	8	79	17	●	
1143SC90-1000		10	10	89	20	●	
1143SC90-1200		12	12	102	25	●	
1143SC90-1400		14	14	107	30	●	
1143SC90-1600		16	16	115	35	●	
1143SC90-2000		20	20	131	40	●	○

● Ex stock ○ On demand

* With internal cooling

Application field

P	M	K	N	S	H
✓	✓	✓	✓		

✓ Very suitable

✓ Suitable

A

Turning

B

Milling

C

Drilling

D

Technical Information

E

Index

System code > C44

Machining instructions > C201

Cutting data > C144

Nonstandard order > C150



A

SC drill – NC tapping device 120°

General machining

Turning

1143SC120



– Factory standard



External coolant

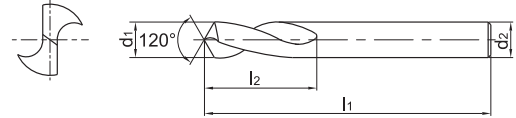

B

Milling

Article	*	Dimensions [mm]				Grade
		d ₁ (h6)	d ₂ (h6)	l ₁	l ₂	KDG303
1143SC120-0400		4	4	62	10	○
1143SC120-0500		5	5	62	10	●
1143SC120-0600		6	6	66	15	●
1143SC120-0800		8	8	79	17	●
1143SC120-1000		10	10	89	20	●
1143SC120-1200		12	12	102	25	●
1143SC120-1400		14	14	107	30	●
1143SC120-1600		16	16	115	35	●
1143SC120-2000		20	20	131	42	●

● Ex stock ○ On demand

* With internal cooling

C

Drilling

Application field					
P	M	K	N	S	H
✓	✓	✓	✓		

✓ Very suitable

✓ Suitable

D

Technical Information

E

Index

System code > C44

Machining instructions > C201

Cutting data > C144

Nonstandard order > C150

SC drill – NC tapping device 142°

General machining

1143SC142



– Factory standard



External coolant

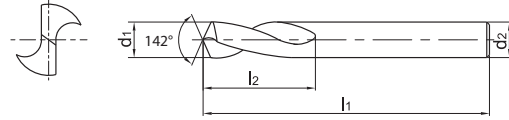

Article	*	Dimensions [mm]				Grade
		d ₁ (h6)	d ₂ (h6)	l ₁	l ₂	KDG303
1143SC142-0500		5	5	62	10	●
1143SC142-0600		6	6	66	15	●
1143SC142-0800		8	8	79	17	●
1143SC142-1000		10	10	89	20	●
1143SC142-1200		12	12	102	25	●
1143SC142-1400		14	14	107	30	●
1143SC142-1600		16	16	115	35	●
1143SC142-2000		20	20	131	42	●

● Ex stock ○ On demand

* With internal cooling

Application field

P	M	K	N	S	H
✓	✓	✓	✓		

✓ Very suitable

✓ Suitable

A

Turning

B

Milling

C

Drilling

D

Technical Information

E

Index

System code > C44

Machining instructions > C201

Cutting data > C144

Nonstandard order > C150



Guide for recommended cutting data – solid carbide drilling

Solid carbide drills

Material group	Composition / structure / heat treatment	Brinell hardness HB	Machining group	Starting values for cutting speed v_c [m/min]										
				SU Series			SU-Drill			SU Step Drill				
				3-5xD	8xD	3xD	KDG 303	KDG 303	KDG 303	Coolant				
				internal	external	f-group	internal	external	f-group	internal	external	f-group		
P Unalloyed steel	ca. 0,15 % C	annealed	125	1	150	135	8	135	125	7	150	135	8	
	ca. 0,45 % C	annealed	190	2	130	120	8	120	110	7	130	120	8	
	ca. 0,45 % C	tempered	250	3	120	110	6	110	100	5	120	110	6	
	ca. 0,75 % C	annealed	270	4	110	100	6	100	90	5	110	100	6	
	ca. 0,75 % C	tempered	300	5	100	90	6	90	85	5	100	90	6	
P Low-alloyed steel		annealed	180	6	130	120	8	120	110	7	130	120	8	
		tempered	275	7	110	100	6	100	90	5	110	100	6	
		tempered	300	8	100	90	6	90	85	5	100	90	6	
		tempered	350	9	90	85	6	85	80	5	90	85	6	
P High-alloyed steel and high-alloyed tool steel		annealed	200	10	120	110	8	110	100	7	120	110	8	
		hardened and tempered	325	11	100	90	6	90	85	5	100	90	6	
M Stainless steel	ferritic/martensitic	annealed	200	12	80	75	5	75	70	5	80	75	5	
	martensitic	tempered	240	13	55	50	5	50	45	5	55	50	5	
	austenitic	quench hardened	180	14	60	55	5	55	50	5	60	55	5	
	austenitic-ferritic		230	15	50	45	5	45	45	5	50	45	5	
K Grey cast iron	perlite/ferritic		180	16	135	125	8	125	115	7	135	125	8	
	perlite (martensitic)		260	17	110	100	8	100	90	7	110	100	8	
	ferritic		160	18	120	110	8	110	100	7	120	110	8	
	perlite		250	19	80	75	8	75	70	7	80	75	8	
	ferritic		130	20	130	120	8	120	110	7	130	120	8	
K Malleable cast iron	perlite		230	21	80	75	8	75	70	7	80	75	8	
N Aluminium wrought alloys	cannot be hardened		60	22										
	hardenable	hardened	100	23										
	Cast aluminium alloys	≤ 12% Si, cannot be hardened		75	24									
		≤ 12% Si, hardenable	hardened	90	25									
		> 12% Si, cannot be hardened		130	26									
N Copper and copper alloys (bronze/brass)	machining steel, PB> 1%		110	27										
	CuZn, CuSnZn		90	28										
	CuSn, Pb-free copper, electrolytic copper		100	29										
S Heat-resistant alloys	Fe-based alloys	annealed	200	30										
		hardened	280	31										
	Ni or Co base	annealed	250	32										
		hardened	350	33										
		cast	320	34										
S Titanium alloys	pure titanium		R _m 400	35										
	α and β alloys	hardened	R _m 1050	36										
H Hardened steel		hardened and tempered	55 HRC	37										
		hardened and tempered	60 HRC	38										
	Hard cast iron	cast	400	39										
X Hardened cast iron		hardened and tempered	55 HRC	40										
	Non-metallic materials	Thermoplasts		41										
		Thermosetting plastics			42									
		Plastic, glass-fibre reinforced GFRP			43									
Plastic, carbon fibre reinforced CFRP				44										
X Graphite				45										
	Wood			46										

Note: The given cutting values are guide values, which were determined under ideal conditions. The values have to be adapted in individual cases. With hole depths of 5xD adjust the cutting data accordingly to the application. f-group = feed rate recommendations on page C126. For examples of material for cutting tool groups view page D22.

Recommend feed rate

Solid carbide drilling

f-group	Feed rate [mm]																				
	Ø1	Ø2	Ø3	Ø4	Ø5	Ø6	Ø7	Ø8	Ø9	Ø10	Ø11	Ø12	Ø13	Ø14	Ø15	Ø16	Ø17	Ø18	Ø19	Ø20	
4	1	0,01	0,02	0,03	0,04	0,04	0,05	0,05	0,06	0,06	0,07	0,07	0,08	0,08	0,09	0,09	0,09	0,09	0,10	0,10	
	2	0,01	0,02	0,03	0,04	0,05	0,06	0,06	0,06	0,07	0,07	0,08	0,09	0,09	0,10	0,10	0,10	0,10	0,11	0,11	0,11
	3	0,01	0,02	0,04	0,05	0,06	0,06	0,07	0,07	0,08	0,09	0,09	0,10	0,10	0,11	0,11	0,12	0,12	0,12	0,13	0,13
	4	0,02	0,03	0,04	0,06	0,06	0,07	0,08	0,09	0,09	0,10	0,11	0,11	0,12	0,12	0,13	0,13	0,14	0,14	0,15	0,15
	5	0,02	0,03	0,05	0,06	0,07	0,09	0,09	0,10	0,11	0,11	0,12	0,13	0,14	0,14	0,15	0,15	0,16	0,16	0,17	0,17
	6	0,02	0,04	0,06	0,07	0,09	0,10	0,11	0,11	0,12	0,13	0,14	0,15	0,16	0,17	0,17	0,18	0,18	0,19	0,19	0,20
	7	0,02	0,04	0,06	0,09	0,10	0,11	0,12	0,13	0,14	0,15	0,16	0,17	0,18	0,19	0,20	0,20	0,21	0,22	0,22	0,23
5	8	0,03	0,05	0,07	0,10	0,11	0,13	0,14	0,15	0,16	0,17	0,18	0,20	0,21	0,22	0,23	0,23	0,24	0,25	0,26	0,26
	9	0,03	0,06	0,08	0,11	0,13	0,15	0,16	0,17	0,18	0,20	0,21	0,23	0,24	0,25	0,26	0,27	0,28	0,29	0,29	0,30
	10	0,04	0,07	0,10	0,13	0,15	0,17	0,19	0,20	0,21	0,23	0,24	0,26	0,27	0,29	0,30	0,31	0,32	0,33	0,34	0,35
	11	0,04	0,07	0,11	0,15	0,17	0,20	0,21	0,23	0,24	0,26	0,28	0,30	0,32	0,33	0,35	0,36	0,37	0,38	0,39	0,40
	12	0,05	0,09	0,13	0,17	0,20	0,23	0,25	0,26	0,28	0,30	0,32	0,35	0,36	0,38	0,40	0,41	0,42	0,44	0,45	0,46
	13	0,05	0,10	0,15	0,20	0,23	0,26	0,28	0,30	0,32	0,35	0,37	0,40	0,42	0,44	0,46	0,47	0,49	0,50	0,52	0,53
	14	0,06	0,11	0,17	0,23	0,26	0,30	0,33	0,35	0,37	0,40	0,43	0,46	0,48	0,50	0,53	0,54	0,56	0,58	0,59	0,61
	15	0,07	0,13	0,20	0,26	0,30	0,35	0,37	0,40	0,43	0,46	0,49	0,53	0,55	0,58	0,61	0,62	0,64	0,66	0,68	0,70

Note: The given cutting values are guide values, which were determined under ideal conditions.
The values have to be adapted in individual cases.

1. Select the appropriate product series.
2. Determine the immersion.
3. Select the used material and read the cutting speed.
4. Determine the feed rate group and have a look at the appropriate feed rate recommendations.
5. Select the diameter of tool and determine the immersion.

A

Turning

B

Milling

C

Drilling

D

Technical Information

E

Index

Solid carbide drills

Material group	Composition / structure / heat treatment		Brinell hardness HB	Machining group	Starting values for cutting speed v_c [m/min]								
					SL-Drill		SL-Drill		SP-Drill		ST-Drill		
					12-15xD		20-30xD		3xD		3-5xD		
					KDG 303		KDG 303		KDG 303		KDG 303		
					Coolant								
					Int.	f-group	Int.	f-group	Int.	f-group	Int.	f-group	
P Unalloyed steel	approx. 0,15 % C	annealed	125	1	130	7	95	7	165	8	150	8	
	approx. 0,45 % C	annealed	190	2	110	7	80	7	145	8	130	8	
	approx. 0,45 % C	tempered	250	3	100	5	70	5	135	6	120	6	
	approx. 0,75 % C	annealed	270	4	85	5	60	5	125	6	110	6	
	approx. 0,75 % C	tempered	300	5	75	5	55	5	110	6	100	6	
P Low-alloyed steel		annealed	180	6	110	7	80	7	145	8	130	8	
		tempered	275	7	85	5	60	5	125	6	110	6	
		tempered	300	8	75	5	55	5	110	6	100	6	
		tempered	350	9	65	5	50	5	100	6	90	6	
P High-alloyed steel and high-alloyed tool steel		annealed	200	10	100	7	70	7	135	8	120	8	
		hardened and tempered	325	11	75	5	55	5	110	6	100	6	
M Stainless steel	ferritic/martensitic	annealed	200	12	60	4	55	4	90	5	80	5	
	martensitic	tempered	240	13	35	4	30	4	65	5	55	5	
	austenitic	quench hardened	180	14	40	4	35	4	70	5	60	5	
	austenitic-ferritic		230	15	35	4	35	4	55	5	50	5	
K Grey cast iron	perlitic/ferritic		180	16	125	7	90	7	150	8			
	perlitic (martensitic)		260	17	100	7	70	7	125	8			
K Cast iron with spheroidal graphite	ferritic		160	18	110	7	80	7	135	8			
	perlitic		250	19	70	7	50	7	90	8			
K Malleable cast iron	ferritic		130	20	120	7	85	7	145	8			
	perlitic		230	21	70	7	50	7	90	8			
N Aluminium wrought alloys	cannot be hardened		60	22	150	8	105	8	170	8			
	hardenable	hardened	100	23	150	8	105	8	170	8			
	Cast aluminium alloys	$\leq 12\%$ Si, cannot be hardened		75	24	150	8	105	8	170	8		
		$\leq 12\%$ Si, hardenable	hardened	90	25	150	8	105	8	170	8		
		$> 12\%$ Si, cannot be hardened		130	26	150	8	105	8	170	8		
Copper and copper alloys (bronze/brass)	machining steel, PB > 1%		110	27	150	8	105	8	170	8			
	CuZn, CuSnZn		90	28	150	8	105	8	170	8			
	CuSn, Pb-free copper, electrolytic copper		100	29	150	8	105	8	170	8			
S Heat-resistant alloys	Fe-based alloys	annealed	200	30	30	4	20	4	30	5	30	5	
		hardened	280	31	35	4	25	4	35	5	35	5	
	Ni or Co bass	annealed	250	32	35	4	25	4	35	5	35	5	
		hardened	350	33	15	4	10	4	15	5	15	5	
		cast	320	34	15	4	10	4	15	5	15	5	
Titanium alloys	pure titanium	R_m 400	35	30	4	20	4	30	5	30	5		
	α and β alloys	hardened R_m 1050	36	30	4	20	4	30	5	30	5		
H Hardened steel		hardened and tempered	55 HRC	37									
		hardened and tempered	60 HRC	38									
	Hard cast iron	cast	400	39									
H Hardened cast iron		hardened and tempered	55 HRC	40									
X Non-metallic materials	Thermoplasts			41									
	Thermosetting plastics			42									
	Plastic, glass-fibre reinforced GFRP			43									
	Plastic, carbon fibre reinforced CFRP			44									
	Graphite			45									
X Wood				46									

Note: The given cutting values are guide values, which were determined under ideal conditions. The values have to be adapted in individual cases. With hole depths of 5xD adjust the cutting data accordingly to the application. f-group = feed rate recommendations on page C148. For examples of material for cutting tool groups view page D11.

Recommended feed rate

Solid carbide drills

f-group	Feed rate [mm]																			
	Ø1	Ø2	Ø3	Ø4	Ø5	Ø6	Ø7	Ø8	Ø9	Ø10	Ø11	Ø12	Ø13	Ø14	Ø15	Ø16	Ø17	Ø18	Ø19	Ø20
1	0,01	0,02	0,03	0,04	0,04	0,05	0,05	0,06	0,06	0,06	0,07	0,07	0,08	0,08	0,09	0,09	0,09	0,09	0,10	0,10
2	0,01	0,02	0,03	0,04	0,05	0,06	0,06	0,06	0,07	0,07	0,08	0,09	0,09	0,09	0,10	0,10	0,10	0,10	0,11	0,11
3	0,01	0,02	0,04	0,05	0,06	0,06	0,07	0,07	0,08	0,09	0,09	0,10	0,10	0,11	0,11	0,12	0,12	0,12	0,13	0,13
4	0,02	0,03	0,04	0,06	0,06	0,07	0,08	0,09	0,09	0,10	0,11	0,11	0,12	0,12	0,13	0,13	0,14	0,14	0,15	0,15
5	0,02	0,03	0,05	0,06	0,07	0,09	0,09	0,10	0,11	0,11	0,12	0,13	0,14	0,14	0,15	0,15	0,16	0,16	0,17	0,17
6	0,02	0,04	0,06	0,07	0,09	0,10	0,11	0,11	0,12	0,13	0,14	0,15	0,16	0,17	0,17	0,18	0,18	0,19	0,19	0,20
7	0,02	0,04	0,06	0,09	0,10	0,11	0,12	0,13	0,14	0,15	0,16	0,17	0,18	0,19	0,20	0,20	0,21	0,22	0,22	0,23
8	0,03	0,05	0,07	0,10	0,11	0,13	0,14	0,15	0,16	0,17	0,18	0,20	0,21	0,22	0,23	0,23	0,24	0,25	0,26	0,26
9	0,03	0,06	0,08	0,11	0,13	0,15	0,16	0,17	0,18	0,20	0,21	0,23	0,24	0,25	0,26	0,27	0,28	0,29	0,29	0,30
10	0,04	0,07	0,10	0,13	0,15	0,17	0,19	0,20	0,21	0,23	0,24	0,26	0,27	0,29	0,30	0,31	0,32	0,33	0,34	0,35
11	0,04	0,07	0,11	0,15	0,17	0,20	0,21	0,23	0,24	0,26	0,28	0,30	0,32	0,33	0,35	0,36	0,37	0,38	0,39	0,40
12	0,05	0,09	0,13	0,17	0,20	0,23	0,25	0,26	0,28	0,30	0,32	0,35	0,36	0,38	0,40	0,41	0,42	0,44	0,45	0,46
13	0,05	0,10	0,15	0,20	0,23	0,26	0,28	0,30	0,32	0,35	0,37	0,40	0,42	0,44	0,46	0,47	0,49	0,50	0,52	0,53
14	0,06	0,11	0,17	0,23	0,26	0,30	0,33	0,35	0,37	0,40	0,43	0,46	0,48	0,50	0,53	0,54	0,56	0,58	0,59	0,61
15	0,07	0,13	0,20	0,26	0,30	0,35	0,37	0,40	0,43	0,46	0,49	0,53	0,55	0,58	0,61	0,62	0,64	0,66	0,68	0,70

Note: The given cutting values are guide values, which were determined under ideal conditions.
The values have to be adapted in individual cases.

A

Turning

B

Milling

C

Drilling

D

Technical
Information

E

Index

Special tools – fine-tuned to your specific application

Special applications call for special solutions optimised to the task. Special tools are able to deliver real benefits from a commercial, technical or process perspective over standard tool solutions in all industry sectors. We work with you to assess the potential in each individual case, taking into account the general conditions available at your company ZCC Cutting Tools Europe's R&D department then develops a custom solution for you at our EU headquarters in Düsseldorf to keep your machining costs as low as possible.

Why opt for special tools from ZCC Cutting Tools?

We develop customised tool solutions for you for a wide range of machining operations. We work closely with you from day one to design tools optimised to meet your needs and priorities. From design and production to logistics, we draw on many years of experience to offer a full range of expert services. Take advantage of our expertise to ensure the long-term success of your company.

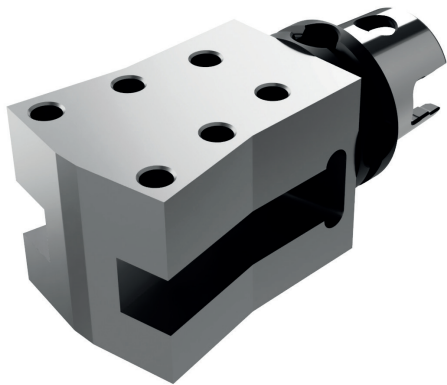

Example: Special tool holder



Example: Special solid carbide step drill

The easy way to order your custom-made special tool

Are there specific applications at your company where having custom tools tailored to your unique needs would deliver real benefits both in terms of logistics and at a technical and commercial level? ZCC Cutting Tools is there to advise and assist you during the planning, development and ordering process. Use our new online tool to request a special tool and get your personal quotation in just a few short steps (www.zccct-europe.com).

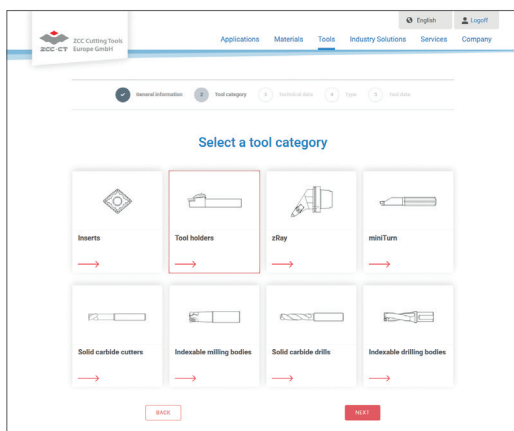

'Online tool for special tools' launch page where you can select the tool category

Selecting the tool category

Scan the QR code on this page to go directly to the launch page of our online tool where you can request the special tool you need. You can begin by selecting the tool category you need. It's that easy.

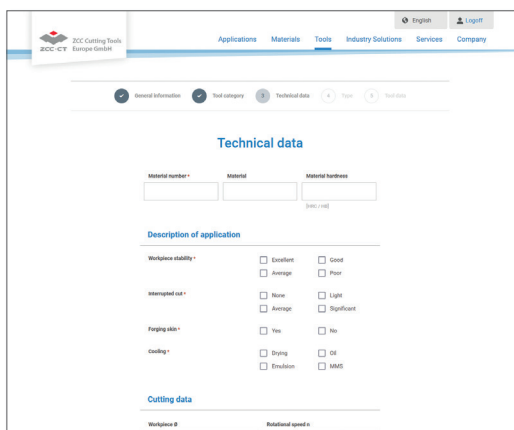

Define the relevant tool parameters

Defining the tool parameters

You are now guided step by step through the process. You can also securely upload your drawings, diagrams and 3D models (where available).

The fast and direct way to order your special tool from ZCC Cutting Tools Europe.



Now go directly to the new **special tool form** on our website and get started.

SOLID CARBIDE REAMERS

Solid carbide reamers

Product overview	C154
Grade overview	C155
System code – solid carbide reamers	C156
Solid carbide reamers	C157-C163
Recommended cutting data	C164-C169
Trouble shooting	C206
Technical information	C210
Special tools	C170-C171



A

Turning

B

Milling

C

Drilling

D



Technical
Information

E

Index

A

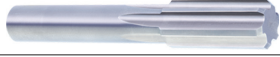
Turning

Products	Solid carbide reamers	Ø	Application						Type	Page
			P	M	K	N	S	H		
3101H7		4-20			✓	✓			Right helical flute	C157
3102H7		4-20			✓	✓			Straight flute	C158
3112H7		4-20	✓		✓				Straight flute with inner hole	C159
3103H7		4-20			✓	✓			Left helical flute	C163

✓ Very suitable ✓ Suitable

B

Milling

C

Drilling

D

Technical Information

E

Index

Coated cemented carbide PVD

Grade	Grade description
-------	-------------------

KRG102	PVD coated P10–P20/K10–K20 carbide substrate for steel and cast iron.
---------------	---

Uncoated cemented carbide

Grade	Grade description
-------	-------------------

YK10F	Uncoated N10/K10 carbide substrate for cast iron and non ferrous materials.
--------------	---

A

Turning

B

Milling

C

Drilling

DTechnical
Information**E**

Index

3 1 0 1 H7 – 0850

1

2

3

4

5

6

A

Turning

Type	
Code	Description
3	Reamer

Shank type	
Code	Description
1	Straight shank
2	Straight shank DIN10
5	Straight shank DIN 6535 HA
9	Morse taper shank

B

Milling

1

2

Coolant supply	
Code	Description
0	External
1	Internal

Flute	
Code	Description
1	Right-hand twist
2	Straight flute
3	Left-hand twist

3

4

C

Drilling

Classe de tolérance	
Code	Description
H7	The tolerance class of the reamed hole is equivalent to H7 (GB/T1800-1804)

Diameter [mm]	
Code	Description
0850	8,5
...	

5

6

D

Technical Information

E

Index



a Reaming

Reamer, right-hand twist

Cast iron, non-ferrous metals

3101H7



– Factory standard

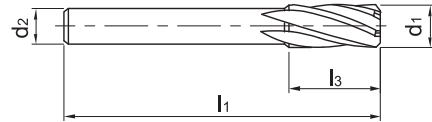

Article	*	Dimensions [mm]				Teeth	Grade
		d ₁	d ₂ (h6)	l ₁	l ₃		YK10F
3101H7-0400		4	3.55	56	20	4	●
3101H7-0500		5	4	63	22	6	○
3101H7-0600		6	5	63	22	6	○
3101H7-0700		7	6.3	71	25	6	○
3101H7-0800		8	6.3	71	25	6	○
3101H7-0900		9	8	71	25	6	○
3101H7-1000		10	8	71	25	6	○
3101H7-1200		12	10	80	28	6	○
3101H7-1300		13	10	80	28	6	○
3101H7-1450		14.5	12.5	90	32	6	○
3101H7-1600		16	12.5	90	32	6	○

● Ex stock ○ On demand

* With internal cooling

Application field

P	M	K	N	S	H
		✓	✓		

✓ Very suitable

✓ Suitable

System code > C156

Machining instructions > C201

Cutting data > C164

Nonstandard order > C170

A

Reamer, straight flute **Cast iron, non-ferrous metals**

Turning

3102H7



– Factory standard

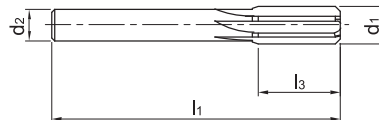

B

Milling

Article	*	Dimensions [mm]				Teeth	Grade
		d ₁	d ₂ (h6)	l ₁	l ₃		YK10F
3102H7-0400		4	3.55	56	20	4	○
3102H7-0500		5	4	63	22	6	○
3102H7-0600		6	5	63	22	6	○
3102H7-1000		10	8	71	25	6	○
3102H7-1050		10.5	8	71	25	6	○
3102H7-1100		11	10	80	28	6	○
3102H7-1300		13	10	80	28	6	○
3102H7-1400		14	12.5	90	32	6	○

● Ex stock ○ On demand

* With internal cooling

C

Drilling

Application field						
P	M	K	N	S	H	
		✓	✓			✓ Very suitable
						✓ Suitable

D

Technical Information

E

Index

System code > C156

Machining instructions > C201

Cutting data > C164

Nonstandard order > C170

Reamer, straight flute

Steel, cast iron

3112H7



- Factory standard
- Coolant exit, axial concentric

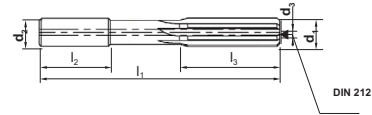

Article	*	Dimensions [mm]						Teeth	Grade
		d ₁	d ₂ (h6)	d ₃ (m7)	l ₁	l ₂	l ₃		KRG102
3112H7-0295	*	2.95	4	0.6	70	28	20	4	○
3112H7-0296	*	2.96	4	0.6	70	28	20	4	○
3112H7-0297	*	2.97	4	0.6	70	28	20	4	○
3112H7-0298	*	2.98	4	0.6	70	28	20	4	○
3112H7-0299	*	2.99	4	0.6	70	28	20	4	○
3112H7-0300	*	3	3.5	0.6	70	28	20	4	●
3112H7-0301	*	3.01	4	0.6	70	28	20	4	●
3112H7-0302	*	3.02	4	0.6	70	28	20	4	●
3112H7-0303	*	3.03	4	0.6	70	28	20	4	●
3112H7-0318	*	3.18	4	0.6	70	28	20	4	○
3112H7-0348	*	3.48	4	0.6	70	28	20	4	○
3112H7-0350	*	3.5	4	0.6	70	28	20	4	○
3112H7-0395	*	3.95	4	0.6	70	28	20	4	○
3112H7-0396	*	3.96	4	0.6	70	28	20	4	○
3112H7-0397	*	3.97	4	0.6	70	28	20	4	○
3112H7-0398	*	3.98	4	0.6	70	28	20	4	○
3112H7-0399	*	3.99	4	0.6	70	28	20	4	○
3112H7-0400	*	4	4	0.6	70	28	20	6	●
3112H7-0401	*	4.01	4	1	70	28	20	4	●
3112H7-0402	*	4.02	4	1	70	28	20	4	●
3112H7-0403	*	4.03	4	1	70	28	20	4	●
3112H7-0404	*	4.04	4	1	70	28	20	4	○
3112H7-0405	*	4.05	4	1	70	28	20	4	○
3112H7-0407	*	4.07	4	1	70	28	20	4	○
3112H7-0408	*	4.08	4	1	70	28	20	4	●
3112H7-0450	*	4.5	5	1	70	28	20	4	○
3112H7-0452	*	4.52	5	1	70	28	20	4	○
3112H7-0457	*	4.57	5	1	70	28	20	4	○
3112H7-0495	*	4.95	5	1	70	28	22	6	○
3112H7-0496	*	4.96	5	1	70	28	22	6	○
3112H7-0497	*	4.97	5	1	70	28	22	6	○
3112H7-0498	*	4.98	5	1	70	28	22	6	○
3112H7-0499	*	4.99	5	1	70	28	22	6	○
3112H7-0500	*	5	5	1	70	28	22	6	●
3112H7-0501	*	5.01	5	1	70	28	22	6	●
3112H7-0502	*	5.02	5	1	70	28	22	6	●
3112H7-0503	*	5.03	5	1	70	28	22	6	●

● Ex stock ○ On demand

* With internal cooling

Application field

P	M	K	N	S	H
✓		✓			

✓ Very suitable

✓ Suitable

System code > C156

Machining instructions > C201

Cutting data > C164

Nonstandard order > C170



Reamer, straight flute

Steel, cast iron

3112H7



- Factory standard
- Coolant exit, axial concentric

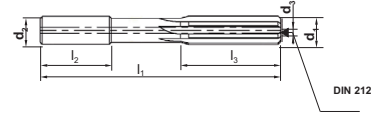

Article	*	Dimensions [mm]						Teeth	Grade
		d ₁	d ₂ (h6)	d ₃ (m7)	l ₁	l ₂	l ₃		
3112H7-0504	*	5.04	5	1	70	28	22	6	○
3112H7-0505	*	5.05	5	1	70	28	22	6	○
3112H7-0550	*	5.5	6	1	70	28	22	6	○
3112H7-0553	*	5.53	6	1	70	28	22	6	○
3112H7-0561	*	5.61	6	1	70	28	22	6	○
3112H7-0593	*	5.93	6	1	70	28	22	6	○
3112H7-0595	*	5.95	6	1	100	36	22	6	●
3112H7-0596	*	5.96	6	1	100	36	22	6	●
3112H7-0597	*	5.97	6	1	100	36	22	6	●
3112H7-0598	*	5.98	6	1	100	36	22	6	●
3112H7-0599	*	5.99	6	1	100	36	22	6	●
3112H7-0600	*	6	6	1	100	36	22	6	●
3112H7-0601	*	6.01	6	1.3	100	36	22	6	●
3112H7-0602	*	6.02	6	1.3	100	36	22	6	●
3112H7-0603	*	6.03	6	1.3	100	36	22	6	●
3112H7-0635	*	6.35	8	1.3	100	36	22	6	○
3112H7-0650	*	6.5	8	1.3	100	36	22	6	○
3112H7-0655	*	6.55	8	1.3	100	36	22	6	○
3112H7-0693	*	6.93	8	1.3	100	36	22	6	○
3112H7-0695	*	6.95	8	1.3	110	42	25	6	○
3112H7-0696	*	6.96	8	1.3	110	42	25	6	○
3112H7-0697	*	6.97	8	1.3	110	42	25	6	○
3112H7-0698	*	6.98	8	1.3	110	42	25	6	○
3112H7-0699	*	6.99	8	1.3	110	42	25	6	○
3112H7-0700	*	7	8	1.3	110	42	25	6	●
3112H7-0701	*	7.01	8	1.3	110	42	25	6	●
3112H7-0702	*	7.02	8	1.3	110	42	25	6	●
3112H7-0703	*	7.03	8	1.3	110	42	25	6	●
3112H7-0750	*	7.5	8	1.3	110	42	25	6	○
3112H7-0770	*	7.7	8	1.3	110	42	25	6	○
3112H7-0793	*	7.93	8	1.3	110	42	25	6	○
3112H7-0795	*	7.95	8	1.3	110	42	25	6	○
3112H7-0796	*	7.96	8	1.3	110	42	25	6	○
3112H7-0797	*	7.97	8	1.3	110	42	25	6	○
3112H7-0798	*	7.98	8	1.3	110	42	25	6	○
3112H7-0799	*	7.99	8	1.3	110	42	25	6	○
3112H7-0800	*	8	8	1.3	110	42	25	6	●

- Ex stock ○ On demand
- * With internal cooling

Application field

P	M	K	N	S	H
✓		✓			

- ✓ Very suitable
- ✓ Suitable

System code > C156

Machining instructions > C201

Cutting data > C164

Nonstandard order > C170

Reamer, straight flute

Steel, cast iron

3112H7



- Factory standard
- Coolant exit, axial concentric

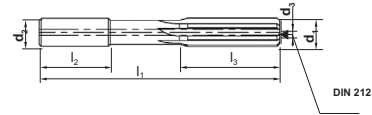

Article	*	Dimensions [mm]						Teeth	Grade
		d ₁	d ₂ (h6)	d ₃ (m7)	l ₁	l ₂	l ₃		KRG102
3112H7-0801	*	8.01	8	2	110	42	25	6	●
3112H7-0802	*	8.02	8	2	110	42	25	6	●
3112H7-0803	*	8.03	8	2	110	42	25	6	●
3112H7-0880	*	8.8	10	2	110	42	25	6	○
3112H7-0885	*	8.85	10	2	110	42	25	6	○
3112H7-0900	*	9	10	2	110	42	25	6	●
3112H7-0901	*	9.01	10	2	110	42	25	6	●
3112H7-0902	*	9.02	10	2	110	42	25	6	○
3112H7-0903	*	9.03	10	2	110	42	25	6	●
3112H7-0920	*	9.2	10	2	110	42	25	6	○
3112H7-0930	*	9.3	10	2	110	42	25	6	○
3112H7-0993	*	9.93	10	2	110	42	25	6	○
3112H7-0995	*	9.95	10	2	110	38	25	6	○
3112H7-0996	*	9.96	10	2	110	38	25	6	○
3112H7-0997	*	9.97	10	2	110	38	25	6	○
3112H7-0998	*	9.98	10	2	110	38	25	6	○
3112H7-0999	*	9.99	10	2	110	38	25	6	○
3112H7-1000	*	10	10	2	110	38	25	6	●
3112H7-1001	*	10.01	10	2	110	38	25	6	●
3112H7-1002	*	10.02	10	2	110	38	25	6	●
3112H7-1003	*	10.03	10	2	110	38	25	6	●
3112H7-1024	*	10.24	10	2	110	38	24	6	○
3112H7-1100	*	11	12	2	110	38	28	6	●
3112H7-1101	*	11.01	10	2	110	38	24	6	●
3112H7-1102	*	11.02	10	2	110	38	24	6	○
3112H7-1103	*	11.03	10	2	110	38	24	6	●
3112H7-1155	*	11.55	12	2	110	38	28	6	○
3112H7-1195	*	11.95	12	2	110	38	28	6	○
3112H7-1196	*	11.96	12	2	110	38	28	6	○
3112H7-1197	*	11.97	12	2	110	38	28	6	○
3112H7-1198	*	11.98	12	2	110	38	28	6	○
3112H7-1199	*	11.99	12	2	110	38	28	6	○
3112H7-1200	*	12	12	2	110	38	28	6	●
3112H7-1201	*	12.01	12	2	110	38	28	6	●
3112H7-1202	*	12.02	12	2	110	38	28	6	●
3112H7-1203	*	12.03	12	2	110	38	28	6	●
3112H7-1300	*	13	14	2	110	38	28	6	●

● Ex stock ○ On demand

* With internal cooling

Application field

P	M	K	N	S	H
✓		✓			

✓ Very suitable

✓ Suitable

System code > C156

Machining instructions > C201

Cutting data > C164

Nonstandard order > C170



A

Reamer, straight flute **Steel, cast iron**

Turning

3112H7



- Factory standard
- Coolant exit, axial concentric

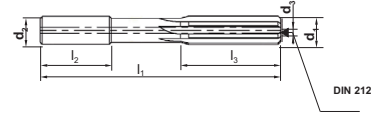

B

Milling

Article	*	Dimensions [mm]						Teeth	Grade
		d ₁	d ₂ (h6)	d ₃ (m7)	l ₁	l ₂	l ₃		KRG102
3112H7-1301	*	13.01	14	2	110	38	28	6	●
3112H7-1302	*	13.02	14	2	110	38	28	6	●
3112H7-1303	*	13.03	14	2	110	38	28	6	●
3112H7-1394	*	13.94	14	2	110	38	28	6	○
3112H7-1400	*	14	14	2	110	38	32	6	●
3112H7-1401	*	14.01	14	2	110	38	28	6	●
3112H7-1402	*	14.02	14	2	110	38	28	6	●
3112H7-1403	*	14.03	14	2	110	38	28	6	●
3112H7-1500	*	15	16	2	110	38	32	6	●
3112H7-1501	*	15.01	16	2	110	38	28	6	●
3112H7-1502	*	15.02	16	2	110	38	28	6	○
3112H7-1503	*	15.03	16	2	110	38	28	6	●
3112H7-1565	*	15.65	16	2	110	38	28	6	○
3112H7-1593	*	15.93	16	2	110	38	28	6	○
3112H7-1595	*	15.95	16	2	150	52	32	6	○
3112H7-1596	*	15.96	16	2	150	52	32	6	○
3112H7-1597	*	15.97	16	2	150	52	32	6	○
3112H7-1598	*	15.98	16	2	150	52	32	6	○
3112H7-1599	*	15.99	16	2	150	52	32	6	○
3112H7-1600	*	16	16	2	150	52	32	6	●
3112H7-1601	*	16.01	16	3	150	52	32	6	●
3112H7-1602	*	16.02	16	3	150	52	32	6	○
3112H7-1603	*	16.03	16	3	150	52	32	6	●
3112H7-1800	*	18	18	3	150	52	36	6	●
3112H7-2000	*	20	20	3	150	50	36	6	●

● Ex stock ○ On demand

* With internal cooling

C

Drilling

D

Technical Information

Application field

P	M	K	N	S	H
✓		✓			

✓ Very suitable

✓ Suitable

E

Index

System code > C156

Machining instructions > C201

Cutting data > C164

Nonstandard order > C170

Reamer, left-hand twist

Cast iron, non-ferrous metals

3103H7



– Factory standard

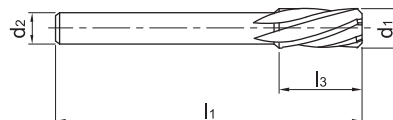
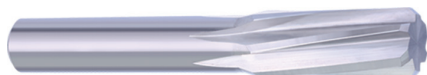

Article	*	Dimensions [mm]				Teeth	Grade
		d ₁	d ₂ (h6)	l ₁	l ₃		YK10F
3103H7-0400		4	3.55	56	20	4	○
3103H7-0500		5	4	63	22	6	○
3103H7-0600		6	5	63	22	6	○
3103H7-0800		8	6.3	71	25	6	○
3103H7-0950		9.5	8	71	25	6	○
3103H7-1000		10	8	71	25	6	○
3103H7-1150		11.5	10	80	28	6	○
3103H7-1200		12	10	80	28	6	○
3103H7-1600		16	12.5	90	32	6	○
3103H7-1800		18	16	100	36	6	○

● Ex stock ○ On demand

* With internal cooling

Application field					
P	M	K	N	S	H
		✓	✓		

✓ Very suitable

✓ Suitable

System code > C156

Machining instructions > C201

Cutting data > C164

Nonstandard order > C170

Guide for recommended cutting data – Solid carbide reamers

Solid carbide reamers

Material group	Composition / structure / heat treatment		Brinell hardness HB	Machining group	Starting values for cutting speed v_c [m/min]							
					3101H7		3102H7		3112H7		3103H7	
					YK10F		YK10F		KRG102		YK10F	
					Coolant							
				external	f-group	external	f-group	internal	f-group	external	f-group	
P Unalloyed steel	ca. 0,15 % C	annealed	125	1								
	ca. 0,45 % C	annealed	190	2								
	ca. 0,45 % C	tempered	250	3								
	ca. 0,75 % C	annealed	270	4								
	ca. 0,75 % C	tempered	300	5								
P Low-alloyed steel		annealed	180	6						75	5	
		tempered	275	7						60	5	
		tempered	300	8						55	5	
		tempered	350	9						55	5	
P High-alloyed steel and high-alloyed tool steel		annealed	200	10						70	5	
		hardened and tempered	325	11						55	5	
M Stainless steel	ferritic/martensitic	annealed	200	12								
	martensitic	tempered	240	13								
	austenitic	quench hardened	180	14								
	austenitic-ferritic		230	15								
K Grey cast iron	perlitic/ferritic		180	16	23	5	23	5	75	5	23	5
	perlitic (martensitic)		260	17	19	5	19	5	60	5	19	5
	ferritic		160	18	19	5	19	5	60	5	19	5
	perlitic		250	19	17	5	17	5	50	5	17	5
K Cast iron with spheroidal graphite	ferritic		130	20	23	5	23	5	75	5	23	5
	perlitic		230	21	14	5	14	5	55	5	14	5
N Aluminium wrought alloys	cannot be hardened		60	22	45	6	45	6			45	6
	hardenable	hardened	100	23	40	6	40	6			40	6
	≤ 12% Si, cannot be hardened		75	24	37	6	37	6			37	6
	≤ 12% Si, hardenable	hardened	90	25	35	6	35	6			35	6
	> 12% Si, cannot be hardened		130	26	32	6	32	6			32	6
N Cast aluminium alloys	machining steel, PB > 1%		110	27	37	6	37	6			37	6
	CuZn, CuSnZn		90	28	34	6	34	6			34	6
	CuSn, Pb-free copper, electrolytic copper		100	29	37	6	37	6			37	6
S Copper and copper alloys (bronze/brass)	Fe-based alloys	annealed	200	30								
		hardened	280	31								
	Ni or Co base	annealed	250	32								
		hardened	350	33								
		cast	320	34								
S Titanium alloys	pure titanium		R _m 400	35								
	α and β alloys	hardened	R _m 1050	36								
H Hardened steel		hardened and tempered	55 HRC	37								
		hardened and tempered	60 HRC	38								
	Hard cast iron	cast	400	39								
H Hardened cast iron		hardened and tempered	55 HRC	40								
X Non-metallic materials	Thermoplasts			41								
	Thermosetting plastics			42								
	Plastic, glass-fibre reinforced GFRP			43								
	Plastic, carbon fibre reinforced CFRP			44								
	Graphite			45								
	Wood			46								

Note: The given cutting values are guide values, which were determined under ideal conditions. The values have to be adapted in individual cases. With hole depths of 5xD adjust the cutting data accordingly to the application. f-group = feed rate recommendations on page C140. For examples of material for cutting tool groups view page D22.

Recommend feed rate

Solid carbide reamers

f _r -group	Feed rate [mm]																				
	Ø1	Ø2	Ø3	Ø4	Ø5	Ø6	Ø7	Ø8	Ø9	Ø10	Ø11	Ø12	Ø13	Ø14	Ø15	Ø16	Ø17	Ø18	Ø19	Ø20	
4	1	0,01	0,02	0,03	0,04	0,04	0,05	0,05	0,06	0,06	0,06	0,07	0,07	0,08	0,08	0,09	0,09	0,09	0,10	0,10	
	2	0,01	0,02	0,03	0,04	0,05	0,06	0,06	0,06	0,07	0,07	0,08	0,09	0,09	0,10	0,10	0,10	0,10	0,11	0,11	0,11
	3	0,01	0,02	0,04	0,05	0,06	0,06	0,07	0,07	0,08	0,09	0,09	0,10	0,10	0,11	0,11	0,12	0,12	0,12	0,13	0,13
	4	0,02	0,03	0,04	0,06	0,06	0,07	0,08	0,09	0,09	0,10	0,11	0,11	0,12	0,12	0,13	0,13	0,14	0,14	0,15	0,15
5	5	0,02	0,03	0,05	0,06	0,07	0,09	0,09	0,10	0,11	0,11	0,12	0,13	0,14	0,14	0,15	0,15	0,16	0,16	0,17	0,17
	6	0,02	0,04	0,06	0,07	0,09	0,10	0,11	0,11	0,12	0,13	0,14	0,15	0,16	0,17	0,17	0,18	0,18	0,19	0,19	0,20
	7	0,02	0,04	0,06	0,09	0,10	0,11	0,12	0,13	0,14	0,15	0,16	0,17	0,18	0,19	0,20	0,20	0,21	0,22	0,22	0,23
	8	0,03	0,05	0,07	0,10	0,11	0,13	0,14	0,15	0,16	0,17	0,18	0,20	0,21	0,22	0,23	0,23	0,24	0,25	0,26	0,26
	9	0,03	0,06	0,08	0,11	0,13	0,15	0,16	0,17	0,18	0,20	0,21	0,23	0,24	0,25	0,26	0,27	0,28	0,29	0,29	0,30
	10	0,04	0,07	0,10	0,13	0,15	0,17	0,19	0,20	0,21	0,23	0,24	0,26	0,27	0,29	0,30	0,31	0,32	0,33	0,34	0,35
	11	0,04	0,07	0,11	0,15	0,17	0,20	0,21	0,23	0,24	0,26	0,28	0,30	0,32	0,33	0,35	0,36	0,37	0,38	0,39	0,40
	12	0,05	0,09	0,13	0,17	0,20	0,23	0,25	0,26	0,28	0,30	0,32	0,35	0,36	0,38	0,40	0,41	0,42	0,44	0,45	0,46
	13	0,05	0,10	0,15	0,20	0,23	0,26	0,28	0,30	0,32	0,35	0,37	0,40	0,42	0,44	0,46	0,47	0,49	0,50	0,52	0,53
	14	0,06	0,11	0,17	0,23	0,26	0,30	0,33	0,35	0,37	0,40	0,43	0,46	0,48	0,50	0,53	0,54	0,56	0,58	0,59	0,61
	15	0,07	0,13	0,20	0,26	0,30	0,35	0,37	0,40	0,43	0,46	0,49	0,53	0,55	0,58	0,61	0,62	0,64	0,66	0,68	0,70

Note: The given cutting values are guide values, which were determined under ideal conditions.
The values have to be adapted in individual cases.

1. Select the appropriate product series.
2. Determine the immersion.
3. Select the used material and read the cutting speed.
4. Determine the feed rate group and have a look at the appropriate feed rate recommendations.
5. Select the diameter of tool and determine the immersion.

A

Turning

B

Milling

C

Drilling

D

Technical Information

E

Index

Solid carbide reamers

Material group	Composition / structure / heat treatment		Brinell hardness HB	Machining group	Starting values for cutting speed v_c [m/min]								
					3101H7		3102H7		3112H7		3103H7		
					YK10F		YK10F		KRG102		YK10F		
					Coolant								
				Ext.	f-group	Ext.	f-group	Int.	f-group	Ext.	f-group		
P Unalloyed steel	approx. 0,15 % C	annealed	125	1					85	5			
	approx. 0,45 % C	annealed	190	2					75	5			
	approx. 0,45 % C	tempered	250	3					70	5			
	approx. 0,75 % C	annealed	270	4					60	5			
	approx. 0,75 % C	tempered	300	5					55	5			
P Low-alloyed steel		annealed	180	6					75	5			
		tempered	275	7					60	5			
		tempered	300	8					55	5			
		tempered	350	9					55	5			
P High-alloyed steel and high-alloyed tool steel		annealed	200	10					70	5			
		hardened and tempered	325	11					55	5			
M Stainless steel	ferritic/martensitic	annealed	200	12									
	martensitic	tempered	240	13									
	austenitic	quench hardened	180	14									
	austenitic-ferritic		230	15									
K Grey cast iron	perlitic/ferritic		180	16	23	5	23	5	75	5	23	5	
	perlitic (martensitic)		260	17	19	5	19	5	60	5	19	5	
K Cast iron with spheroidal graphite	ferritic		160	18	19	5	19	5	60	5	19	5	
	perlitic		250	19	17	5	17	5	50	5	17	5	
K Malleable cast iron	ferritic		130	20	23	5	23	5	75	5	23	5	
	perlitic		230	21	14	5	14	5	55	5	14	5	
N Aluminium wrought alloys	cannot be hardened		60	22	45	6	45	6			45	6	
	hardenable	hardened	100	23	40	6	40	6			40	6	
	Cast aluminium alloys	$\leq 12\%$ Si, cannot be hardened		75	24	37	6	37	6			37	6
		$\leq 12\%$ Si, hardenable	hardened	90	25	35	6	35	6			35	6
		$> 12\%$ Si, cannot be hardened		130	26	32	6	32	6			32	6
N Copper and copper alloys (bronze/brass)	machining steel, PB > 1%		110	27	37	6	37	6			37	6	
	CuZn, CuSnZn		90	28	34	6	34	6			34	6	
	CuSn, Pb-free copper, electrolytic copper		100	29	37	6	37	6			37	6	
S Heat-resistant alloys	Fe-based alloys	annealed	200	30									
		hardened	280	31									
	Ni or Co bass	annealed	250	32									
		hardened	350	33									
		cast	320	34									
Titanium alloys	pure titanium		R _m 400	35									
	α and β alloys	hardened		R _m 1050	36								
H Hardened steel		hardened and tempered		55 HRC	37								
		hardened and tempered		60 HRC	38								
	Hard cast iron	cast	400	39									
H Hardened cast iron		hardened and tempered	55 HRC	40									
X Non-metallic materials	Thermoplasts			41									
	Thermosetting plastics			42									
	Plastic, glass-fibre reinforced GFRP			43									
	Plastic, carbon fibre reinforced CFRP			44									
	Graphite			45									
X Wood				46									

Note: The given cutting values are guide values, which were determined under ideal conditions.
 The values have to be adapted in individual cases.
 With hole depths of 5xD adjust the cutting data accordingly to the application.
 f-group = feed rate recommendations on page C168.
 For examples of material for cutting tool groups view page D11.

Recommended feed rate

Solid carbide reamers

f-group	Feed rate [mm]																			
	Ø1	Ø2	Ø3	Ø4	Ø5	Ø6	Ø7	Ø8	Ø9	Ø10	Ø11	Ø12	Ø13	Ø14	Ø15	Ø16	Ø17	Ø18	Ø19	Ø20
1	0,01	0,02	0,03	0,04	0,04	0,05	0,05	0,06	0,06	0,06	0,07	0,07	0,08	0,08	0,09	0,09	0,09	0,09	0,10	0,10
2	0,01	0,02	0,03	0,04	0,05	0,06	0,06	0,06	0,07	0,07	0,08	0,09	0,09	0,09	0,10	0,10	0,10	0,11	0,11	0,11
3	0,01	0,02	0,04	0,05	0,06	0,06	0,07	0,07	0,08	0,09	0,09	0,10	0,10	0,11	0,11	0,12	0,12	0,12	0,13	0,13
4	0,02	0,03	0,04	0,06	0,06	0,07	0,08	0,09	0,09	0,10	0,11	0,11	0,12	0,12	0,13	0,13	0,14	0,14	0,15	0,15
5	0,02	0,03	0,05	0,06	0,07	0,09	0,09	0,10	0,11	0,11	0,12	0,13	0,14	0,14	0,15	0,15	0,16	0,16	0,17	0,17
6	0,02	0,04	0,06	0,07	0,09	0,10	0,11	0,11	0,12	0,13	0,14	0,15	0,16	0,17	0,17	0,18	0,18	0,19	0,19	0,20
7	0,02	0,04	0,06	0,09	0,10	0,11	0,12	0,13	0,14	0,15	0,16	0,17	0,18	0,19	0,20	0,20	0,21	0,22	0,22	0,23
8	0,03	0,05	0,07	0,10	0,11	0,13	0,14	0,15	0,16	0,17	0,18	0,20	0,21	0,22	0,23	0,23	0,24	0,25	0,26	0,26
9	0,03	0,06	0,08	0,11	0,13	0,15	0,16	0,17	0,18	0,20	0,21	0,23	0,24	0,25	0,26	0,27	0,28	0,29	0,29	0,30
10	0,04	0,07	0,10	0,13	0,15	0,17	0,19	0,20	0,21	0,23	0,24	0,26	0,27	0,29	0,30	0,31	0,32	0,33	0,34	0,35
11	0,04	0,07	0,11	0,15	0,17	0,20	0,21	0,23	0,24	0,26	0,28	0,30	0,32	0,33	0,35	0,36	0,37	0,38	0,39	0,40
12	0,05	0,09	0,13	0,17	0,20	0,23	0,25	0,26	0,28	0,30	0,32	0,35	0,36	0,38	0,40	0,41	0,42	0,44	0,45	0,46
13	0,05	0,10	0,15	0,20	0,23	0,26	0,28	0,30	0,32	0,35	0,37	0,40	0,42	0,44	0,46	0,47	0,49	0,50	0,52	0,53
14	0,06	0,11	0,17	0,23	0,26	0,30	0,33	0,35	0,37	0,40	0,43	0,46	0,48	0,50	0,53	0,54	0,56	0,58	0,59	0,61
15	0,07	0,13	0,20	0,26	0,30	0,35	0,37	0,40	0,43	0,46	0,49	0,53	0,55	0,58	0,61	0,62	0,64	0,66	0,68	0,70

Note: The given cutting values are guide values, which were determined under ideal conditions.
The values have to be adapted in individual cases.

A

Turning

B

Milling

C

Drilling

D

Technical Information

E

Index

Special tools – fine-tuned to your specific application

Special applications call for special solutions optimised to the task. Special tools are able to deliver real benefits from a commercial, technical or process perspective over standard tool solutions in all industry sectors. We work with you to assess the potential in each individual case, taking into account the general conditions available at your company ZCC Cutting Tools Europe's R&D department then develops a custom solution for you at our EU headquarters in Düsseldorf to keep your machining costs as low as possible.

Why opt for special tools from ZCC Cutting Tools?

We develop customised tool solutions for you for a wide range of machining operations. We work closely with you from day one to design tools optimised to meet your needs and priorities. From design and production to logistics, we draw on many years of experience to offer a full range of expert services. Take advantage of our expertise to ensure the long-term success of your company.

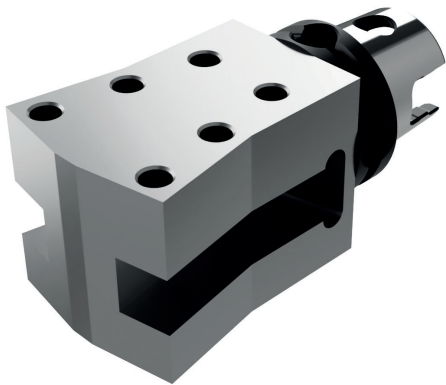

Example: Special tool holder



Example: Special solid carbide step drill

The easy way to order your custom-made special tool

Are there specific applications at your company where having custom tools tailored to your unique needs would deliver real benefits both in terms of logistics and at a technical and commercial level? ZCC Cutting Tools is there to advise and assist you during the planning, development and ordering process. Use our new online tool to request a special tool and get your personal quotation in just a few short steps (www.zccct-europe.com).

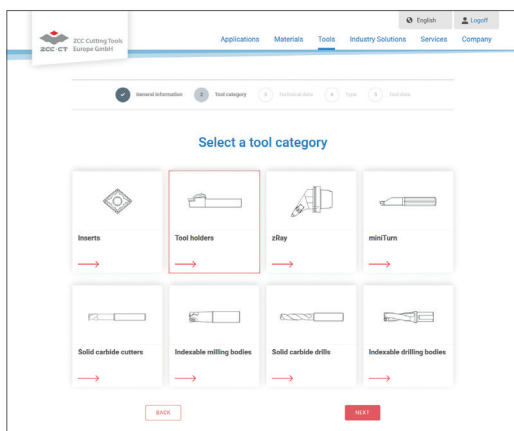

'Online tool for special tools' launch page where you can select the tool category

Selecting the tool category

Scan the QR code on this page to go directly to the launch page of our online tool where you can request the special tool you need. You can begin by selecting the tool category you need. It's that easy.

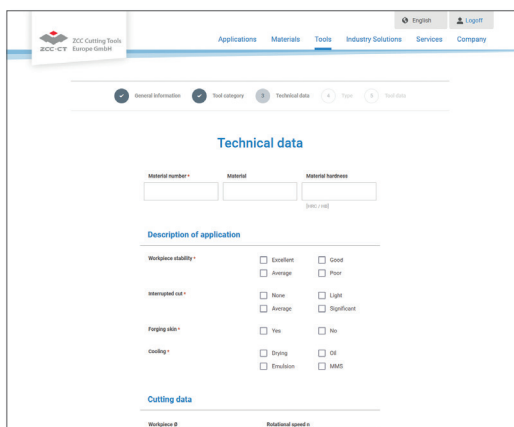

Define the relevant tool parameters

Defining the tool parameters

You are now guided step by step through the process. You can also securely upload your drawings, diagrams and 3D models (where available).

The fast and direct way to order your special tool from ZCC Cutting Tools Europe.



Now go directly to the new **special tool form** on our website and get started.

SOLID CARBIDE THREADING TOOLS

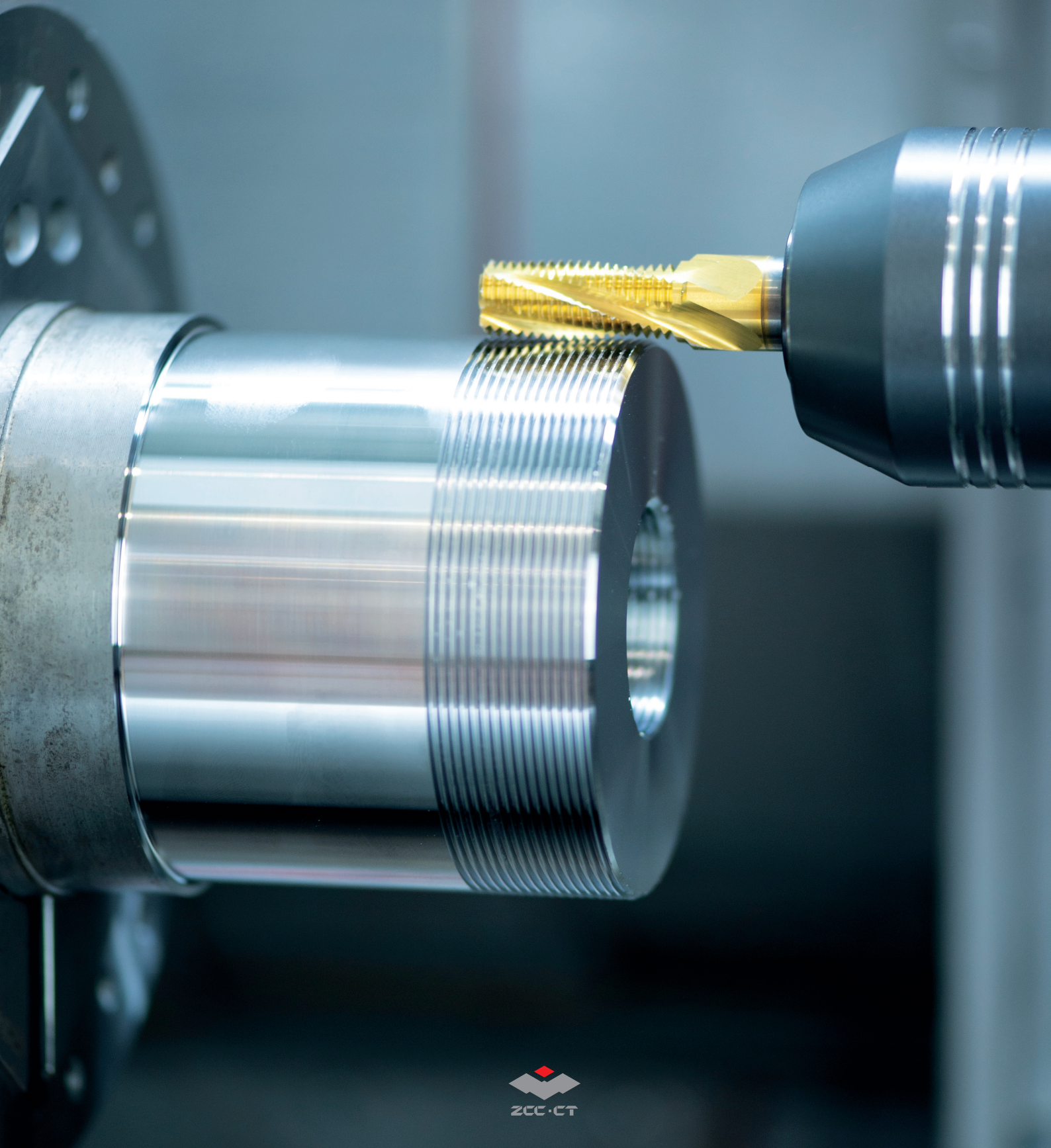

Solid carbide threading tools

Product overview	C174
Grade overview	C175
System code – solid carbide threading tools	C176
Solid carbide thread formers	C177-C182
Solid carbide taps	C183-C190
Solid carbide thread milling cutters	C191
Recommended cutting data	C192-C197
Technical information	C211-C213
Special tools	C198-C199



A

Turning

B

Milling

C

Drilling

D

Technical
Information

E

Index

A

Turning

B

Milling

C









Drilling

D

Technical Information

E

Index

Products	Solid carbide threading tools	Ø	Application						Type	Page
			P	M	K	N	S	H		
4122A		M1-M2.5				✓			Solid carbide thread formers	C177
4222A		M3-M16				✓			Solid carbide thread formers	C178
4122M		M1-M2.5	✓	✓					Solid carbide thread formers	C180
4222M		M3-M16	✓	✓					Solid carbide thread formers	C181
4201C		M3-M16			✓				Solid carbide tap, right-hand twist	C183
4202C		M3-M16			✓				Solid carbide tap, straight flute	C185
4201A		M3-M16				✓			Solid carbide tap, right-hand twist	C187
4202A		M3-M16				✓			Solid carbide tap, straight flute	C189
4111		M3-M20	✓		✓	✓			Solid carbide thread milling cutters	C191

✓ Very suitable ✓ Suitable

Coated cemented carbide PVD

Grade	Grade description
KTG402	PVD coated P20–P30/M20–M30 carbide substrate for steel and stainless steel. Especially for thread forming tools.

KTG4015	PVD coated P20–P30/K20–K30 carbide substrate for steel and cast iron. Especially for thread forming tools.
----------------	--

Uncoated cemented carbide

Grade	Grade description
YK40F	Uncoated K20–K30/N20–N30 carbide substrate for cast iron and non ferrous materials.

A

Turning

B

Milling

C

Drilling

DTechnical
Information**E**

Index

4 2 0 1 A (C) (S) – M5x0.8 – 6H

1 2 3 4 5 6 7 8 9

A

Turning

Type	
Code	Description
4	Threading tool

Shank type	
Code	Description
1	Straight shank
2	Straight shank DIN10
5	Straight shank DIN 6535 HA
9	Conical shank

B

Milling

1

2

Tool type	
Code	Description
0	Tap
1	Thread milling cutter
2	Thread former

Flute	
Code	Description
1	Right-hand twist
2	Straight
3	Left-hand twist

3

4

C

Drilling

Material	
Code	Description
A	Aluminum alloy
C	Cast iron
M	Stainless steel
P	Steel
H	Hardened steel

Coolant supply	
Code	Description
C	Internal

5

6

D

Technical Information

Blind hole	
Code	Description
S	Blind hole

Thread type	
Code	Description
M5x0.8	Standard production tolerance
...	Fine production tolerance

7

8

Precision class	
Code	Description
6H	Nominal diameter x pitch
6HX	Fine production tolerance

9

E

Index

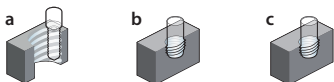

a Thread milling b Thread drilling c Thread forming

Thread former

Non-ferrous metals

4122A



- Factory standard

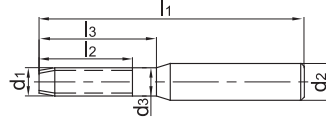

Article	*	Dimensions [mm]								Teeth	Coredrill	Grade
			d ₁	P	d ₂	d ₃	l ₁	l ₂	l ₃		d	YK40F
4122AS-M1*0.25-6H		1.5P	M1	0.25	3	1	40	5	6	3	0.9	○
4122AS-M1.2*0.25-6H		1.5P	M1.2	0.25	3	1.2	40	5	6	3	1.1	○
4122A-M1.6*0.35-6H		3P	M1.6	0.35	3	1.1	40	5	11	3	1.47	●
4122AS-M1.6*0.35-6H		1.5P	M1.6	0.35	3	1.1	40	5	11	3	1.47	●
4122A-M2*0.4-6H		3P	M2	0.4	3	1.5	45	6	12	3	1.85	●
4122AS-M2*0.4-6H		1.5P	M2	0.4	3	1.5	45	6	12	3	1.85	●
4122A-M2.5*0.45-6H		3P	M2.5	0.45	3	1.9	50	6	14	3	2.33	○
4122AS-M2.5*0.45-6H		1.5P	M2.5	0.45	3	1.9	50	6	14	3	2.33	●

● Ex stock ○ On demand

* With internal cooling

Application field

P	M	K	N	S	H
			✓		

✓ Very suitable

✓ Suitable

System code > C176

Machining instructions > C201

Cutting data > C192

Nonstandard order > C198



A

Turning

B

Milling

C

Drilling

D

Technical Information

E

Index

Thread former

Non-ferrous metals

4222A



- Type of shank DIN 10
- Coolant exit, axial concentric

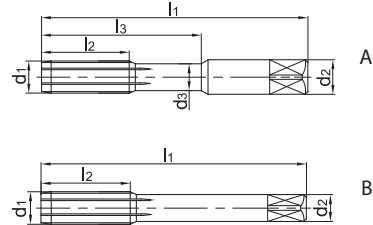

Article	*	Dimensions [mm]									Teeth	Geometry	Coredrill	Grade
			d ₁	P	d ₂	d ₃	l ₁	l ₂	l ₃	d			YK40F	
4222A-M3*0.5-6H		3P	M3	0.5	3.5	2.3	56	6	18	4	A	2.8	○	
4222AS-M3*0.5-6H	*	1.5P	M3	0.5	3.5	2.3	56	6	18	4	A	2.8	●	
4222A-M4*0.5-6H		3P	M4	0.5	4.5	3.1	63	8	21	4	A	3.8	○	
4222AS-M4*0.5-6H	*	1.5P	M4	0.5	4.5	3.1	63	8	21	4	A	3.8	○	
4222A-M4*0.7-6H		3P	M4	0.7	4.5	3.1	63	8	21	4	A	3.7	○	
4222AS-M4*0.7-6H	*	1.5P	M4	0.7	4.5	3.1	63	8	21	4	A	3.7	○	
4222A-M5*0.5-6H		3P	M5	0.5	6	4.3	70	10	25	4	A	4.8	○	
4222AS-M5*0.5-6H	*	1.5P	M5	0.5	6	4.3	70	10	25	4	A	4.8	○	
4222A-M5*0.8-6H		3P	M5	0.8	6	4	70	10	25	4	A	4.65	○	
4222AS-M5*0.8-6H	*	1.5P	M5	0.8	6	4	70	10	25	4	A	4.65	○	
4222A-M6*0.75-6H		3P	M6	0.75	6	5	80	12	30	4	A	5.7	○	
4222AS-M6*0.75-6H	*	1.5P	M6	0.75	6	5	80	12	30	4	A	5.7	○	
4222A-M6*1-6H		3P	M6	1	6	4.7	80	12	30	4	A	5.6	○	
4222AS-M6*1-6H	*	1.5P	M6	1	6	4.7	80	12	30	4	A	5.6	○	
4222A-M7*1.0-6H		3P	M7	1	7	5.7	80	14	30	4	A	6.6	○	
4222AS-M7*1.0-6H	*	1.5P	M7	1	7	5.7	80	14	30	4	A	6.6	○	
4222A-M8*1.0-6H		3P	M8	1	8	6.7	90	16	35	4	A	7.6	○	
4222AS-M8*1-6H	*	1.5P	M8	1	8	6.7	90	16	35	4	A	7.6	○	
4222A-M8*1.25-6H		3P	M8	1.25	8	6.4	90	16	35	4	A	7.45	○	
4222AS-M8*1.25-6H	*	1.5P	M8	1.25	8	6.4	90	16	35	4	A	7.45	○	
4222A-M10*1-6H		3P	M10	1	10	8.7	100	20	39	5	A	9.6	○	
4222AS-M10*1-6H	*	1.5P	M10	1	10	8.7	100	20	39	5	A	9.6	○	
4222A-M10*1.25-6H		3P	M10	1.25	10	8.4	100	20	39	5	A	9.45	○	
4222AS-M10*1.25-6H	*	1.5P	M10	1.25	10	8.4	100	20	39	5	A	9.45	○	
4222A-M10*1.5-6H		3P	M10	1.5	10	8.1	100	20	39	5	A	9.35	○	
4222AC-M10*1.5-6H	*	3P	M10	1.5	10	8.1	100	20	39	5	A	9.35	○	
4222AS-M10*1.5-6H	*	1.5P	M10	1.5	10	8.1	100	20	39	5	A	9.35	○	
4222ACS-M10*1.5-6H	*	1.5P	M10	1.5	10	8.1	100	20	39	5	A	9.35	○	
4222A-M12*1.25-6H		3P	M12	1.25	9		110	24		5	B	11.45	○	
4222AS-M12*1.25-6H	*	1.5P	M12	1.25	9		110	24		5	B	11.45	○	
4222A-M12*1.5-6H		3P	M12	1.5	9		110	24		5	B	11.35	○	
4222AS-M12*1.5-6H	*	1.5P	M12	1.5	9		110	24		5	B	11.35	○	
4222A-M12*1.75-6H		3P	M12	1.75	9		110	24		5	B	11.25	○	

● Ex stock ○ On demand

* With internal cooling

Application field

P	M	K	N	S	H
			✓		

✓ Very suitable

✓ Suitable

System code > C176

Machining instructions > C201

Cutting data > C192

Nonstandard order > C198

Thread former

Non-ferrous metals

4222A



- Type of shank DIN 10
- Coolant exit, axial concentric

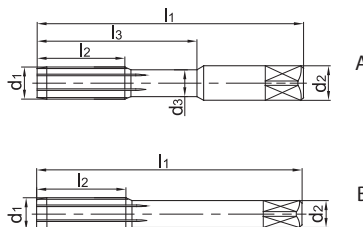

Article	*	Dimensions [mm]								Teeth	Geometry	Coredrill	Grade
		$\frac{d_1}{P}$	d_1	P	d_2	d_3	l_1	l_2	l_3			d	YK40F
4222AC-M12*1.75-6H	*	3P	M12	1.75	9		110	24	5	B	11.25	o	
4222AS-M12*1.75-6H		1.5P	M12	1.75	9		110	24	5	B	11.25	o	
4222ACS-M12*1.75-6H	*	1.5P	M12	1.75	9		110	24	5	B	11.25	o	
4222A-M14*1.5-6H		3P	M14	1.5	11		110	26	6	B	13.35	o	
4222AS-M14*1.5-6H		1.5P	M14	1.5	11		110	26	6	B	13.35	o	
4222A-M14*2-6H		3P	M14	2	11		110	26	6	B	13.1	o	
4222A-M16*1.5-6H		3P	M16	1.5	12		110	27	6	B	15.35	o	
4222AS-M16*1.5-6H		1.5P	M16	1.5	12		110	27	6	B	15.35	o	
4222A-M16*2-6H		3P	M16	2	12		110	27	6	B	15.1	o	
4222AC-M16*2.0-6H	*	3P	M16	2	12		110	27	6	B	15.1	o	
4222AS-M16*2.0-6H		1.5P	M16	2	12		110	27	6	B	15.1	o	
4222ACS-M16*2.0-6H	*	1.5P	M16	2	12		110	27	6	B	15.1	o	

● Ex stock ○ On demand

* With internal cooling

Application field					
P	M	K	N	S	H
			✓		

✓ Very suitable

✓ Suitable

A

Thread former **Steel, stainless steel**

4122M



– Factory standard

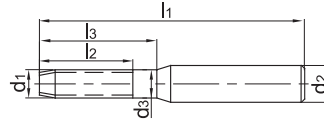

Turning

B

Milling

Article	*	Dimensions [mm]									Teeth	Coredrill		Grade	
			d ₁	P	d ₂	d ₃	l ₁	l ₂	l ₃	d		KTG402	YK40F		
4122M-M1*0.25-6H		3P	M1	0.25	3		40	5	6	4	0.9	●	○		
4122MS-M1*0.25-6H		2P	M1	0.25	3		40	5	6	4	0.9	●	○		
4122M-M1.2*0.25-6H		3P	M1.2	0.25	3		40	5	6	4	1.1	○	○		
4122MS-M1.2*0.25-6H		2P	M1.2	0.25	3		40	5	6	4	1.1	○	○		
4122M-M1.6*0.35-6H		3P	M1.6	0.35	3	1.1	40	5	11	4	1.47	○	○		
4122MS-M1.6*0.35-6H		2P	M1.6	0.35	3	1.1	40	5	11	4	1.47	○	○		
4122M-M2*0.4-6H		3P	M2	0.4	3	1.5	45	6	12	4	1.85	●	○		
4122MS-M2*0.4-6H		2P	M2	0.4	3	1.5	45	6	12	4	1.85	●	○		
4122M-M2.5*0.45-6H		3P	M2.5	0.45	3	1.9	50	6	14	4	2.33	○	○		
4122MS-M2.5*0.45-6H		2P	M2.5	0.45	3	1.9	50	6	14	4	2.33	●	○		

● Ex stock ○ On demand

* With internal cooling

C

Drilling

Application field

P	M	K	N	S	H
✓	✓				

✓ Very suitable

✓ Suitable

D

Technical Information

E

Index

System code > C176

Machining instructions > C201

Cutting data > C192

Nonstandard order > C198

Thread former **Steel, stainless steel**

4222M



- Type of shank DIN 10
- Coolant exit, axial concentric

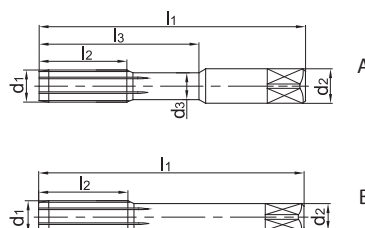

Article	*	Dimensions [mm]									Teeth	Geometry	Coredrill		Grade	
			d ₁	P	d ₂	d ₃	l ₁	l ₂	l ₃	d			KTG402	YK40F		
4222M-M3*0.5-6H		3P	M3	0.5	3.5	2.3	56	6	18	4	A	2.8	●	○		
4222MS-M3*0.5-6H		2P	M3	0.5	3.5	2.3	56	6	18	4	A	2.8	○	○		
4222M-M4*0.5-6H		3P	M4	0.5	4.5	3.1	63	8	21	4	A	3.8	●	○		
4222MS-M4*0.5-6H		2P	M4	0.5	4.5	3.1	63	8	21	4	A	3.8	○	○		
4222M-M4*0.7-6H		3P	M4	0.7	4.5	3.1	63	8	21	4	A	3.7	●	○		
4222MS-M4*0.7-6H		2P	M4	0.7	4.5	3.1	63	8	21	4	A	3.7	●	○		
4222M-M5*0.5-6H		3P	M5	0.5	6	4.3	70	10	25	4	A	4.8	●	○		
4222MS-M5*0.5-6H		2P	M5	0.5	6	4.3	70	10	25	4	A	4.8	●	○		
4222M-M5*0.8-6H		3P	M5	0.8	6	4	70	10	25	4	A	4.65	●	○		
4222MS-M5*0.8-6H		2P	M5	0.8	6	4	70	10	25	4	A	4.65	●	○		
4222M-M6*0.75-6H		3P	M6	0.75	6	5	80	12	30	4	A	5.7	●	○		
4222MS-M6*0.75-6H		2P	M6	0.75	6	5	80	12	30	4	A	5.7	●	○		
4222M-M6*1.0-6H		3P	M6	1	6	4.7	80	12	30	4	A	5.6	●	○		
4222MS-M6*1.0-6H		2P	M6	1	6	4.7	80	12	30	4	A	5.6	●	○		
4222M-M7*1.0-6H		3P	M7	1	7	5.7	80	14	30	4	A	6.6	○	○		
4222MS-M7*1.0-6H		2P	M7	1	7	5.7	80	14	30	4	A	6.6	○	○		
4222M-M8*1.0-6H		3P	M8	1	8	6.7	90	16	35	4	A	7.6	●	○		
4222MS-M8*1.0-6H		2P	M8	1	8	6.7	90	16	35	4	A	7.6	○	○		
4222M-M8*1.25-6H		3P	M8	1.25	8	6.4	90	16	35	4	A	7.45	●	○		
4222MS-M8*1.25-6H		2P	M8	1.25	8	6.4	90	16	35	4	A	7.45	●	○		
4222M-M10*1.0-6H		3P	M10	1	10	8.7	100	20	39	5	A	9.6	○	○		
4222MS-M10*1.0-6H		2P	M10	1	10	8.7	100	20	39	5	A	9.6	○	○		
4222M-M10*1.25-6H		3P	M10	1.25	10	8.4	100	20	39	5	A	9.45	○	○		
4222MS-M10*1.25-6H		2P	M10	1.25	10	8.4	100	20	39	5	A	9.45	●	○		
4222M-M10*1.5-6H		3P	M10	1.5	10	8.1	100	20	39	5	A	9.35	●	○		
4222MC-M10*1.5-6H	*	3P	M10	1.5	10	8.1	100	20	39	5	A	9.35	●	○		
4222MS-M10*1.5-6H		2P	M10	1.5	10	8.1	100	20	39	5	A	9.35	●	○		
4222MCS-M10*1.5-6H	*	2P	M10	1.5	10	8.1	100	20	39	5	A	9.35	●	○		
4222M-M12*1.25-6H		3P	M12	1.25	9		110	24		5	B	11.45	●	○		
4222MS-M12*1.25-6H		2P	M12	1.25	9		110	24		5	B	11.45	●	○		
4222M-M12*1.5-6H		3P	M12	1.5	9		110	24		5	B	11.35	○	○		
4222MS-M12*1.5-6H		2P	M12	1.5	9		110	24		5	B	11.35	○	○		
4222M-M12*1.75-6H		3P	M12	1.75	9		110	24		5	B	11.25	○	○		

● Ex stock ○ On demand

* With internal cooling

Application field					
P	M	K	N	S	H
✓	✓				

- ✓ Very suitable
- ✓ Suitable

System code > C176 Machining instructions > C201 Cutting data > C192 Nonstandard order > C198



A

Turning

B

Milling

C

Drilling

D

Technical Information

E

Index

A

Thread former **Steel, stainless steel**

4222M



- Type of shank DIN 10
- Coolant exit, axial concentric

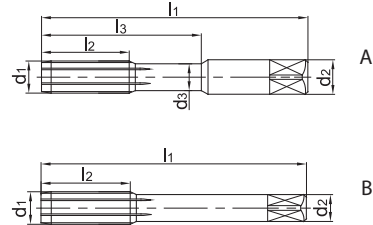

Turning

B

Milling

C

Drilling

Article	*	Dimensions [mm]									Teeth	Geometry	Coredrill		Grade	
		$\frac{f_{cut}}$	d_1	P	d_2	d_3	l_1	l_2	l_3	d			KTG402	YK40F		
4222MC-M12*1.75-6H	*	3P	M12	1.75	9		110	24	5	B	11.25	○	○			
4222MS-M12*1.75-6H		2P	M12	1.75	9		110	24	5	B	11.25	●	○			
4222MCS-M12*1.75-6H	*	2P	M12	1.75	9		110	24	5	B	11.25	○	○			
4222M-M14*1.5-6H		3P	M14	1.5	11		110	26	6	B	13.35	●	○			
4222MS-M14*1.5-6H		2P	M14	1.5	11		110	26	6	B	13.35	○	○			
4222M-M14*2.0-6H		3P	M14	2	11		110	26	6	B	13.1	○	○			
4222MS-M14*2.0-6H		2P	M14	2	11		110	26	6	B	13.1	○	○			
4222M-M16*1.5-6H		3P	M16	1.5	12		110	27	6	B	15.35	●	○			
4222MS-M16*1.5-6H		2P	M16	1.5	12		110	27	6	B	15.35	○	○			
4222M-M16*2.0-6H		3P	M16	2	12		110	27	6	B	15.1	○	○			
4222MC-M16*2.0-6H	*	3P	M16	2	12		110	27	6	B	15.1	○	○			
4222MS-M16*2.0-6H		2P	M16	2	12		110	27	6	B	15.1	○	○			
4222MCS-M16*2.0-6H	*	2P	M16	2	12		110	27	6	B	15.1	●	○			

● Ex stock ○ On demand

* With internal cooling

D

Technical Information

E

Index

Application field

P	M	K	N	S	H
✓	✓				

✓ Very suitable

✓ Suitable

System code > C176

Machining instructions > C201

Cutting data > C192

Nonstandard order > C198

Tap, right-hand twist

Cast iron

4201C



- Type of shank DIN 10
- Coolant exit, axial concentric

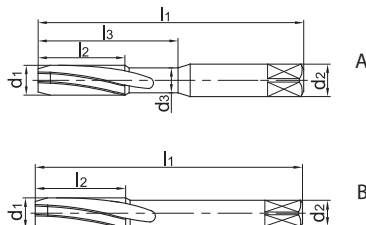

Article	*	Dimensions [mm]									Teeth	Geometry	Coredrill d	Grade YK40F
		$\frac{d_1}{P}$	d_1	P	d_2	d_3	l_1	l_2	l_3					
4201C-M3*0.5-6H		3P	M3	0.5	3.5	2.3	56	11	18	3	A	2.5	●	
4201C-M3*0.5-6HX		3P	M3	0.5	3.5	2.3	56	11	18	3	A	2.5	●	
4201CS-M3*0.5-6H		1.5P	M3	0.5	3.5	2.3	56	11	18	3	A	2.5	●	
4201CS-M3*0.5-6HX		1.5P	M3	0.5	3.5	2.3	56	11	18	3	A	2.5	●	
4201C-M4*0.7-6H		3P	M4	0.7	4.5	3.1	63	13	21	3	A	3.3	●	
4201C-M4*0.7-6HX		3P	M4	0.7	4.5	3.1	63	13	21	3	A	3.3	●	
4201CS-M4*0.7-6H		1.5P	M4	0.7	4.5	3.1	63	13	21	3	A	3.3	●	
4201CS-M4*0.7-6HX		1.5P	M4	0.7	4.5	3.1	63	13	21	3	A	3.3	●	
4201C-M5*0.8-6H		3P	M5	0.8	6	4	70	16	25	3	A	4.2	●	
4201C-M5*0.8-6HX		3P	M5	0.8	6	4	70	16	25	3	A	4.2	●	
4201CS-M5*0.8-6H		1.5P	M5	0.8	6	4	70	16	25	3	A	4.2	●	
4201CS-M5*0.8-6HX		1.5P	M5	0.8	6	4	70	16	25	3	A	4.2	●	
4201C-M6*0.75-6H		3P	M6	0.75	6	5	80	19	30	3	A	5.25	●	
4201C-M6*0.75-6HX		3P	M6	0.75	6	5	80	19	30	3	A	5.25	●	
4201CS-M6*0.75-6H		1.5P	M6	0.75	6	5	80	19	30	3	A	5.25	●	
4201CS-M6*0.75-6HX		1.5P	M6	0.75	6	5	80	19	30	3	A	5.25	●	
4201C-M6*1-6H		3P	M6	1	6	4.7	80	19	30	3	A	5	○	
4201CC-M6*1-6H	*	3P	M6	1	6	4.7	80	19	30	3	A	5	○	
4201C-M6*1-6HX		3P	M6	1	6	4.7	80	19	30	3	A	5	○	
4201CS-M6*1.0-6H		1.5P	M6	1	6	4.7	80	19	30	3	A	5	●	
4201CCS-M6*1-6H	*	1.5P	M6	1	6	4.7	80	19	30	3	A	5	●	
4201CS-M6*1.0-6HX		1.5P	M6	1	6	4.7	80	19	30	3	A	5	●	
4201C-M7*1-6H		3P	M7	1	7	5.7	80	19	30	3	A	6	○	
4201CS-M7*1.0-6H		1.5P	M7	1	7	5.7	80	19	30	3	A	6	●	
4201C-M8*1-6H		3P	M8	1	8	6.7	90	20	35	3	A	7	○	
4201CS-M8*1.0-6H		1.5P	M8	1	8	6.7	90	20	35	3	A	7	●	
4201C-M8*1.25-6H		3P	M8	1.25	8	6.4	90	22	35	3	A	6.75	●	
4201CC-M8*1.25-6H	*	3P	M8	1.25	8	6.4	90	22	35	3	A	6.75	●	
4201C-M8*1.25-6HX		3P	M8	1.25	8	6.4	90	22	35	3	A	6.75	●	
4201CS-M8*1.25-6H		1.5P	M8	1.25	8	6.4	90	22	35	3	A	6.75	○	
4201CCS-M8*1.25-6H	*	1.5P	M8	1.25	8	6.4	90	22	35	3	A	6.75	○	
4201CS-M8*1.25-6HX		1.5P	M8	1.25	8	6.4	90	22	35	3	A	6.75	○	
4201C-M10*1-6H		3P	M10	1	10	8.7	100	20	39	4	A	9	○	

● Ex stock ○ On demand

* With internal cooling

Application field

P	M	K	N	S	H
		✓			

✓ Very suitable

✓ Suitable

System code > C176

Machining instructions > C201

Cutting data > C192

Nonstandard order > C198



Tap, right-hand twist

Cast iron

4201C



- Type of shank DIN 10
- Coolant exit, axial concentric

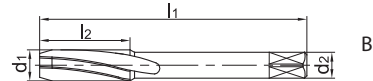
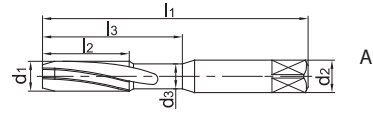

Article	*	Dimensions [mm]									Teeth	Geometry	Coredrill		Grade
			d ₁	P	d ₂	d ₃	l ₁	l ₂	l ₃	d			YK40F		
4201CS-M10*1-6H		1.5P	M10	1	10	8.7	100	20	39	4	A	9	○		
4201C-M10*1.25-6H		3P	M10	1.25	10	8.4	100	24	39	4	A	8.75	○		
4201CS-M10*1.25-6H		1.5P	M10	1.25	10	8.4	100	24	39	4	A	8.75	○		
4201C-M10*1.5-6H		3P	M10	1.5	10	8.1	100	24	39	4	A	8.5	○		
4201CC-M10*1.5-6H	*	3P	M10	1.5	10	8.1	100	24	39	4	A	8.5	○		
4201C-M10*1.5-6HX		3P	M10	1.5	10	8.1	100	24	39	4	A	8.5	○		
4201CS-M10*1.5-6H		1.5P	M10	1.5	10	8.1	100	24	39	4	A	8.5	○		
4201CCS-M10*1.5-6H	*	1.5P	M10	1.5	10	8.1	100	24	39	4	A	8.5	●		
4201CS-M10*1.5-6HX		1.5P	M10	1.5	10	8.1	100	24	39	4	A	8.5	○		
4201C-M12*1.25-6H		3P	M12	1.25	9		110	29		4	B	10.75	○		
4201CS-M12*1.25-6H		1.5P	M12	1.25	9		110	29		4	B	10.75	○		
4201C-M12*1.5-6H		3P	M12	1.5	9		110	29		4	B	10.5	○		
4201CS-M12*1.5-6H		1.5P	M12	1.5	9		110	29		4	B	10.5	○		
4201C-M12*1.75-6H		3P	M12	1.75	9		110	29		4	B	10.25	○		
4201CC-M12*1.75-6H	*	3P	M12	1.75	9		110	29		4	B	10.25	●		
4201C-M12*1.75-6HX		3P	M12	1.75	9		110	29		4	B	10.25	○		
4201CS-M12*1.75-6H		1.5P	M12	1.75	9		110	29		4	B	10.25	○		
4201CCS-M12*1.75-6H	*	1.5P	M12	1.75	9		110	29		4	B	10.25	○		
4201CS-M12*1.75-6HX		1.5P	M12	1.75	9		110	29		4	B	10.25	○		
4201C-M14*1.5-6H		3P	M14	1.5	11		110	30		4	B	12.5	○		
4201CS-M14*1.5-6H		1.5P	M14	1.5	11		110	30		4	B	12.5	○		
4201C-M14*2-6H		3P	M14	2	11		110	30		4	B	12	○		
4201CS-M14*2-6H		1.5P	M14	2	11		110	30		4	B	12	○		
4201C-M16*1.5-6H		3P	M16	1.5	12		110	32		4	B	14.5	○		
4201CS-M16*1.5-6H		1.5P	M16	1.5	12		110	32		4	B	14.5	○		
4201C-M16*2-6H		3P	M16	2	12		110	32		4	B	14	○		
4201CS-M16*2-6H		1.5P	M16	2	12		110	32		4	B	14	○		
4201C-M16*2-6HX		3P	M16	2	12		110	32		4	B	14	○		
4201CS-M16*2-6H		1.5P	M16	2	12		110	32		4	B	14	○		
4201CS-M16*2.0-6HX		1.5P	M16	2	12		110	32		4	B	14	●		

● Ex stock ○ On demand

* With internal cooling

Application field

P	M	K	N	S	H
		✓			

- ✓ Very suitable
- ✓ Suitable

System code > C176

Machining instructions > C201

Cutting data > C192

Nonstandard order > C198

Tap, straight flute

Cast iron

4202C



- Type of shank DIN 10
- Coolant exit, axial concentric

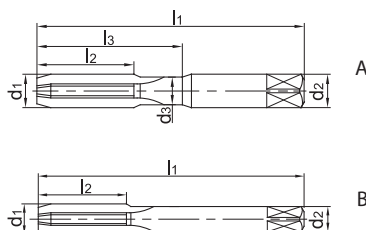

Article	*	Dimensions [mm]									Teeth	Geometry	Coredrill	Grade
		$\frac{f}{z}$	d_1	P	d_2	d_3	l_1	l_2	l_3	d			YK40F	
4202C-M3*0.5-6H		3P	M3	0.5	3.5	2.3	56	11	18	3	A	2.5	○	
4202C-M3*0.5-6HX		3P	M3	0.5	3.5	2.3	56	11	18	3	A	2.5	○	
4202CS-M3*0.5-6H		1.5P	M3	0.5	3.5	2.3	56	11	18	3	A	2.5	○	
4202CS-M3*0.5-6HX		1.5P	M3	0.5	3.5	2.3	56	11	18	3	A	2.5	○	
4202C-M4*0.7-6H		3P	M4	0.7	4.5	3.1	63	13	21	3	A	3.3	●	
4202C-M4*0.7-6HX		3P	M4	0.7	4.5	3.1	63	13	21	3	A	3.3	○	
4202CS-M4*0.7-6H		1.5P	M4	0.7	4.5	3.1	63	13	21	3	A	3.3	○	
4202CS-M4*0.7-6HX		1.5P	M4	0.7	4.5	3.1	63	13	21	3	A	3.3	○	
4202C-M5*0.8-6H		3P	M5	0.8	6	4	70	16	25	3	A	4.2	○	
4202C-M5*0.8-6HX		3P	M5	0.8	6	4	70	16	25	3	A	4.2	○	
4202CS-M5*0.8-6H		1.5P	M5	0.8	6	4	70	16	25	3	A	4.2	○	
4202CS-M5*0.8-6HX		1.5P	M5	0.8	6	4	70	16	25	3	A	4.2	○	
4202C-M6*0.75-6H		3P	M6	0.75	6	5	80	19	30	3	A	5.25	○	
4202C-M6*0.75-6HX		3P	M6	0.75	6	5	80	19	30	3	A	5.25	○	
4202CS-M6*0.75-6H		1.5P	M6	0.75	6	5	80	19	30	3	A	5.25	○	
4202CS-M6*0.75-6HX		1.5P	M6	0.75	6	5	80	19	30	3	A	5.25	○	
4202C-M6*1.0-6H		3P	M6	1	6	4.7	80	19	30	3	A	5	○	
4202CC-M6*1.0-6H	*	3P	M6	1	6	4.7	80	19	30	3	A	5	○	
4202C-M6*1.0-6HX		3P	M6	1	6	4.7	80	19	30	3	A	5	○	
4202CS-M6*1.0-6H		1.5P	M6	1	6	4.7	80	19	30	3	A	5	○	
4202CCS-M6*1.0-6H	*	1.5P	M6	1	6	4.7	80	19	30	3	A	5	○	
4202CS-M6*1.0-6HX		1.5P	M6	1	6	4.7	80	19	30	3	A	5	○	
4202C-M7*1.0-6H		3P	M7	1	7	5.7	80	19	30	3	A	6	○	
4202CS-M7*1.0-6H		1.5P	M7	1	7	5.7	80	19	30	3	A	6	○	
4202C-M8*1-6H		3P	M8	1	8	6.7	90	20	35	3	A	7	○	
4202CS-M8*1.0-6H		1.5P	M8	1	8	6.7	90	20	35	3	A	7	○	
4202C-M8*1.25-6H		3P	M8	1.25	8	6.4	90	22	35	3	A	6.75	○	
4202CC-M8*1.25-6H	*	3P	M8	1.25	8	6.4	90	22	35	3	A	6.75	○	
4202C-M8*1.25-6HX		3P	M8	1.25	8	6.4	90	22	35	3	A	6.75	○	
4202CS-M8*1.25-6H		1.5P	M8	1.25	8	6.4	90	22	35	3	A	6.75	○	
4202CCS-M8*1.25-6H	*	1.5P	M8	1.25	8	6.4	90	22	35	3	A	6.75	○	
4202CS-M8*1.25-6HX		1.5P	M8	1.25	8	6.4	90	22	35	3	A	6.75	○	
4202C-M10*1.0-6H		3P	M10	1	10	8.7	100	20	39	4	A	9	○	

● Ex stock ○ On demand

* With internal cooling

Application field

P	M	K	N	S	H
		✓			

✓ Very suitable

✓ Suitable

System code > C176

Machining instructions > C201

Cutting data > C192

Nonstandard order > C198



Tap, straight flute

Cast iron

4202C



- Type of shank DIN 10
- Coolant exit, axial concentric

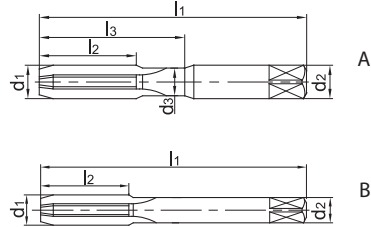

Article	*	Dimensions [mm]									Teeth	Geometry	Coredrill		Grade
			d ₁	P	d ₂	d ₃	l ₁	l ₂	l ₃	d			YK40F		
4202CS-M10*1.0-6H		1.5P	M10	1	10	8.7	100	20	39	4	A	9	o		
4202C-M10*1.25-6H		3P	M10	1.25	10	8.4	100	24	39	4	A	8.75	o		
4202CS-M10*1.25-6H		1.5P	M10	1.25	10	8.4	100	24	39	4	A	8.75	o		
4202C-M10*1.5-6H		3P	M10	1.5	10	8.1	100	24	39	4	A	8.5	o		
4202CC-M10*1.5-6H	*	3P	M10	1.5	10	8.1	100	24	39	4	A	8.5	o		
4202C-M10*1.5-6HX		3P	M10	1.5	10	8.1	100	24	39	4	A	8.5	o		
4202CS-M10*1.5-6H		1.5P	M10	1.5	10	8.1	100	24	39	4	A	8.5	o		
4202CCS-M10*1.5-6H	*	1.5P	M10	1.5	10	8.1	100	24	39	4	A	8.5	o		
4202CS-M10*1.5-6HX		1.5P	M10	1.5	10	8.1	100	24	39	4	A	8.5	o		
4202C-M12*1.25-6H		3P	M12	1.25	9		110	29		4	B	10.75	o		
4202CS-M12*1.25-6H		1.5P	M12	1.25	9		110	29		4	B	10.75	o		
4202C-M12*1.5-6H		3P	M12	1.5	9		110	29		4	B	10.5	o		
4202CS-M12*1.5-6H		1.5P	M12	1.5	9		110	29		4	B	10.5	o		
4202C-M12*1.75-6H		3P	M12	1.75	9		110	29		4	B	10.25	o		
4202CC-M12*1.75-6H	*	3P	M12	1.75	9		110	29		4	B	10.25	o		
4202C-M12*1.75-6HX		3P	M12	1.75	9		110	29		4	B	10.25	o		
4202CS-M12*1.75-6H		1.5P	M12	1.75	9		110	29		4	B	10.25	o		
4202CCS-M12*1.75-6H	*	1.5P	M12	1.75	9		110	29		4	B	10.25	o		
4202CS-M12*1.75-6HX		1.5P	M12	1.75	9		110	29		4	B	10.25	o		
4202C-M14*1.5-6H		3P	M14	1.5	11		110	30		4	B	12.5	o		
4202CS-M14*1.5-6H		1.5P	M14	1.5	11		110	30		4	B	12.5	o		
4202C-M14*2.0-6H		3P	M14	2	11		110	30		4	B	12	o		
4202CS-M14*2.0-6H		1.5P	M14	2	11		110	30		4	B	12	o		
4202C-M16*1.5-6H		3P	M16	1.5	12		110	32		4	B	14.5	o		
4202CS-M16*1.5-6H		1.5P	M16	1.5	12		110	32		4	B	14.5	o		
4202C-M16*2-6H		3P	M16	2	12		110	32		4	B	14	o		
4202C-M16*2-6HX		3P	M16	2	12		110	32		4	B	14	o		
4202CS-M16*2-6H		1.5P	M16	2	12		110	32		4	B	14	o		
4202CS-M16*2.0-6HX		1.5P	M16	2	12		110	32		4	B	14	o		

● Ex stock ○ On demand

* With internal cooling

Application field

P	M	K	N	S	H
		✓			

- ✓ Very suitable
- ✓ Suitable

System code > C176

Machining instructions > C201

Cutting data > C192

Nonstandard order > C198

Tap, right-hand twist

Non-ferrous metals

4201A



- Type of shank DIN 10
- Coolant exit, axial concentric

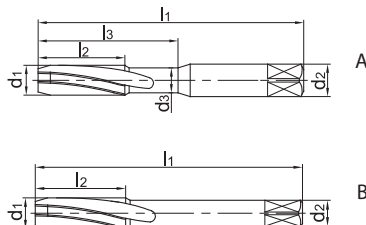

Article	*	Dimensions [mm]									Teeth	Geometry	Coredrill		Grade
		$\frac{d_1}{P}$	d_1	P	d_2	d_3	l_1	l_2	l_3	d			YK40F		
4201A-M3*0.5-6H		3P	M3	0.5	3.5	2.3	56	11	18	3	A	2.5	●		
4201A-M3*0.5-6HX		3P	M3	0.5	3.5	2.3	56	11	18	3	A	2.5	○		
4201AS-M3*0.5-6H		1.5P	M3	0.5	3.5	2.3	56	11	18	3	A	2.5	●		
4201AS-M3*0.5-6HX		1.5P	M3	0.5	3.5	2.3	56	11	18	3	A	2.5	○		
4201A-M4*0.7-6H		3P	M4	0.7	4.5	3.1	63	13	21	3	A	3.3	●		
4201A-M4*0.7-6HX		3P	M4	0.7	4.5	3.1	63	13	21	3	A	3.3	○		
4201AS-M4*0.7-6H		1.5P	M4	0.7	4.5	3.1	63	13	21	3	A	3.3	●		
4201AS-M4*0.7-6HX		1.5P	M4	0.7	4.5	3.1	63	13	21	3	A	3.3	○		
4201A-M5*0.8-6H		3P	M5	0.8	6	4	70	16	25	3	A	4.2	○		
4201A-M5*0.8-6HX		3P	M5	0.8	6	4	70	16	25	3	A	4.2	○		
4201AS-M5*0.8-6H		1.5P	M5	0.8	6	4	70	16	25	3	A	4.2	●		
4201AS-M5*0.8-6HX		1.5P	M5	0.8	6	4	70	16	25	3	A	4.2	○		
4201A-M6*0.75-6H		3P	M6	0.75	6	5	80	19	30	3	A	5.25	○		
4201A-M6*0.75-6HX		3P	M6	0.75	6	5	80	19	30	3	A	5.25	●		
4201AS-M6*0.75-6H		1.5P	M6	0.75	6	5	80	19	30	3	A	5.25	●		
4201AS-M6*0.75-6HX		1.5P	M6	0.75	6	5	80	19	30	3	A	5.25	○		
4201A-M6*1-6H		3P	M6	1	6	4.7	80	19	30	3	A	5	○		
4201AC-M6*1-6H	*	3P	M6	1	6	4.7	80	19	30	3	A	5	○		
4201A-M6*1-6HX		3P	M6	1	6	4.7	80	19	30	3	A	5	○		
4201AS-M6*1-6H		1.5P	M6	1	6	4.7	80	19	30	3	A	5	●		
4201ACS-M6*1-6H	*	1.5P	M6	1	6	4.7	80	19	30	3	A	5	●		
4201AS-M6*1-6HX		1.5P	M6	1	6	4.7	80	19	30	3	A	5	○		
4201A-M7*1-6H		3P	M7	1	7	5.7	80	19	30	3	A	6	○		
4201AS-M7*1-6H		1.5P	M7	1	7	5.7	80	19	30	3	A	6	○		
4201A-M8*1-6H		3P	M8	1	8	6.7	90	20	35	3	A	7	○		
4201AS-M8*1-6H		1.5P	M8	1	8	6.7	90	20	35	3	A	7	●		
4201A-M8*1.25-6H		3P	M8	1.25	8	6.4	90	22	35	3	A	6.75	○		
4201AC-M8*1.25-6H	*	3P	M8	1.25	8	6.4	90	22	35	3	A	6.75	●		
4201A-M8*1.25-6HX		3P	M8	1.25	8	6.4	90	22	35	3	A	6.75	○		
4201AS-M8*1.25-6H		1.5P	M8	1.25	8	6.4	90	22	35	3	A	6.75	●		
4201ACS-M8*1.25-6H	*	1.5P	M8	1.25	8	6.4	90	22	35	3	A	6.75	●		
4201AS-M8*1.25-6HX		1.5P	M8	1.25	8	6.4	90	22	35	3	A	6.75	○		
4201A-M10*1-6H		3P	M10	1	10	8.7	100	20	39	4	A	9	●		

● Ex stock ○ On demand

* With internal cooling

Application field

P	M	K	N	S	H
			✓		

✓ Very suitable

✓ Suitable

System code > C176

Machining instructions > C201

Cutting data > C192

Nonstandard order > C198



Tap, right-hand twist

Non-ferrous metals

4201A



- Type of shank DIN 10
- Coolant exit, axial concentric

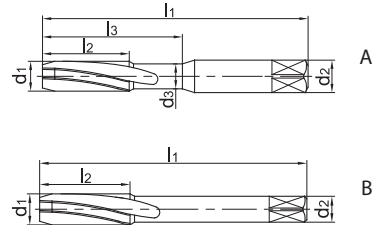

Article	*	Dimensions [mm]									Teeth	Geometry	Coredrill		Grade
			d ₁	P	d ₂	d ₃	l ₁	l ₂	l ₃	d			YK40F		
4201AS-M10*1-6H		1.5P	M10	1	10	8.7	100	20	39	4	A	9	●		
4201A-M10*1.25-6H		3P	M10	1.25	10	8.4	100	24	39	4	A	8.75	○		
4201AS-M10*1.25-6H		1.5P	M10	1.25	10	8.4	100	24	39	4	A	8.75	○		
4201A-M10*1.5-6H		3P	M10	1.5	10	8.1	100	24	39	4	A	8.5	○		
4201AC-M10*1.5-6H	*	3P	M10	1.5	10	8.1	100	24	39	4	A	8.5	●		
4201A-M10*1.5-6HX		3P	M10	1.5	10	8.1	100	24	39	4	A	8.5	○		
4201AS-M10*1.5-6H		1.5P	M10	1.5	10	8.1	100	24	39	4	A	8.5	●		
4201ACS-M10*1.5-6H	*	1.5P	M10	1.5	10	8.1	100	24	39	4	A	8.5	○		
4201AS-M10*1.5-6HX		1.5P	M10	1.5	10	8.1	100	24	39	4	A	8.5	○		
4201A-M12*1.25-6H		3P	M12	1.25	9		110	29		4	B	10.75	○		
4201AS-M12*1.25-6H		1.5P	M12	1.25	9		110	29		4	B	10.75	○		
4201A-M12*1.5-6H		3P	M12	1.5	9		110	29		4	B	10.5	○		
4201AS-M12*1.5-6H		1.5P	M12	1.5	9		110	29		4	B	10.5	○		
4201A-M12*1.75-6H		3P	M12	1.75	9		110	29		4	B	10.25	○		
4201AC-M12*1.75-6H	*	3P	M12	1.75	9		110	29		4	B	10.25	○		
4201A-M12*1.75-6HX		3P	M12	1.75	9		110	29		4	B	10.25	○		
4201AS-M12*1.75-6H		1.5P	M12	1.75	9		110	29		4	B	10.25	●		
4201ACS-M12*1.75-6H	*	1.5P	M12	1.75	9		110	29		4	B	10.25	○		
4201AS-M12*1.75-6HX		1.5P	M12	1.75	9		110	29		4	B	10.25	○		
4201A-M14*1.5-6H		3P	M14	1.5	11		110	30		4	B	12.5	○		
4201AS-M14*1.5-6H		1.5P	M14	1.5	11		110	30		4	B	12.5	○		
4201A-M14*2-6H		3P	M14	2	11		110	30		4	B	12	○		
4201AS-M14*2-6H		1.5P	M14	2	11		110	30		4	B	12	○		
4201A-M16*1.5-6H		3P	M16	1.5	12		110	32		4	B	14.5	○		
4201AS-M16*1.5-6H		1.5P	M16	1.5	12		110	32		4	B	14.5	○		
4201A-M16*2-6H		3P	M16	2	12		110	32		4	B	14	○		
4201AS-M16*2-6H		1.5P	M16	2	12		110	32		4	B	14	○		
4201A-M16*2-6HX		3P	M16	2	12		110	32		4	B	14	○		
4201AS-M16*2-6H		1.5P	M16	2	12		110	32		4	B	14	○		
4201AS-M16*2-6HX		1.5P	M16	2	12		110	32		4	B	14	○		

● Ex stock ○ On demand

* With internal cooling

Application field

P	M	K	N	S	H
			✓		

- ✓ Very suitable
- ✓ Suitable

System code > C176

Machining instructions > C201

Cutting data > C192

Nonstandard order > C198

Tap, straight flute

Non-ferrous metals

4202A



- Type of shank DIN 10
- Coolant exit, axial concentric

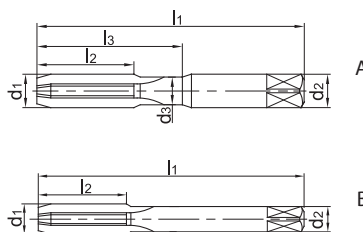

Article	*	Dimensions [mm]									Teeth	Geometry	Coredrill	Grade
		$\frac{d_1}{P}$	d_1	P	d_2	d_3	l_1	l_2	l_3	d			YK40F	
4202A-M3*0.5-6H		3P	M3	0.5	3.5	2.3	56	11	18	3	A	2.5	o	
4202A-M3*0.5-6HX		3P	M3	0.5	3.5	2.3	56	11	18	3	A	2.5	o	
4202AS-M3*0.5-6H		1.5P	M3	0.5	3.5	2.3	56	11	18	3	A	2.5	o	
4202AS-M3*0.5-6HX		1.5P	M3	0.5	3.5	2.3	56	11	18	3	A	2.5	o	
4202A-M4*0.7-6H		3P	M4	0.7	4.5	3.1	63	13	21	3	A	3.3	o	
4202A-M4*0.7-6HX		3P	M4	0.7	4.5	3.1	63	13	21	3	A	3.3	o	
4202AS-M4*0.7-6H		1.5P	M4	0.7	4.5	3.1	63	13	21	3	A	3.3	o	
4202AS-M4*0.7-6HX		1.5P	M4	0.7	4.5	3.1	63	13	21	3	A	3.3	o	
4202A-M5*0.8-6H		3P	M5	0.8	6	4	70	16	25	3	A	4.2	o	
4202A-M5*0.8-6HX		3P	M5	0.8	6	4	70	16	25	3	A	4.2	o	
4202AS-M5*0.8-6H		1.5P	M5	0.8	6	4	70	16	25	3	A	4.2	o	
4202AS-M5*0.8-6HX		1.5P	M5	0.8	6	4	70	16	25	3	A	4.2	o	
4202A-M6*0.75-6H		3P	M6	0.75	6	5	80	19	30	3	A	5.25	o	
4202A-M6*0.75-6HX		3P	M6	0.75	6	5	80	19	30	3	A	5.25	o	
4202AS-M6*0.75-6H		1.5P	M6	0.75	6	5	80	19	30	3	A	5.25	o	
4202AS-M6*0.75-6HX		1.5P	M6	0.75	6	5	80	19	30	3	A	5.25	o	
4202A-M6*1-6H		3P	M6	1	6	4.7	80	19	30	3	A	5	o	
4202AC-M6*1.0-6H	*	3P	M6	1	6	4.7	80	19	30	3	A	5	o	
4202A-M6*1-6HX		3P	M6	1	6	4.7	80	19	30	3	A	5	o	
4202AS-M6*1.0-6H		1.5P	M6	1	6	4.7	80	19	30	3	A	5	o	
4202ACS-M6*1-6H	*	1.5P	M6	1	6	4.7	80	19	30	3	A	5	o	
4202AS-M6*1.0-6HX		1.5P	M6	1	6	4.7	80	19	30	3	A	5	o	
4202A-M7*1-6H		3P	M7	1	7	5.7	80	19	30	3	A	6	o	
4202AS-M7*1.0-6H		1.5P	M7	1	7	5.7	80	19	30	3	A	6	o	
4202A-M8*1-6H		3P	M8	1	8	6.7	90	20	35	3	A	7	o	
4202AS-M8*1.0-6H		1.5P	M8	1	8	6.7	90	20	35	3	A	7	o	
4202A-M8*1.25-6H		3P	M8	1.25	8	6.4	90	22	35	3	A	6.75	o	
4202AC-M8*1.25-6H	*	3P	M8	1.25	8	6.4	90	22	35	3	A	6.75	o	
4202A-M8*1.25-6HX		3P	M8	1.25	8	6.4	90	22	35	3	A	6.75	o	
4202AS-M8*1.25-6H		1.5P	M8	1.25	8	6.4	90	22	35	3	A	6.75	o	
4202ACS-M8*1.25-6H	*	1.5P	M8	1.25	8	6.4	90	22	35	3	A	6.75	o	
4202AS-M8*1.25-6HX		1.5P	M8	1.25	8	6.4	90	22	35	3	A	6.75	o	
4202A-M10*1-6H		3P	M10	1	10	8.7	100	20	39	4	A	9	o	

● Ex stock ○ On demand

* With internal cooling

Application field

P	M	K	N	S	H
			✓		

✓ Very suitable

✓ Suitable

System code > C176

Machining instructions > C201

Cutting data > C192

Nonstandard order > C198



A

Tap, straight flute Non-ferrous metals

4202A



- Type of shank DIN 10
- Coolant exit, axial concentric

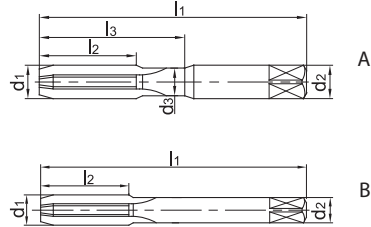

Turning

B

Milling

C

Drilling

D

Technical Information

E

Index

Article	*	Dimensions [mm]									Teeth	Geometry	Coredrill		Grade
			d ₁	P	d ₂	d ₃	l ₁	l ₂	l ₃	d			YK40F		
4202AS-M10*1.0-6H		1.5P	M10	1	10	8.7	100	20	39	4	A	9	○		
4202A-M10*1.25-6H		3P	M10	1.25	10	8.4	100	24	39	4	A	8.75	○		
4202AS-M10*1.25-6H		1.5P	M10	1.25	10	8.4	100	24	39	4	A	8.75	○		
4202A-M10*1.5-6H		3P	M10	1.5	10	8.1	100	24	39	4	A	8.5	○		
4202AC-M10*1.5-6H	*	3P	M10	1.5	10	8.1	100	24	39	4	A	8.5	○		
4202A-M10*1.5-6HX		3P	M10	1.5	10	8.1	100	24	39	4	A	8.5	○		
4202AS-M10*1.5-6H		1.5P	M10	1.5	10	8.1	100	24	39	4	A	8.5	○		
4202ACS-M10*1.5-6H	*	1.5P	M10	1.5	10	8.1	100	24	39	4	A	8.5	○		
4202AS-M10*1.5-6HX		1.5P	M10	1.5	10	8.1	100	24	39	4	A	8.5	○		
4202A-M12*1.25-6H		3P	M12	1.25	9		110	29		4	B	10.75	○		
4202AS-M12*1.25-6H		1.5P	M12	1.25	9		110	29		4	B	10.75	○		
4202A-M12*1.5-6H		3P	M12	1.5	9		110	29		4	B	10.5	○		
4202AS-M12*1.5-6H		1.5P	M12	1.5	9		110	29		4	B	10.5	○		
4202A-M12*1.75-6H		3P	M12	1.75	9		110	29		4	B	10.25	○		
4202AC-M12*1.75-6H	*	3P	M12	1.75	9		110	29		4	B	10.25	○		
4202A-M12*1.75-6HX		3P	M12	1.75	9		110	29		4	B	10.25	○		
4202AS-M12*1.75-6H		1.5P	M12	1.75	9		110	29		4	B	10.25	●		
4202ACS-M12*1.75-6H	*	1.5P	M12	1.75	9		110	29		4	B	10.25	○		
4202AS-M12*1.75-6HX		1.5P	M12	1.75	9		110	29		4	B	10.25	○		
4202A-M14*1.5-6H		3P	M14	1.5	11		110	30		4	B	12.5	○		
4202AS-M14*1.5-6H		1.5P	M14	1.5	11		110	30		4	B	12.5	○		
4202A-M14*2-6H		3P	M14	2	11		110	30		4	B	12	○		
4202AS-M14*2.0-6H		1.5P	M14	2	11		110	30		4	B	12	○		
4202A-M16*1.5-6H		3P	M16	1.5	12		110	32		4	B	14.5	○		
4202AS-M16*1.5-6H		1.5P	M16	1.5	12		110	32		4	B	14.5	○		
4202A-M16*2-6H		3P	M16	2	12		110	32		4	B	14	○		
4202AS-M16*2-6HX		3P	M16	2	12		110	32		4	B	14	○		
4202AS-M16*2.0-6H		1.5P	M16	2	12		110	32		4	B	14	○		
4202AS-M16*2.0-6HX		1.5P	M16	2	12		110	32		4	B	14	○		

● Ex stock ○ On demand

* With internal cooling

Application field					
P	M	K	N	S	H
			✓		

- ✓ Very suitable
- ✓ Suitable

System code > C176

Machining instructions > C201

Cutting data > C192

Nonstandard order > C198

Thread milling cutter, coated

Steel, cast iron, non-ferrous metals

4111



– Factory standard

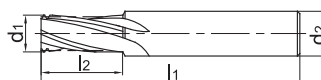

Article	*	Dimensions [mm]						Teeth	Coredrill d	Grade	
		D	d ₁	P	d ₂	l ₁	l ₂			KTG4015	YK40F
4111-M3*0.5		M3	2.35	0.5	4	50	6	3	2.5	●	●
4111-M4*0.7		M4	3.15	0.7	4	50	8	3	3.3	●	○
4111-M5*0.8		M5	4	0.8	6	50	10	3	4.2	●	○
4111-M5*0.5		M5	4.3	0.5	6	50	10	3	4.5	●	○
4111-M6*1		M6	4.75	1	6	60	12	4	5	●	●
4111-M6*0.75		M6	5	0.75	6	60	12	4	5.25	●	○
4111-M8*1.25		M8	6.45	1.25	8	60	16	4	6.75	●	●
4111-M8*1		M8	6.65	1	8	60	16	4	7	●	○
4111-M10*1.5		M10	8.1	1.5	10	75	20	4	8.5	●	○
4111-M10*1		M10	8.55	1	10	75	20	4	9	●	○
4111-M12*1.75		M12	9.75	1.75	12	75	24	4	10.25	●	○
4111-M12*1.25		M12	10.25	1.25	12	75	24	4	10.75	●	○
4111-M14*2		M14	11.4	2	14	75	28	4	12	●	○
4111-M14*1.5		M14	11.9	1.5	14	75	28	4	12.5	●	○
4111-M14*1		M14	12.35	1	14	75	20	4	13	●	○
4111-M16*2		M16	13.3	2	16	90	32	6	14	●	○
4111-M18*2.5		M18	14.75	2.5	18	90	36	6	15.5	●	○
4111-M18*1		M18	16.15	1	18	90	20	6	17	●	○
4111-M20*2.5		M20	16.65	2.5	18	100	40	6	17.5	●	○
4111-M20*2		M20	17.1	2	18	100	40	6	18	●	○

● Ex stock ○ On demand

* With internal cooling

Application field

P	M	K	N	S	H
✓		✓	✓		

✓ Very suitable

✓ Suitable

System code > C176

Machining instructions > C201

Cutting data > C192

Nonstandard order > C198

Guide for recommended cutting data – Solid carbide threading tools

Solid carbide threading tools

	Material group	Composition / structure / heat treatment		Brinell hardness HB	Machining group	Starting values for cutting speed v _c [m/min]							f-group	
						Thread former		Thread former			Thread former			
						4122A 4222A	4122M 4222M	4201C	4201A	4202C	4202A	KTG40115		
						YK40F	YK40F	YK40F	YK40F	YK40F	YK40F			
Coolant:														
external	external	external	external	external	external	external	external	external	external	external				
P	Unalloyed steel	ca. 0,15 % C	annealed	125	1		20					100	1	
		ca. 0,45 % C	annealed	190	2		20					90	1	
		ca. 0,45 % C	tempered	250	3		20					80	1	
		ca. 0,75 % C	annealed	270	4		20					70	1	
	Low-alloyed steel		annealed	180	6		20					90	1	
			tempered	275	7		20					70	1	
			tempered	300	8		20					60	1	
			tempered	350	9		20					55	1	
High-alloyed steel and high-alloyed tool steel		annealed	200	10		20					80	1		
		hardened and tempered	325	11		20					50	1		
M	Stainless steel	ferritic/martensitic	annealed	200	12		20							
		martensitic	tempered	240	13		20							
		austenitic	quench hardened	180	14		20							
		austenitic-ferritic		230	15		20							
K	Grey cast iron	perlite/ferritic		180	16			20		20		80	1	
		perlite (martensitic)		260	17			20		20		60	1	
	Cast iron with spheroidal graphite	ferritic		160	18			15		15		80	1	
		perlite		250	19			15		15		60	1	
	Malleable cast iron	ferritic		130	20			20		20		60	1	
perlite			230	21			20		20		80	1		
N	Aluminium wrought alloys	cannot be hardened		60	22							180	1	
		hardenable	hardened	100	23							150	1	
	Cast aluminium alloys	≤ 12 % Si, cannot be hardened		75	24	30	30		30		30	150	1	
		≤ 12 % Si, hardenable	hardened	90	25	25	25		25		25	150	1	
		> 12 % Si, cannot be hardened		130	26							150	1	
Copper and copper alloys (bronze/brass)	machining steel, PB > 1%			110	27						150	1		
	CuZn, CuSnZn			90	28						150	1		
	CuSn, Pb-free copper, electrolytic copper			100	29						150	1		
S	Heat-resistant alloys	Fe-based alloys	annealed	200	30									
			hardened	280	31									
		Ni or Co base	annealed	250	32									
			hardened	350	33									
		cast	320	34										
Titanium alloys	pure titanium		R _m 400	35										
	α and β alloys	hardened	R _m 1050	36										
H	Hardened steel		hardened and tempered	55 HRC	37									
	Hard cast iron		hardened and tempered	60 HRC	38									
	Hardened cast iron		cast	400	39									
X	Non-metallic materials		hardened and tempered	55 HRC	40									
		Thermoplasts			41									
		Thermosetting plastics			42									
		Plastic, glass-fibre reinforced GFRP			43									
		Plastic, carbon fibre reinforced CFRP			44									
Graphite			45											
Wood			46											

Note: The given cutting values are guide values, which were determined under ideal conditions.

The values have to be adapted in individual cases.

With hole depths of 5xD adjust the cutting data accordingly to the application.

f-group = feed rate recommendations on page C164.

For examples of material for cutting tool groups view page D22.

Recommend feed rate

Solid carbide threading tools

4

f-group	Feed rate [mm]																			
	Ø1	Ø2	Ø3	Ø4	Ø5	Ø6	Ø7	Ø8	Ø9	Ø10	Ø11	Ø12	Ø13	Ø14	Ø15	Ø16	Ø17	Ø18	Ø19	Ø20
1	0,01	0,02	0,03	0,04	0,04	0,05	0,05	0,06	0,06	0,06	0,07	0,07	0,08	0,08	0,09	0,09	0,09	0,09	0,10	0,10
2	0,01	0,02	0,03	0,04	0,05	0,06	0,06	0,06	0,07	0,07	0,08	0,09	0,09	0,10	0,10	0,10	0,10	0,11	0,11	0,11
3	0,01	0,02	0,04	0,05	0,06	0,06	0,07	0,07	0,08	0,09	0,09	0,10	0,10	0,11	0,11	0,12	0,12	0,12	0,13	0,13
4	0,02	0,03	0,04	0,06	0,06	0,07	0,08	0,09	0,09	0,10	0,11	0,11	0,12	0,13	0,14	0,14	0,15	0,15	0,16	0,16
5	0,02	0,03	0,05	0,06	0,07	0,09	0,09	0,10	0,11	0,11	0,12	0,13	0,14	0,15	0,16	0,17	0,17	0,18	0,18	0,19
6	0,02	0,04	0,06	0,07	0,09	0,10	0,11	0,11	0,12	0,13	0,14	0,15	0,16	0,17	0,17	0,18	0,18	0,19	0,19	0,20
7	0,02	0,04	0,06	0,09	0,10	0,11	0,12	0,13	0,14	0,15	0,16	0,17	0,18	0,19	0,20	0,20	0,21	0,22	0,22	0,23
8	0,03	0,05	0,07	0,10	0,11	0,13	0,14	0,15	0,16	0,17	0,18	0,20	0,21	0,22	0,23	0,23	0,24	0,25	0,26	0,26
9	0,03	0,06	0,08	0,11	0,13	0,15	0,16	0,17	0,18	0,20	0,21	0,23	0,24	0,25	0,26	0,27	0,28	0,29	0,29	0,30
10	0,04	0,07	0,10	0,13	0,15	0,17	0,19	0,20	0,21	0,23	0,24	0,26	0,27	0,29	0,30	0,31	0,32	0,33	0,34	0,35
11	0,04	0,07	0,11	0,15	0,17	0,20	0,21	0,23	0,24	0,26	0,28	0,30	0,32	0,33	0,35	0,36	0,37	0,38	0,39	0,40
12	0,05	0,09	0,13	0,17	0,20	0,23	0,25	0,26	0,28	0,30	0,32	0,35	0,36	0,38	0,40	0,41	0,42	0,44	0,45	0,46
13	0,05	0,10	0,15	0,20	0,23	0,26	0,28	0,30	0,32	0,35	0,37	0,40	0,42	0,44	0,46	0,47	0,49	0,50	0,52	0,53
14	0,06	0,11	0,17	0,23	0,26	0,30	0,33	0,35	0,37	0,40	0,43	0,46	0,48	0,50	0,53	0,54	0,56	0,58	0,59	0,61
15	0,07	0,13	0,20	0,26	0,30	0,35	0,37	0,40	0,43	0,46	0,49	0,53	0,55	0,58	0,61	0,62	0,64	0,66	0,68	0,70

Note: The given cutting values are guide values, which were determined under ideal conditions.
The values have to be adapted in individual cases.

1. Select the appropriate product series.
2. Determine the immersion.
3. Select the used material and read the cutting speed.
4. Determine the feed rate group and have a look at the appropriate feed rate recommendations.
5. Select the diameter of tool and determine the immersion.

A

Turning

B

Milling

C

Drilling

D

Technical Information

E

Index

Solid carbide threading tools

	Material group	Composition / structure / heat treatment	Brinell hardness HB	Machining group	Starting values for cutting speed v_c [m/min]									
					Thread former		Thread tap			Thread milling				
					4122A 4222A	4122M 4222M	4201C	4201A	4202C	4202A	4111			
					YK40F	YK40F	YK40F	YK40F	YK40F	YK40F	KTG4015			
Coolant								External	f-group					
External	External	External	External	External	External	External								
P	Unalloyed steel	approx. 0,15 % C	annealed	125	1		20					100	1	
		approx. 0,45 % C	annealed	190	2		20					90	1	
		approx. 0,45 % C	tempered	250	3		20					80	1	
		approx. 0,75 % C	annealed	270	4		20					70	1	
		approx. 0,75 % C	tempered	300	5		20					70	1	
	Low-alloyed steel		annealed	180	6		20					90	1	
			tempered	275	7		20					70	1	
			tempered	300	8		20					60	1	
			tempered	350	9		20					55	1	
		High-alloyed steel and high-alloyed tool steel	annealed	200	10		20					80	1	
	hardened and tempered	325	11		20					50	1			
M	Stainless steel	ferritic/martensitic	annealed	200	12		20							
		martensitic	tempered	240	13		20							
		austenitic	quench hardened	180	14		20							
		austenitic-ferritic		230	15		20							
K	Grey cast iron	perlitic/ferritic		180	16			20		20		80	1	
		perlitic (martensitic)		260	17			20		20		60	1	
	Cast iron with spheroidal graphite	ferritic		160	18			15		15		80	1	
		perlitic		250	19			15		15		60	1	
	Malleable cast iron	ferritic		130	20			20		20		60	1	
		perlitic		230	21			20		20		80	1	
N	Aluminium wrought alloys	cannot be hardened		60	22							180	1	
		hardenable	hardened	100	23							150	1	
	Cast aluminium alloys	$\leq 12\%$ Si, cannot be hardened		75	24	30	30		30		30	150	1	
		$\leq 12\%$ Si, hardenable	hardened	90	25	25	25		25		25	150	1	
		$> 12\%$ Si, cannot be hardened		130	26							150	1	
	Copper and copper alloys (bronze/brass)	machining steel, PB> 1%			110	27						150	1	
		CuZn, CuSnZn			90	28						150	1	
CuSn, Pb-free copper, electrolytic copper			100	29						150	1			
S	Heat-resistant alloys	Fe-based alloys	annealed	200	30									
			hardened	280	31									
		Ni or Co base	annealed	250	32									
			hardened	350	33									
	Titanium alloys	pure titanium		R _m 400	35									
		α and β alloys	hardened		R _m 1050	36								
H	Hardened steel		hardened and tempered	55 HRC	37									
			hardened and tempered	60 HRC	38									
	Hard cast iron		cast	400	39									
	Hardened cast iron		hardened and tempered	55 HRC	40									
X	Non-metallic materials	Thermoplasts			41									
		Thermosetting plastics			42									
		Plastic, glass-fibre reinforced GFRP			43									
		Plastic, carbon fibre reinforced CFRP			44									
		Graphite			45									
		Wood			46									

Note: The given cutting values are guide values, which were determined under ideal conditions.

The values have to be adapted in individual cases.

With hole depths of 5xD adjust the cutting data accordingly to the application.

f-group = feed rate recommendations on page C196.

For examples of material for cutting tool groups view page D11.

Recommended feed rate

Solid carbide threading tools

Groupe f	Feed rate [mm]																			
	Ø1	Ø2	Ø3	Ø4	Ø5	Ø6	Ø7	Ø8	Ø9	Ø10	Ø11	Ø12	Ø13	Ø14	Ø15	Ø16	Ø17	Ø18	Ø19	Ø20
1	0,01	0,02	0,03	0,04	0,04	0,05	0,05	0,06	0,06	0,06	0,07	0,07	0,08	0,08	0,09	0,09	0,09	0,09	0,10	0,10
2	0,01	0,02	0,03	0,04	0,05	0,06	0,06	0,06	0,07	0,07	0,08	0,09	0,09	0,09	0,10	0,10	0,10	0,11	0,11	0,11
3	0,01	0,02	0,04	0,05	0,06	0,06	0,07	0,07	0,08	0,09	0,09	0,10	0,10	0,11	0,11	0,12	0,12	0,12	0,13	0,13
4	0,02	0,03	0,04	0,06	0,06	0,07	0,08	0,09	0,09	0,10	0,11	0,11	0,12	0,12	0,13	0,13	0,14	0,14	0,15	0,15
5	0,02	0,03	0,05	0,06	0,07	0,09	0,09	0,10	0,11	0,11	0,12	0,13	0,14	0,14	0,15	0,15	0,16	0,16	0,17	0,17
6	0,02	0,04	0,06	0,07	0,09	0,10	0,11	0,11	0,12	0,13	0,14	0,15	0,16	0,17	0,17	0,18	0,18	0,19	0,19	0,20
7	0,02	0,04	0,06	0,09	0,10	0,11	0,12	0,13	0,14	0,15	0,16	0,17	0,18	0,19	0,20	0,20	0,21	0,22	0,22	0,23
8	0,03	0,05	0,07	0,10	0,11	0,13	0,14	0,15	0,16	0,17	0,18	0,20	0,21	0,22	0,23	0,23	0,24	0,25	0,26	0,26
9	0,03	0,06	0,08	0,11	0,13	0,15	0,16	0,17	0,18	0,20	0,21	0,23	0,24	0,25	0,26	0,27	0,28	0,29	0,29	0,30
10	0,04	0,07	0,10	0,13	0,15	0,17	0,19	0,20	0,21	0,23	0,24	0,26	0,27	0,29	0,30	0,31	0,32	0,33	0,34	0,35
11	0,04	0,07	0,11	0,15	0,17	0,20	0,21	0,23	0,24	0,26	0,28	0,30	0,32	0,33	0,35	0,36	0,37	0,38	0,39	0,40
12	0,05	0,09	0,13	0,17	0,20	0,23	0,25	0,26	0,28	0,30	0,32	0,35	0,36	0,38	0,40	0,41	0,42	0,44	0,45	0,46
13	0,05	0,10	0,15	0,20	0,23	0,26	0,28	0,30	0,32	0,35	0,37	0,40	0,42	0,44	0,46	0,47	0,49	0,50	0,52	0,53
14	0,06	0,11	0,17	0,23	0,26	0,30	0,33	0,35	0,37	0,40	0,43	0,46	0,48	0,50	0,53	0,54	0,56	0,58	0,59	0,61
15	0,07	0,13	0,20	0,26	0,30	0,35	0,37	0,40	0,43	0,46	0,49	0,53	0,55	0,58	0,61	0,62	0,64	0,66	0,68	0,70

Note: The given cutting values are guide values, which were determined under ideal conditions.
The values have to be adapted in individual cases.

A

Turning

B

Milling

C

Drilling

D

Technical
Information

E

Index

Special tools – fine-tuned to your specific application

Special applications call for special solutions optimised to the task. Special tools are able to deliver real benefits from a commercial, technical or process perspective over standard tool solutions in all industry sectors. We work with you to assess the potential in each individual case, taking into account the general conditions available at your company ZCC Cutting Tools Europe's R&D department then develops a custom solution for you at our EU headquarters in Düsseldorf to keep your machining costs as low as possible.

Why opt for special tools from ZCC Cutting Tools?

We develop customised tool solutions for you for a wide range of machining operations. We work closely with you from day one to design tools optimised to meet your needs and priorities. From design and production to logistics, we draw on many years of experience to offer a full range of expert services. Take advantage of our expertise to ensure the long-term success of your company.

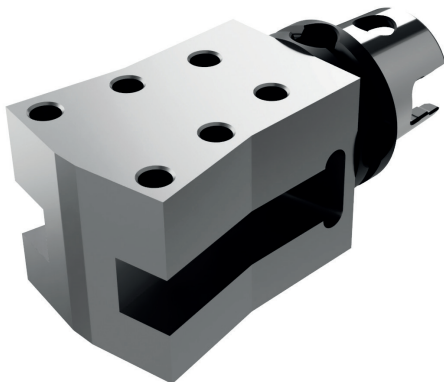

Example: Special tool holder



Example: Special solid carbide step drill

The easy way to order your custom-made special tool

Are there specific applications at your company where having custom tools tailored to your unique needs would deliver real benefits both in terms of logistics and at a technical and commercial level? ZCC Cutting Tools is there to advise and assist you during the planning, development and ordering process. Use our new online tool to request a special tool and get your personal quotation in just a few short steps (www.zccct-europe.com).

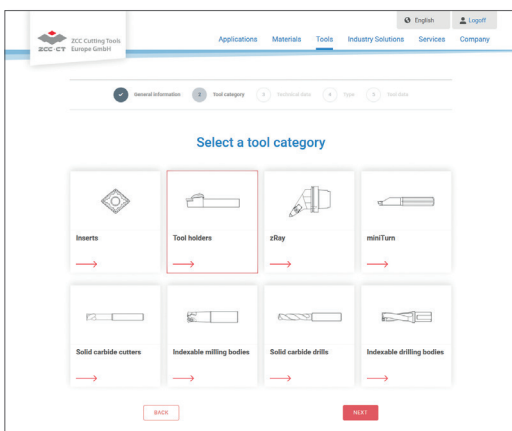

'Online tool for special tools' launch page where you can select the tool category

Selecting the tool category

Scan the QR code on this page to go directly to the launch page of our online tool where you can request the special tool you need. You can begin by selecting the tool category you need. It's that easy.

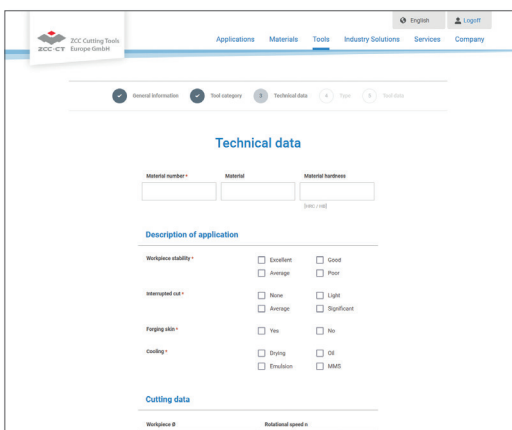

Define the relevant tool parameters

Defining the tool parameters

You are now guided step by step through the process. You can also securely upload your drawings, diagrams and 3D models (where available).

The fast and direct way to order your special tool from ZCC Cutting Tools Europe.



Now go directly to the new **special tool form** on our website and get started.

Technical information

Trouble shooting – drilling

C202-C206

Technical information – drilling

C207-C213

Special tools – drilling

C214

C

A

Turning

B

Milling

C

Drilling

D

Technical
Information

E

Index

Trouble shooting – solid carbide drills

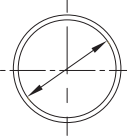
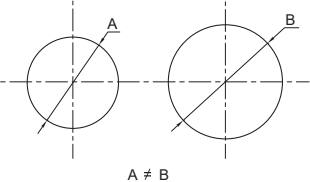
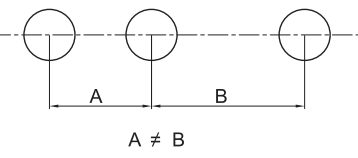
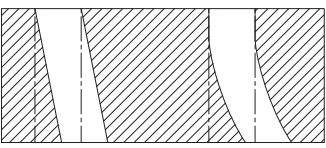
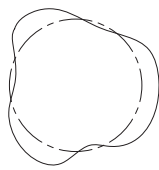
Error	Reason	Countermeasure
Oversized holes 	<ul style="list-style-type: none"> – Insufficient clamping of workpiece and/or tool – Large radial run out – Point relief is off centre 	<ul style="list-style-type: none"> – Use precision clamping – Reduce spindle play – Check and adjust clamped drill
	<ul style="list-style-type: none"> – Asymmetric point angle – Large radial run out – Point relief is off centre 	<ul style="list-style-type: none"> – Regrind drill – Check quality of regrinding
Irregular hole size 	<ul style="list-style-type: none"> – Asymmetric point angle – Large radial run out – Point relief is off centre – High wear 	<ul style="list-style-type: none"> – Use precision clamping – Reduce spindle play – Check and adjust clamped drill
	<ul style="list-style-type: none"> – Insufficient clamping of work piece and/or tool – Large radial run out – Point relief is off centre – High wear 	<ul style="list-style-type: none"> – Use precision clamping – Reduce spindle play – Check and adjust clamped drill
	<ul style="list-style-type: none"> – Feed rate too high 	<ul style="list-style-type: none"> – Reduce feed rate
	<ul style="list-style-type: none"> – Insufficient coolant 	<ul style="list-style-type: none"> – Increase amount of coolant or change coolant supply
Low position accuracy 	<ul style="list-style-type: none"> – Insufficient clamping and spindle positioning – Large radial run out of spindle 	<ul style="list-style-type: none"> – Improve positioning of machine – Use precision clamping – Calibrate spindle – Check and adjust clamped drill
	<ul style="list-style-type: none"> – The feed direction is not vertical to the workpiece surface 	<ul style="list-style-type: none"> – Adjust feed rate vertically to workpiece surface
	<ul style="list-style-type: none"> – Tool isn't aligned with centre of spindle (lathe machines) 	<ul style="list-style-type: none"> – Centre the tool
Bad drill run out 	<ul style="list-style-type: none"> – High tool wear 	<ul style="list-style-type: none"> – Regrind drill
	<ul style="list-style-type: none"> – Poor drill accuracy 	<ul style="list-style-type: none"> – Improve positioning of drill
	<ul style="list-style-type: none"> – Asymmetric point angle – Large radial run out – Point relief is off centre 	<ul style="list-style-type: none"> – Regrind drill – Check quality of regrinding
	<ul style="list-style-type: none"> – Insufficient tool stability 	<ul style="list-style-type: none"> – Improve stability of tool
Inaccurate hole (roundness) 	<ul style="list-style-type: none"> – Asymmetric point angle – Large radial run out – Point relief is off centre – High wear 	<ul style="list-style-type: none"> – Regrind drill – Check quality of regrinding
	<ul style="list-style-type: none"> – Insufficient clamping of work piece and/or tool – Large radial run out of spindle 	<ul style="list-style-type: none"> – Use precision clamping – Calibrate spindle – Check and adjust clamped drill
	<ul style="list-style-type: none"> – Clearance angle too large 	<ul style="list-style-type: none"> – Regrind the drill
	<ul style="list-style-type: none"> – Insufficient tool stability 	<ul style="list-style-type: none"> – Improve tool stability

A

Turning

B

Milling

C

Drilling



D

Technical Information

E

Index

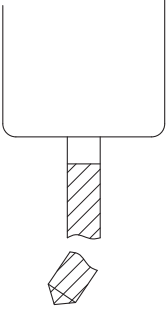
Trouble shooting – solid carbide drills

Error	Reason	Countermeasure
Bad surface quality	– Bad drill regrinding	– Improve regrinding
	– Insufficient amount of coolant or coolant method	– Change coolant supply – Increase amount of coolant
	– Insufficient clamping – Large radial run out of spindle	– Use precision clamping – Calibrate spindle
	– Feed rate too high	– Reduce feed rate
	– High wear of cutting edge – High welding	– Regrind drill – Use a coated drill
	– Bad chip removal	– Chose a suitable drill (with an accordingly flute, helical angle etc.) – Adjust cutting speed (reduce feed rate, etc.)
Bad cylindricity 	– No symmetrical point angle – Large radial run out (drilling) – Centre insert is off centre – Large cutting edge wear – Feed rate too low	– Regrind drill – Check regrind – Increase feed rate
Breakage of drill 	– Insufficient clamping of tool and/or workpiece – Clearance angle too small – Feed rate too high – Excessive wear – Chip jamming – Drilling in uneven surfaces	– Improve stability of tool and clamping of workpiece – Use a drill with bigger clearance angle or regrind – Reduce feed rate – Regrind drill – Chose a suitable drill (considering flute geometry, helical angle, etc.) – Adjust cutting speed – Reduce feed rate – Increase rigidity of drill and clamping of machine and workpiece – Use drill with sharp centre insert – Pre-drill a centre hole – Create a straight surface (e.g. with solid carbide milling cutter) – Use a guide bush or bush plate
Chipping on the drill 	– Hard surface or blow holes – Feed rate too high – Insufficient coolant	– Check material and chose suitable grade – Change cutting conditions (cutting speed, feed rate or machining method) – Reduce feed rate – Improve/increase coolant supply
Chipping on the cutting edge 	– Poor clamping – Large radial run out – Cutting speed and feed rate too high – Clearance angle too large	– Use a more precise clamping device – Adjust the spindle – Reduce cutting speed and feed rate – Use a drill with smaller clearance angle or regrind

A

Turning

B

Milling

C

Drilling

D

Technical Information

E

Index

Trouble shooting – solid carbide drills

Error	Reason	Countermeasure
Excessive wear 	– Overdue regrinding	– Regrind in time
	– Drill tip not in centre position	– Adjust drill with centre of spindle
	– Cutting speed too high	– Reduce cutting speed
	– Cutting angle not suitable	– Chose right cutting angle
	– Material not suitable	– Chose suitable material
	– Insufficient cooling	– Use suitable cooling
Wear and chipping on point relief	– Feed rate too high	– Reduce feed rate
	– Cutting angle not suitable	– Chose right cutting angle
	– Material not suitable	– Chose suitable material
	– Clearance angle too small	– Regrind drill
Breakage on margin	– Guide bush too large	– Change guide bush
Built up edge on margin	– High wear and heat	– Regrind drill
	– Insufficient cooling	– Change cooling method
	– Incorrect coolant	– Change coolant
	– Workpiece material is too soft	– Use drill with smaller clearance angle
High vibrations	– Clearance angle too large	– Regrind drill
	– Drill stability too low	– Improve stability
Swarf clogs the drill	– Long chips – Chip removal not fluent	– Optimise cutting data – Change drill or adjust machine
One-side wear	– Drill tip not centred	– Adjust drill with centre of spindle
	– Poor clamping	– Improve drill clamping – Check concentricity

A

Turning

B

Milling

C

Drilling

D

Technical Information

E

Index

Trouble shooting – PC series

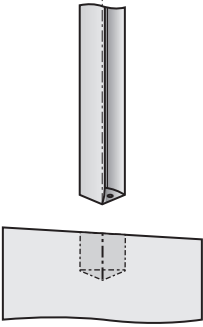
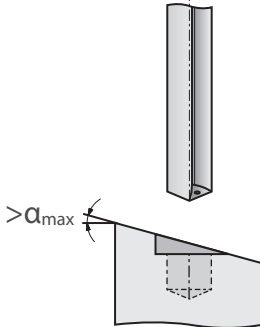
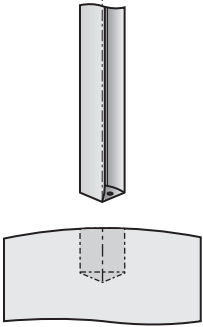
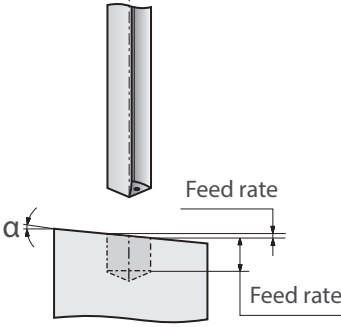
Machining	Recommendation								
<p>Sloped surface</p> 	<p>– Inclined surfaces should be pre-machined (chamfering).</p> 								
<p>Inclined surface</p> 	<p>– Reduce feed rate accordingly.</p>  <table border="1" data-bbox="995 987 1430 1111"> <thead> <tr> <th>Inclination angle</th> <th>Max. feed rate</th> </tr> </thead> <tbody> <tr> <td>1°</td> <td>80%</td> </tr> <tr> <td>2°</td> <td>50%</td> </tr> <tr> <td>3°</td> <td>30%</td> </tr> </tbody> </table>	Inclination angle	Max. feed rate	1°	80%	2°	50%	3°	30%
Inclination angle	Max. feed rate								
1°	80%								
2°	50%								
3°	30%								

A

Turning

B

Milling

C

Drilling

D

Technical Information

E

Index

Trouble shooting – solid carbide reamers

Problem	Solution
Oversized hole	<ul style="list-style-type: none"> – Reduce the diameter of the reamer. – Check concentricity of the reamer and hole. – Check the radial run-out of the reamer. – Check the shank of the reamer for scratches. – Select a suitable coolant. – Adjust the cutting parameters.
Hole too small	<ul style="list-style-type: none"> – Increase the diameter of the reamer. – Reduce the cutting speed. – Reduce allowance. – Regrind or replace the reamer. – Ensure sufficient cooling.
Poor hole roundness and straightness	<ul style="list-style-type: none"> – Guarantee concentricity of the reamer chamfer. – Reduce overhang. – Check radial run-out after the reamer is clamped. – Adjust concentricity of the reamer and hole. – Check and ensure drill geometry.
Poor surface quality	<ul style="list-style-type: none"> – Reduce the cutting speed. – Ensure correct reaming allowance. – Check the cutting chamfer length of the reamer for wear and built-up edge. – Ensure stability of the machine, tool holder and reamer. – Chose the reamer according to the application. – Check the hole allowance.
Poor bore quality	<ul style="list-style-type: none"> – Pull out the reamer in cutting direction. – Reduce the cutting speed. – Use reamers with more teeth. – Check for concentricity and radial run-out. – Improve coolant supply. – Chose the optimal coolant lubrication.
Reamer breakage and thermal damage	<ul style="list-style-type: none"> – The guide chamfer is insufficient. Check the drill and drilling axis. – Adjust machining allowance. – Ensure sufficient coolant supply. – Adjust the cutting speed and feed rate. – Improve the stability of the machine, the tool holder and the cutting tool. – Change or regrind the cutting tool if the cutter wear is too high.
Damage on reamer shank	<ul style="list-style-type: none"> – Check clamping sleeve and tool holder for damage.
Short tool life	<ul style="list-style-type: none"> – Check coolant supply. – Change from straight fluted to helical fluted reamers. – Check all factors affecting machining precision.
Scratched hole surface	<ul style="list-style-type: none"> – Check the cutting edge for built-up edges and if necessary correct the cutting data. – Improve clamping of the work piece.
Trumpet-shaped entry hole	<ul style="list-style-type: none"> – Improve clamping of the work piece. – Check radial run-out of the clamped reamer. – The centre of the reamer may not be aligned with the centre of the hole. Adjust concentricity.

A

Turning

B

Milling

C

Drilling

D

Technical Information

E

Index

Solid carbide drills

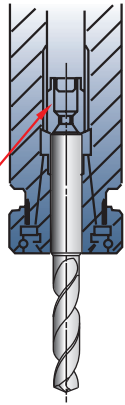
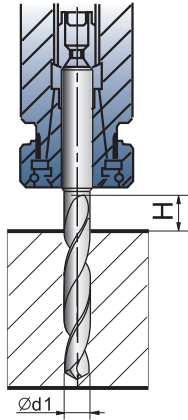
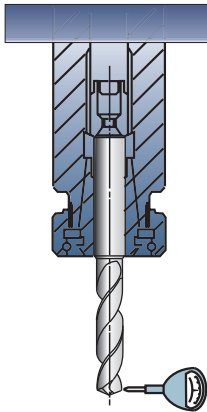
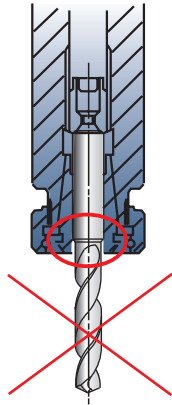

Operation notes

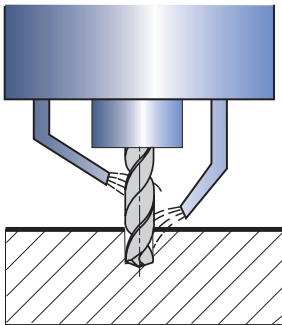
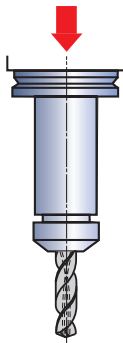
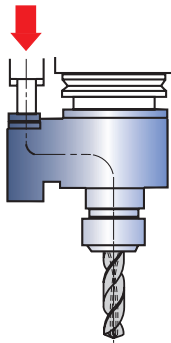
Correct drill clamping	Max. drilling length	Radial run-out	Wrong drill clamping
 <p>Adjusting screw</p> <p>Use precision collets</p>	 <p>$H = 1,5 \times d1$</p>	 <p>Radial run-out $< 0.02 \text{ mm}$</p>	 <p>Don't clamp on the drill flutes.</p>

External coolant method	Internal coolant method	
		
<p>The coolant liquid should shoot to the end and the centre of the drill as shown in the figure.</p>	<p>Coolant pressure is about 0.5–1 mpa (coolant pressure is 2–3 mpa when the diameter is less than 5 mm), coolant volume: 1.5–4 L/min</p>	

Handling of coolants:

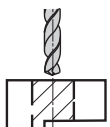
- Small chip particles and dust can cause jamming in the oil hole. A fine mesh filter should be used.
- Dirt and dust particles will adhere to the oil hole and lead to unsmooth coolant flow. Regularly change the coolant. Please ensure proper coolant supply.

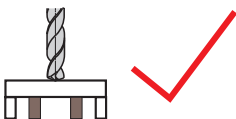
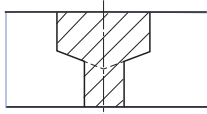
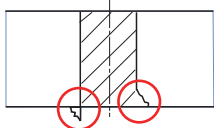
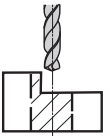
Interrupted cutting	Thin work pieces	Stepped holes	Burrs and work piece chippings on exit
 <p>Reduce the feed rate when drilling interrupted cut.</p>	  <p>If bending occurs, add a supporter.</p>	 <ul style="list-style-type: none"> First drill the larger hole, then the smaller hole. We can offer multiple step and chamfer drills on request. 	 <ul style="list-style-type: none"> Reduce the feed rate approx. by half when the drill exits. Use a drill with a different point angle.
 <p>Machine a countersink with an end mill prior to drilling.</p>			

A

Turning

B

Milling

C

Drilling

D

Technical Information

E

Index

Solid carbide drills

Terminology

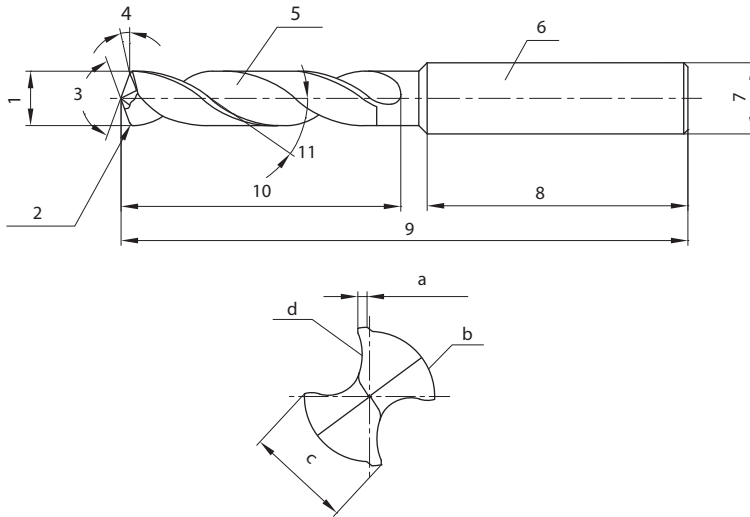

1. Drilling diameter
2. Chamfer
3. Point angle
4. Clearance angle
5. Chip pocket
6. Shank
7. Shank diameter
8. Shank length
9. Overall length
10. Flute length
11. Helical angle

- a. Margin width
- b. Body clearance
- c. Land width
- d. Primary cutting edge

Cutting edge type

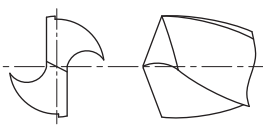
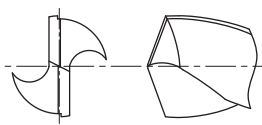
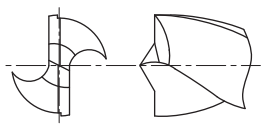
Shape	(Conical)	(Dual flats)	(Centring tip)
			
Features <ul style="list-style-type: none"> - The flank face is conical and the clearance angle increases toward the centre of drill. - Wide applications, commonly used both for soft and hard materials. 	<ul style="list-style-type: none"> - The flank face is dual flats, to facilitate cutting and initial entering. - Often used for small diameter drills. 	<ul style="list-style-type: none"> - This shape has two-stage point angles for perfect centring capabilities and reduces burrs. - It is the first choice for drilling thin plate. 	

A

Turning

B

Milling

C

Drilling

D

Technical Information

E

Index

Solid carbide drills

Drill specification and cutting parameters

Chip pocket	The chip pocket ensures that the chips are removed out of the hole during processing.
Helical angle	The helical angle describes the pitch of the flute. It's specified according to the to be machined material. hardened materials small ← helical angle → large tough materials
Cutting edge length or spiral length	The cutting edge length needs to be specified according to the drilling depth, guide bushing length and the whole regrinding length. The larger the helical angle, the lower the stability. Since it greatly influences the tool life, it should be as small as possible. The recommended min. spiral length is the drilling depth plus 1.5 times of the hole diameter.
Point angle	Generally the point angle is 140°, for special applications it should be set differently. tough materials, easy to machine small ← point angle → large hardened materials and high-performance drilling
Core diameter	The core diameter is an important factor and influences the stability and the chip flow. low axial cutting force low stability for easy to machine materials small ← core diameter → large high axial cutting force high stability for hardened materials or cross holes
Chamfer width	The chamfer width influences the guidance and friction of the drill during machining. low friction and bad drill guidance small ← chamfer width → large high friction and good drill guidance
Back taper	The drill diameter is slightly reduced from cutting edge to shank to reduce friction during machining.
Body clearance	The area behind the chamfer width. The body clearance is necessary to reduce friction during machining.

Deep hole drilling

1 Preparation of the pilot hole with 1534SP03C*

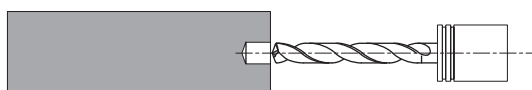

- Point angle of pilot drill must be bigger than SL drill.
- Diameter of pilot drill must be 0.01–0.04 mm bigger than SL drill.
- The pilot hole should be 1–3×D.

2 Entering the pilot hole with SL drill



- Entering the pilot hole with low cutting speed. (VC: 20–30 m/min)
- Stop 1–3 mm before end of pilot hole. (Vf = 0)
- Increase cutting speed up to recommended parameter and then start drilling at feed rate.

3 Manufacturing the deep hole

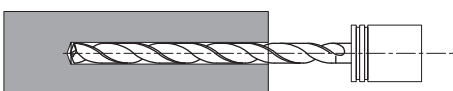

- Drilling with suitable cutting speed and feed rate.
- In case of cross holes feed rate should be reduced to 0.05 mm/rev..

4 Pulling out the drill



- After reaching the required depth reduce the cutting speed (VC: 20–30 m/min) and pull out the drill at high feed rate. (Vf: 2000 mm/min)

A

Turning

B

Milling

C

Drilling

D

Technical Information

E

Index

A

Solid carbide reamers

Terminology

Turning

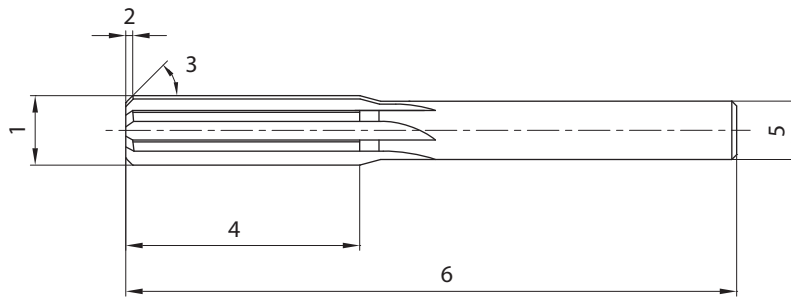

- 1. Nominal diameter
- 2. Chamfer length
- 3. Entry angle
- 4. Cutting edge length
- 5. Shank diameter
- 6. Total length

B

Milling

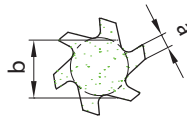

- a. Cutting edge thickness
- b. Core diameter

Reaming is semi-finishing and finishing of a previously formed hole within a narrow tolerance for higher surface quality, perfect roundness, cylindricity, etc. To achieve a precisely reamed hole, the right choice of reamer and reamer diameter is important. In addition to that, the bore tolerance, the material and the machining conditions need to be taken into account. Furthermore the bore quality is strongly influenced by the radial run-out of the cutting tool.

C

Drilling

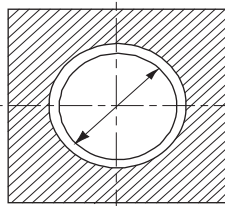

Diameter tolerance/Allowance

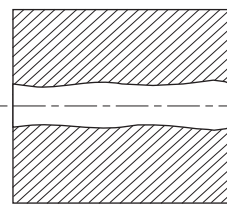

Cylindricity

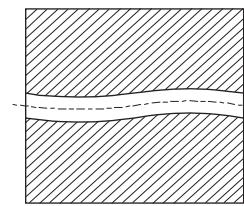

Straightness

D

Technical Information

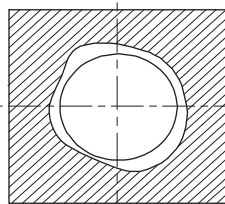

Roundness

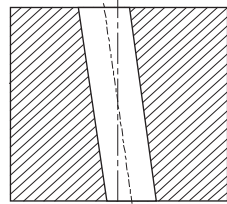

Vertical deviation

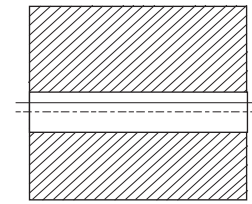

Off centre

E

Index

Solid carbide thread formers

What is thread forming?

The material fibres aren't severed but compressed at the base of the thread. This is why no material is lost unlike when thread cutting.

Advantages of thread forming:

- The thread is formed much more precisely.
- The thread is more resilient.
- The threads have a very smooth surface.
- Higher rotation speeds and feed rates possible than in thread cutting.
- Longer tool life increases the productivity.

Disadvantages of thread forming:

- Higher requirements on the hole tolerance.
- Can't be used as hand tool.
- Greater heat build-up than in thread drilling.
- Limited material choice.
- Often the use of a release agent is necessary.

Thread formers should be used in materials with good cold formability. Next to steel, stainless steel and aluminium alloys, these include light metals and light metal alloys with a yield strength of 1200 N/mm². Basically, all long-chipping materials are suitable.

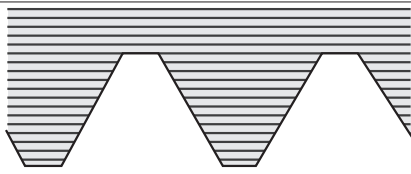

Fibre orientation after thread cutting

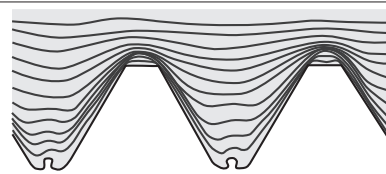

Fibre orientation after thread forming

A

Turning

B

Milling

C

Drilling

D

Technical Information

E

Index

Solid carbide taps

Terminology

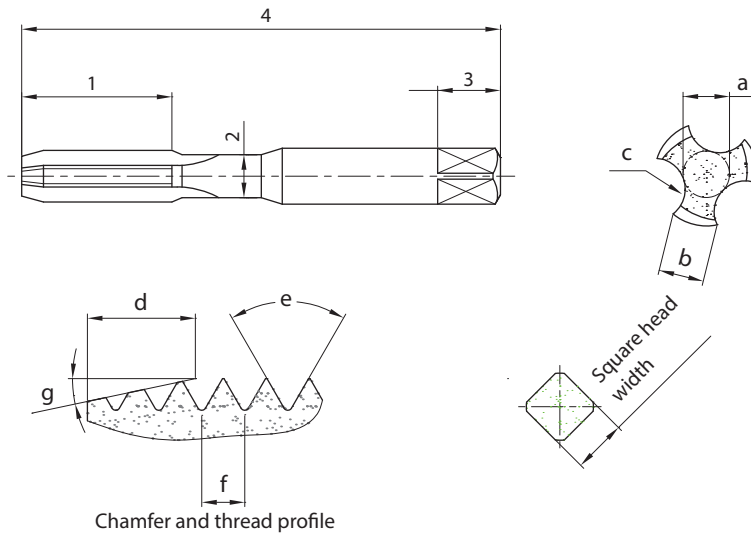



- 1.Thread length
- 2.Neck diameter
- 3.Square head length
- 4.Total length

- a.Core diameter
- b.Cutting edge thickness
- c.Chip pocket

- d.Chamfer length
- e.Thread profile angle
- f.Pitch
- g.Chamfer angle

Chamfer and thread profile

Chip space and application

Chip space type	Features	Application
 <p>Helical flute tap</p>	<ul style="list-style-type: none"> - Helical flute - No chips inside the hole - Good entering performance - Simple centring 	<ul style="list-style-type: none"> - For long-chipping materials - Suitable for blind holes - Usage in holes with groove
 <p>Straight flute tap</p>	<ul style="list-style-type: none"> - Straight flute - Stable cutting edge - Easy regrinding 	<ul style="list-style-type: none"> - For hard machining - For short-chipping materials - For through holes and blind holes - For wear material

Solid carbide thread milling cutters

Solid carbide thread milling cutters with cylindrical shank – example

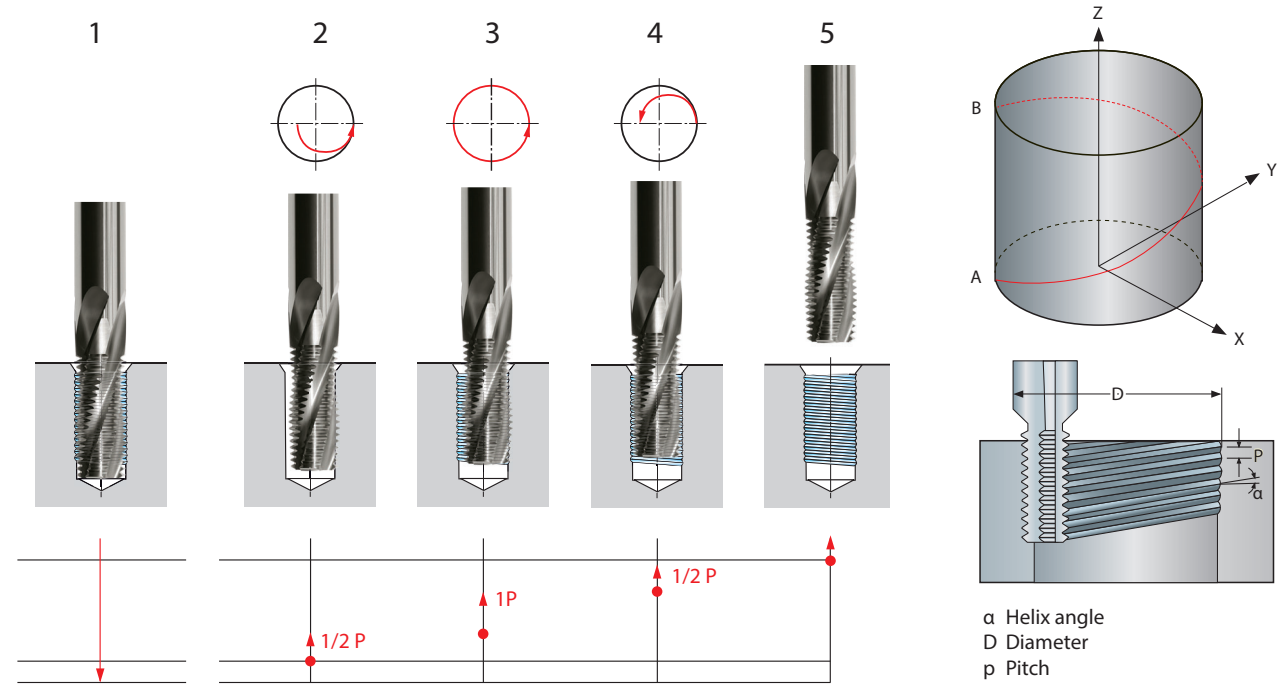

A

Turning

B

Milling

C

Drilling

D

Technical Information

E

Index

Go directly to the special tool tailored for your drilling applications

Are there drilling applications at your company where having custom tools tailored to your unique needs would deliver real benefits both in terms of logistics and at a technical and commercial level? ZCC Cutting Tools Europe is there to advise and assist you during the planning, development and ordering process. Use our new online tool to request a special tool and get your personal quotation in just a few short steps (<https://www.zcct-europe.com/en/tools/special-tools>).

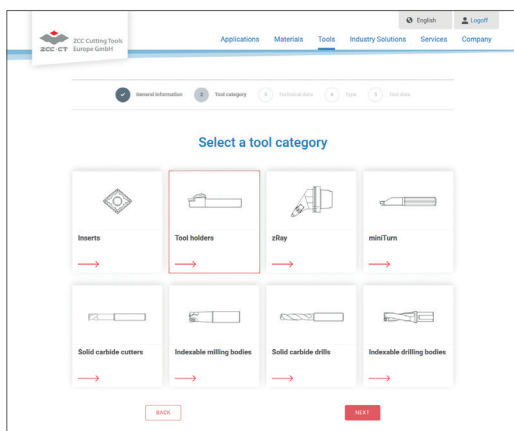

'Online tool for special tools' launch page where you can select the tool category

Selecting the tool category

Scan the QR code on this page to go directly to the launch page of our online tool where you can request the special tool you need. You can begin by selecting the tool category you need. It's that easy.

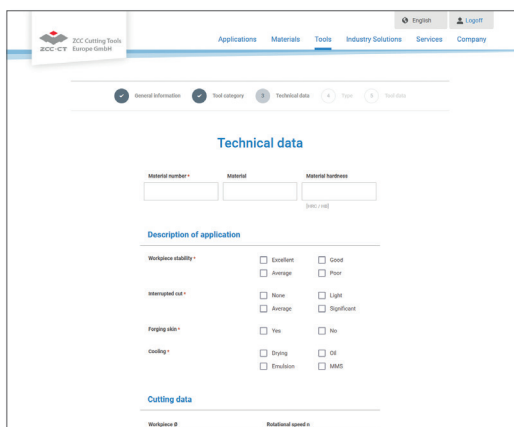

Define the relevant tool parameters.

Defining the tool parameters

You are now guided step by step through the process. You can also securely upload your drawings, diagrams and 3D models (where available).

It's the easy way to order your custom-made special tool from ZCC Cutting Tools Europe GmbH.



Now go directly to the new **special tool form** on our website and get started.

Technical Information

Comparison table materials	D2-D8
Comparison table hardness and tensile strength	D9-D10
Example of materials for machining groups	D11
Torque for screw	D12



A

Turning

B

Milling

C

Drilling

D

Technical
Information

E

Index

Comparison table materials

ISO	Country and standard											
	China	USA	Germany		Great Britain		Sweden	France	Italy	Spain	Japan	Russia
	GB	AISI/SAE	W.-nr	DIN	BS	EN	SS	AFNOR	UNI	UNE	JIS	GOST
P	Alloy steel											
	15	1015	1.0401	C15	080M15	–	1350	CC12	C15C16	F.111	–	–
	20	1020	1.0402	C22	050A20	2C	1450	CC20	C20C21	F.112	–	20
	35	1035	1.0501	C35	060A35	–	1550	CC35	C35	F.113	–	35
	45	1045	1.0503	C45	080M40	–	1650	CC45	C45	F.114	–	45
	55	1055	1.0535	C55	070M55	–	1655	–	C55	–	–	55
	60	1060	1.0601	C60	080A62	43D	–	CC55	C60	–	–	60
	Y15	1213	1.7015	9SMn28	230M07	–	1912	S250	CF9SMn28	11SMn28	SUM22	15Ch
	–	12L13	1.0718	9SMnPb28	–	–	1914	S250Pb	CF9MnPb28	11SMnPb28	SUM22L	–
	–	–	1.0722	10SPb20	–	–	–	10PbF2	CF10Pb20	10SPb20	–	–
	–	1140	1.0726	35S20	212M36	8M	1957	35MF4	–	F210G	–	–
	Y13	1215	1.0736	9SMn36	240M07	1B	–	S300	CF9SMn36	12SMn35	–	–
	–	12L14	1.0737	9SMnPb36	–	–	1926	S300Pb	CF9SMnPb36	12SMnP35	–	–
	55Si2Mn	9255	1.0904	55Si9	250A53	45	2085	55S7	55Si8	56Si7	–	–
	–	9262	1.0961	60SiCr7	–	–	–	60SC7	60SiCr8	60SiCr8	–	–
	15	1015	1.1141	Ck15	080M15	32C	1370	XC12	C16	C15K	S15C	15
	40Mn	1039	1.1157	40Mn4	150M36	15	–	35M5	–	–	–	40G
	25	1025	1.1158	Ck25	–	–	–	–	–	–	S25C	25
	35Mn2	1335	1.1167	36Mn5	–	–	2120	40Mn5	–	36Mn5	SMn438(H)	35G2,35GL
	30Mn	1330	1.1170	28Mn6	150M28	14A	–	20M5	C28Mn	–	SCMn1	30G
	35Mn	1035	1.1183	Cf35	060A35	–	1572	XS38TS	C36	–	S35C	–
	Ck45	1045	1.1191	45	080M46	–	1672	XC42	C45	C45K	S45C	–
	55	1055	1.1203	Ck55	070M55	–	–	XC45	C50	C55K	S55C	55
	50	1050	1.1213	Cf53	060A52	–	1674	XC48TS	C53	–	S50C	–
	60Mn	1060	1.1221	Ck60	080A62	43D	1678	XC60	C60	–	S58C	60,60G
	–	1095	1.1274	Ck101	060A96	–	1870	–	–	–	SUP4	–
	–	–	1.3401	X120Mn12	Z120M12	–	–	X120M12	XG120Mn12	X120Mn12	SCMnH/1	110G13L
	Gr15;45Gr	52100	1.3505	100Cr6	534A99	31	2258	100C6	100Cr6	F.131	SUJ2	SchCh 15
–	ASTM A204Gr.A	1.5415	15Mo3	1501-240	–	2912	15D3	16Mo3KW	16Mo3	–	–	
–	4520	1.5426	16Mo5	1503-245-420	–	–	–	16Mo5	16Mo5	–	–	
–	ASTM A350LF5	1.5622	14Ni6	–	–	–	16N6	14Ni6	15Ni6	–	–	
–	ASTM A353	1.5662	X8Ni9	1501-509;510	–	–	–	X10Ni9	XBNi09	–	–	

Comparison table materials

ISO	Country and standard											
	China	USA	Germany		Great Britain		Sweden	France	Italy	Spain	Japan	Russia
	GB	AISI/SAE	W.-nr	DIN	BS	EN	SS	AFNOR	UNI	UNE	JIS	GOST
P	Alloy steel											
	-	2515	1.5680	12Ni19	-	-	-	Z18N5	-	-	-	-
	-	3135	1.5710	36NiCr6	640A35	111A	-	35NC6	-	-	SNC236	-
	-	3415	1.5732	14NiCr10	-	-	-	14NC11	16NiCr11	15NiCr11	SNC415(H)	-
	-	3415 3310	1.5752	14NiCr14	655M13 655A12	36A	-	12NC15	-	-	SNC815(H)	-
	-	9840	1.6511	36CrNiMo4	816M40	110	-	40NCD3	38CrNiMo4(KB)	35CrNiMo4	-	40 ChN2MA
	-	8620	1.6523	21NiCrMo2	850M20	362	2503	20NCD2	20NiCrMo2	20NiCrMo2	SNCCM220(H)	-
	-	8740	1.6546	40NiCrMo2	311-Type7	-	-	-	40NiCrMo2(KB)	40NiCrMo2	SNC240	38ChGNM
	40CrNiMoA	4340	1.6582	34CrNiMo6	817M40	24	2541	35NCD6	35CrNiMo6(KB)	-	-	38Ch2N2MA
	-	-	1.6587	17CrNiMo6	820A16	-	-	18NCD6	-	14CrNiMo13	-	-
	15Cr	5015	1.7015	15Cr3	523M15	-	-	12C3	-	-	SCr415(H)	15Ch
	35Cr	5132	1.7033	34Cr4	530A32	18B	-	32C4	34Cr4(KB)	35Cr4	SCr430(H)	35Ch
	40Cr	5140	1.7035	41Cr4	530M40	18	-	42C4	41Cr4	42Cr4	SCr440(H)	40Ch
	40Cr	5140	1.7045	42Cr4	-	-	2245	-	-	42Cr4	SCr440	40Ch
	18CrMn	5115	1.7131	16MnCr15	(527M20)	-	2511	16MC5	16MnCr15	16MnCr15	-	18ChG
	20CrMn	5155	1.7176	55Cr3	527A60	48	-	55C3	-	-	SUP9(A)	50ChGA
	30CrMn	4130	1.7218	25CrMo4	1717CDS110	-	2225	25CD4	25CrMo4(KB)	55Cr3	SCM420; SCM430	30ChM
	35CrMo	4137;4135	1.7220	34CrMo4	708A37	19B	2234	35CD4	35CrMo4	34CrMo4	SCM432; SCRMM3	AS38ChGM
	40CrMoA	4140;4142	1.7223	41CrMo4	708M40	19A	2244	42CD4TS	41CrMo4	41CrMo4	SCM440	40 ChFA
	42CrMo 42CrMnMo	4140	1.7225	42CrMo4	708M40	19A	2244	42CD4	42CrMo4	42CrMo4	SCM440(H)	-
	-	-	1.7262	15CrMo5	-	-	2216	12CD4	-	12CrMo4	SCM415(H)	-
	-	ASTM A182 F11;F12	1.7335	13CrMo44	1501- 620Gr.27	-	-	15CD3.5; 15CD4.5	14CrMo44	14CrMo45	-	12ChM, 15ChM
	-	-	1.7361	32CrMo12	722M24	40B	2240	30CD12	32CrMo12	F.124.A	-	-
-	ASTM A182 F.22	1.7380	10CrMo910	1501- 622Gr.31;45	-	2218	12CD9;10	12CrMo9,10	TU.H	-	-	
-	-	1.7715	14MoV63	1503-660-440	-	-	-	-	13MoCrV6	-	-	
50CrVA	6150	1.8159	50CrV4	735A50	47	2230	50CV4	50CrV4	51CrV4	SUP10	50ChGFA	
-	-	1.8509	41CrAlMo7	905M39	41B	2940	40CAD6,12	41CrAlMo7	41CrAlMo7	-	38ChMJuA	
-	-	1.8523	39CrMoV139	897M39	40C	-	-	36CrMoV12	-	-	-	

A

Turning

B

Milling

C

Drilling

D

Technical
Information

E

Index

Comparison table materials

ISO	Country and standard											
	China	USA	Germany		Great Britain		Sweden	France	Italy	Spain	Japan	Russia
	GB	AISI/SAE	W.-nr	DIN	BS	EN	SS	AFNOR	UNI	UNE	JIS	GOST
P	Alloy steel											
	T10	W.110	1.1545	C105W1	-	-	1880	Y1105	C98KU C100KU	F.515 F.516	-	U10A
	T12A	W.112	1.1663	C125W	-	-	-	Y2120	C120KU	(C120)	SK2	U13
	CrV;9SiCr	L3	1.2067	100Cr6	BL3	-	-	Y100C6	-	100Cr6	-	-
	Cr12	D3	1.2080	X210Cr12	BD3	-	-	Z200Cr12	X210Cr13KU X250Cr12KU	X210Cr12	SKD1	Ch12
	4Cr5MoVSi	H13	1.2344	X40CrMoV5 1	BH13	-	2242	Z40CDV5	X35CrMoV05KU X40CrMoV51KU	X40CrMoV5	SKD61	4Ch5MF1S
	Cr6WV	A2	1.2363	X100CrMoV5 1	BA2	-	2260	Z100CDV5	X100CrMoV51KU	X100CrMoV5	SKD12	-
	CrWMo	-	1.2419	105WCr6	-	-	2140	105WC13	10WCr6 107WCr5KU	105WCr5	SKS31 SKS2 SKS3	ChWG
	Cr12W	-	1.2436	X210CrW12	-	-	2312	-	X215CrW12 1KU	X210CrW12	SKD2	-
	5CrNiMo	S1	1.2542	45WCrV7	BS1	-	2710	-	45WCrV8KU	45WCrS18	-	-
	3Cr2W8V	H21	1.2581	X30WCrV9 3 X30WCrV93KU	BH21	-	-	Z30WCV9	X28W09KU X30WCrV9 3KU	X30WCrV9	SKD5	3Ch2W8F
	Cr12MoV	-	1.2601	X165CrMoV 12	-	-	2310	-	X165CrMoW12KU	X160CrMoV12	SKD11	-
	5CrNiMo	L6	1.2713	55NiCrMoV6	-	-	-	55NCDV7	-	F.250.S	SKT4	5ChNM
	V	W210	1.2833	100V1	BW2	-	-	Y1105V	-	-	SKS43	-
	W6Mo5Cr4V2Co5	-	1.3243	S6-5-2-5	-	-	2723	Z85WDKCV	HS6-5-2-5	HS6-5-2-5	SKH55	R6M5K5
	W18Cr4VCo5	T4	1.3255	S18-1-2-5	BT4	-	-	Z80WKC 10-05-04-01	X78WCo1805KU	HS18-1-1-5	SKH3	-
	W6Mo5Cr4V2	M2	1.3343	S6-5-2	BM2	-	2722	Z85WDCV 06-05-04-02	X82WMo0605KU	HS6-5-2	SKH9	R6M5
	-	M7	1.3348	S2-9-2	-	-Z-	2782	Z100WCWV 09-02-04-02	HS2-9-2	HS2-9-2	-	-
	W18Cr4V	T1	1.3355	S18-0-1	BT1	-	-	Z80WCV 18-04-01	X75W18KU	HS18-0-1	SKH2	-
	W6Mo5Cr4V3	M3	-	S6-5-3	-	-	-	-	-	-	SKH52	-
-	M42	-	-	BM42	-	-	-	-	-	SKH59	-	

A

Turning

B

Milling

C

Drilling

D

Technical Information

E

Index

Comparison table materials

ISO	Country and standard						Main application
	China	USA	Germany	Japan	Daido Steel Co., Ltd (Japan)	Russia	
	GB	AISI/SAE	DIN	JIS	DAIDO	GOST	
P	Plastic die steel						
	-	P20 mod.		-	PX5N		For mass production of large mirror dies. Automobile tail light, front fender of car, video camera, household electrical appliances etc
	-	-		-	NAK55		High precision mirror die. Video camera, music disc, Cosmetic Containers, transparent covers, transparent films etc
	-	-		-	NAK80		High precision mirror die. Video camera, music disc, Cosmetic Containers, transparent covers, transparent films etc
	3Cr13	420 mod.		SUS420J2 mod.	S-STAR		For ultra-mirror corrosion resistant precise dies. Accessories of camera, CD, lens, watch case.
	Cold-working die steel						
	-	O2	-	SKS93	YK30		Stamping die, gauge calipers, paper cutter, auxiliary tools
	9CrWMn	O1 mod.	-	SKS3 mod.	GOA		Blanking die, gauge calipers, drawing die, taps, Perforated punch.
	Cr12MoV	D2	X165CrMoV12	SKD11	DC11		Blanking die, cold forming die, cold drawing die, forming roller, punch
	-	D2 mod.	-	SKD11 mod.	DC53		Blanking die, cold forming die, cold drawing die, forming roll, punch
	Hot-working die steel						
	4Cr5MoSiV1	H13	X40CrMoV51	SKD61	DHA1		Aluminum-compression die, connecting parts of compression die, hot stamping die, hot extrusion die, thermal shear cutting blade
	-	-	-	-	DH21		Long life Aluminum compression die
	-	-	-	-	DH31-S		Compression die
	-	-	-	-	DH2F		Compression die, plastic die

A

Turning

B

Milling

C

Drilling

D

Technical Information

E

Index

Comparison table materials

ISO	Country and standard											
	China	USA	Germany		Great Britain		Sweden	France	Italy	Spain	Japan	Russia
	GB	AISI/ SAE	W.-nr	DIN	BS	EN	SS	AFNOR	UNI	UNE	JIS	GOST
M	Stainless steel											
	0Cr13; 1Cr12	403	1.4000	X6Cr13	403S17	-	2301	Z6C13	X6Cr13	F.3110	SUS403	08Ch13
	-	-	1.4001	X7Cr14	-	-	-	-	-	F.8401	-	-
	1Cr13	410	1.4006	X10Cr13	410S21	56A	2302	Z10C14	X12Cr13	F.3401	SUS410	12Ch13
	1Cr17	430	1.4016	X6Cr17	430S15	60	220	Z8C17	X8Cr17	F.3113	SUS430	12Ch17
	2Cr13	410	1.4021	X20Cr13	562	56B; 56C	-	Z20C13	X20C13	F.3401	SUS410	20Ch13
	-	-	1.4027	G-X20Cr14	420C29	56B	-	Z20C13M	-	-	SCS2	20Ch13L
	4Cr13	-	1.4034	X46Cr13	420S45	56D	2304	Z40CM Z38C13M	X40Cr14	F.3405	SUS420J2	40Ch13
	1Cr17Ni2	431	1.4057	X20CrNi172	431S29	57	2321	Z15CNi6.02	X16CNi16	F.3427	SUS431	20Ch17N2
	Y1Cr17	430F	1.4104	X12CrMoS17	-	-	2383	Z10CF17	X10CrS17	F.3117	SUS430F	-
	1Cr17Mo	434	1.4113	X6CrMo171	434S17	-	2325	Z8CD17.01	X8CrMo17	-	SUS434	-
	-	-	1.4313	X5CrNi134	425C11	-	-	Z4CND13.4M	-	-	SCS5	-
	-	-	1.4408	G-X6CrNiMo1810	316C16	-	-	-	-	F.8414	SCS14	07Ch18N10G2S2M2L
	4Cr9Si2	HW3	1.4718	X45CrSi93	401S45	52	-	Z45CS9	X45CrSi8	F.322	SUH1	40Ch9S2
	0Cr13Al	405	1.4724	X10CrAl13	403S17	-	-	Z10C13	X10CrAl12	F.311	SUS405	10Ch13SJu
	Cr17	430	1.4742	X10CrAl18	430S15	60	-	Z10CAS18	X8Cr17	F.3113	SUS430	15Ch18SJu
	8Cr20Si2Ni	HNV6	1.4757	X80CrNiSi20	443S65	59	-	Z80CSN20.02	X80CrSiNi20	F.320V	SUH4	-
	2Cr25N	446	1.4762	X10CrAl24	-	-	2322	Z10CAS24	X16Cr26	-	SUH446	-
	Austenitic stainless steel											
	0Cr18Ni9	304	1.4301	X5CrNi1810	304S15	58E	2332	Z6CN18.09	X5CrNi1810	F.3551; F.3541; F.3504	SUS304	08Ch18N10
	1Cr18Ni9MoZr	303	1.4305	X10CrNiS189	303S21	58M	2346	Z10CNF18.09	X10CrNiS18.09	F.3508	SUS303	-
	0Cr19Ni10	304L	1.4306	X2CrNi1911	304S12	-	2352	Z2CN18.10	X2CrNi18.11	F.3503	SCS19	03Ch18N11
	-	-	1.4308	G-X6CrNi189	304C15	-	-	Z6CN18.10M	-	-	SCS13	07Ch18N9L
	Cr17Ni7	301	1.4310	X12CrNi177	-	-	2331	Z12CN17.07	X12CrNi1707	F.3517	SUS301	-
	-	304LN	1.4311	X2CrNi1810	304S62	-	2371	Z2CN18.10	-	-	SUS304LN	-
	0Cr19Ni9	304	1.4350	X5CrNi189	304S31	58E	-	Z6CN18.09	X5CrNi1810	-	SUS304	-
	0Cr17Ni11Mo2	316	1.4401	X5CrNiMo1712	316S16	Z6CND17.11	2347	1.4401	X5CrNiMo1712	F.3543	SUS316	-
	00Cr17Ni13Mo2	316LN	1.4429	X2CrNiMo17133	-	-	2375	Z2CND17.13	-	-	SUS316LN	-
0Cr27Ni12Mo3	316L	1.4435	X2CrNiMo18143	316S12	-	2353	Z2CDN17.13	X2CrNiMo1713	-	SCS16,	03Ch17N14M2	
00Cr19Ni13Mo3	317L	1.4438	X2CrNiMo17133	317S12	-	2367	Z2CND19.15	X2CrNiMo18.16	-	SUS317L	-	
-	329L	1.4460	X8CrNiMo275	-	-	2324	-	-	-	SUS329L; SCH11; SCS11	-	
1Cr18Ni9Ti	321	1.4541	X6CrNiTi1810	2337	321S12	58B	Z6CNT18.10	X6CrNiTi1811	F.3553	SUS321	12Ch18N10T	
1Cr18Ni11Nb	347	1.4550	X6CrNiNb1810	347S17	58F	2338	Z6CENNb18.1	X6CrNiTi1811	F.3552	SUS347	08Ch18N12B	
Cr18Ni12Mo2Ti	316Ti	1.4571	X6CrNiMoTi17122	320S17	58J	2350	Z6NDT17.12	X6CrNiMoTi17	F.3535	-	10Ch17N13M2T	

Comparison table materials

ISO	Country and standard											
	China	USA	Germany		Great Britain		Sweden	France	Italy	Spain	Japan	Russia
	GB	AISI/SAE	W.-nr	DIN	BS	EN	SS	AFNOR	UNI	UNE	JIS	GOST
M	Austenitic stainless steel											
	-	-	1.4581	G-X5CrNiMoNb1810	318C7	-	-	Z4CNDNb1812M	XG8CrNiMo18	-	SCS22	-
	Cr17Ni12Mo3Nb	318	1.4583	X10CrNiMoNb1812	-	-	-	Z6CNDNb1713B	X6CrNiMoTiNb17	-	-	-
	1Cr23Ni13	309	1.4828	X15CrNiSi2012	309S24	-	-	Z15CNS20.1	-	-	SUH309	20Ch20N14S2
	0Cr25Ni20	310S	1.4845	X12CrNi2521	310S24	-	2361	Z12CN2520	X6CrNi2520	F.331	SUH310	20Ch23N18
	Cr15Ni36W3Ti	330	1.4864	X12NiCrSi3616	-	-	-	Z12CNS35.1	-	-	SUH330	-
	-	-	1.4865	G-X40NiCrSi3818	330C11	-	-	-	XG50NiCr3919	-	SCH15	-
	5Cr2Mn9Ni4N	EV8	1.4871	X53CrMnNiN219	349S54; 321S12	-	58B	-	Z52CMN21.0	X53CrMnNiN219	-	SUH35
1Cr18Ni9Ti	321	1.4878	X12CrNiTi189	321S320	58C	-	Z6CNT18.12	X6CrNiTi1811	F.3523	SU321	09Ch18N10T	

ISO	Country and standard									
	China	USA	Germany	Great Britain	Sweden	France	Italy	Spain	Japan	Russia
K	Nodular cast iron									
	QT400-18	60-40-18	GGG40	400/17	0717-02	FGS370-17	GS370-17	FGE38-17	FCD400	VC 42-12
	QT450-10	65-45-12	---	420/12	---	FGS400-12	GS400-12	FGE42-12	FCD450	-
	QT500-7	70-50-05	GGG50	500/7	0727-02	FGS500-7	GS500-7	FGE50-7	FCD500	VC 50-2
	QT600-3	80-60-03	GGG60	600/7	0732-03	FGS600-2	GS600-2	FGE60-2	FCD600	VC 60-2
	QT700-2	100-70-03	GGG70	700/2	0737-01	FGS700-2	GS700-2	FGE70-2	FCD700	VC 70-2
	QT800-2	120-90-02	GGG80	800/2	0864-03	FGS800-2	GS800-2	FGE80-2	FCD800	VC 80-2
	QT900-2	---	---	900/2	---	---	---	---	---	-
	Nodular cast iron									
	---	NO.60	GG40	---	0140	FGL400	---	---	---	Sc 40
	HT350	NO.50	GG35	350	0135	FGL350	G35	FG35	FC350	Sc 35
	HT300	NO.45	GG30	300	0130	FGL300	G30	FG30	FC300	Sc 30
	HT250	NO.35	GG25	250	0125	FGL250	G25	FG25	FC250	Sc 25
	HT200	NO.30	GG20	200	0120	FGL200	G20	FG20	FC200	Sc 20
	HT150	NO.20	GG15	150	0115	FGL150	G15	FG15	FC150	Sc 15
HT100	---	---	100	0110	---	G10	---	FC100	-	

ISO	Country and standard											
	China	USA	Germany		Great Britain		Sweden	France	Italy	Spain	Japan	Russia
	GB	AISI/SAE	W.-nr	DIN	BS	EN	SS	AFNOR	UNI	UNE	JIS	GOST
H	Hardened materials											
	-	440A	1.4108	X100CrMo03	-	-	2258 08	-	-	-	C4BS	-
	-	610	1.4111	X100CrMoV15	-	-	2534 05	-	-	-	AC4A	-
-	0-2	-	X65CrMo14	-	-	2541 06	-	-	-	AC4A	-	

A

Turning

B

Milling

C

Drilling

D

Technical information

E

Index

Comparison table materials

ISO	Country and standard											
	China	USA	Germany		Great Britain		Sweden	France	Italy	Spain	Japan	Russia
	GB	AISI/SAE	W.-nr	DIN	BS	EN	SS	AFNOR	UNI	UNE	JIS	GOST
N	Aluminium-based alloys											
	-	SC64D	3.2373	G-AISI9MGWA			4251	A-57G			C4BS	-
	-	DG-AISI12		G-ALMG5	LM5		4252	A-SU12			AC4A	
	-	356.1			LM25		4244				A5052	
	-	A413.0		GD-AISI12			4247				A6061	
	-	A380.1		GD-AISI8Cu3	LM24		4250				A7075	
	-	A413.1		G-AISI12(Cu)	LM20		4260				ADC12	
	-	A413.2		G-AISI12	LM6		4261					
-	A360.2		G-AISI10Mg(Cu)	LM9		4253						

ISO	Country and standard											
	China	USA	Germany		Great Britain		Sweden	France	Italy	Spain	Japan	Russia
	GB	AISI/SAE	W.-nr	DIN	BS	EN	SS	AFNOR	UNI	UNE	JIS	GOST
S	Nickel based alloys											
	-	5391	LW2 4670	S-NiCr13A16MoNb	mar-46	-	-	NC12AD	-	-		
	-	AMS 5397	LW2 4674	NiCo15Cr10MoAlTi	-	-	-	-	-	-		
	-	5660	LW2.4662	NiFe35Cr14MoTi	-	-	-	ZSNCDT42	-	-		
	-	5383	LW2.4668	NiCr19Fe19NbMo	HR8	-	-	NC19eNB	-	-		
	-	-	2.4631	NiCr20TiAk	Hr401.601	-	-	NC20TA	-	-		-
	-	AMS 5399	2.4973	NiCr19Co11MoTi	-	-	-	NC19KDT	-	-		-
	-	AMS 5544	LW2.4668	NiCr19Fe19NbMo	-	-	-	NC20K14	-	-		
	-	5390A	2.4603	-	-	-	-	NC22FeD	-	-		-
	-	5666	2.4856	NiCr22Mo9Nb	-	-	-	NC22FeDNB	-	-		-
	-	-	2.4630	NiCr20Ti	HR5.2034	-	-	NC20T	-	-		-
	-	4676	2.4375	NiCu30AL3Ti	3072-76	-	-	-	-	-		-
	Cobalt based alloys											
	-	5537C AMS		CoCr20W15Ni	-	-	-	KC20WN	-	-		
	-	5772	LW2.4964	CoCr20W14Ni				KC22WN				
	Titanium alloys											
	-	UNS R54520	3.7115.1	TiAl5Sn2.5	TA14/17	-	-	T-A5E	-	-		
	-							UNS R56400				
-	-	3.7165.1	TiAl6V4	TA10-13/ TA28		-	UNS R56401	T-A6V	-	-		
-			TiAl5V5Mo5Cr3									
-	-	3.7185	TiAl4Mo4Sn4Si0.5	-	-	-	-	-	-			

A

Turning

B

Milling

C

Drilling

D

Technical Information

E

Index

Comparison table hardness and tensile strength

Hardness				Tensile strength N/mm ²	Hardness				Tensile strength N/mm ²
Rockwell Hardness		Vickers Hardness	Brinell Hardness		Rockwell Hardness		Vickers Hardness	Brinell Hardness	
HRC	HRA	HV	HB		HRC	HRA	HV	HB	
70.0	86.6	1037	—	—	51.0	76.3	525	501	1780
69.5	86.3	1017	—	—	50.5	76.1	517	494	1750
69.0	86.1	997	—	—	50.0	75.8	509	488	1720
68.5	85.8	978	—	—	49.5	75.5	501	481	1690
68.0	85.5	959	—	—	49.0	75.3	493	474	1660
67.5	85.2	941	—	—	48.5	75.0	485	468	1630
67.0	85.0	923	—	—	48.0	74.7	478	461	1605
66.5	84.7	906	—	—	47.5	74.5	470	455	1575
66.0	84.4	889	—	—	47.0	74.2	463	449	1550
65.5	84.1	872	—	—	46.5	73.9	456	442	1525
65.0	83.9	856	—	—	46.0	73.7	449	436	1500
64.5	83.6	840	—	—	45.5	73.4	443	430	1475
64.0	83.3	825	—	—	45.0	73.2	436	424	1450
63.5	83.1	810	—	—	44.5	72.9	429	418	1430
63.0	82.8	795	—	—	44.0	72.6	423	413	1405
62.5	82.5	780	—	—	43.5	72.4	417	407	1385
62.0	82.2	766	—	—	43.0	72.1	411	401	1360
61.5	82.0	752	—	—	42.5	71.8	405	396	1340
61.0	81.7	739	—	—	42.0	71.6	399	391	1320
60.5	81.4	726	—	—	41.5	71.3	393	385	1300
60.0	81.2	713	—	2555	41.0	71.1	388	380	1280
59.5	80.9	700	—	2500	40.0	70.8	382	375	1260
59.0	80.6	688	—	2450	40.0	70.5	377	370	1245
58.5	80.3	676	—	2395	39.5	70.3	372	365	1225
58.0	80.1	664	—	2345	39.0	70.0	367	360	1210
57.5	79.8	653	—	2295	38.5	—	362	355	1190
57.0	79.5	642	—	2250	38.0	—	357	350	1175
56.5	79.3	631	—	2205	37.5	—	352	345	1160
56.0	79.0	620	—	2160	37.0	—	347	341	1140
55.5	78.7	609	—	2115	36.5	—	342	336	1125
55.0	78.5	599	—	2075	36.0	—	338	332	1110
54.5	78.2	589	—	2035	35.5	—	333	327	1095
54.0	77.9	579	—	1995	35.0	—	329	323	1080
53.5	77.7	570	—	1955	34.5	—	324	318	1065
53.0	77.4	561	—	1920	34.0	—	320	314	1050
52.5	77.1	551	—	1885	33.5	—	316	310	1035
52.0	76.9	543	—	1850	33.0	—	312	306	1020
51.5	76.6	534	—	1815	32.5	—	308	302	1010

A

Turning

B

Milling

C

Drilling

D

Technical Information

E

Index

Comparison table hardness and tensile strength

Hardness					Tensile strength N/mm ²	Hardness					Tensile strength N/mm ²
Rockwell Hardness		Vickers Hardness	Brinell Hardness			Rockwell Hardness		Vickers Hardness	Brinell Hardness		
HRC	HRA	HV	HB			HRC	HRA	HV	HB		
32.0	—	304	298		995	24.0	—	249	245		820
31.5	—	300	294		980	23.5	—	246	242		810
31.0	—	296	291		970	23.0	—	243	240		800
30.5	—	292	287		960	22.5	—	240	237		790
30.0	—	289	283		950	22.0	—	237	234		785
29.5	—	285	280		935	21.5	—	234	232		775
29.0	—	281	276		920	21.0	—	231	229		765
28.5	—	278	273		910	20.5	—	229	227		760
28.0	—	274	269		900	20.0	—	226	225		750
27.5	—	271	266		890	19.5	—	223	222		745
27.0	—	268	263		880	19.0	—	221	220		735
26.5	—	264	260		870	18.5	—	218	218		730
26.0	—	261	257		860	18.0	—	216	216		725
25.5	—	258	254		850	17.5	—	214	214		715
25.0	—	255	251		835	17.0	—	211	211		710
24.5	—	252	248		830						

Note: The conversion values for steel in the table are commonly applicable for the steels with carbon from low to high.

A

Turning

B

Milling

C

Drilling

D

Technical Information

E

Index

Examples of materials for machining groups

Material No.	Material	Machining group
1.0722	10SPb20	1
1.0715	9SMn28	1
1.0736	9SMn36	1
1.0718	9SMnPb28	1
1.0737	9SMnPb36	1
1.0401	C15	1
1.0402	C22	1
1.1141	Ck15	1
1.1170	28Mn6	2
1.0726	35S20	2 / 3
1.1167	36Mn5	2 / 3
1.1157	40Mn4	2 / 3
1.0501	C35	2 / 3
1.0503	C45	2 / 3
1.1191	Ck45	2 / 3
1.1183	Cf35	2 / 3
1.1213	Cf53	2 / 3
1.1545	C 105 W1	4 / 5
1.1663	C 125 W	4 / 5
1.0535	C55	4 / 5
1.0601	C60	4 / 5
1.1274	Ck101	4 / 5
1.1203	Ck55	4 / 5
1.1221	Ck60	4 / 5
1.5710	36NiCr6	5 / 9
1.5120	38MnSi 4	5 / 9
1.1545	C 105 W2	4 / 5
1.1663	C 125 W	4 / 5
1.0535	C65	4 / 5
1.0601	C70	4 / 5
1.1274	Ck101	4 / 5
1.1203	Ck55	4 / 5
1.1221	Ck60	4 / 5
1.5710	36NiCr7	5 / 9
1.5120	38MnSi 5	5 / 9
1.1545	C 105 W3	4 / 5
1.1663	C 125 W	4 / 5
1.0535	C75	4 / 5
1.0601	C80	4 / 5
1.1274	Ck101	4 / 5
1.1203	Ck55	4 / 5
1.1221	Ck60	4 / 5
1.5710	36NiCr8	5 / 9
1.5120	38MnSi 6	5 / 9
1.1545	C 105 W4	4 / 5
1.1663	C 125 W	4 / 5
1.0535	C85	4 / 5
1.0601	C90	4 / 5
1.1274	Ck101	4 / 5

Material No.	Material	Machining group
1.1203	Ck55	4 / 5
1.1221	Ck60	4 / 5
1.5710	36NiCr9	5 / 9
1.5120	38MnSi 7	5 / 9
1.1545	C 105 W5	4 / 5
1.1663	C 125 W	4 / 5
1.0535	C95	4 / 5
1.0601	C100	4 / 5
1.1274	Ck101	4 / 5
1.1203	Ck55	4 / 5
1.1221	Ck60	4 / 5
1.5710	36NiCr10	5 / 9
1.5120	38MnSi 8	5 / 9
1.5680	12Ni19	10 / 11
1.3255	S 18-1-2-5	10 / 11
1.3348	S 2-9-2	10 / 11
1.3343	S 6-5-2	10 / 11
1.3243	S 6-5-2-5	10 / 11
1.2363	X 100 CrMoV 5-1	10 / 11
1.2601	X165CrMoV12	10 / 11
1.2080	X210 Cr 12	10 / 11
1.2581	X30WCrV 9-3	10 / 11
1.2344	X40CrMoV 5-1	10 / 11
1.4718	X45CrSi9-3	10 / 11
1.3355	S 18-0-1	10 / 11
1.4027	G-X20Cr14	12 / 13
1.4006	X12 Cr 13	12 / 13
1.4104	X12CrMoS 17	12 / 13
1.4057	X19CrNi 17-2	12 / 13
1.4034	X46Cr 13	12 / 13
1.4871	X53 CrMnNiN 21-9	12 / 13
1.4113	X6CrMo 17	12 / 13
1.4000	X6Cr 13	12 / 13
1.4001	X7Cr14	12 / 13
1.4016	X6Cr17	12 / 13
1.4581	G-X5CrNiMoNb 18	14
1.4308	G-X6CrNi 18-9	14
1.4408	G-X6CrNiMo 18-10	14
1.4583	X6CrNiMoNb 18-12	14
1.4571	X6CrNiMoTi 17-12-2	14
1.4550	X6CrNiNb 18-10	14
1.4541	X14CrNiTi 18-10	14
1.4845	X12CrNi 25-21	14
1.4310	X10CrNi 18-8	14
1.4305	X10CrNiS 18-10	14
1.4878	X12CrNiTi 18-9	14
1.4317	X2CrNi 18-8	14
1.4436	X3CrNiMo 17-13-3	14
1.4440	X2CrNiMo 18-16	14

Material No.	Material	Machining group
1.4429	X2CrNiMoN 17-13-3	14
1.4311	X2CrNiN 18-10	14
1.4301	X5CrNi 18-10	14
1.4401	X5CrNiMo 17-12-2	14
0.6010	GG10	16
0.6015	GG15	16
0.6020	GG20	16
0.6025	GG25	16 / 17
0.6030	GG30	17
0.6035	GG35	17
0.6040	GG40	17
1.4829	X12NiCrSi 22-12	17
1.4828	X15CrNiSi20-12	17
0.7033	GGG35.3	18
0.7040	GGG40	18
0.7043	GGG40.3	18
0.8135	GTS-35	18
0.7050	GGG50	19
0.7060	GGG60	19
0.7070	GGG70	19
0.7660	GGGNiCr 20-2	19
0.7652	GGGNiMn 13-7	19
0.8155	GTS-55	21
0.8165	GTS-65	21
0.8170	GTS-70	21
0.8145	GTS-45	21
3.0205	Al99	22
3.3315	AlMg 1	22
3.1325	AlCuMg 1	23
3.2315	AlMgSi 1	23
3.2581	G-AlSi12	24
3.2163	G-AlSi9Cu3	24
3.2381	G-AlSi10Mg	25
2.0375	CuZn36Pb 3	27
2.1096	G-CuSn5ZnPb	27
2.0590	G-CuZn40Fe	27
2.0240	CuZn15	28
2.0060	E-Cu 57	29
1.4865	G-X40NiCrSi 38-18	30
1.4864	X12NiCrSi 36-16	30
2.4631	NiCr20TiAl	32
2.4856	NiCr22Mo9Nb	32
2.4375	NiCu30Al	33
2.4955	NiFe25Cr20NbTi	33
2.4764	CoCr20W15Ni	34
1.3401	G-X120Mn12	34
3.7165	TiAl6V4	36

A

Turning

B

Milling

C

Drilling

D

Technical
Information

E

Index

Torque for screw

Thread	M1,6	M1,8	M2	M2,2	M2,5	M3	M3,5	M4	M4,5	M5	M6	M7	M8	M10	M12
Torque [Nm]	0,2	0,3	0,4	0,7	0,8	1,5	2,3	3,4	5,0	6,7	11,4	19,2	27,0	55,8	85

A

Turning

B

Milling

C

Drilling

DTechnical
Information**E**

Index

Index

Inserts

E2-E6

Tools

E7-E10

E

A

Turning

B

Milling

C

Drilling

D

Technical
Information

E

Index

A

Turning

B

Milling

C

Drilling

D

Technical Information

E

Index

A

ANGX*PNR-GM	B124 B126 B128 B130 B132
ANGX*PNR-LH	B124 B126 B128 B130 B132
APKT-ALH	B104 B107 B111 B114 B116 B202 B213
APKT-APF	B104 B107 B111 B114 B116 B202 B213
APKT-APM	B104 B107 B111 B114 B116 B202 B213
APKT-LH	B104 B107 B111 B114 B116 B202 B213
APKT-NM	B104 B107 B111 B114 B116 B202 B213

APKT-PF	B104 B107 B111 B114 B116 B202 B213
APKT-PM	B104 B107 B111 B114 B116 B202 B213
APKT-PR	B104 B107 B111 B114 B116 B202 B213
APMT	B118
C	
CCGT (PCD)	A180
CCGT-SF	A116
CCGT-USF	A116
CCGW-1 (PCD)	A182
CCGW-2 (PCBN)	A167
CCGW-L (PCD)	A183
CCGX-LC	A122
CCGX-LH	A122
CCMT-AHF	A117
CCMT-EF	A118
CCMT-EM	A119
CCMT-HF	A117
CCMT-HM	A120
CCMT-HR	A121
CCMT-TC	A121
CCMT-XF	A118
CCMT-XM	A119
CCMW	A121
CNE-A/B	B174
CNEG-NF	A52
CNGA (Ceramic)	A200
CNGA-1 (PCD)	A177
CNGA-2 (PCBN)	A160
CNGA-2W (PCBN)	A160
CNGN (PCBN)	A173
CNGN-M (PCBN)	A173

CNGX (Ceramic)	A203
CNMA	A61
CNMG	A61
CNMG-ADF	A51
CNMG-DF	A51
CNMG-DM	A54
CNMG-DR	A57
CNMG-EF	A51
CNMG-EG	A54
CNMG-EM	A54
CNMG-ER	A58
CNMG-NM	A56
CNMG-PM	A53
CNMG-RF	A114
CNMG-SF	A51
CNMG-SNR	A57
CNMG-TC	A56
CNMG-TK	A56
CNMG-WG	A51
CNMG-XF	A52
CNMG-XM	A53
CNMG-ZM	A55
CNMM	A60
CNMM-DR	A58
CNMM-ER	A58
CNMM-HDR	A60
CNMM-HPR	A60
CNMM-LR	A59
CNMM-RF	A114
CNMM-RH	A114
CPGT-SF	A124
CPGW	A124
CPMT-HF	A124
CPMT-HM	A124

D

DCGT-1 (PCD)	A184
DCGT-1MED (PCD)	A185
DCGT-SF	A125
DCGW-1 (PCD)	A186
DCGW-2 (PCBN)	A169
DCGX-LC	A129
DCGX-LH	A130
DCMT-AHF	A125
DCMT-EF	A126
DCMT-EM	A127
DCMT-HF	A126
DCMT-HM	A128
DCMT-HR	A129
DCMT-XF	A126

DCMT-XM	A127
DCMW	A129
DNEG-NF	A66
DNEG-NGF	A66
DNGA (Ceramic)	A204
DNGA-1 (PCD)	A178
DNGA-2 (PCBN)	A161
DNGN (Ceramic)	A205
DNGX (Ceramic)	A206
DNMA	A69
DNMG-ADF	A62
DNMG-DF	A62
DNMG-DM	A64
DNMG-DR	A68
DNMG-EF	A66
DNMG-EG	A67
DNMG-EM	A67
DNMG-ER	A69
DNMG-FM	A66
DNMG-NM	A67
DNMG-PM	A64
DNMG-SF	A62
DNMG-SNR	A68
DNMG-TC	A67
DNMG-TK	A68
DNMG-XF	A63
DNMG-XM	A63
DNMG-ZM	A65
DNMM-DR	A70
DNMM-ER	A70
DNMM-HDR	A70
DNMM-LR	A70
DNMX-WG	A62
DPGT-SF	A131

H

HNEX-DR	B64
HNGX-HDR	B218
HNGX-MR	B218

K

KNUX	A113
------	------

L

LNCX	B220
LNE32.534	B219

LNKT-GL	B120
	B122
LNKT-GM	B120
	B122
LNKT-ZR	B66
	B73
	B80
LNXX-RF	A115
LNXX-RH	A115

M

MPHT-DM	B156
	B158
	B176

O

ODHT-GH	B47
ODHT-GL	B47
ODHT-GM	B47
ODHT-LH	B47
ODMT-GM	B47
OFKR-DF	B45
OFKR-DM	B45
OFKR-LH	B45
OFKT-DF	B43
OFKT-DM	B43
OFKT-LH	B43
ONHU-CM	B49
	B51
ONHU-GH	B56
ONHU-GL	B56
ONHU-GM	B56
ONHU-PF	B49
	B51
ONHU-PM	B49
	B51

P

PNEG-CF	B59
	B61
PNEG-CM	B59
	B61
PNEG-CR	B59
	B61
PNEG-PF	B58
	B61
PNEG-PM	B58
	B61

PNEG-PR	B58
	B61

Q

QC**R/L	A417
QC**R/L***R	A420

R

R/L*****N-A(G)	A469
R/L*****N-A(G)B	A486
R/L*****N-AC	A480
R/L*****N-AP	A482
R/L*****N-BPTB	A491
R/L*****N-BSPT	A473
R/L*****N-BSPTB	A490
R/L*****N-BUT	A484
R/L*****N-GM	A467
R/L*****N-GMB	A485
R/L*****N-NPT	A474
R/L*****N-NPTF	A475
R/L*****N-R	A476
R/L*****N-RT	A483
R/L*****N-STAC	A481
R/L*****N-TR	A479
R/L*****N-UN	A472
R/L*****N-UNB	A489
R/L*****N-W	A471
R/L*****N-WB	A488
R/L****W-A(G)	A470
R/L****W-A(G)B	A486
R/L****W-AC	A480
R/L****W-AP	A482
R/L****W-BPTB	A491
R/L****W-BSPT	A473
R/L****W-BSPTB	A490
R/L****W-BUT	A484
R/L****W-GM	A467
R/L****W-GMB	A485
R/L****W-MJ	A477
R/L****W-NPT	A474
R/L****W-NPTF	A475
R/L****W-R	A476
R/L****W-RT	A483
R/L****W-STAC	A481
R/L****W-TR	A479
R/L****W-UN	A472
R/L****W-UNB	A489
R/L****W-UNJ	A478
R/L****W-W	A471

A

Turning

B

Milling

C

Drilling

D

Technical
Information

E

Index

A	R/LT****W-WB	A488	SCMT-XM	A135	SNMG-ADF	A71
	RCGX (Ceramic)	A218	SDMT	B135	SNMG-DF	A71
	RCGX-LH	A132	SDMT-DM	B164	SNMG-DM	A75
	RCKT-DM	B89		B167	SNMG-DR	A77
		B92		B198	SNMG-EF	A72
	RCKT-DR	B89		B211	SNMG-EG	A75
		B92		SDMT-NM	SNMG-EM	A76
	RCKT-ER	B89		SDMT-PM	SNMG-ER	A78
		B92			SNMG-NM	A77
	RCKT-NM	B89			SNMG-PM	A74
B92				SNMG-SF	A71	
B	RCMT	A132	SEEN	B41	SNMG-SNR	A78
	RCMX	A133	SEET-APF	B77	SNMG-TC	A76
	RCMX-1	A133	SEET-APM	B77	SNMG-TK	A76
	RCMX-PV	A133	SEET-APR	B77	SNMG-XF	A73
	RDKT-MM	B95	SEET-CF	B35	SNMG-XM	A73
		B99		B37	SNMM	A85
		B205	SEET-CM	B35	SNMM-DR	A79
	RDKW	B95		B37	SNMM-ER	A79
		B99	SEET-CR	B35	SNMM-HDR	A81
		B205		B37	SNMM-HPR	A82
RDKW-1	B97	SEET-DF	B35	SNMM-LR	A80	
	B101		B37	SNUN	A86	
	B205	SEET-DM	B35	SPCN	B222	
RDKW-2	B207		B37	SPGN	B225	
	B97	SEET-DR	B35	SPGT-EM	B215	
	B101		B37		C34	
RDKW-3	B205	SEET-EF	B35	SPGT-PM	B215	
	B207		B37		C34	
	B97	SEET-EM	B35	SPKN	B70	
C		B99		B37	SPKR	B71
		B101	SEET-LH	B35	SPKR-GM	B71
		B207		B37	SPKT	B68
	RNGA (Ceramic)	A207	SEET-PF	B77	SPKW	B68
	RNGN (PCBN)	A174	SEET-PM	B77	SPMR	B223
	RNMG	A112	SEET-PR	B77	SPMT	B135
	ROHX	B137	SEET-W	B34		B184
	RPGN (Ceramic)	A219		B37		B186
	RPGX (Ceramic)	A220	SEKN	B40		B188
	D			SEKR	B41	
			SNEG-E	B53		B192
			SNEG-GM	B53		B194
			SNEG-GR	B53	SPMT-HT	B224
			SNEG-HGR	B53	SPMT-KT	B135
			SNEG-W	B54		B224
			SNGA (Ceramic)	A210	SPMT-PM	B178
			SNGA-4 (PCBN)	A162		B180
			SNGN (PCBN)	A175		B182
			SNGX (Ceramic)	A213	SPMW	A138
E			SNKN	B221	SPMX-EM	C33
	SCGX-LC	A136	SNMA	A84	SPMX-LM	C33
	SCGX-LH	A137	SNMG	A83	SPMX-XM	C33
	SCMT-AHF	A134				
	SCMT-EF	A134				
	SCMT-EM	A134				
	SCMT-HF	A135				
	SCMT-HM	A135				
	SCMT-HR	A136				
	SCMT-XF	A134				

SPUN B225

T

TBGH A139
 TCGT-1 (PCD) A187
 TCGT-1MED (PCD) A187
 TCGT-L (PCD) A188
 TCGT-SF A140
 TCGW-1 (PCD) A189
 TCGW-3 (PCBN) A170
 TCGW-L (PCD) A190
 TCGX-LC A145
 TCGX-LH A145
 TCMT A144
 TCMT-AHF A141
 TCMT-EF A142
 TCMT-EM A142
 TCMT-HF A141
 TCMT-HM A143
 TCMT-HR A143
 TCMT-XF A141
 TCMT-XM A142
 TCMW A143
 TNGA (Ceramic) A214
 TNGA-3 (PCBN) A163
 TNGN (Ceramic) A215
 TNMA A99
 TNMG A98
 TNMG-ADF A87
 TNMG-DF A87
 TNMG-DM A91
 TNMG-DR A94
 TNMG-EF A89
 TNMG-EG A93
 TNMG-EM A93
 TNMG-ER A95
 TNMG-FM A90
 TNMG-PM A91
 TNMG-SF A88
 TNMG-SNR A92
 TNMG-TC A93
 TNMG-XM A90
 TNMG-ZM A92
 TNMM A99
 TNMM-DR A95
 TNMM-HDR A97
 TNMM-LR A95
 TNMX-WG A87
 TPGH A146
 TPGN (Ceramic) A221

TPGT-SF A147
 TPKN B75
 B226
 TPMR B227
 TPUN B227

V

VBET-NF A149
 VBET-NGF A151
 VBGT-1 (PCD) A191
 VBGT-1MED (PCD) A191
 VBGT-SF A150
 VBGW-1 (PCD) A192
 VBGW-2 (PCBN) A171
 VBMT-AHF A148
 VBMT-EF A148
 VBMT-EM A151
 VBMT-HF A149
 VBMT-HM A151
 VBMT-HR A152
 VBMT-SNR A152
 VBMT-XF A148
 VBMT-XM A151
 VCGT A153
 VCGT-1 (PCD) A193
 VCGT-1MED (PCD) A194
 VCGT-HF A153
 VCGT-NF A153
 VCGT-SF A153
 VCGW-1 (PCD) A195
 VCGW-2 (PCBN) A172
 VCGX-LC A154
 VCGX-LH A155
 VCMT-EF A156
 VCMT-EM A156
 VCMT-XF A156
 VCMT-XM A156
 VNEG-NF A100
 VNEG-NGF A101
 VNGA (Ceramic) A216
 VNGA-1 (PCD) A179
 VNGA-2 (PCBN) A164
 VNMG A103
 VNMG-ADF A100
 VNMG-DF A100
 VNMG-DM A103
 VNMG-EF A100
 VNMG-EM A103
 VNMG-NM A103
 VNMG-PM A104

VNMG-SF A101
 VNMG-SNR A104
 VNMG-TC A104
 VNMG-XF A102
 VNMG-XM A102
 VNMG-ZM A104

W

WCMX-53 C35
 WCMX-D C35
 WCMX-PG C35
 WNEG-NF A106
 WNGA (Ceramic) A217
 WNGA-3 (PCBN) A165
 WNGN (PCBN) A176
 WNGN-M (PCBN) A176
 WNHU-GM B82
 B84
 WNMA A111
 WNMG-ADF A105
 WNMG-DF A105
 WNMG-DM A108
 WNMG-DR A111
 WNMG-EF A106
 WNMG-EG A108
 WNMG-EM A108
 WNMG-NF A106
 WNMG-NM A110
 WNMG-PM A109
 WNMG-SF A105
 WNMG-SNR A109
 WNMG-TC A110
 WNMG-TK A110
 WNMG-WG A106
 WNMG-XF A107
 WNMG-XM A107
 WNMG-ZM A109
 WPGT B169
 B171
 B200
 WPGT-PM B169
 B171
 B200

X

XEEC B87

A

Turning

B

Milling

C

Drilling

D

Technical
Information

E

Index

A

XPHT-GM	B139
	B141
	B143
	B145
	B196
XSEQ	B152
	B154

Turning

Z

B

ZDET	B134
ZDET-PM	B134
ZIGQ-NM	A413
ZILD-LC	A415
ZIMF-NM	A412
ZNEX (PCBN)	A166
ZOHX-GF	B147
	B149
	B209
ZOHX-GM	B147

Milling

C

	B149
	B209
ZP*D-MG-R/L	A401
ZP*S-MG	A402
ZP*S-MG-R/L	A403
ZPD-MG	A400
ZPNT	B134
ZR*D-EG	A411
ZR*D-LH	A414
ZR*D-MG	A410
ZT*D-EG	A407
ZT*D-MG	A404
ZT*D-MM	A399
ZT*S-MG	A405
ZT*S-MM	A406

Drilling

D

Technical Information

E

Index

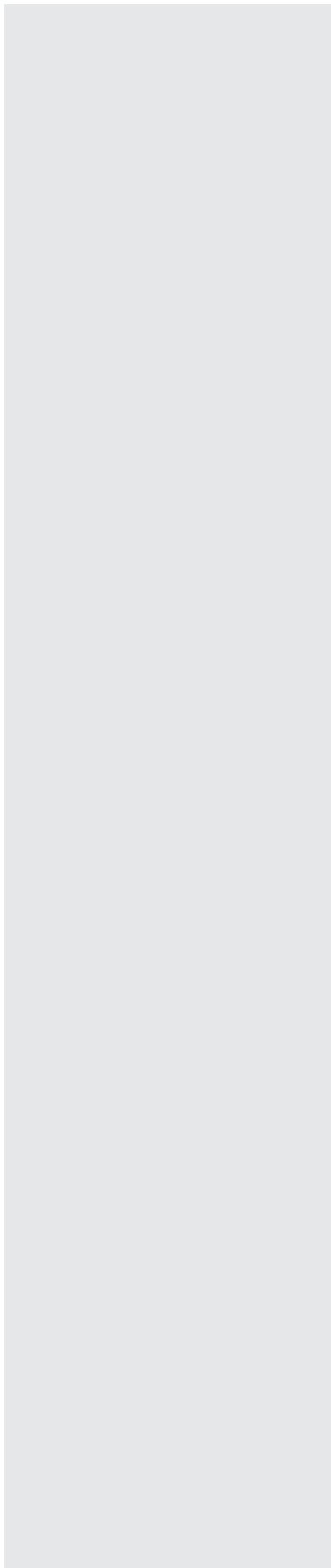

1

1101SC05	C132
1105SC03	C129
1143SC120	C142
1143SC142	C143
1143SC90	C141
1165PA03	C133
1534GD03C	C118
1534SH03	C127
1534SP03C	C104
1534SU03	C48
1534SU03C	C48
1534UD03C	C110
1536GD05C	C121
1536SU05	C59
1536SU05C	C59
1536UD05C	C113
1538SU08C	C69
1557SU03	C88
1576PC05	C137
1576PC05C	C137
1579PC15C	C139
1588SL10C	C89
1588SL12C	C92
1588SL15C	C96
1588SL20C	C99
1588SL30C	C102
1634SU03C	C72
1636GD05C	C124
1636SU05C	C76
1734SU03C	C80
1736SU05C	C84

3

3101H7	C157
3102H7	C158
3103H7	C163
3112H7	C159

4

4111	C191
4122A	C177
4122M	C180
4201A	C187
4201C	C183
4202A	C189
4202C	C185

4222A	C178
4222M	C181

5

5501/5601	B479
5501R302GM	B283
5501R303GM	B298
5501R304GF	B312
5501R38414GM	B455
5502R302GM	B285
5502R303GM	B300
5502R304GF	B314
5502R38414GM	B456
5502R38414GM-R	B459
5502R402NM	B411
5502R453GM	B302
5502R55MHH	B397
5508R454GM	B316
5565R302GF	B321
5565R302NH	B422
5566R302GF	B323
5566R302NH	B423
5589R45MGFR	B318
5601	B480
5601R302GM	B284
5601R303GM	B299
5601R304GF	B313
5601R38414GM	B457
5602R302GM	B286
5602R303GM	B301
5602R303GR	B335
5602R304GF	B315
5602R304GR	B336
5602R305GR	B337
5602R38414GM	B458
5602R38414GM-R	B460
5602R453GM	B303
5602R454GM	B317
5665R202GM	B322

A

A***-PCLNR/L	A324
A***-PDSNR/L	A326
A***-PDUNR/L	A327
A***-PSKNR/L	A329
A***-PTFNR/L	A330
A***-SCLCR/L	A334
A***-SDQCR/L	A336
A***-SDUCR/L	A337

A***-SDZCR/L	A338
A***-SSKCR/L	A339
A***-STFCR/L	A341
A***-SVQBR/L	A345
A***-SVUBR/L	A346
AL-2B	B424
AL-2E	B417
AL-2EL	B418
AL-2R-AIR	B425
AL-2RL-AIR	B426
AL-3E	B419
AL-3EL	B420
AL-3R-AIR	B427
AL-3RL-AIR	B428
AL-3W	B421
ALG-2E	B429
ALG-2R	B436
ALG-2R-W	B437
ALG-3E	B430
ALG-3E-W	B431
ALP-3E	B432
ALP-3E-W	B433
ALP-4E	B434
ALP-4E-W	B435

B

BMR01	B133
BMR02	B136
BMR03	B138
BMR04	B146

C

C***-SCLPR/L	A354
C***-SDQPR/L	A356
C***-SDUPR/L	A358
C***-STUPR/L	A360
C***-SVQCR/L	A363
C***-SVUCR/L	A364
C***-SZLNR/L	A365
C40X-Q*DR/L	A443
CCLNR/L	A292
CDJNR/L	A294
CKJNR/L	A290
CKNNR/L	A291
CMA01	B187
CMD01	B191
CMZ01	B183
CRDNN	A298
CSDNN	A299

A

Turning

B

Milling

C

Drilling

DTechnical
Information**E**

Index

A

Turning

B

Milling

C

Drilling

D

Technical Information

E

Index

CSKNR/L A296
 CSRNR/L A297
 CTJNR/L A293
 CTUNR/L A295

D

DCLNR/L A230
 DDJNR/L A231
 DSBNR/L A232
 DTGNR/L A233
 DVJNR/L A235
 DVVNN A234
 DWLNR/L A236

E

E***-SCLCR/L A355
 E***-SCLPR/L A354
 E***-SDQCR/L A357
 E***-SDUCR/L A359
 E***-STFCR/L A361
 E***-STFPR/L A362
 E***-SVUCR/L A364
 EMP01 B103
 EMP02 B109
 EMP03 B113
 EMP04 B115
 EMP05 B117
 EMP09 B119
 EMP13 B123
 EPM-2B B379
 EPM-2B-W B380
 EPM-2BL B381
 EPM-2BL-W B382
 EPM-2E B371
 EPM-2E-W B372
 EPM-2EL B373
 EPM-2EL-W B374
 EPM-4B B383
 EPM-4B-W B384
 EPM-4BL B385
 EPM-4BL-W B386
 EPM-4E B375
 EPM-4E-W B376
 EPM-4EL B377
 EPM-4EL-W B378

F

FMA01 B33
 FMA02 B36
 FMA03 B39
 FMA04 B46
 FMA07 B50
 FMA11 B52
 FMA12 B55
 FMD02 B57
 FMD03 B65
 FME02 B67
 FME03 B69
 FME04 B72
 FMP01 B74
 FMP02 B76
 FMP03 B79
 FMP12 B81
 FMR01 B88
 FMR02 B90
 FMR03 B94
 FMR04 B98
 FMWX B86

G

G*-QCH
 GM-2B B324
 GM-2BFP B326
 GM-2BL B325
 GM-2BP B328
 GM-2BS B327
 GM-2E B287
 GM-2EFP B290
 GM-2EL B288
 GM-2EP B293
 GM-2ES B295
 GM-2EX B289
 GM-2F B291
 GM-2FL B292
 GM-2R B332
 GM-3E B296
 GM-3EL B297
 GM-4B B330
 GM-4BL B331
 GM-4E B308
 GM-4E-G B309
 GM-4EFP B311
 GM-4EL B310
 GM-4EL-G B305
 GM-4EX-G B307

GM-4F-G B304
 GM-4FL-G B306
 GM-4R B333
 GM-4RL B334
 GM-4W B338
 GM-6E B319
 GM-6EL B320
 GQC**R/L A453

H

HM-2B B400
 HM-2BFP B402
 HM-2BL B401
 HM-2BP B404
 HM-2BS B403
 HM-2E B389
 HM-2EFP B390
 HM-2EP B391
 HM-2ES B393
 HM-4B B406
 HM-4BL B407
 HM-4E B394
 HM-4EFP B396
 HM-4EL B395
 HM-4R B408
 HM-4RF B409
 HM-4RP B410
 HM-6E B398
 HM-6EL B399
 HMP01 B177
 HMP01-EC B181

J

JCLNR/L A300
 JDJNR/L A301
 JSDNN A302

M

MCBNR/L A252
 MCLNR/L A253
 MDJNR/L A254
 MDPNN A255
 MRDNN A267
 MRGNR/L A268
 MSBNR/L A256
 MSDNN A259
 MSKNR/L A258

MSRNR/L	A257
MTFNR/L	A263
MTGNR/L	A260
MTJNR/L	A261
MVJNR/L	A265
MVVNN	A264
MWLNRL	A266

N

NM-2B	B415
NM-2BP	B416
NM-2E	B412
NM-2EP	B413
NM-4E	B414

P

PCBNR/L	A237
PCLNR/L	A238
PDJNR/L	A240
PDNNR/L	A241
PM-2B	B348
PM-2BC	B351
PM-2BFP	B350
PM-2BL	B349
PM-2BP	B365
PM-2BS	B364
PM-2E	B339
PM-2EL	B340
PM-2EP	B362
PM-2ES	B361
PM-2R	B356
PM-2RP	B367
PM-4B	B354
PM-4BL	B355
PM-4E	B344
PM-4E-G	B341
PM-4EL	B345
PM-4EL-G	B342
PM-4EX-G	B343
PM-4H	B357
PM-4HL	B358
PM-4R	B359
PM-4RL	B360
PM-6E	B346
PM-6EL	B347
PSBNR/L	A242
PSDNN	A244
PSKNR/L	A245
PSSNR/L	A246

PTFNR/L	A247
PTGNR/L	A249
PTTNR/L	A248
PWLNRL	A251

Q

Q*DR/L	A444
Q-QCH-HMX-2B	B486
Q-QCH-HMX-4B	B487
Q-QCH-HMX-4E	B488
Q-QCH-HMX-4R	B489
Q-QCH-PM-2B	B481
Q-QCH-PM-4B	B482
Q-QCH-PM-4E	B483
Q-QCH-PM-4R	B484
Q-QCH-VPM-4E	B485
QCH-APKT	B201
QCH-APKT-Q	B212
QCH-RD	B204
QCH-SDMT	B197
QCH-SDMT-Q	B210
QCH-SPGT-Q	B214
QCH-WPGT	B199
QCH-XPHT	B195
QCH-ZOHX	B208
QE**R/L	A425
QE**R/L-DGC	A446
QE**R/L-DGSC	A448
QE**R/L-SC	A449
QE*S**N	A432
QE*S**N-1	A432
QE*SN30	A427
QE*SR/L	A430
QEBDR/L	A425
QECDR/L	A428
QF**R/L	A434
QF**RR/LL	A436
QF*DRR/LL	A439
QX**R/L	A429
QZS*	A433

S

S***-PCLNR/L	A324
S***-PDSNR/L	A326
S***-PDUNR/L	A327
S***-PSKNR/L	A329
S***-PTFNR/L	A330
S***-PWLNRL	A332
S***-SCFCR/L	A352

S***-SCLCR	A353
S***-SCLCR/L	A334
S***-SCLPR/L	A348
S***-SDQCR/L	A336
S***-SDQPR/L	A349
S***-SDUCR/L	A337
S***-SDUPR/L	A350
S***-SDZCR/L	A338
S***-SSKCR/L	A339
S***-STFCR/L	A341
S***-STUPR/L	A351
S***-SVQBR/L	A345
S***-SVQCR/L	A343
S***-SVUBR/L	A346
S***-SVUCR/L	A344
S***-SVXBR/L	A347
S*K-QC**R/L	A454
SCACR/L	A269
SCACR/L-SC	A306
SCLCR/L	A270
SCLCR/L-SC	A307
SDACR/L	A271
SDACR/L-SC	A308
SDHCR/L-SC	A309
SDJCR/L	A272
SDJCR/L-SC	A310
SDNCN	A273
SDNCN-SC	A311
SMP01	B151
SMP03	B155
SMP05	B159
SNL	A496
SNR	A495
SRDCN	A288
SRGCR/L	A289
SSBCR/L	A279
SSDCN	A280
SSKCR/L	A281
SSSCR/L	A282
STACR/L	A283
STFCR/L	A284
STGCR/L	A285
STTCR/L	A286
SVABR/L	A275
SVACR/L-SC	A312
SVJBR/L	A274
SVJCR/L	A278
SVJCR/L-SC	A313
SVVBN	A276
SVVCN	A277
SWACR/L	A287
SWL	A494

A

Turning

B

Milling

C

Drilling

DTechnical
Information**E**

Index

A	
Turning	
B	
Milling	
C	
Drilling	
D	
Technical Information	
E	
Index	

SWR A493

T

TM-4B B439
 TM-4BL B440
 TM-4BP B441
 TM-4R B445
 TM-4RP B447
 TM-5B B442
 TM-5BL B443
 TM-5BP B444
 TM-5R B449
 TM-5RP B452
 TM-7R B450
 TM-7RP B453
 TM-9R B451
 TM-9RP B454
 TMP01 B175

U

UM-4E B461
 UM-4E-W B462
 UM-4EFP B466
 UM-4EL B463
 UM-4EL-W B464
 UM-4ELP-W B465
 UM-4R B467
 UM-4RFP B469
 UM-4RL B468
 UM-5EP-W B470
 UMC-4E B471
 UMC-4E-W B472

V

VPM-4E B387
 VSM-4E B473
 VSM-4E-C B474
 VSM-4R B475

X

XMP01 B173
 XMR01 B165

Z

ZD03 C30
 ZSD02 C10
 ZSD03 C13
 ZSD04 C16
 ZSD05 C19
 ZTD02 C22
 ZTD03 C24
 ZTD04 C26
 ZTD05 C28



Grinding of solid carbide tools



Grinding of inserts

New ZCC Cutting Tools Industrial Park, Zhuzhou, China



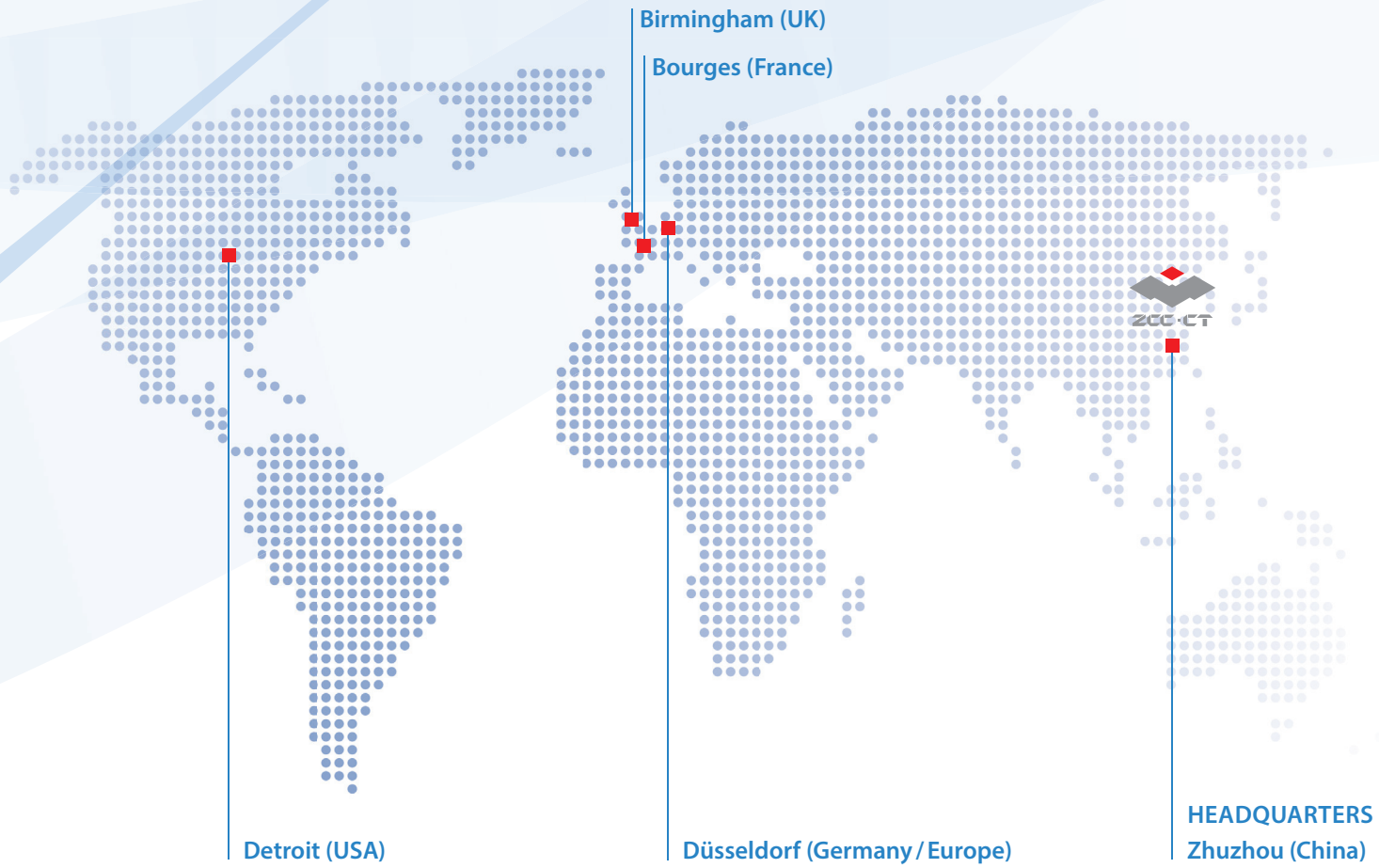

About the company

Zhuzhou Cemented Carbide Cutting Tools Co., Ltd. (ZCC-CT), based in Zhuzhou, China, is the largest Chinese manufacturer of carbide tools. It is also a key company of China Tungsten High-Tech Material Co. Ltd. part of the China Minmetals Corporation.

Since its founding in 1953, ZCC Cutting Tools Co., Ltd. has grown to become one of the world's leading carbide manufacturers with more than 2,000 employees by using the latest technologies and employing highly skilled personnel. The company continuously modernises production technologies and expands its production capacities to enable the company's ongoing growth. As part of Minmetals Corporation, ZCC-CT is able to cover the entire value chain of modern carbide tool production itself, from raw material extraction through to the coated end product and all associated intermediate steps.

By drawing on the latest in European production technology, the company offers products that consistently meet the highest quality standards. Our extensive product range includes carbide/solid carbide, cermet, CBN, PCD and ceramic inserts, carbide tools, tool holders, milling bodies and the accompanying tool systems. All products are consistently produced to accepted international standards, including ISO, DIN, ANSI, JIS and BSI. In addition, ZCC-CT offers customised solutions and special carbide products built to individual specifications.

ZCC-CT invests heavily in research and development and uses the world's most advanced equipment and machinery, including those made in Germany and Switzerland. The associated investments go beyond that of most competitors. ZCC Cutting Tools' excellently trained engineers, scientists and a competent, international team, research the necessary fundamentals. These form the basis for the ongoing development of new products and the improvement of existing ones.

The company continuously introduces improvements in quality to meet the customers' ever-increasing demands for new and innovative products and to maximise the benefit of each individual customer. Both production and administration in China are subject to the ISO 9001:2008 standard, while environmental management is subject to the requirements set out in ISO 14001:2004.

The foundation of the European headquarters of ZCC-CT, ZCC Cutting Tools Europe GmbH and the European central warehouse, both located in Düsseldorf (Germany), *dates back to 2003. Today, all European countries as well as the adjacent markets are served from there.*

The quality management system of ZCC Cutting Tools Europe GmbH is certified in the area of 'distribution and logistics of metal-working tools' in accordance with ISO 9001:2008.

The company operates a production site in Germany and has been an active member of the VDMA since 2019.

The UK branch is also a member of the Manufacturing Technologies Association (MTA).

To meet our exceptionally high standards for customer services, the number of staff ZCC Cutting Tools Europe GmbH employs in external and internal sales, technical support and application technology, research and development, and naturally also in logistics, marketing, IT, HR and accounting, is growing as the company continues to expand. The management system is continuously upgraded to keep stride with the company's growth.

The company introduced its own research and development department that exclusively focuses on the requirements of the European markets. It operates in close collaboration and coordination with the research and development department in China. This department, together with the test and demonstration centre opened in Düsseldorf in 2019 for the testing and presentation of innovative solutions, underline the importance of customer and market-oriented services at ZCC Cutting Tools Europe GmbH. The test and demonstration centre is also available for optimizing customer processes according to individual requirements.

External sales staff and distribution partners in Europe work hand in hand to support customers across the region. Our friendly ZCC-CT application engineers are also available to support you with their expertise and experience by phone, e-mail or in person at your production facility.

The entire field and office sales force is available to answer enquiries from clients across Europe in their native language. Together with employees from the logistics team and with the help of a sophisticated service system, they ensure that all orders are delivered as quickly as possible to you. Branch offices in France and Great Britain add to additional regional proximity to customers.

ZCC Cutting Tools Europe GmbH and all of our employees are there for you and have your back as a competent partner for all matters concerning machining production. This is how we define 'your partner – your value'.

Main Catalogue

Version 2023



700 | CAT | v2022.07 | 5.5 | 07.22

European Headquarters

ZCC Cutting Tools Europe GmbH

www.zccct-europe.com

Wanheimer Str. 57, 40472 Düsseldorf, Germany

Tel.: +49 (0) 211-989240-0

Fax: +49 (0) 211-989240-111

E-mail: info@zccct-europe.com

Branch Office France

ZCC Cutting Tools Europe GmbH Succursale Française

www.zccct-europe.com

14, Allée Charles Pathé, 18000 Bourges, France

Tel.: +33 (0) 2 45 41 01 40

Fax: +33 (0) 800 74 27 27

E-mail: ventes@zccct-europe.com

Branch Office UK

ZCC Cutting Tools Europe GmbH UK Division

www.zccct-europe.com

4200 Waterside Centre, Solihull Parkway,
Birmingham Business Park.

Birmingham, West Midlands, B37 7YN, UK

Tel.: +44 (0) 121-809 5469

Fax: +49 (0) 211-989240-111

E-mail: infouk@zccct-europe.com



ZCC Cutting Tools
Europe GmbH

© Copyright by ZCC Cutting Tools Europe GmbH
All rights reserved.