



---

AUGUST 2023



- 1-3 ZMM BULGARIA HOLDING
- 4-19 UNIVERSAL LATHES
- 20-35 UNIVERSAL LATHES WITH VARIABLE SPINDLE SPEED CONTROL
- 36-41 OIL COUNTRY LATHES
- 42-55 CNC LATHES
- 56-59 NEW DEVELOPMETS
- 60-61 LATHE MACHINE OPTIONAL ACCESSORIES

**WE DO NOT JUST ASSEMBLE.  
WE MANUFACTURE.**



## ZMM BULGARIA HOLDING



ZMM Bulgaria Holding belongs to the family of **Industrial Holding Bulgaria**. One of the most significant industrial groups in the country, IHB operates mainly in the maritime transport business, ship building and repair, port operations, machine building.

For more information, please visit [www.bulgariaholding.com](http://www.bulgariaholding.com)

**ZMM Bulgaria Holding** is a privately owned company and a leading manufacturer of universal and CNC lathes. The Holding was established in 2001 and currently manages three production facilities, where it employs about 600 professionals.

- **ZMM Sliven:** manufacture of universal lathes, lathes with variable speed control, oil-country lathes, and CNC lathes.
- **IHB Metal Castings:** castings from gray cast iron according to EN 1561/2000; castings from nodular cast iron according EN 1563; patterns.
- **ZMM Nova Zagora:** design and manufacture of assemblies and parts for metal cutting and general machinery products.



ZMM Sliven production plant  
[www.zmmsliven.com](http://www.zmmsliven.com)



ZMM Nova Zagora production plant  
[www.zmmnz.com](http://www.zmmnz.com)



IHB Metal Castings foundry  
[www.ihbmetalcastings.com](http://www.ihbmetalcastings.com)





### UNIVERSAL LATHES

Our universal lathes and lathes with infinitely variable spindle speed control have diverse features and accessories to meet the needs of clients in various industries and geographical locations. Standard on every machine are metric, inch, module and diametrical pitch threads. Distance between centers varies between 500 mm and 10,000 mm and center height between 165 mm and 705 mm. Our lathes are affordable, rugged, reliable and easy to operate. They are built to last and are known for consistent performance and durability even under the most demanding work conditions.



### OIL COUNTRY LATHES

Our oil country lathes are designed for turning pipes and pipe fittings for the oil and gas industry. These machines can be used for a variety of turning operations, including cutting metric, inch, module and pitch threads. A standard machine includes two 3-jaw self-centering chucks, a taper turning attachment, two stands - one with fixed steady and one with rolling quills. Our spindles are assembled with preloaded angular contact bearings from leading manufacturers like 'SKF' and 'FAG'. All major components are manufactured from stainless steel, which ensures reliable operation and accuracy.



### CNC LATHES AND CYCLIC CNC LATHES

Our CNC lathes are available with control systems and servo drives from Siemens, Heidenhain, Fanuc, and Fagor. CNC lathes have a maximum turning diameter over bed of 500, 890, 1090, and 1320 mm. They are designed to perform a wide range of turning operations on medium, large and oversized parts in small and medium series production.

Cyclic CNC lathes, although at significantly lower prices than the CNC models, are equally functional and reliable. Longer life expectancy and ease of operation are among their major advantages.



### NEW DEVELOPMENTS

Cyclic lathe LS 600M allows the operator to select manual, automatic or combined mode of operation, which achieves more precise processing of the workpiece and flexibility when changing operations.

The lathe model LT1500 is a machine that uses CNC technology and is specifically designed for wheelset reprofiling.

ZMM Bulgaria is among the world's most experienced manufacturers of universal, oil country and CNC lathes and their modifications with infinitely variable spindle speed control. We are well acquainted with customers' needs and are able to render all necessary information, training and technical support at any time – directly or through our distributors. Our service engineers are available and ready to help you out. All you have to do is ask for our machine tool service representative.

All of our equipment comes fully assembled, clearly labeled and includes product manuals with detailed instructions. Our goal is to make installation as easy as possible so you can start producing. If you still have questions after receiving your machine, contact us. We are ready to help.

Fast access to spare parts can help you keep your machines running, control costs, extend the life of your equipment and maintain production levels.



# CU325



For illustration purpose only



# UNIVERSAL LATHES

## STANDARD MACHINE SPECIFICATIONS

|           |                                  |        | CU325                       |
|-----------|----------------------------------|--------|-----------------------------|
| CAPACITY  | Height of centers                | mm     | 165                         |
|           | Swing over bed                   | mm     | 325                         |
|           | Swing over cross slide           | mm     | 190                         |
|           | Swing in gap – only DBC 1000mm** | mm     | 440                         |
|           | Width of bed                     | mm     | 200                         |
| SPINDLE   | Distance between centers         | mm     | 500; 750; 1000              |
|           | Spindle nose DIN 55027           | No     | 5                           |
|           | Spindle bore                     | mm     | 32                          |
| HEADSTOCK | Spindle taper                    | Morse  | No. 4,5                     |
|           | Number of spindle speeds         |        | 12 ( 24 )                   |
|           | Spindle speed ranges             | rpm    | 85 – 2000 ( 42,5 – 2000 ) * |
| FEEDS     | Main motor power                 | kw     | 2,2                         |
|           | Number of feeds                  |        | 48                          |
|           | Longitudinal feed range          | mm/rev | 0,006 – 1,77                |
| THREADS   | Cross feed range                 | mm/rev | 0,003 – 0,885               |
|           | Number of threads                |        | As below                    |
|           | Metric thread range              | mm     | ( 48 ) 0,1 – 28             |
|           | Inch thread range                | Tpi    | ( 53 ) 75 – 2,5             |
|           | Module thread range              | Module | ( 19 ) 0,1 – 1,75           |
| CARRIAGE  | DP thread range                  | DP     | ( 19 ) 70 – 4               |
|           | Cross slide travel               | mm     | 150                         |
|           | Top slide travel                 | mm     | 95                          |
| TAILSTOCK | Quill diameter                   | mm     | 40                          |
|           | Quill taper                      | Morse  | No.3                        |
|           | Quill travel                     | mm     | 100                         |
| WEIGHT    | For DBC 1000 mm                  | kg     | 770                         |

\* Only for two-speed motor execution

\*\* With option machine bed gap

# C400TM



For illustration purpose only



# UNIVERSAL LATHES

## STANDARD MACHINE SPECIFICATIONS

| STANDARD MACHINE SPECIFICATIONS |                          |        | C400TM          |
|---------------------------------|--------------------------|--------|-----------------|
| CAPACITY                        | Height of centers        | mm     | 200             |
|                                 | Swing over bed           | mm     | 400             |
|                                 | Swing over cross slide   | mm     | 235             |
|                                 | Swing in gap*            | mm     | 550             |
|                                 | Width of bed             | mm     | 320             |
| SPINDLE                         | Distance between centers | mm     | 750; 1000; 1500 |
|                                 | Spindle nose DIN 55027   | No     | 6               |
|                                 | Spindle bore             | mm     | 52              |
| HEADSTOCK                       | Spindle taper            | Morse  | 6               |
|                                 | Number of spindle speeds |        | 12              |
|                                 | Spindle speed ranges     | rpm    | 50 – 2240       |
| FEEDS                           | Main motor power         | kw     | 4               |
|                                 | Number of feeds          |        | 80              |
|                                 | Longitudinal feed range  | mm/rev | 0,015 – 0,6     |
| THREADS                         | Cross feed range         | mm/rev | 0,0075 – 0,3    |
|                                 | Number of threads        |        | 40 of each kind |
|                                 | Metric thread range      | mm     | 0,25 – 7,5      |
|                                 | Inch thread range        | Tpi    | 120 – 4         |
|                                 | Module thread range      | Module | 0,0625 – 1,875  |
| CARRIAGE                        | DP thread range          | DP     | 480 – 16        |
|                                 | Cross slide travel       | mm     | 235             |
|                                 | Top slide travel         | mm     | 110             |
| TAILSTOCK                       | Quill diameter           | mm     | 60              |
|                                 | Quill taper              | Morse  | No.4            |
|                                 | Quill travel             | mm     | 100             |
| WEIGHT                          | For DBC 1500 mm          | kg     | 1700            |

\* With option machine bed gap

# CU400/CU500

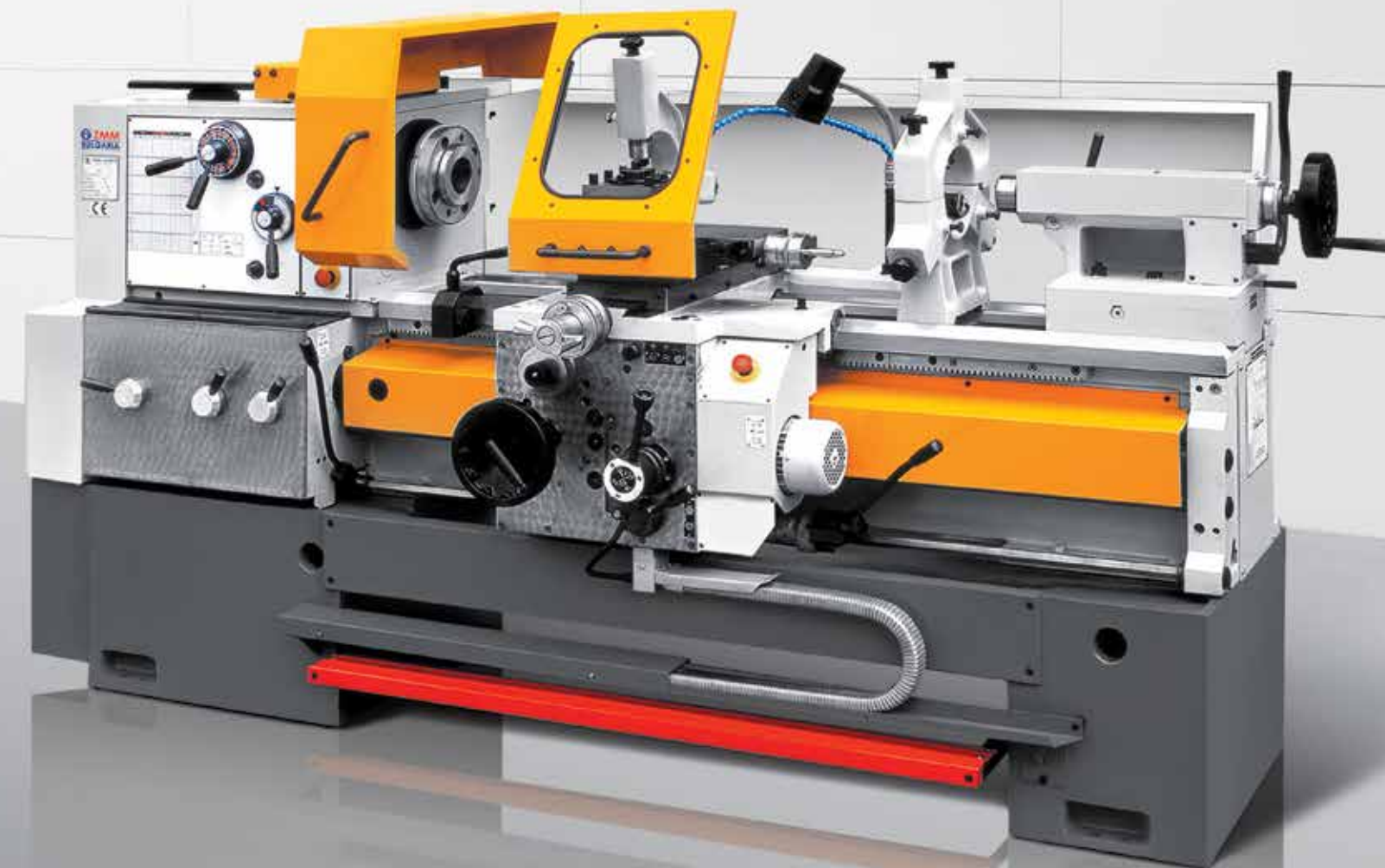

For illustration purpose only

# UNIVERSAL LATHES

## STANDARD MACHINE SPECIFICATIONS

|           |                          |                          | CU400            | CU500           |
|-----------|--------------------------|--------------------------|------------------|-----------------|
| CAPACITY  | Height of centers        | mm                       | 210              | 245             |
|           | Swing over bed           | mm                       | 440              | 500             |
|           | Swing over cross slide   | mm                       | 230              | 300             |
|           | Swing in gap*            | mm                       | 620              | 670             |
|           | Width of bed             | mm                       | 360              |                 |
|           | Distance between centers | mm                       | 1000; 1500; 2000 |                 |
|           | SPINDLE                  | Spindle nose DIN 55027   | No               | 8               |
|           | Spindle bore             | mm                       | 62               |                 |
|           | Spindle taper            | Metric                   | 80               |                 |
|           | HEADSTOCK                | Number of spindle speeds |                  | 21              |
|           | Spindle speed ranges     | rpm                      | 20 – 2000        |                 |
|           | Main motor power         | kw                       | 7,5 (11)         |                 |
|           | FEEDS                    | Number of feeds          |                  | 120             |
|           | Longitudinal feed range  | mm/rev                   | 0,04 – 12        |                 |
|           | Cross feed range         | mm/rev                   | 0,02 – 6         |                 |
|           | THREADS                  | Number of threads        |                  | 64 of each kind |
|           | Metric thread range      | mm                       | 0,5 – 120        |                 |
|           | Inch thread range        | Tpi                      | 60 – 1/4         |                 |
|           | Module thread range      | Module                   | 0,125 – 30       |                 |
|           | DP thread range          | DP                       | 240 – 1          |                 |
| CARRIAGE  | Cross slide travel       | mm                       | 250              |                 |
|           | Top slide travel         | mm                       | 130              |                 |
| TAILSTOCK | Quill diameter           | mm                       | 70               |                 |
|           | Quill taper              | Morse                    | No.5             |                 |
|           | Quill travel             | mm                       | 180              |                 |
| WEIGHT    | For DBC 2000 mm          | kg                       | 2560             | 2630            |

\* With option machine bed gap

# CU400M/ CU500M/ CU580M



For illustration purpose only

# UNIVERSAL LATHES

## STANDARD MACHINE SPECIFICATIONS

|           |                          |                 | CU400M                             | CU500M | CU580M |
|-----------|--------------------------|-----------------|------------------------------------|--------|--------|
| CAPACITY  | Height of centers        | mm              | 220                                | 250    | 290    |
|           | Swing over bed           | mm              | 440                                | 500    | 580    |
|           | Swing over cross slide   | mm              | 240                                | 300    | 380    |
|           | Swing in gap*            | mm              | 640                                | 700    | 780    |
|           | Width of bed             | mm              | 400                                |        |        |
|           | Distance between centers | mm              | 1000; 1500; 2000; 3000; 4000; 5000 |        |        |
| SPINDLE   | Spindle nose DIN 55027   | No              | 8                                  |        |        |
|           | Spindle bore             | mm              | 80                                 |        |        |
|           | Spindle taper            | Metric          | 80                                 |        |        |
| HEADSTOCK | Number of spindle speeds |                 | 21                                 |        |        |
|           | Spindle speed ranges     | rpm             | 20 – 2000                          |        |        |
|           | Main motor power         | kw              | 7,5 ( 11 )                         |        |        |
| FEEDS     | Number of feeds          |                 | 120                                |        |        |
|           | Longitudinal feed range  | mm/rev          | 0,04 – 12                          |        |        |
|           | Cross feed range         | mm/rev          | 0,02 – 6                           |        |        |
| THREADS   | Number of threads        |                 | 64 of each kind                    |        |        |
|           | Metric thread range      | mm              | 0,5 – 120                          |        |        |
|           | Inch thread range        | Tpi             | 60 – 1/4                           |        |        |
|           | Module thread range      | Module          | 0,125 – 30                         |        |        |
|           | DP thread range          | DP              | 240 – 1                            |        |        |
| CARRIAGE  | Cross slide travel       | mm              | 315                                |        |        |
|           | Top slide travel         | mm              | 130                                |        |        |
|           | Quill diameter           | mm              | 90                                 |        |        |
| TAILSTOCK | Quill taper              | Morse           | No.5                               |        |        |
|           | Quill travel             | mm              | 230                                |        |        |
|           | WEIGHT                   | For DBC 2000 mm | kg                                 | 2900   | 2950   |

\* With option machine bed gap

# C11MC



For illustration purpose only

# UNIVERSAL LATHES

## MACHINE SPECIFICATIONS

|                      |                          |                          | C11MC                              |
|----------------------|--------------------------|--------------------------|------------------------------------|
| CAPACITY             | Height of centers        | mm                       | 300                                |
|                      | Swing over bed           | mm                       | 600                                |
|                      | Swing over cross slide   | mm                       | 400                                |
|                      | Swing in gap*            | mm                       | 800                                |
|                      | Width of bed             | mm                       | 400                                |
| SPINDLE              | Distance between centers | mm                       | 1000; 1500; 2000; 3000; 4000; 5000 |
|                      | Spindle nose DIN 55027   | No                       | 8                                  |
|                      | Spindle bore             | mm                       | 80                                 |
|                      | Spindle taper            | Metric                   | 90                                 |
|                      | HEAD STOCK               | Number of spindle speeds |                                    |
| Spindle speed ranges |                          | rpm                      | 20 – 2000                          |
| Main motor power     |                          | kw                       | 7,5                                |
| FEEDS                | Number of feeds          |                          | 120                                |
|                      | Longitudinal feed range  | mm/rev                   | 0,04 – 12                          |
|                      | Cross feed range         | mm/rev                   | 0,02 – 6                           |
| THREADS              | Number of threads        |                          | 64                                 |
|                      | Metric thread range      | mm                       | 0,5 – 120                          |
|                      | Inch thread range        | Tpi                      | 60 – 1/4                           |
|                      | Module thread range      | Module                   | 0,125 – 30                         |
|                      | DP thread range          | DP                       | 240 – 1                            |
| CARRIAGE             | Cross slide travel       | mm                       | 315                                |
|                      | Top slide travel         | mm                       | 130                                |
| TAIL STOCK           | Quill diameter           | mm                       | 90                                 |
|                      | Quill taper              | Morse                    | No.5                               |
|                      | Quill travel             | mm                       | 230                                |
| WEIGHT               | For DBC 2000 mm          | kg                       | 3110                               |

\* With option machine bed gap



# CU500MT/ CU630/ CU730



For illustration purpose only

# UNIVERSAL LATHES

## STANDARD MACHINE SPECIFICATIONS

|           |                          |        | CU500MT                            | CU630       | CU730 |
|-----------|--------------------------|--------|------------------------------------|-------------|-------|
| CAPACITY  | Height of centers        | mm     | 250                                | 315         | 365   |
|           | Swing over bed           | mm     | 500                                | 630         | 730   |
|           | Swing over cross slide   | mm     | 300                                | 430         | 500   |
|           | Swing in gap*            | mm     | 700                                | 830         | 930   |
|           | Width of bed             | mm     | 400                                |             |       |
|           | Distance between centers | mm     | 1000; 1500; 2000; 3000; 4000; 5000 |             |       |
| SPINDLE   | Spindle nose DIN 55027   | No     | 11                                 |             |       |
|           | Spindle bore             | mm     | 103                                |             |       |
|           | Spindle taper            | Metric | 120                                |             |       |
| HEADSTOCK | Number of spindle speeds |        | 15                                 | 21          |       |
|           | Spindle speed ranges     | rpm    | 11,5-1400                          | 12,5 - 1250 |       |
|           | Main motor power         | kw     | 7,5                                | 11          |       |
| FEEDS     | Number of feeds          |        | 120                                |             |       |
|           | Longitudinal feed range  | mm/rev | 0,04 – 12                          |             |       |
|           | Cross feed range         | mm/rev | 0,02 – 6                           |             |       |
| THREADS   | Number of threads        |        | 64 of each kind                    |             |       |
|           | Metric thread range      | mm     | 0,5 – 120                          |             |       |
|           | Inch thread range        | Tpi    | 60 – 1/4                           |             |       |
|           | Module thread range      | Module | 0,125 – 30                         |             |       |
|           | DP thread range          | DP     | 240 – 1                            |             |       |
| CARRIAGE  | Cross slide travel       | mm     | 315                                | 390         |       |
|           | Top slide travel         | mm     | 130                                |             |       |
| TAILSTOCK | Quill diameter           | mm     | 90                                 |             |       |
|           | Quill taper              | Morse  | No.5                               |             |       |
|           | Quill travel             | mm     | 230                                |             |       |
| WEIGHT    | For DBC 2000 mm          | kg     | 3250                               | 3310        | 3500  |

\* With option machine bed gap

# C10T/ C10TM/ C10TH



For illustration purpose only



# UNIVERSAL LATHES

## STANDARD MACHINE SPECIFICATIONS

|           |                          |        | C10T                               | C10TM      | C10TH |
|-----------|--------------------------|--------|------------------------------------|------------|-------|
| CAPACITY  | Height of centers        | mm     | 330                                | 380        | 430   |
|           | Swing over bed           | mm     | 660                                | 760        | 860   |
|           | Swing over cross slide   | mm     | 420                                | 520        | 620   |
|           | Swing in gap*            | mm     | 850                                | 950        | 1050  |
|           | Width of bed             | mm     | 560                                |            |       |
|           | Distance between centers | mm     | 1500; 2000; 3000; 4000; 5000; 6000 |            |       |
| SPINDLE   | Spindle nose DIN 55027   | No     | 11                                 |            |       |
|           | Spindle bore             | mm     | 103                                | 132        |       |
|           | Spindle taper            | Metric | 120                                | 140        |       |
| HEADSTOCK | Number of spindle speeds |        | 15                                 | 17         |       |
|           | Spindle speed ranges     | rpm    | 9-1320                             | 7,5 – 1015 |       |
|           | Main motor power         | kw     | 11                                 | 15         |       |
| FEEDS     | Number of feeds          |        | 150                                |            |       |
|           | Longitudinal feed range  | mm/rev | 0,039 – 18                         |            |       |
|           | Cross feed range         | mm/rev | 0,02 – 9                           |            |       |
| THREADS   | Number of threads        |        | 76 of each kind                    |            |       |
|           | Metric thread range      | mm     | 0,5 – 180                          |            |       |
|           | Inch thread range        | Tpi    | 60 – 1/6                           |            |       |
|           | Module thread range      | Module | 0,125 – 45                         |            |       |
|           | DP thread range          | DP     | 240 – 2/3                          |            |       |
| CARRIAGE  | Cross slide travel       | mm     | 410                                | 435        |       |
|           | Top slide travel         | mm     | 150                                |            |       |
| TAILSTOCK | Quill diameter           | mm     | 105                                |            |       |
|           | Quill taper              | Morse  | No.6                               |            |       |
|           | Quill travel             | mm     | 225                                |            |       |
| WEIGHT    | For DBC 2000 mm          | kg     | 4170                               | 4470       | 4670  |

\* With option machine bed gap

# CU800/ CU1000/ CU1250



For illustration purpose only



# UNIVERSAL LATHES

## STANDARD MACHINE SPECIFICATIONS

|           |                          |        | CU800                              | CU1000 | CU1250  |
|-----------|--------------------------|--------|------------------------------------|--------|---------|
| CAPACITY  | Height of centers        | mm     | 400                                | 500    | 625     |
|           | Swing over bed           | mm     | 890                                | 1090   | 1320    |
|           | Swing over cross slide   | mm     | 490                                | 690    | 940     |
|           | Swing in gap*            | mm     | 1050                               | 1250   | 1500    |
|           | Width of bed             | mm     | 700                                |        |         |
|           | Distance between centers | mm     | 1500; 2000; 3000; 4000; 5000; 6000 |        |         |
| SPINDLE   | Spindle nose DIN 55027   | No     | 15                                 |        |         |
|           | Spindle bore             | mm     | 155                                |        |         |
|           | Spindle taper            | Metric | 160                                |        |         |
| HEADSTOCK | Number of spindle speeds |        | 24                                 |        |         |
|           | Spindle speed ranges     | rpm    | 6,3 -1250                          |        | 5 -1000 |
|           | Main motor power         | kw     | 22 (30)                            |        |         |
| FEEDS     | Number of feeds          |        | 160                                |        |         |
|           | Longitudinal feed range  | mm/rev | 0,032 – 38,9                       |        |         |
|           | Cross feed range         | mm/rev | 0,016 – 19,45                      |        |         |
| THREADS   | Number of threads        |        | 80 of each kind                    |        |         |
|           | Metric thread range      | mm     | 0,5 – 480                          |        |         |
|           | Inch thread range        | Tpi    | 60 – 1/16                          |        |         |
|           | Module thread range      | Module | 0,125 – 120                        |        |         |
|           | DP thread range          | DP     | 240 – ¼                            |        |         |
| CARRIAGE  | Cross slide travel       | mm     | 525                                | 685    |         |
|           | Top slide travel         | mm     | 270                                |        |         |
| TAILSTOCK | Quill diameter           | mm     | 125                                |        |         |
|           | Quill taper              | Morse  | No.6                               |        |         |
|           | Quill travel             | mm     | 260                                |        |         |
| WEIGHT    | For DBC 3000 mm          | kg     | 7500                               | 8050   | 8450    |

\* With option machine bed gap

# CU325RD



For illustration purpose only



# UNIVERSAL LATHES WITH VARIABLE SPINDLE SPEED CONTROL

## STANDARD MACHINE SPECIFICATIONS

## CU325RD

| STANDARD MACHINE SPECIFICATIONS |                                |        | CU325RD                             |
|---------------------------------|--------------------------------|--------|-------------------------------------|
| CAPACITY                        | Height of centers              | mm     | 165                                 |
|                                 | Swing over bed                 | mm     | 325                                 |
|                                 | Swing over cross slide         | mm     | 190                                 |
|                                 | Swing in gap – only DBC1000mm* | mm     | 440                                 |
|                                 | Width of bed                   | mm     | 200                                 |
| SPINDLE                         | Distance between centers       | mm     | 500; 750; 1000                      |
|                                 | Spindle nose DIN 55027         | No     | 5                                   |
|                                 | Spindle bore                   | mm     | 32                                  |
| HEADSTOCK                       | Spindle taper                  | Morse  | No. 4,5                             |
|                                 | Number of spindle speeds       |        | Infinitely variable in 2 sub-ranges |
|                                 | Spindle speed ranges           | rpm    | 85 - 405; 470 – 2200                |
| FEEDS                           | Main motor power               | kw     | 2,2                                 |
|                                 | Number of feeds                |        | 48                                  |
|                                 | Longitudinal feed range        | mm/rev | 0,006 – 1,77                        |
| THREADS                         | Cross feed range               | mm/rev | 0,003 – 0,885                       |
|                                 | Number of threads              |        | As below                            |
|                                 | Metric thread range            | mm     | ( 48 ) 0,1 – 28                     |
|                                 | Inch thread range              | Tpi    | ( 53 ) 75 – 2,5                     |
|                                 | Module thread range            | Module | ( 19 ) 0,1 – 1,75                   |
| CARRIAGE                        | DP thread range                | DP     | ( 19 ) 70 – 4                       |
|                                 | Cross slide travel             | mm     | 150                                 |
|                                 | Top slide travel               | mm     | 95                                  |
| TAILSTOCK                       | Quill diameter                 | mm     | 40                                  |
|                                 | Quill taper                    | Morse  | No.3                                |
|                                 | Quill travel                   | mm     | 100                                 |
| WEIGHT                          | For DBC 1000 mm                | kg     | 770                                 |

\* With option machine bed gap



# C400TS



For illustration purpose only



## UNIVERSAL LATHES WITH VARIABLE SPINDLE SPEED CONTROL

### STANDARD MACHINE SPECIFICATIONS

| STANDARD MACHINE SPECIFICATIONS |                          |        | C400TS                              |
|---------------------------------|--------------------------|--------|-------------------------------------|
| CAPACITY                        | Height of centers        | mm     | 200                                 |
|                                 | Swing over bed           | mm     | 400                                 |
|                                 | Swing over cross slide   | mm     | 235                                 |
|                                 | Swing in gap*            | mm     | 550                                 |
|                                 | Width of bed             | mm     | 320                                 |
| SPINDLE                         | Distance between centers | mm     | 750; 1000; 1500                     |
|                                 | Spindle nose DIN 55027   | No     | 6                                   |
|                                 | Spindle bore             | mm     | 52                                  |
| HEADSTOCK                       | Spindle taper            | Morse  | 6                                   |
|                                 | Number of spindle speeds |        | Infinitely variable in 4 sub-ranges |
|                                 | Spindle speed ranges     | rpm    | 18-98; 48-265; 144-790; 385-2120    |
| FEEDS                           | Main motor power         | kw     | 7,5                                 |
|                                 | Number of feeds          |        | 80                                  |
|                                 | Longitudinal feed range  | mm/rev | 0,015 – 0,6                         |
| THREADS                         | Cross feed range         | mm/rev | 0,0075 – 0,3                        |
|                                 | Number of threads        |        | 40 of each kind                     |
|                                 | Metric thread range      | mm     | 0,25 – 7,5                          |
|                                 | Inch thread range        | Tpi    | 120 – 4                             |
|                                 | Module thread range      | Module | 0,0625 – 1,875                      |
| CARRIAGE                        | DP thread range          | DP     | 480 – 16                            |
|                                 | Cross slide travel       | mm     | 235                                 |
|                                 | Top slide travel         | mm     | 110                                 |
| TAILSTOCK                       | Quill diameter           | mm     | 60                                  |
|                                 | Quill taper              | Morse  | No.4                                |
|                                 | Quill travel             | mm     | 100                                 |
| WEIGHT                          | For DBC 1500 mm          | kg     | 1700                                |

\* With option machine bed gap

## CU400MRD/ CU500MRD/ CU580MRD



For illustration purpose only



## UNIVERSAL LATHES WITH VARIABLE SPINDLE SPEED CONTROL

### STANDARD MACHINE SPECIFICATIONS

|              |                                  |                | CU400MRD                            | CU500MRD | CU580MRD |
|--------------|----------------------------------|----------------|-------------------------------------|----------|----------|
| CAPACITY     | Height of centers                | mm             | 220                                 | 250      | 290      |
|              | Swing over bed                   | mm             | 440                                 | 500      | 580      |
|              | Swing over cross slide           | mm             | 240                                 | 300      | 380      |
|              | Swing in gap - Only DBC 1000 mm* | mm             | 640                                 | 700      | 780      |
|              | Width of bed                     | mm             | 400                                 |          |          |
| SPINDLE      | Distance between centers         | mm             | 1000; 1500; 2000; 3000; 4000; 5000  |          |          |
|              | Spindle nose DIN 55027           | No             | 8                                   |          |          |
|              | Spindle bore                     | mm             | 80                                  |          |          |
|              | Spindle taper                    | Metric         | 80                                  |          |          |
| HEADSTOCK    | Number of spindle speeds         |                | Infinitely variable in 3 sub-ranges |          |          |
|              | Spindle speed ranges             | rpm            | 25 - 100; 100 - 400; 500 - 2000     |          |          |
|              | Main motor power                 | kw             | 11                                  |          |          |
| FEEDS        | Number of feeds                  |                | 120                                 |          |          |
|              | Longitudinal feed range          | mm/rev         | 0,04 - 12                           |          |          |
|              | Cross feed range                 | mm/rev         | 0,02 - 6                            |          |          |
| THREADS      | Number of threads                |                | 64 of each kind                     |          |          |
|              | Metric thread range              | mm             | 0,5 - 120                           |          |          |
|              | Inch thread range                | Tpi            | 60 - 1/4                            |          |          |
|              | Module thread range              | Module         | 0,125 - 30                          |          |          |
|              | DP thread range                  | DP             | 240 - 1                             |          |          |
| CARRIAGE     | Cross slide travel               | mm             | 315                                 |          |          |
|              | Top slide travel                 | mm             | 130                                 |          |          |
|              | TAILSTOCK                        | Quill diameter | mm                                  | 90       |          |
| Quill taper  |                                  | Morse          | No.5                                |          |          |
| Quill travel |                                  | mm             | 230                                 |          |          |
| WEIGHT       | For DBC 2000 mm                  | kg             | 2900                                | 2950     | 3010     |

\* With option machine bed gap

# C11MCS

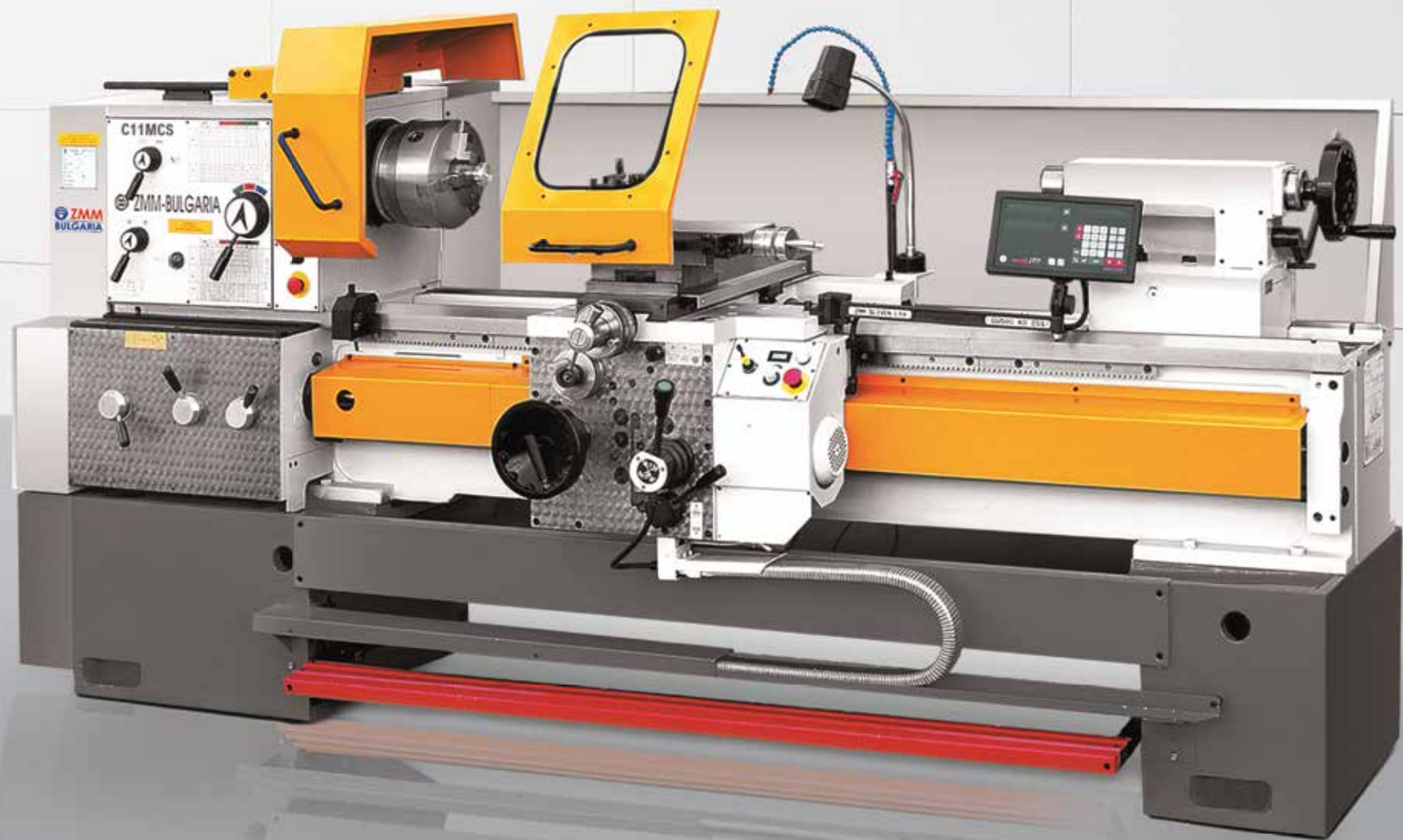

For illustration purpose only



# UNIVERSAL LATHES WITH VARIABLE SPINDLE SPEED CONTROL

## STANDARD MACHINE SPECIFICATIONS

## C11MCS

|           |                                   |        |                                     |
|-----------|-----------------------------------|--------|-------------------------------------|
| CAPACITY  | Height of centers                 | mm     | 300                                 |
|           | Swing over bed                    | mm     | 600                                 |
|           | Swing over cross slide            | mm     | 400                                 |
|           | Swing in gap*                     | mm     | 800                                 |
|           | Width of bed                      | mm     | 400                                 |
| SPINDLE   | Distance between centers          | mm     | 1000; 1500; 2000; 3000; 4000; 5000  |
|           | Spindle nose DIN 55027            | No     | 8                                   |
|           | Spindle bore                      | mm     | 80                                  |
| HEADSTOCK | Spindle taper                     | Metric | 90                                  |
|           | Number of spindle speeds          |        | Infinitely variable in 3 sub-ranges |
|           | Spindle variable speed sub-ranges | rpm    | 20 - 100; 80 - 400; 400 - 2000      |
| FEEDS     | Main motor power                  | kw     | 11                                  |
|           | Number of feeds                   |        | 120                                 |
|           | Longitudinal feed range           | mm/rev | 0,04 – 12                           |
| THREADS   | Cross feed range                  | mm/rev | 0,02 – 6                            |
|           | Number of threads                 |        | 64                                  |
|           | Metric thread range               | mm     | 0,5 – 120                           |
|           | Inch thread range                 | Tpi    | 60 – 1/4                            |
|           | Module thread range               | Module | 0,125 – 30                          |
| CARRIAGE  | DP thread range                   | DP     | 240 – 1                             |
|           | Cross slide travel                | mm     | 315                                 |
|           | Top slide travel                  | mm     | 130                                 |
| TAILSTOCK | Quill diameter                    | mm     | 90                                  |
|           | Quill taper                       | Morse  | No.5                                |
|           | Quill travel                      | mm     | 230                                 |
| WEIGHT    | For DBC 2000 mm                   | kg     | 3110                                |

\* With option machine bed gap

## CU500MTRD/ CU630RD/ CU730RD



For illustration purpose only

CE

## UNIVERSAL LATHES WITH VARIABLE SPINDLE SPEED CONTROL

### STANDARD MACHINE SPECIFICATIONS

|           |                                  |        | CU500MTRD                           | CU630RD                 | CU730RD |
|-----------|----------------------------------|--------|-------------------------------------|-------------------------|---------|
| CAPACITY  | Height of centers                | mm     | 250                                 | 315                     | 365     |
|           | Swing over bed                   | mm     | 500                                 | 630                     | 730     |
|           | Swing over cross slide           | mm     | 300                                 | 430                     | 500     |
|           | Swing in gap - Only DBC 1000 mm* | mm     | 700                                 | 830                     | 930     |
|           | Width of bed                     | mm     | 400                                 |                         |         |
|           | Distance between centers         | mm     | 1000; 1500; 2000; 3000; 4000; 5000  |                         |         |
| SPINDLE   | Spindle nose DIN 55027           | No     | 11                                  |                         |         |
|           | Spindle bore                     | mm     | 103                                 |                         |         |
|           | Spindle taper                    | Metric | 120                                 |                         |         |
| HEADSTOCK | Number of spindle speeds         |        | Infinitely variable in 3 sub-ranges |                         |         |
|           | Spindle speed ranges             | rpm    | 16-63; 63-250; 355-1400             | 16-63; 63-250; 315-1250 |         |
|           | Main motor power                 | kw     | 11                                  |                         |         |
| FEEDS     | Number of feeds                  |        | 120                                 |                         |         |
|           | Longitudinal feed range          | mm/rev | 0,04 – 12                           |                         |         |
|           | Cross feed range                 | mm/rev | 0,02 – 6                            |                         |         |
| THREADS   | Number of threads                |        | 64 of each kind                     |                         |         |
|           | Metric thread range              | mm     | 0,5 – 120                           |                         |         |
|           | Inch thread range                | Tpi    | 60 – 1/4                            |                         |         |
|           | Module thread range              | Module | 0,125 – 30                          |                         |         |
|           | DP thread range                  | DP     | 240 – 1                             |                         |         |
| CARRIAGE  | Cross slide travel               | mm     | 315                                 |                         | 390     |
|           | Top slide travel                 | mm     | 130                                 |                         |         |
| TAILSTOCK | Quill diameter                   | mm     | 90                                  |                         |         |
|           | Quill taper                      | Morse  | No.5                                |                         |         |
|           | Quill travel                     | mm     | 230                                 |                         |         |
| WEIGHT    | For DBC 2000 mm                  | kg     | 3250                                | 3310                    | 3500    |

\* With option machine bed gap



# C10TS/ C10TMS/ C10THS



For illustration purpose only



# UNIVERSAL LATHES WITH VARIABLE SPINDLE SPEED CONTROL

## STANDARD MACHINE SPECIFICATIONS

|           |                                  |        | C10TS                               | C10TMS                           | C10THS       |
|-----------|----------------------------------|--------|-------------------------------------|----------------------------------|--------------|
| CAPACITY  | Height of centers                | mm     | 330                                 | 380                              | 430          |
|           | Swing over bed                   | mm     | 660                                 | 760                              | 860          |
|           | Swing over cross slide           | mm     | 420                                 | 520                              | 620          |
|           | Swing in gap - Only DBC 1000 mm* | mm     | 850                                 | 950                              | 1050         |
|           | Width of bed                     | mm     | 560                                 |                                  |              |
|           | Distance between centers         | mm     | 1500; 2000; 3000; 4000; 5000; 6000  |                                  |              |
| SPINDLE   | Spindle nose DIN 55027           | No     | 11                                  |                                  |              |
|           | Spindle bore                     | mm     | 103                                 | 132                              |              |
|           | Spindle taper                    | Metric | 120                                 | 140                              |              |
| HEADSTOCK | Number of spindle speeds         |        | Infinitely variable in 3 sub-ranges |                                  |              |
|           | Spindle speed ranges             | rpm    | 12,5 - 82,5; 50 - 375; 200 - 1320   | 12,5 - 100; 50 - 415; 150 - 1250 |              |
|           | Main motor power                 | kw     | 15                                  | 15 (18,5)                        | 18,5         |
| FEEDS     | Number of feeds                  |        | 160                                 |                                  |              |
|           | Longitudinal feed range          | mm/rev | 0,039 – 18                          |                                  |              |
|           | Cross feed range                 | mm/rev | 0,02 – 9                            |                                  |              |
| THREADS   | Number of threads                |        | 64 of each kind                     |                                  |              |
|           | Metric thread range              | mm     | 0,5 – 120                           |                                  | 0,5 - 90     |
|           | Inch thread range                | Tpi    | 60 – 1/4                            |                                  | 60 - 1/3     |
|           | Module thread range              | Module | 0,125 – 30                          |                                  | 0,125 - 22,5 |
|           | DP thread range                  | DP     | 240 – 1                             |                                  | 240 - 1 1/3  |
| CARRIAGE  | Cross slide travel               | mm     | 410                                 |                                  | 432          |
|           | Top slide travel                 | mm     | 150                                 |                                  |              |
| TAILSTOCK | Quill diameter                   | mm     | 105                                 |                                  |              |
|           | Quill taper                      | Morse  | No.6                                |                                  |              |
|           | Quill travel                     | mm     | 225                                 |                                  |              |
| WEIGHT    | For DBC 2000 mm                  | kg     | 4170                                | 4470                             | 4650         |

\* With option machine bed gap

# CU800RD/ CU1000RD/ CU1250RD



For illustration purpose only



# UNIVERSAL LATHES WITH VARIABLE SPINDLE SPEED CONTROL

## STANDARD MACHINE SPECIFICATIONS

|           |                          |        | CU800RD  | CU1000RD | CU1250RD |
|-----------|--------------------------|--------|--|----------|----------|
| CAPACITY  | Height of centers        | mm     | 400  | 500      | 625      |
|           | Swing over bed           | mm     | 890  | 1090     | 1320     |
|           | Swing over cross slide   | mm     | 490  | 690      | 940      |
|           | Swing in gap*            | mm     | 1050   | 1250     | 1500     |
|           | Width of bed             | mm     | 700  |          |          |
|           | Distance between centers | mm     | 1500;2000;3000;4000;5000;6000;7000;8000;9000;10000 |          |          |
| SPINDLE   | Spindle nose DIN 55027   | No     | 15   |          |          |
|           | Spindle bore             | mm     | 155  |          |          |
|           | Spindle taper            | Metric | 160  |          |          |
| HEADSTOCK | Number of spindle speeds |        | Infinitely variable in 4 sub-ranges                |          |          |
|           | Spindle speed ranges     | rpm    | 3,7-15,6; 14,7-62; 58-250; 235-1000                |          |          |
|           | Main motor power         | kw     | 30   |          |          |
| FEEDS     | Number of feeds          |        | 160  |          |          |
|           | Longitudinal feed range  | mm/rev | 0,032 – 38,9                                       |          |          |
|           | Cross feed range         | mm/rev | 0,016 – 19,45                                      |          |          |
| THREADS   | Number of threads        |        | 80 of each kind                                    |          |          |
|           | Metric thread range      | mm     | 0,5 – 480  |          |          |
|           | Inch thread range        | Tpi    | 60 – 1/16  |          |          |
|           | Module thread range      | Module | 0,125 – 120  |          |          |
|           | DP thread range          | DP     | 240 – ¼  |          |          |
| CARRIAGE  | Cross slide travel       | mm     | 525  |          | 685      |
|           | Top slide travel         | mm     | 270  |          |          |
| TAILSTOCK | Quill diameter           | mm     | 125  |          |          |
|           | Quill taper              | Morse  | No.6   |          |          |
|           | Quill travel             | mm     | 260  |          |          |
| WEIGHT    | For DBC 3000 mm          | kg     | 7500   | 8050     | 8450     |

\* With option machine bed gap

# CU1410RD



For illustration purpose only



# UNIVERSAL LATHES WITH VARIABLE SPINDLE SPEED CONTROL

## STANDARD MACHINE SPECIFICATIONS

## CU1410RD

|           |                          |        |  |
|-----------|--------------------------|--------|--|
| CAPACITY  | Height of centers        | mm     | 705  |
|           | Swing over bed           | mm     | 1410   |
|           | Swing over cross slide   | mm     | 1000   |
|           | Width of bed             | mm     | 800  |
|           | Distance between centers | mm     | 2000; 3000; 4000; 5000; 6000; 7000; 8000; 9000 |
| SPINDLE   | Spindle nose DIN 55026   | No     | A 15   |
|           | Spindle bore             | mm     | 205  |
|           | Spindle taper            | Metric | 215  |
| HEADSTOCK | Number of spindle speeds |        | Infinitely variable in 4 sub-ranges            |
|           | Spindle speed ranges     | rpm    | 1,5-8; 5-31; 20-125; 80-500                    |
|           | Main motor power         | kw     | 45   |
| FEEDS     | Number of feeds          |        | 160  |
|           | Longitudinal feed range  | mm/rev | 0,032 – 38,9                                   |
|           | Cross feed range         | mm/rev | 0,016 – 19,45                                  |
| THREADS   | Number of threads        |        | 80 of each kind                                |
|           | Metric thread range      | mm     | 0,5 – 480                                      |
|           | Inch thread range        | Tpi    | 60 – 1/16                                      |
|           | Module thread range      | Module | 0,125 – 120                                    |
|           | DP thread range          | DP     | 240 – ¼  |
| CARRIAGE  | Cross slide travel       | mm     | 730  |
|           | Top slide travel         | mm     | 350  |
| TAILSTOCK | Quill diameter           | mm     | 200  |
|           | Quill taper              | Morse  | No.7   |
|           | Quill travel             | mm     | 300  |
| WEIGHT    | For DBC 3000 mm          | kg     | 14000  |

# C11T.6/ C10T.10/ C10T.12



For illustration purpose only



# OIL COUNTRY LATHES

## STANDARD MACHINE SPECIFICATIONS

|           |                                 |                 | C11T.6                   | C10T.10                       | C10T.12 |
|-----------|---------------------------------|-----------------|--------------------------|-------------------------------|---------|
| CAPACITY  | Height of centers               | mm              | 365                      | 400                           |         |
|           | Swing over bed                  | mm              | 730                      | 800                           |         |
|           | Swing over cross slide          | mm              | 500                      | 560                           |         |
|           | Swing in gap                    | mm              | 930*                     | 990                           |         |
|           | Width of bed                    | mm              | 400                      | 560                           |         |
|           | Distance between centers        | mm              | 1500;2000;3000;4000;5000 | 1500;2000;3000;4000;5000;6000 |         |
| SPINDLE   | Spindle nose DIN 55026 ASA B5.9 | No              | A15 – A2.15              | A20 – A2.20                   |         |
|           | Spindle bore                    | mm              | 155                      | 315                           |         |
|           | Spindle taper                   | Metric          | 160                      | 318                           |         |
| HEADSTOCK | Number of spindle speeds        |                 | 12                       |                               |         |
|           | Spindle speed ranges            | rpm             | 16-800                   | 8-400                         |         |
|           | Main motor power                | kw              | 11                       | 11 (15)                       |         |
| FEEDS     | Number of feeds                 |                 | 152                      |                               |         |
|           | Longitudinal feed range         | mm/rev          | 0,039 – 9                | 0,039 – 15                    |         |
|           | Cross feed range                | mm/rev          | 0,02 – 4,5               | 0,02 – 7,5                    |         |
| THREADS   | Number of threads               |                 | 76 of each kind          |                               |         |
|           | Metric thread range             | mm              | 0,5 – 90                 | 0,5 – 150                     |         |
|           | Inch thread range               | Tpi             | 60 – 1/3                 | 60 – 1/5                      |         |
|           | Module thread range             | Module          | 0,125 – 22,5             | 0,125 – 37,5                  |         |
|           | DP thread range                 | DP              | 240 – 1 1/3              | 240 – 4/5                     |         |
| CARRIAGE  | Cross slide travel              | mm              | 390                      | 410                           |         |
|           | Top slide travel                | mm              | 130                      | 150                           |         |
|           | Quill diameter                  | mm              | 90                       | 105                           |         |
| TAILSTOCK | Quill taper                     | Morse           | No.5                     | No.6                          |         |
|           | Quill travel                    | mm              | 225                      |                               |         |
|           | WEIGHT                          | For DBC 2000 mm | kg                       | 4300                          | 6000    |

# C10T.14



For illustration purpose only



# OIL COUNTRY LATHES

## STANDARD MACHINE SPECIFICATIONS

| STANDARD MACHINE SPECIFICATIONS |                                 |        | C10T.14                            |
|---------------------------------|---------------------------------|--------|------------------------------------|
| CAPACITY                        | Height of centers               | mm     | 510                                |
|                                 | Swing over bed                  | mm     | 1020                               |
|                                 | Swing over cross slide          | mm     | 770                                |
|                                 | Swing in gap*                   | mm     | 1200                               |
|                                 | Width of bed                    | mm     | 560                                |
|                                 | Distance between centers        | mm     | 1500; 2000; 3000; 4000; 5000; 6000 |
| SPINDLE                         | Spindle nose DIN 55026 ASA B5.9 | No     | A20 – A2.20                        |
|                                 | Spindle bore                    | mm     | 358                                |
|                                 | Spindle taper                   | Metric | 361                                |
| HEADSTOCK                       | Number of spindle speeds        |        | 12                                 |
|                                 | Spindle speed ranges            | rpm    | 6,3 - 315                          |
|                                 | Main motor power                | kw     | 18,5                               |
| FEEDS                           | Number of feeds                 |        | 152                                |
|                                 | Longitudinal feed range         | mm/rev | 0,039 – 15                         |
|                                 | Cross feed range                | mm/rev | 0,02 – 7,5                         |
| THREADS                         | Number of threads               |        | 76 of each kind                    |
|                                 | Metric thread range             | mm     | 0,5 – 150                          |
|                                 | Inch thread range               | Tpi    | 60 – 1/5                           |
|                                 | Module thread range             | Module | 0,125 – 37,5                       |
|                                 | DP thread range                 | DP     | 240 – 4/5                          |
| CARRIAGE                        | Cross slide travel              | mm     | 505                                |
|                                 | Top slide travel                | mm     | 270                                |
| TAILSTOCK                       | Quill diameter                  | mm     | 105                                |
|                                 | Quill taper                     | Morse  | No.6                               |
|                                 | Quill travel                    | mm     | 225                                |
| WEIGHT                          | For DBC 2000 mm                 | kg     | 6400                               |

\* With option machine bed gap

# C10T.10S/ C10T.12S/ C10T.14S



For illustration purpose only



# OIL COUNTRY LATHES WITH VARIABLE SPINDLE SPEED CONTROL

## STANDARD MACHINE SPECIFICATIONS

|                   |                          |        | C10T.10S                      | C10T.12S | C10T.14S |
|-------------------|--------------------------|--------|-------------------------------|----------|----------|
| CAPACITY          | Height of centers        | mm     | 400                           | 510      |          |
|                   | Swing over bed           | mm     | 800                           | 1020     |          |
|                   | Swing over cross slide   | mm     | 560                           | 770      |          |
|                   | Swing in gap*            | mm     | 990                           | 1200     |          |
|                   | Distance between centers | mm     | 1500,2000,3000,4000,5000,6000 |          |          |
| SPINDLE           | Spindle nose DIN 55026   | No     | A 20 – A2 20                  |          |          |
|                   | Front bearing diameter   | mm     | 380                           | 420      |          |
|                   | Spindle bore             | mm     | 315                           | 358      |          |
|                   | Spindle taper            | Metric | 318                           | 361      |          |
| HEADSTOCK         | Number of spindle speeds |        | 4                             |          |          |
|                   | I - Range                | rpm    | 8-40                          | 5-20     |          |
|                   | II - Range               | rpm    | 16-80                         | 15-63    |          |
|                   | III - Range              | rpm    | 40-200                        | 25-100   |          |
|                   | IV - Range               | rpm    | 80-400                        | 80-315   |          |
| TRAVELS AND FEEDS | Number of feeds          |        | 152                           |          |          |
|                   | Longitudinal feed range  | mm/rev | 0.039-15                      |          |          |
|                   | Cross feed range         | mm/rev | 0.02-7.5                      |          |          |
| THREADS           | Number of threads        |        | 76                            |          |          |
|                   | Metric thread range      | mm     | 0.5-150                       |          |          |
|                   | Inch thread range        | Tpi    | 60 - 1/5                      |          |          |
|                   | Module thread range      | Module | 0.125 - 37.5                  |          |          |
|                   | DP thread range          | DP     | 240 - 4/5                     |          |          |
| CARRIAGE          | Cross slide travel       | mm     | 410                           | 505      |          |
|                   | Top slide travel         | mm     | 150                           | 270      |          |
| TAILSTOCK         | Quill diameter           | mm     | 105                           |          |          |
|                   | Quill taper              | Morse  | 6                             |          |          |
|                   | Quill travel             | mm     | 225                           |          |          |
| WEIGHT            | For DBC 3000 mm          | kg     | 6580                          | 6680     | 6980     |

\* With option machine bed gap

# LT580



For illustration purpose only



# CNC LATHES

## STANDARD MACHINE SPECIFICATIONS

## LT580

|                   |                               |        |                                    |
|-------------------|-------------------------------|--------|------------------------------------|
| CAPACITY          | Height of centers             | mm     | 290                                |
|                   | Swing over bed                | mm     | 580                                |
|                   | Swing over cross slide        | mm     | 380                                |
|                   | Width of bed                  | mm     | 400                                |
|                   | Distance between centers      | mm     | 1000; 1500; 2000; 3000; 4000; 5000 |
| SPINDLE           | Spindle nose DIN 55027        | No     | 8                                  |
|                   | Front bearing diameter        | mm     | 120                                |
|                   | Spindle bore                  | mm     | 72                                 |
|                   | Spindle taper                 | Metric | 80                                 |
| HEADSTOCK         | Number of spindle speed       |        | 3                                  |
|                   | I-Range                       | rpm    | 25 – 100                           |
|                   | II-Range                      | rpm    | 100 - 400                          |
|                   | III-Range                     | rpm    | 500 - 2000                         |
| TRAVELS AND FEEDS | Longitudinal feed (Z-axis)    | m/min  | 8 (max)                            |
|                   | Lateral feed (X-axis)         | m/min  | 8 (max)                            |
|                   | Rapid traverse (Z and X-axis) | m/min  | 8 (max)                            |
|                   | Cross slide maximum travel    | mm     | 290                                |
| BALL SCREW        | Z-axis                        | mm     | 50x10                              |
|                   | X-axis                        | mm     | 32x5                               |
| TAILSTOCK         | Quill Diameter                | mm     | 90                                 |
|                   | Quill Travel                  | mm     | 230                                |
|                   | Quill internal taper          | Morse  | 5                                  |
| DRIVES            | Main drive power              | kW     | 11kW ( AT160M4 )                   |
|                   | Z-axis servo drive power      | kW/N.m | 3,1kW (20 N.m)                     |
|                   | X-axis servo drive power      | kW/N.m | 1,9kW (11 N.m)                     |
|                   | Spindle maximum torque        | N.m    | 1120                               |
|                   | Z-axis tow strength           | daN    | 1450                               |
|                   | X-axis tow strength           | daN    | 1050                               |
| TOOL HOLDER       | Quick change type             |        | MC                                 |
| CNC SYSTEM        |                               |        | Siemens                            |
| WEIGHT            | For DBC 2000 mm               | kg     | 3800                               |

CNC System and servo drives available also: Heidenhain; Fanuc; Fagor

# LT660/ LT760/ LT860



For illustration purpose only

# CNC LATHES

## STANDARD MACHINE SPECIFICATIONS

|                   |                               |        | LT660                              | LT760      | LT860 |
|-------------------|-------------------------------|--------|------------------------------------|------------|-------|
| CAPACITY          | Height of centers             | mm     | 330                                | 380        | 430   |
|                   | Swing over bed                | mm     | 660                                | 760        | 860   |
|                   | Swing over cross slide        | mm     | 420                                | 520        | 620   |
|                   | Width of bed                  | mm     | 560                                |            |       |
|                   | Distance between centers      | mm     | 1500; 2000; 3000; 4000; 5000; 6000 |            |       |
| SPINDLE           | Spindle nose DIN 55027        | No     | 11                                 |            |       |
|                   | Front bearing diameter        | mm     | 140                                | 170        |       |
|                   | Spindle bore                  | mm     | 103                                | 132        |       |
|                   | Spindle taper                 | Metric | 120                                | 140        |       |
| HEADSTOCK         | Number of spindle speed       |        | 3                                  |            |       |
|                   | I-Range                       | rpm    | 15 – 100                           | 15 - 130   |       |
|                   | II-Range                      | rpm    | 60 - 400                           | 50 - 450   |       |
|                   | III-Range                     | rpm    | 195 - 1320                         | 150 - 1250 |       |
| TRAVELS AND FEEDS | Longitudinal feed (Z-axis)    | m/min  | 8 (max)                            |            |       |
|                   | Lateral feed (X-axis)         | m/min  | 8 (max)                            |            |       |
|                   | Rapid traverse (Z and X-axis) | m/min  | 8 (max)                            |            |       |
|                   | Cross slide maximum travel    | mm     | 430                                |            |       |
| BALL SCREW        | Z-axis                        | mm     | 50x10                              |            |       |
|                   | X-axis                        | mm     | 32x5                               |            |       |
| TAILSTOCK         | Quill Diameter                | mm     | 105                                |            |       |
|                   | Quill Travel                  | mm     | 225                                |            |       |
|                   | Quill internal taper          | Morse  | 6                                  |            |       |
| DRIVES            | Main drive power              | kW     | 15Kw                               | 18,5kW     |       |
|                   | Z-axis servo drive power      | kW/N.m | 3kW (18 N.m)                       |            |       |
|                   | X-axis servo drive power      | kW/N.m | 1,9kW (11 N.m)                     |            |       |
|                   | Spindle maximum torque        | N.m    | 2000                               | 2250       |       |
|                   | Z-axis tow strength           | daN    | 1250                               |            |       |
|                   | X-axis tow strength           | daN    | 1050                               |            |       |
| TOOL HOLDER       | Quick change type             |        | MC                                 |            |       |
| CNC SYSTEM        |                               |        | Siemens                            |            |       |
| WEIGHT            | For DBC 3000 mm               | kg     | 5700                               | 6060       | 6300  |

CNC System and servo drives also available from: Heidenhain;Fanuc;Fagor



# LTC10T.10/ LTC10T.12



For illustration purpose only



# CNC LATHES

## STANDARD MACHINE SPECIFICATIONS

|                   |                               |        | LTC10T.10                     | LTC10T.12 |
|-------------------|-------------------------------|--------|-------------------------------|-----------|
| CAPACITY          | Height of centers             | mm     | 400                           |           |
|                   | Swing over bed                | mm     | 800                           |           |
|                   | Swing over cross slide        | mm     | 560                           |           |
|                   | Width of bed                  | mm     | 560                           |           |
|                   | Distance between centers      | mm     | 1500;2000;3000;4000;5000;6000 |           |
| SPINDLE           | Spindle nose DIN 55026        | No     | A 20 / A2 20                  |           |
|                   | Front bearing diameter        | mm     | 380                           |           |
|                   | Spindle bore                  | mm     | 315                           |           |
|                   | Number of spindle speeds      |        | 4                             |           |
| HEADSTOCK         | I - Range                     | rpm    | 8 – 40                        |           |
|                   | II - Range                    | rpm    | 16 – 80                       |           |
|                   | III - Range                   | rpm    | 40 - 200                      |           |
|                   | IV - Range                    | rpm    | 80 - 400                      |           |
| TRAVELS AND FEEDS | Longitudinal feed (Z-axis)    | m/min  | 8 (max)                       |           |
|                   | Lateral feed (X-axis)         | m/min  | 8 (max)                       |           |
|                   | Rapid traverse (Z and X-axis) | m/min  | 8 (max)                       |           |
|                   | Cross slide maximum travel    | mm     | 390                           |           |
| BALL SCREW        | Z-axis                        | mm     | 50x10                         |           |
|                   | X-axis                        | mm     | 32x5                          |           |
| TAILSTOCK         | Quill diameter                | mm     | 105                           |           |
|                   | Quill travel                  | mm     | 225                           |           |
|                   | Quill taper                   | Morse  | 6                             |           |
| DRIVES            | Main drive power              | kW     | 18,5kW                        |           |
|                   | Z-axis servo drive power      | kW/N.m | 3kW (18 N.m)                  |           |
|                   | X-axis servo drive power      | kW/N.m | 1,9kW (11 N.m)                |           |
|                   | Spindle maximum torque        | N.m    | 3500                          |           |
|                   | Z-axis tow strength           | daN    | 1250                          |           |
|                   | X-axis tow strength           | daN    | 1050                          |           |
| TOOL HOLDER       | Quick change type             |        | MC                            |           |
| CNC SYSTEM        |                               |        | Siemens                       |           |
| WEIGHT            | For DBC 3000 mm               | kg     | 6680                          |           |

CNC System and servo drives also available from: Heidenhain; Fanuc; Fagor



# LT C10T.14/ LT C10T.14M



For illustration purpose only



# CNC LATHES

## STANDARD MACHINE SPECIFICATIONS

## LTC10T.14/ LTC10T.14M

|                   |                               |           |                               |
|-------------------|-------------------------------|-----------|-------------------------------|
| CAPACITY          | Height of centers             | mm        | 510                           |
|                   | Swing over bed                | mm        | 1020                          |
|                   | Swing over cross slide        | mm        | 770                           |
|                   | Width of bed                  | mm        | 560                           |
|                   | Distance between centers      | mm        | 1500;2000;3000;4000;5000;6000 |
| SPINDLE           | Spindel nose DIN 55026        | No        | A 20 - A2 20                  |
|                   | Front bearing diameter        | mm        | 440                           |
|                   | Spindle bore                  | mm        | 358                           |
|                   | Spindel taper                 | Metric    | 361                           |
| HEADSTOCK         | Number of spindel speeds      |           | 4                             |
|                   | I - Range                     | rpm       | 5 - 20                        |
|                   | II - Range                    | rpm       | 15 - 63                       |
|                   | III - Range                   | rpm       | 25 - 100                      |
|                   | IV - Range                    | rpm       | 80 - 315                      |
| TRAVELS AND FEEDS | Longitudinal feed (Z-axis)    | m/min     | 8 (max)                       |
|                   | Lateral feed (X-axis)         | m/min     | 8 (max)                       |
|                   | Rapid traverse (Z and X-axis) | m/min     | 8 (max)                       |
|                   | Cross slide maximum travel    | mm        | 520                           |
|                   | BALL SCREW                    | Z-axis    | mm                            |
| X-axis            |                               | mm        | 32x5                          |
| TAILSTOCK         | Quill diameter                | mm        | 105                           |
|                   | Quill travel                  | mm        | 225                           |
|                   | Quill taper                   | Morse No. | 6                             |
| DRIVES            | Main drive power              | kW        | 22                            |
|                   | Z-axis servo drive power      | kW/N.m    | 3kW (18 N.m)                  |
|                   | X-axis servo drive power      | kW/N.m    | 1.9kW (11 N.m)                |
|                   | Spindle maximum torque        | Nm        | 3500                          |
|                   | Z-axis tow strength           | daN       | 1250                          |
|                   | X-axis tow strength           | daN       | 1050                          |
| TOOL HOLDER       | Quick change type             |           | MD1                           |
| CNC SYSTEM        |                               |           | Siemens                       |
| WEIGHT            | For DBC 3000 mm               | kg        | 6680                          |

CNC System and servo drives also available from: Heidenhain; Fanuc; Fagor

# LT800/ LT1000/ LT1250



For illustration purpose only



## CNC LATHES

### STANDARD MACHINE SPECIFICATIONS

|                   |                               |        | LT800                    | LT1000 | LT1250 |
|-------------------|-------------------------------|--------|--------------------------|--------|--------|
| CAPACITY          | Height of centers             | mm     | 410                      | 510    | 635    |
|                   | Swing over bed                | mm     | 890                      | 1090   | 1320   |
|                   | Swing over cross slide        | mm     | 490                      | 690    | 940    |
|                   | Width of bed                  | mm     | 700                      |        |        |
|                   | Distance between centers      | mm     | 1500;3000;4000;5000;6000 |        |        |
| SPINDLE           | Spindle nose DIN 55027        | No     | 15                       |        |        |
|                   | Front bearing diameter        | mm     | 200                      |        |        |
|                   | Spindle bore                  | mm     | 155                      |        |        |
|                   | Spindle taper                 | Metric | 160                      |        |        |
| HEADSTOCK         | Number of spindle speeds      |        | 4                        |        |        |
|                   | I - Range                     | rpm    | 3,7 – 15,6               |        |        |
|                   | II - Range                    | rpm    | 14,7 – 62                |        |        |
|                   | III - Range                   | rpm    | 58 – 250                 |        |        |
|                   | IV - Range                    | rpm    | 235 - 1000               |        |        |
| TRAVELS AND FEEDS | Longitudinal feed (Z-axis)    | m/min  | 8 (max)                  |        |        |
|                   | Lateral feed (X-axis)         | m/min  | 8 (max)                  |        |        |
|                   | Rapid traverse (Z and X-axis) | m/min  | 8 (max)                  |        |        |
|                   | Cross slide maximum travel    | mm     | 525                      |        | 650    |
| BALL SCREW        | Z-axis                        | mm     | 63x10                    |        |        |
|                   | X-axis                        | mm     | 40x10                    |        |        |
| TAILSTOCK         | Quill diameter                | mm     | 125                      |        |        |
|                   | Quill travel                  | mm     | 250                      |        |        |
|                   | Quill taper                   | Morse  | 6                        |        |        |
| DRIVES            | Main drive power              | kW     | 30kW                     |        |        |
|                   | Z-axis servo drive power      | kW/N.m | 5,2kW (36 N.m)           |        |        |
|                   | X-axis servo drive power      | kW/N.m | 2,6kW (16 N.m)           |        |        |
|                   | Spindle maximum torque        | N.m    | 5000                     |        |        |
|                   | Z-axis tow strength           | daN    | 1600                     |        |        |
|                   | X-axis tow strength           | daN    | 800                      |        |        |
| TOOL HOLDER       | Quick change type             |        | MD1                      |        |        |
| CNC SYSTEM        |                               |        | Siemens                  |        |        |
| WEIGHT            | For DBC 3000 mm               | kg     | 8800                     | 9300   | 9800   |

CNC System and servo drives also available from: Heidenhain; Fanuc; Fagor



# LT1410



For illustration purpose only



# CNC LATHES

## STANDARD MACHINE SPECIFICATIONS

## LT1410

|                   |                               |           |   |
|-------------------|-------------------------------|-----------|---|
| CAPACITY          | Height of centers             | mm        | 705                                     |
|                   | Swing over bed                | mm        | 1410                                    |
|                   | Swing over cross slide        | mm        | 1000                                    |
|                   | Width of bed                  | mm        | 800                                     |
|                   | Distance between centers      | mm        | 2000,3000,4000,5000,6000,7000,8000,9000 |
| SPINDLE           | Spindel nose DIN 55027        | No        | A 15                                    |
|                   | Front bearing diameter        | mm        | 280                                     |
|                   | Spindle bore                  | mm        | 205                                     |
|                   | Spindel taper                 | Metric    | 215                                     |
| HEADSTOCK         | Number of spindel speeds      |           | 4                                       |
|                   | I - Range                     | rpm       | 1,5-8                                   |
|                   | II - Range                    | rpm       | 5-31                                    |
|                   | III - Range                   | rpm       | 20-125                                  |
|                   | IV - Range                    | rpm       | 80-500                                  |
| TRAVELS AND FEEDS | Longitudinal feed (Z-axis)    | m/min     | 8 (max)                                 |
|                   | Lateral feed (X-axis)         | m/min     | 8 (max)                                 |
|                   | Rapid traverse (Z and X-axis) | m/min     | 8 (max)                                 |
|                   | Cross slide maximum travel    | mm        | 725                                     |
|                   | BALL SCREW                    | X-axis    | mm                                      |
| TAILSTOCK         | Quill diameter                | mm        | 200                                     |
|                   | Quill travel                  | mm        | 300                                     |
|                   | Quill taper                   | Morse No. | 7                                       |
| DRIVES            | Main drive power              | kW        | 45                                      |
|                   | Z-axis servo drive power      | kW/N.m    | 7,7kW (48 N.m)                          |
|                   | X-axis servo drive power      | kW/N.m    | 2,3kW (11 N.m)                          |
|                   | Spindle maximum torque        | Nm        | 7000                                    |
|                   | Z-axis tow strength           | daN       | 2800                                    |
|                   | X-axis tow strength           | daN       | 2000                                    |
| TOOL HOLDER       | Quick change type             | Parat No. | 5                                       |
| CNC SYSTEM        |                               |           | Siemens                                 |
| WEIGHT            | For DBC 3000 mm               | kg        | 14800                                   |

CNC System and servo drives also available from: Heidenhain; Fanuc; Fagor

# LCC800/ LCC1000/ LCC1250



For illustration purpose only



## CNC LATHES

### STANDARD MACHINE SPECIFICATIONS

|                   |                               |        | LCC800                       | LCC1000 | LCC1250 |
|-------------------|-------------------------------|--------|------------------------------|---------|---------|
| CAPACITY          | Height of centers             | mm     | 410                          | 510     | 635     |
|                   | Swing over bed                | mm     | 890                          | 1090    | 1320    |
|                   | Swing over cross slide        | mm     | 490                          | 690     | 940     |
|                   | Width of bed                  | mm     | 700                          |         |         |
|                   | Distance between centers      | mm     | 1500; 3000; 4000; 5000; 6000 |         |         |
| SPINDLE           | Spindle nose DIN 55027        | No     | 15                           |         |         |
|                   | Front bearing diameter        | mm     | 200                          |         |         |
|                   | Spindle bore                  | mm     | 155                          |         |         |
|                   | Spindle taper                 | Metric | 160                          |         |         |
| HEADSTOCK         | Number of spindle speeds      |        | 2                            |         |         |
|                   | I - Range                     | rpm    | 2 - 180                      |         |         |
|                   | II - Range                    | rpm    | 8 - 700                      |         |         |
| TRAVELS AND FEEDS | Longitudinal feed (Z-axis)    | m/min  | 8 (max)                      |         |         |
|                   | Lateral feed (X-axis)         | m/min  | 8 (max)                      |         |         |
|                   | Rapid traverse (Z and X-axis) | m/min  | 8 (max)                      |         |         |
|                   | Cross slide maximum travel    | mm     | 525                          |         | 650     |
|                   | BALL SCREW                    | Z-axis | mm                           | 63 x 10 |         |
| X-axis            |                               | mm     | 40 x 10                      |         |         |
| TAILSTOCK         | Quill diameter                | mm     | 125                          |         |         |
|                   | Quill travel                  | mm     | 250                          |         |         |
|                   | Quill taper                   | Morse  | 6                            |         |         |
| DRIVES            | Main drive power              | kW     | 30kW                         |         |         |
|                   | Z-axis servo drive power      | kW/N.m | 4,4kW (36 N.m)               |         |         |
|                   | X-axis servo drive power      | kW/N.m | 3,3kW (16 N.m)               |         |         |
|                   | Spindle maximum torque        | N.m    | 5000                         |         |         |
|                   | Z-axis tow strength           | daN    | 1600                         |         |         |
|                   | X-axis tow strength           | daN    | 1000                         |         |         |
| TOOL HOLDER       | Quick change type             |        | MD1                          |         |         |
| CNC SYSTEM        |                               |        | Siemens                      |         |         |
| WEIGHT            | For DBC 3000 mm               | kg     | 8800                         | 9300    | 9800    |

CNC System and servo drives also available from: Heidenhain; Fanuc; Fagor

# NEW CYCLIC LATHE LS 600M

The LS 600M boasts remarkable technical characteristics that set it apart from traditional lathes. Equipped with a three-speed gearbox, it offers unparalleled balance between torque and speed, ensuring optimal performance across various machining processes. The utilization of reputable drives, controllers, and CNC systems guarantees swift and precise movements along the “Z” and “X” axes.

One of the key advantages of the LS 600M lies in ZMM Bulgaria’s dedication to achieving completeness in the manufacturing process. By producing critical components in-house and collaborating with reliable suppliers, the company ensures superior quality and timely delivery. The intuitive user interface and interactive software, developed in conjunction with Schneider Electric, enable seamless programming, even for operators without prior CNC experience.

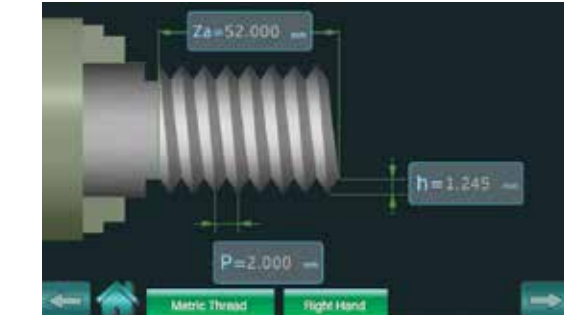

## ADVANTAGES

- Based on the controller Schneider Magelis the intelligent, self-developed ZMM Sliven software leads the operator also without programming skills simple and fast to the finished workpiece.
- The interface is simple and with large icons, which is convenient in a specific work environment.
- The intuitive menu facilitates the transition to next screens and operations.
- Well visualized and structured cyclic operations, threads and steps.
- Possibility to set-up the feeds, threads, etc. both mechanically and digitally (via the display).
- The manual, automatic and combined mode allows more precise operation compared to universal lathe.
- Easy transition from manual to automatic operation mode.

## IN SUMMERY

- Fast and simple communication between the operator and the lathe.
- Simple workpieces are machined in the same way as on the universal lathe, but more efficient.
- Complicated workpieces are machined in the same way as on the universal lathe, but faster.
- Complicated workpieces are machined in the same way as on the CNC lathe, but easier.



For illustration purpose only



For illustration purpose only



# CNC lathe LT1500 for wheelset reprofiling

We have developed the lathe model LT1500, incorporating CNC technology, specifically designed for reprofiling wagon wheels. The lathe is based on our established model, which has demonstrated its excellent functional performance through its efficient cutting process and remarkable stability. Its exceptional precision is a result of its wide body and high torques.

The machine is tailored to excel in reprofiling wagon wheels while offering the flexibility to adapt to other production programs effortlessly. Company Fagor, well-known for its expertise in such developments, supplies high-class control and drives for the machine.

The lathe incorporates two controllable axes (X and Z) and introduces an innovative additional axis for tailstock control. It integrates two 3-jaw chucks from Bison, facilitating secure fastening of wheelsets with manual tightening. Moreover, the machine incorporates a 4-position turret head from Barufaldi, which possesses a 40x40 tool section.



For illustration purpose only

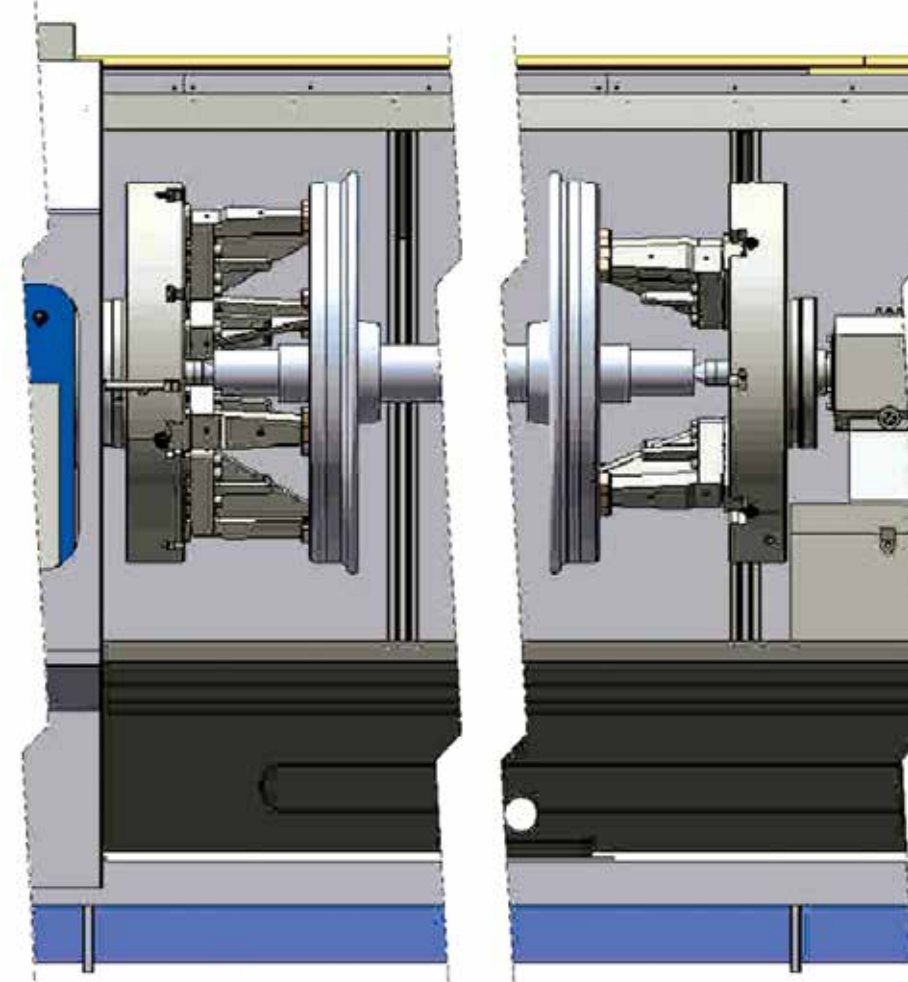

For illustration purpose only

The lathe utilizes specialized cutting tools from Iscar for reprofiling, ensuring optimal results. Precision is maintained with the help of a measuring probe from Blum, clamped in the turret head, enabling active control of preliminary wear measurements and the final characterization of reprofiled wheelsets. The LT1500 is designed with a mechanized chip conveyor to ensure a clean and efficient work area by effectively handling chip removal during operation.

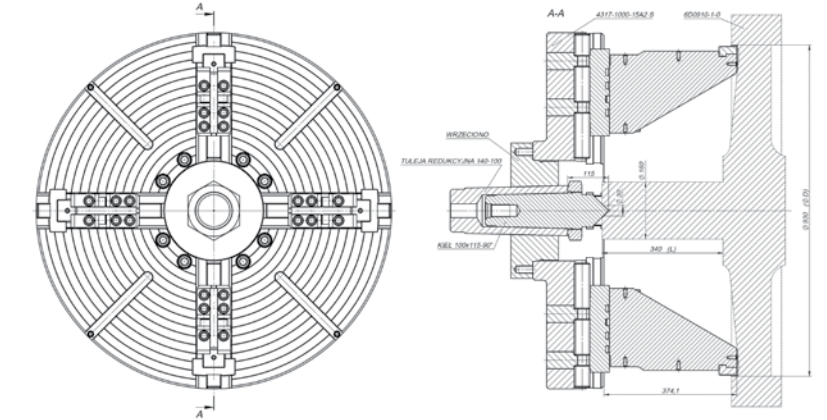

**Wheelset clamping** – fast positioning and machining stability is achieved by placing between centers and clamping with two hand-clamping faceplates – “Bison MT-5193” directly mounted on gearbox and tailstock.

# LATHE MACHINE OPTIONAL ACCESSORIES

| N  | OPTIONAL ACCESSORY                     | SPECIFICATIONS                     | CU325<br>CU325RD | C400TM<br>C400TS | CU400  | CU500   | CU400M<br>CU400MRD | CU500M<br>CU500MRD | CU580M<br>CU580MRD |
|----|--|------------------------------------|------------------|------------------|--------|---------|--------------------|--------------------|--------------------|
| 1  | MACHINE BED GAP                        |                                    | Yes              | Yes              | Yes    | Yes     | Yes                | Yes                | Yes                |
| 2  | 3-JAW SELF-CENTERING CHUCK             | Diameter (mm)                      | 160              | 200              | 250    | 250     | 250                | 250                | 250                |
| 3  | INDEPENDENT 4-JAW CHUCK                | Diameter (mm)                      | 250              | 320              | 400    | 500     | 400                | 500                | 500                |
| 4  | FACE PLATE                             | Diameter (mm)                      | 296              | 315              | 400    | 480     | 400                | 480                | 480                |
| 5  | FOLLOWER REST                          | Range (mm)                         | 10-70            | 10-80            | 15-160 | 15-200  | 15-160             | 15-200             | 15-200             |
| 6  | STEADY REST, SMALL SIZE                | Range (mm)                         | 10-70            | 10-100           | 15-150 | 15-160  | 15-150             | 15-200             | 15-200             |
| 7  | STEADY REST, BIG SIZE                  | Range (mm)                         | No               | 100 - 200        | No     | 140-280 | No                 | 140-280            | 180-340            |
| 8  | TAPER TURNING ATTACHM.                 | ±10°                               | Yes              | Yes              | Yes    | Yes     | Yes                | Yes                | Yes                |
| 9  | ONE-POSITION LONG. STOP                |                                    | Yes              | Yes              | Yes    | Yes     | Yes                | Yes                | Yes                |
| 10 | THREAD DIAL                            |                                    | Yes              | Yes              | Yes    | Yes     | Yes                | Yes                | Yes                |
| 11 | DRIVE PLATE FOR SPINDLE NOSE DIN 55027 |                                    | Yes              | Yes              | Yes    | Yes     | Yes                | Yes                | Yes                |
| 12 | SET OF LATHE DOGS                      | Ø20; Ø30; Ø40; Ø50; Ø60; Ø80; Ø100 | 20; 50;          | 20;30;40;50;60   | Full   | Full    | Full               | Full               | Full               |
| 13 | LIVE CENTER                            | Morse                              | M3               | M4               | M5     | M5      | M5                 | M5                 | M5                 |
| 14 | DRILL CHUCK WITH ARBOR                 | Drill diam. (mm)                   | 20               | 20               | 20     | 20      | 20                 | 20                 | 20                 |

Remarks : Yes = Available for this model; No = Not available for this model

Steady rest Ø720mm for lathe CU1000 – open type only

Steady rest Ø 700-1000 for lathe CU1410RD - open type only

Steady rest size placed in // refers to the model with rolling quills

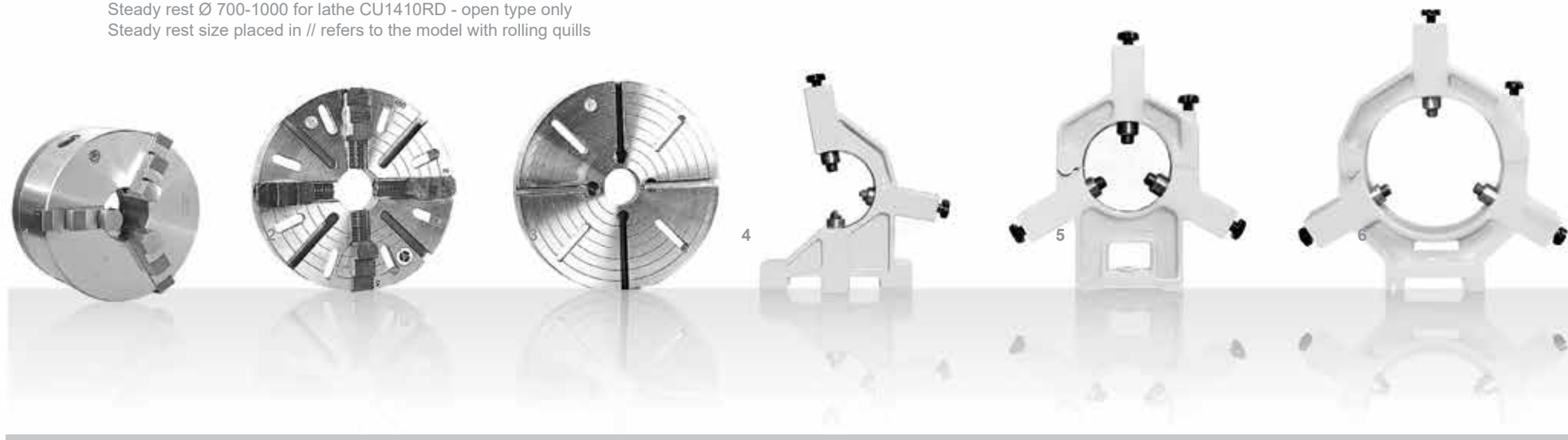

| C11MC<br>C11MCS | CU500MT<br>CU500MTRD | CU630<br>CU630RD | CU730<br>CU730RD | C10T<br>C10TS | C10TM<br>C10TMS    | C10TH<br>C10THS    | C11T.6   | C10T.10<br>C10T.10S | C10T.12<br>C10T.12S | C10T.14<br>C10T.14S | CU800<br>CU800RD | CU1000<br>CU1000RD | CU1250<br>CU1250RD            | CU1410RD                       |
|-----------------|----------------------|------------------|------------------|---------------|--------------------|--------------------|----------|---------------------|---------------------|---------------------|------------------|--------------------|-------------------------------|--------------------------------|
| Yes             | Yes                  | Yes              | Yes              | Yes           | Yes                | Yes                | Yes      | Yes                 | Yes                 | Yes                 | Yes              | Yes                | Yes                           |                                |
| 250             | 315                  | 315              | 315              | 315           | 400                | 400                | 500      | 500                 | 500                 | 660                 | 500              | 500                | 500                           | 630                            |
| 500             | 500                  | 630              | 630              | 630           | 760                | 760                | x        | 630                 | 630                 | 800                 | 760              | 1000               | 1250                          | 1250                           |
| 480             | 500                  | 600              | 600              | 600           | 760                | 760                | x        | x                   | x                   | x                   | 760              | 1000               | 1000                          | No                             |
| 20-200          | 15-200               | 15-200           | 15-200           | 20-200        | 20-200             | 20-200             | 20-200   | 20-200              | 20-200              | 20-200              | 80-300           | 80-300             | 80-300                        | 80-300                         |
| 20-200          | 15-160               | 15-200           | 15-200           | 20-200        | 20-200             | 50-250             | 20-200   | 20-200              | 20-200              | 20-200              | 50-300           | 50-300             | 50-300                        | 80-300                         |
| 180-340         | 140-280              | 180-340          | 180-430          | 180-430       | 180-430<br>200-520 | 220-450<br>420-620 | 180-340  | 180-430             | 180-430             | 180-430             | 270-520          | 270-520<br>470-720 | 270-520<br>470-720<br>700-950 | 270-520<br>470-720<br>700-1000 |
| Yes             | Yes                  | Yes              | Yes              | Yes           | Yes                | Yes                | Standard | Standard            | Standard            | Standard            | Yes              | Yes                | Yes                           | Yes                            |
| Yes             | Yes                  | Yes              | Yes              | Yes           | Yes                | Yes                | Yes      | Yes                 | Yes                 | Yes                 | Yes              | Yes                | Yes                           | No                             |
| Yes             | Yes                  | Yes              | Yes              | Yes           | Yes                | Yes                | Standard | Standard            | Standard            | Standard            | Yes              | Yes                | Yes                           | Yes                            |
| Yes             | Yes                  | Yes              | Yes              | Yes           | Yes                | Yes                | No       | No                  | No                  | No                  | No               | No                 | No                            | No                             |
| Full            | Full                 | Full             | Full             | Full          | Full               | Full               | No       | No                  | No                  | No                  | No               | No                 | No                            | No                             |
| M5              | M5                   | M5               | M5               | M6            | M6                 | M6                 | Yes      | Yes                 | Yes                 | Yes                 | M6               | M6                 | M6                            | MK 7                           |
| 20              | 20                   | 20               | 20               | N.A.          | N.A.               | N.A.               | No       | No                  | No                  | No                  | No               | No                 | No                            | No                             |





# ZMM SLIVEN

www.zmmsliven.com



ZMM Sliven is specialized in the design and manufacture of universal lathes, oil country lathes, CNC lathes, equipment and spare parts. Over 95% of the output is exported to more than 85 countries across the globe. Each machine is manufactured as per the specific climate conditions of the region where it will be operated and in consideration of the particular needs of every individual client. Products of ZMM Sliven are recognized all over the world for their long working life and quality. For the time-being, the factory has manufactured a total of over 120,000 lathes.

ZMM Sliven has adopted a comprehensive quality management system and is ISO 9001 certified. All products of ZMM Sliven also bear the CE indication as proof of conformity with the norms and requirements of the European Community.



# ZMM NOVA ZAGORA

www.zmmnz.com

ZMM Nova Zagora supplies parts and units to over 30 metal- and woodworking machine manufacturers in Europe. ZMM Nova Zagora's products and services are organized in four groups:

- ROTATION PARTS: Axes and shafts - smooth and spline; Gear-wheels; Shaft-gear wheels; Chain gear-wheels, Tooth-belt pulleys, Piston rods;
- UNITS: Multi-disk clutches; Lathe gear and slide box ; Cylindrical and worm reduction gear;

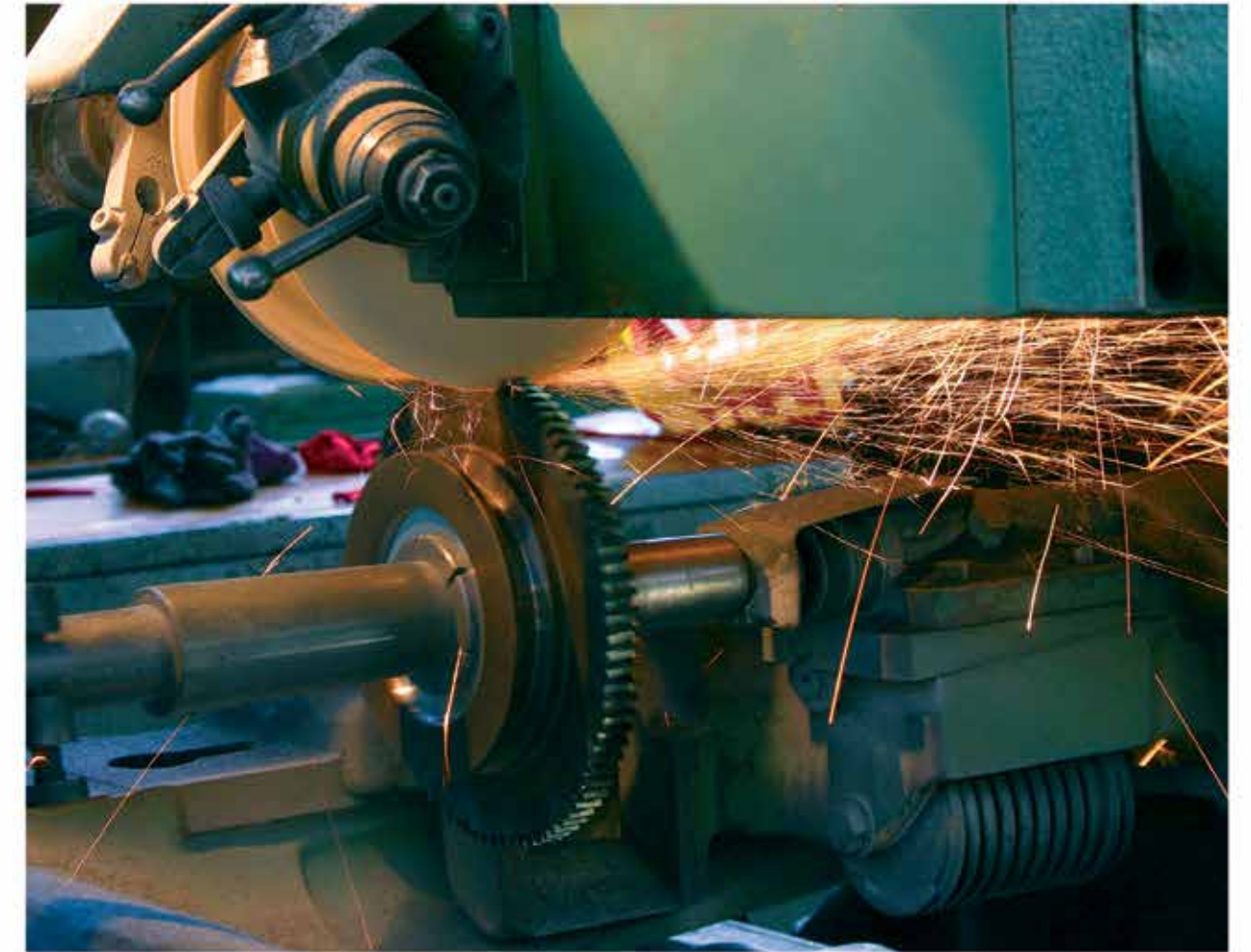

- MACHINES: Chip conveyors; Machines built in automated wood processing complexes;
- HEAT TREATMENT: Soft annealing; Inter mediate annealing; Carburize; Nitro carburize; Core hardening; Surface hardening.

ZMM Nova Zagora is the county's leading manufacturer of chip conveyors for various CNC lathes and centers. They are designed as per customer's specifications using metal hinged bands with fluted working space to transport chips with various shapes.

As of 1998 ZMM Nova Zagora is duly certified and operates as per the ISO 9001 Quality Management System.

# IHB Metal Castings

www.ihbmetalcastings.com



IHB Metal Castings is a joint stock company with majority shareholder ZMM Bulgaria Holding. The foundry is specialized in the production of castings from modified gray cast iron - according to EN 1561 and nodular cast iron - according to EN 1563. Castings can be with medium and high degree of complexity in single and small series with single weights in the following ranges:

- Gray cast iron: from 80 to 8 000 kg per unit;
- Nodular cast iron: from 50 to 3 000 kg per unit;

The foundry is also capable of providing a wide range of wooden patterns and cores with accuracy from GTB17 to GTB18 according to DIN1685.

IHB Metal Castings supplies a large variety of castings including the full range of components for machine tools - bodies, bed slides, columns, tailstocks, boxes etc. It is certified according to ISO 9001.

| Type                | Swing over bed | Swing over cross slide | Swing in gap* | Spindle bore | Width of bed | Max RPM   |            |          | Distance between centers |     |      |      |      |      |      |      |      |      | Page |      |       |  |  |       |
|---------------------|----------------|------------------------|---------------|--------------|--------------|-----------|------------|----------|--------------------------|-----|------|------|------|------|------|------|------|------|------|------|-------|--|--|-------|
|                     |                |                        |               |              |              | Universal | Variable   | CNC      | For Variable Speed types |     |      |      |      |      |      |      |      |      |      |      |       |  |  |       |
| CU325/CU325RD       | 325            | 190                    | 440           | 32           | 200          | 2000      | 2200       | –        | 500                      | 750 | 1000 |      |      |      |      |      |      |      |      |      |       |  |  | 5/21  |
| C400TM              | 400            | 235                    | 550           | 52           | 320          | 2240      | –          | –        |                          | 750 | 1000 | 1500 |      |      |      |      |      |      |      |      |       |  |  | 7     |
| C400TS              | 400            | 235                    | 550           | 52           | 320          | –         | 2120       | –        |                          | 750 | 1000 | 1500 |      |      |      |      |      |      |      |      |       |  |  | 23    |
| CU400               | 440            | 230                    | 620           | 62           | 360          | 2000      | –          | –        |                          |     | 1000 | 1500 | 2000 |      |      |      |      |      |      |      |       |  |  | 9     |
| CU500               | 500            | 300                    | 670           | 62           | 360          | 2000      | –          | –        |                          |     | 1000 | 1500 | 2000 |      |      |      |      |      |      |      |       |  |  | 9     |
| CU400M/CU400MRD     | 440            | 240                    | 640           | 72           | 400          | 2000      | 2000       | –        |                          |     | 1000 | 1500 | 2000 | 3000 | 4000 | 5000 |      |      |      |      |       |  |  | 11/25 |
| CU500M/CU500MRD     | 500            | 300                    | 700           | 72           | 400          | 2000      | 2000       | –        |                          |     | 1000 | 1500 | 2000 | 3000 | 4000 | 5000 |      |      |      |      |       |  |  | 11/25 |
| CU580M/CU580MRD     | 580            | 380                    | 780           | 72           | 400          | 2000      | 2000       | –        |                          |     | 1000 | 1500 | 2000 | 3000 | 4000 | 5000 |      |      |      |      |       |  |  | 11/25 |
| C11MC/C11MCS        | 600            | 400                    | 800           | 80           | 400          | 2000      | 2000       | –        |                          |     | 1000 | 1500 | 2000 | 3000 | 4000 | 5000 |      |      |      |      |       |  |  | 13/27 |
| CU500MT/CU500MTRD   | 500            | 300                    | 700           | 103          | 400          | 1400      | 1400       | –        |                          |     | 1000 | 1500 | 2000 | 3000 | 4000 | 5000 |      |      |      |      |       |  |  | 15/29 |
| CU630/CU630RD       | 630            | 430                    | 830           | 103          | 400          | 1250      | 1250       | –        |                          |     | 1000 | 1500 | 2000 | 3000 | 4000 | 5000 |      |      |      |      |       |  |  | 15/29 |
| CU730/CU730RD       | 730            | 500                    | 930           | 103          | 400          | 1250      | 1250       | –        |                          |     | 1000 | 1500 | 2000 | 3000 | 4000 | 5000 |      |      |      |      |       |  |  | 15/29 |
| C10T/C10TS          | 660            | 420                    | 850           | 103          | 560          | 1320      | 1320       | –        |                          |     |      | 1500 | 2000 | 3000 | 4000 | 5000 | 6000 |      |      |      |       |  |  | 17/31 |
| C10TM/C10TMS        | 760            | 520                    | 950           | 132          | 560          | 1015      | 1250       | –        |                          |     |      | 1500 | 2000 | 3000 | 4000 | 5000 | 6000 |      |      |      |       |  |  | 17/31 |
| C10TH/C10THS        | 860            | 620                    | 1050          | 132          | 560          | 1015      | 1250       | –        |                          |     |      | 1500 | 2000 | 3000 | 4000 | 5000 | 6000 |      |      |      |       |  |  | 17/31 |
| CU800/CU800RD       | 890            | 490                    | 1050          | 155          | 700          | 1250      | 1000       | –        |                          |     |      | 1500 | 2000 | 3000 | 4000 | 5000 | 6000 | 7000 | 8000 | 9000 | 10000 |  |  | 19/33 |
| CU1000/CU1000RD     | 1090           | 690                    | 1250          | 155          | 700          | 1250      | 1000       | –        |                          |     |      | 1500 | 2000 | 3000 | 4000 | 5000 | 6000 | 7000 | 8000 | 9000 | 10000 |  |  | 19/33 |
| CU1250/CU1250RD     | 1320           | 940                    | 1500          | 155          | 700          | 1000      | 1000       | –        |                          |     |      | 1500 | 2000 | 3000 | 4000 | 5000 | 6000 | 7000 | 8000 | 9000 | 10000 |  |  | 19/33 |
| CU1410RD            | 1410           | 1000                   | –             | 205          | 800          | –         | 500        | –        |                          |     |      |      | 2000 | 3000 | 4000 | 5000 | 6000 | 7000 | 8000 | 9000 |       |  |  | 35    |
| LT580               | 580            | 380                    | –             | 72           | 400          | –         | ranges 3   | 2000     |                          |     | 1000 | 1500 | 2000 | 3000 | 4000 | 5000 |      |      |      |      |       |  |  | 43    |
| LT660               | 660            | 420                    | –             | 103          | 560          | –         | ranges 3   | 1320     |                          |     |      | 1500 | 2000 | 3000 | 4000 | 5000 | 6000 |      |      |      |       |  |  | 45    |
| LT760               | 760            | 520                    | –             | 132          | 560          | –         | ranges 3   | 1250     |                          |     |      | 1500 | 2000 | 3000 | 4000 | 5000 | 6000 |      |      |      |       |  |  | 45    |
| LT860               | 860            | 620                    | –             | 132          | 560          | –         | ranges 3   | 1250     |                          |     |      | 1500 | 2000 | 3000 | 4000 | 5000 | 6000 |      |      |      |       |  |  | 45    |
| LT800/LCC800        | 890            | 490                    | –             | 155          | 700          | –         | ranges 4/2 | 1000/700 |                          |     |      | 1500 |      | 3000 | 4000 | 5000 | 6000 |      |      |      |       |  |  | 51/55 |
| LT1000/LCC1000      | 1090           | 690                    | –             | 155          | 700          | –         | ranges 4/2 | 1000/700 |                          |     |      | 1500 |      | 3000 | 4000 | 5000 | 6000 |      |      |      |       |  |  | 51/55 |
| LT1250/LCC1250      | 1320           | 940                    | –             | 155          | 700          | –         | ranges 4/2 | 1000/700 |                          |     |      | 1500 |      | 3000 | 4000 | 5000 | 6000 |      |      |      |       |  |  | 51/55 |
| Oil country lathes  |                |                        |               |              |              |           |            |          |                          |     |      |      |      |      |      |      |      |      |      |      |       |  |  |       |
| C11T.6              | 730            | 500                    | 930           | 155          | 400          | 800       | –          | –        |                          |     |      | 1500 | 2000 | 3000 | 4000 | 5000 |      |      |      |      |       |  |  | 37    |
| C10T.10/LTC10T.10   | 800            | 560                    | 990           | 315          | 560          | 400       | ranges 4   | 400      |                          |     |      | 1500 | 2000 | 3000 | 4000 | 5000 | 6000 |      |      |      |       |  |  | 37/47 |
| C10T.12/LTC10T.12   | 800            | 560                    | 990           | 315          | 560          | 400       | ranges 4   | 400      |                          |     |      | 1500 | 2000 | 3000 | 4000 | 5000 | 6000 |      |      |      |       |  |  | 37/47 |
| C10T.14 / LTC10T.14 | 1020           | 770                    | 1200          | 358          | 560          | 315       | ranges 4   | 315      |                          |     |      | 1500 | 2000 | 3000 | 4000 | 5000 | 6000 |      |      |      |       |  |  | 39    |

\* With option machine bed gap





79 Knyaginya Maria Luiza Blvd, fl. 4  
1202 Sofia, Bulgaria  
tel.: +359 2 980 12 38, 981 07 53, 981 15 06  
fax: +359 2 981 43 14  
e-mail: [office@zmmbulgaria.com](mailto:office@zmmbulgaria.com)  
[www.zmmbulgaria.com](http://www.zmmbulgaria.com)

79 Knyaginya Maria Luiza Blvd, fl. 3  
1202 Sofia, Bulgaria  
tel.: +359 2 980 71 01, 981 55 06  
fax: +359 2 980 70 72  
e-mail: [office@bulgariaholding.com](mailto:office@bulgariaholding.com)  
[www.bulgariaholding.com](http://www.bulgariaholding.com)

